

EN

User Manual

# USER MANUAL

Oven

ZOB35302

**ZANUSSI**

## Contents

---

Safety information.....	2	Additional functions.....	9
Safety instructions.....	3	Hints and tips.....	9
Product description.....	5	Care and cleaning.....	15
Before first use.....	5	Troubleshooting.....	16
Daily use.....	6	Installation.....	17
Clock functions.....	7	Energy efficiency.....	19
Using the accessories.....	8		

Subject to change without notice.

## Safety information

---

Before the installation and use of the appliance, carefully read the supplied instructions. The manufacturer is not responsible if an incorrect installation and use causes injuries and damages. Always keep the instructions with the appliance for future reference.

### Children and vulnerable people safety

- This appliance can be used by children aged from 8 years and above and persons with reduced physical, sensory or mental capabilities or lack of experience and knowledge if they have been given supervision or instruction concerning use of the appliance in a safe way and understand the hazards involved.
- Do not let children play with the appliance.
- Keep all packaging away from children.
- Keep children and pets away from the appliance when it operates or when it cools down. Accessible parts are hot.
- If the appliance has a child safety device, we recommend you activate it.
- Cleaning and user maintenance shall not be made by children without supervision.
- Children of less than 3 years should be kept away unless continuously supervised.

### General Safety

- Only a qualified person must install this appliance and replace the cable.

- Internally the appliance becomes hot when in operation. Do not touch the heating elements that are in the appliance. Always use oven gloves to remove or put in accessories or ovenware.
- Before maintenance cut the power supply.
- Ensure that the appliance is switched off before replacing the lamp to avoid the possibility of electric shock.
- Do not use a steam cleaner to clean the appliance.
- Do not use harsh abrasive cleaners or sharp metal scrapers to clean the glass door since they can scratch the surface, which may result in shattering of the glass.
- If the supply cord is damaged, it must be replaced by the manufacturer, its Authorised Service Centre or similarly qualified persons in order to avoid a hazard.
- The means for disconnection must be incorporated in the fixed wiring in accordance with the wiring rules.

## Safety instructions

---

### Installation



#### **WARNING!**

Only a qualified person must install this appliance.

- Remove all the packaging.
- Do not install or use a damaged appliance.
- Obey the installation instruction supplied with the appliance.
- Always be careful when you move the appliance because it is heavy. Always wear safety gloves.
- Do not pull the appliance by the handle.
- Keep the minimum distance from the other appliances and units.
- Make sure that the appliance is installed below and adjacent safe structures.
- The sides of the appliance must stay adjacent to appliances or to units with the same height.

### Electrical connection



#### **WARNING!**

Risk of fire and electrical shock.

- All electrical connections should be made by a qualified electrician.
- The appliance must be earthed.

- Make sure that the electrical information on the rating plate agrees with the power supply. If not, contact an electrician.
- Always use a correctly installed shockproof socket.
- Do not use multi-plug adapters and extension cables.
- Make sure not to cause damage to the mains plug and to the mains cable. Should the mains cable need to be replaced, this must be carried out by our Authorised Service Centre.
- Do not let mains cables touch or come near the appliance door, especially when the door is hot.
- The shock protection of live and insulated parts must be fastened in such a way that it cannot be removed without tools.
- Connect the mains plug to the mains socket only at the end of the installation. Make sure that there is access to the mains plug after the installation.
- If the mains socket is loose, do not connect the mains plug.
- Do not pull the mains cable to disconnect the appliance. Always pull the mains plug.
- Use only correct isolation devices: line protecting cut-outs, fuses (screw type fuses removed from the holder), earth leakage trips and contactors.

- The electrical installation must have an isolation device which lets you disconnect the appliance from the mains at all poles. The isolation device must have a contact opening width of minimum 3 mm.
- This appliance complies with the E.E.C. Directives.

## Use



### WARNING!

Risk of injury, burns and electrical shock or explosion.

- Use this appliance in a household only.
- Do not change the specification of this appliance.
- Make sure that the ventilation openings are not blocked.
- Do not let the appliance stay unattended during operation.
- Deactivate the appliance after each use.
- Be careful when you open the appliance door while the appliance is in operation. Hot air can release.
- Do not operate the appliance with wet hands or when it has contact with water.
- Do not apply pressure on the open door.
- Do not use the appliance as a work surface or as a storage surface.
- Open the appliance door carefully. The use of ingredients with alcohol can cause a mixture of alcohol and air.
- Do not let sparks or open flames to come in contact with the appliance when you open the door.
- Do not put flammable products or items that are wet with flammable products in, near or on the appliance.



### WARNING!

Risk of damage to the appliance.

- To prevent damage or discoloration to the enamel:
  - do not put ovenware or other objects in the appliance directly on the bottom.
  - do not put aluminium foil directly on the bottom of the appliance.
  - do not put water directly into the hot appliance.
  - do not keep moist dishes and food in the appliance after you finish the cooking.
  - be careful when you remove or install the accessories.

- Discoloration of the enamel has no effect on the performance of the appliance. It is not a defect in the sense of the warranty law.
- Use a deep pan for moist cakes. Fruit juices cause stains that can be permanent.
- This appliance is for cooking purposes only. It must not be used for other purposes, for example room heating.
- Always cook with the oven door closed.
- If the appliance is installed behind a furniture panel (e.g. a door) make sure the door is never closed when the appliance is in operation. Heat and moisture can build up behind a closed furniture panel and cause subsequent damage to the appliance, the housing unit or the floor. Do not close the furniture panel until the appliance has cooled down completely after use.

## Care and cleaning



### WARNING!

Risk of injury, fire, or damage to the appliance.

- Before maintenance, deactivate the appliance and disconnect the mains plug from the mains socket.
- Make sure the appliance is cold. There is the risk that the glass panels can break.
- Replace immediately the door glass panels when they are damaged. Contact the Authorised Service Centre.
- Be careful when you remove the door from the appliance. The door is heavy!
- Clean regularly the appliance to prevent the deterioration of the surface material.
- Remaining fat or food in the appliance can cause fire.
- Clean the appliance with a moist soft cloth. Only use neutral detergents. Do not use abrasive products, abrasive cleaning pads, solvents or metal objects.
- If you use an oven spray, obey the safety instructions on the packaging.
- Do not clean the catalytic enamel (if applicable) with any kind of detergent.

## Internal light

- The type of light bulb or halogen lamp used for this appliance is only for household appliances. Do not use it for house lighting.



### WARNING!

Risk of electrical shock.

- Before replacing the lamp, disconnect the appliance from the power supply.
- Only use lamps with the same specifications.

## Disposal



### WARNING!

Risk of injury or suffocation.

- Disconnect the appliance from the mains supply.

## Product description

### General overview

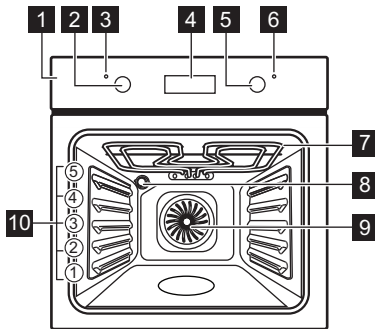

- Cut off the mains cable and discard it.
- Remove the door catch to prevent children and pets to get closed in the appliance.

## Service

- To repair the appliance contact an Authorised Service Centre.
- Use original spare parts only.

- 1** Control panel
- 2** Knob for the oven functions
- 3** Power lamp / symbol / indicator
- 4** Electronic programmer
- 5** Knob for the temperature
- 6** Temperature lamp / symbol / indicator
- 7** Heating element
- 8** Lamp
- 9** Fan
- 10** Shelf positions

## Accessories

- **Wire shelf**  
For cookware, cake tins, roasts.
- **Grill- / Roasting pan**  
To bake and roast or as pan to collect fat.

## Trivet

For roasting and grilling.



Use the trivet only with the Grill- / roasting pan.

## Before first use



### WARNING!

Refer to Safety chapters.

## Initial Cleaning

Remove all accessories from the appliance.



Refer to "Care and cleaning" chapter.

Clean the appliance before first use.  
Put the accessories back to their initial position.

## Setting the time



You must set the time before you operate the oven.

The indicator for the Time of day function flashes when you connect the appliance to the electrical supply, when there was a power cut or when the timer is not set.

Press the **+** or **-** button to set the correct time.

After approximately five seconds, the flashing stops and the display shows the time of day you set.

## Changing the time

 You cannot change the time of day if the Duration  or End  function operates.

Press  again and again until the indicator for the Time of Day function flashes.

To set a new time, refer to "Setting the time".

## Preheating

Preheat the empty appliance to burn off the remaining grease.

## Daily use



### WARNING!

Refer to Safety chapters.

## Retractable knobs

To use the appliance, press the control knob. The control knob comes out.



## Activating and deactivating the appliance





**It depends on the model if your appliance has knob symbols, indicators or lamps:**



- The indicator comes on when the oven heats up.
- The lamp comes on when the appliance operates.
- The symbol shows whether the knob controls the oven functions or the temperature.

## Oven functions

Oven function		Application
	Off position	The appliance is off.
	Light	To activate the lamp without a cooking function.
	Defrost	To defrost frozen food.

1. Set the function  and the maximum temperature.
2. Let the appliance operate for 1 hour.
3. Set the function  and set the maximum temperature.
4. Let the appliance operate for 15 minutes. Accessories can become hotter than usual. The appliance can emit an odour and smoke. This is normal. Make sure that the airflow in the room is sufficient.

1. Turn the knob for the oven functions to select an oven function.
2. Turn the knob for the temperature to select a temperature.
3. To deactivate the appliance turn the knobs for the oven functions and temperature to the off position.

Oven function		Application
	True Fan Cooking	To bake on up to 3 shelf positions at the same time and to dry food.
	Grilling	To grill flat food and to toast bread.

## Display

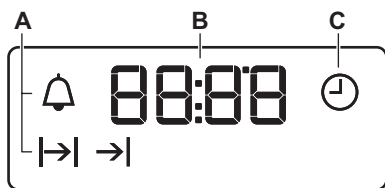





- A) Function indicators
- B) Time display
- C) Function indicator

## Buttons

Button	Function	Description
—	MINUS	To set the time.
	CLOCK	To set a clock function.
+	PLUS	To set the time.

## Clock functions

### Clock functions table

Clock function		Application
	Time of day	To set, change or check the time of day.
	Minute Minder	To set countdown time. This function has no effect on the operation of the appliance.
	Duration	To set the cooking time of the oven.
	End	To set the time of day when the oven should deactivate.

- i** You can use the functions Duration  $\rightarrow$  and End  $\rightarrow$  at the same time to set the time for how long the appliance should operate and when the appliance should deactivate. This lets you activate the appliance with a delay in time. First set the Duration  $\rightarrow$  and then the End  $\rightarrow$ .

### Setting the clock functions

For Duration  $\rightarrow$  and End  $\rightarrow$ , set an oven function and temperature of cooking. This is not necessary for the Minute Minder  $\triangle$ .

1. Press  $\text{⌚}$  again and again until the indicator for the necessary clock function starts to flash.
2. Press  $+$  or  $-$  to set the time for the necessary clock function.

The clock function operates. The display shows the indicator for the clock function you set.

### Using the accessories

- !** **WARNING!**  
Refer to Safety chapters.

#### Trivet and Grill- / Roasting pan

- !** **WARNING!**  
Be careful when you remove the accessories from a hot appliance. There is a risk of burns.

You can use the trivet to roast larger pieces of meat or poultry on one shelf position.

1. Put the trivet into the deep pan so that the supports of the wire shelf point up.

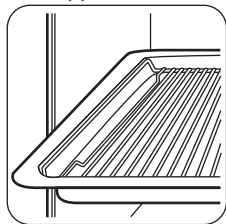

- i** For the Minute Minder function the display shows the time left.
3. When the time ends the indicator of the clock function flashes and an acoustic signal sounds. Press a button to stop the signal.
  4. Turn the knob for the oven functions and the knob for the temperature to the off position.

- i** With the Duration  $\rightarrow$  and End  $\rightarrow$  functions, the appliance deactivates automatically.

### Cancelling the clock functions

1. Press the  $\text{⌚}$  again and again until the necessary function indicator flashes.
2. Press and hold  $-$ .  
The clock function goes out after some seconds.

2. Put the deep pan into the oven on the necessary shelf position.  
You can use the trivet to grill flat dishes in large quantities and to toast.

1. Put the trivet into the deep pan so that the supports of the wire shelf point down.

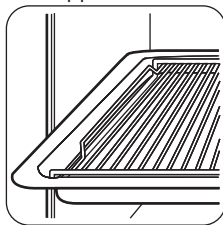

2. Put the deep pan into the oven on the necessary shelf position.



## Additional functions

---

### Cooling fan

When the appliance operates, the cooling fan activates automatically to keep the surfaces of the appliance cool. If you deactivate the appliance, the cooling fan can continue to operate until the appliance cools down.

## Hints and tips

---



### WARNING!

Refer to Safety chapters.



The temperature and baking times in the tables are guidelines only. They depend on the recipes and the quality and quantity of the ingredients used.

### General information

- The appliance has five shelf positions. Count the shelf positions from the bottom of the appliance floor.
- The appliance has a special system which circulates the air and constantly recycles the steam. With this system you can cook in a steamy environment and keep the food soft inside and crusty outside. It decreases the cooking time and energy consumption to a minimum.
- Moisture can condense in the appliance or on the door glass panels. This is normal. Always stand back from the appliance when you open the appliance door while cooking. To decrease the condensation, operate the appliance for 10 minutes before cooking.
- Clean the moisture after each use of the appliance.
- Do not put the objects directly on the appliance floor and do not put aluminium foil

### Safety thermostat

Incorrect operation of the appliance or defective components can cause dangerous overheating. To prevent this, the oven has a safety thermostat which interrupts the power supply. The oven activates again automatically when the temperature drops.

on the components when you cook. This can change the baking results and cause damage to the enamel.

### Baking cakes

- Do not open the oven door before 3/4 of the set cooking time is up.
- If you use two baking trays at the same time, keep one empty level between them.

### Cooking meat and fish

- Use a deep pan for very fatty food to prevent the oven from stains that can be permanent.
- Leave the meat for approximately 15 minutes before carving so that the juice does not seep out.
- To prevent too much smoke in the oven during roasting, add some water into the deep pan. To prevent the smoke condensation, add water each time after it dries up.

### Cooking times

Cooking times depend on the type of food, its consistency, and volume.

Initially, monitor the performance when you cook. Find the best settings (heat setting, cooking time, etc.) for your cookware, recipes and quantities when you use this appliance.

## Baking and roasting table

### Cakes

Food	True Fan Cooking		Time (min)	Comments
	Temperature (°C)	Shelf position		
Whisked recipes	160	3 (2 and 4)	45 - 60	In a cake mould
Shortbread dough	160	3 (2 and 4)	20 - 30	In a cake mould
Buttermilk cheese-cake	165	2	60 - 80	In a 26 cm cake mould
Apple cake (Apple pie) <sup>1)</sup>	160	2 (left and right)	80 - 100	In two 20 cm cake moulds on a wire shelf
Strudel	150	2	60 - 80	In a baking tray
Jam-tart	165	2 (left and right)	30 - 40	In a 26 cm cake mould
Sponge cake	160	2	50 - 60	In a 26 cm cake mould
Christmas cake / Rich fruit cake <sup>1)</sup>	150	2	90 - 120	In a 20 cm cake mould
Plum cake <sup>1)</sup>	160	2	50 - 60	In a bread tin
Small cakes - one level	140 - 150	3	20 - 30	In a baking tray
Small cakes - two levels	140 - 150	2 and 4	25 - 35	In a baking tray
Small cakes - three levels	140 - 150	1, 3 and 5	30 - 45	In a baking tray
Biscuits / pastry stripes - one level	140 - 150	3	30 - 35	In a baking tray
Biscuits / pastry stripes - two levels	140 - 150	2 and 4	35 - 40	In a baking tray
Biscuits / pastry stripes - three levels	140 - 150	1, 3 and 5	35 - 45	In a baking tray
Meringues - one level	120	3	80 - 100	In a baking tray
Meringues- two levels <sup>1)</sup>	120	2 and 4	80 - 100	In a baking tray

Food	True Fan Cooking		Time (min)	Comments
	Temperature (°C)	Shelf position		
Buns <sup>1)</sup>	190	3	12 - 20	In a baking tray
Eclairs - one level	170	3	25 - 35	In a baking tray
Eclairs - two levels	170	2 and 4	35 - 45	In a baking tray
Plate tarts	170	2	45 - 70	In a 20 cm cake mould
Rich fruit cake	150	2	110 - 120	In a 24 cm cake mould
Victoria sandwich	160	2 (left and right)	50 - 60	In a 20 cm cake mould

1) Preheat the oven for 10 minutes.

### Bread and pizza

Food	True Fan Cooking		Time (min)	Comments
	Temperature (°C)	Shelf position		
White bread <sup>1)</sup>	190	1	60 - 70	1 - 2 pieces, 500 gr per piece
Rye bread	180	1	30 - 45	In a bread tin
Bread rolls <sup>1)</sup>	180	2 (2 and 4)	25 - 40	6 - 8 rolls in a baking tray
Pizza <sup>1)</sup>	230 - 250	1	10 - 20	In a baking tray or a deep pan
Scones <sup>1)</sup>	190	3	10 - 20	In a baking tray

1) Preheat the oven for 10 minutes.

### Flans

Food	True Fan Cooking		Time (min)	Comments
	Temperature (°C)	Shelf position		
Pasta flan	180	2	40 - 50	In a mould
Vegetable flan	175	2	45 - 60	In a mould
Quiches <sup>1)</sup>	180	1	50 - 60	In a mould

Food	True Fan Cooking		Time (min)	Comments
	Temperature (°C)	Shelf position		
Lasagne <sup>1)</sup>	180 - 190	2	25 - 40	In a mould
Cannelloni <sup>1)</sup>	180 - 190	2	25 - 40	In a mould

1) Preheat the oven for 10 minutes.

## Meat

Food	True Fan Cooking		Time (min)	Comments
	Temperature (°C)	Shelf position		
Beef	190	2	50 - 70	On a wire shelf
Pork	180	2	90 - 120	On a wire shelf
Veal	175	2	90 - 120	On a wire shelf
English roast beef, rare	200	2	50 - 60	On a wire shelf
English roast beef, medium	200	2	60 - 70	On a wire shelf
English roast beef, well done	200	2	70 - 75	On a wire shelf
Shoulder of pork	170	2	120 - 150	With rind
Shin of pork	160	2	100 - 120	2 pieces
Lamb	175	2	110 - 130	Leg
Chicken	200	2	70 - 85	Whole
Turkey	160	2	210 - 240	Whole
Duck	220	2	120 - 150	Whole
Goose	160	1	150 - 200	Whole
Rabbit	175	2	60 - 80	Cut in pieces
Hare	175	2	150 - 200	Cut in pieces
Pheasant	175	2	90 - 120	Whole

## Fish

Food	True Fan Cooking		Time (min)	Comments
	Temperature (°C)	Shelf position		
Trout / Sea bream	175	2	40 - 55	3 - 4 fish
Tuna fish / Salmon	175	2	35 - 60	4 - 6 fillets

## Grilling



Preheat the empty oven for 3 minutes before cooking.

Food	Quantity		Temperature (°C)	Time (min)		Shelf position
	Pieces	(g)		1st side	2nd side	
Fillet steaks	4	800	max.	12 - 15	12 - 14	4
Beef steaks	4	600	max.	10 - 12	6 - 8	4
Sausages	8	-	max.	12 - 15	10 - 12	4
Pork chops	4	600	max.	12 - 16	12 - 14	4
Chicken (cut in 2)	2	1000	max.	30 - 35	25 - 30	4
Kebabs	4	-	max.	10 - 15	10 - 12	4
Breast of chicken	4	400	max.	12 - 15	12 - 14	4
Hamburger	6	600	max.	20 - 30	-	4
Fish fillet	4	400	max.	12 - 14	10 - 12	4
Toasted sandwiches	4 - 6	-	max.	5 - 7	-	4
Toast	4 - 6	-	max.	2 - 4	2 - 3	4

## Defrost

Food	Quantity (g)	Defrosting time (min)	Further defrosting time (min)	Comments
Chicken	1000	100 - 140	20 - 30	Place the chicken on an up-turned saucer placed on a large plate. Turn halfway through.

Food	Quantity (g)	Defrosting time (min)	Further defrosting time (min)	Comments
Meat	1000	100 - 140	20 - 30	Turn halfway through.
Meat	500	90 - 120	20 - 30	Turn halfway through.
Trout	150	25 - 35	10 - 15	-
Strawberries	300	30 - 40	10 - 20	-
Butter	250	30 - 40	10 - 15	-
Cream	2 x 200	80 - 100	10 - 15	Cream can also be whipped when still slightly frozen in places.
Gateau	1400	60	60	-

### Drying - True Fan Cooking

- Cover trays with grease proof paper or baking parchment.
- For a better result, stop the oven halfway through the drying time, open the door and

let it cool down for one night to complete the drying.

### Vegetables

Food	Temperature (°C)	Time (h)	Shelf position	
			1 position	2 positions
Beans	60 - 70	6 - 8	3	1 / 4
Peppers	60 - 70	5 - 6	3	1 / 4
Vegetables for sour	60 - 70	5 - 6	3	1 / 4
Mushrooms	50 - 60	6 - 8	3	1 / 4
Herbs	40 - 50	2 - 3	3	1 / 4

### Fruit

Food	Temperature (°C)	Time (h)	Shelf position	
			1 position	2 positions
Plums	60 - 70	8 - 10	3	1 / 4
Apricots	60 - 70	8 - 10	3	1 / 4
Apple slices	60 - 70	6 - 8	3	1 / 4
Pears	60 - 70	6 - 9	3	1 / 4

## Care and cleaning



### WARNING!

Refer to Safety chapters.

### Notes on cleaning

- Clean the front of the appliance with a soft cloth with warm water and a cleaning agent.
- To clean metal surfaces, use a usual cleaning agent.
- Clean the appliance interior after each use. Fat accumulation or other food remains may result in a fire. The risk is higher for the grill pan.
- Clean stubborn dirt with a special oven cleaner.
- Clean all accessories after each use and let them dry. Use a soft cloth with warm water and a cleaning agent.
- If you have nonstick accessories, do not clean them using aggressive agents, sharp-edged objects or a dishwasher. It can cause damage to the nonstick coating.

### Stainless steel or aluminium appliances



Clean the oven door with a wet sponge only. Dry it with a soft cloth. Do not use steel wool, acids or abrasive materials as they can damage the oven surface. Clean the oven control panel with the same precautions.

### Cleaning the door gasket

- Regularly do a check of the door gasket. The door gasket is around the frame of the oven cavity. Do not use the appliance if the door gasket is damaged. Contact an Authorised Service Centre.
- To clean the door gasket, refer to the general information about cleaning.

### Cleaning the oven door

The oven door has two glass panels. You can remove the oven door and the internal glass panel to clean it.



The oven door can close if you try to remove the internal glass panel before you remove the oven door.



### CAUTION!

Do not use the appliance without the internal glass panel.

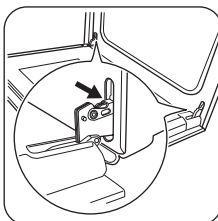

- 1** Open the door fully and hold the two door hinges.

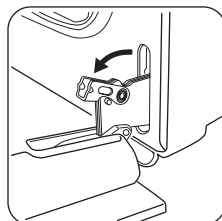

- 2** Lift and turn the levers on the two hinges.

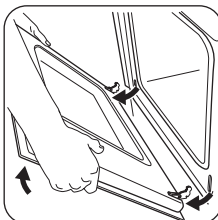

- 3** Close the oven door halfway to the first opening position. Then pull forward and remove the door from its seat.

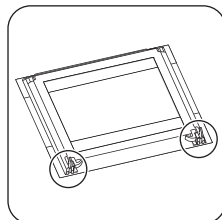

- 4** Put the door on a soft cloth on a stable surface.

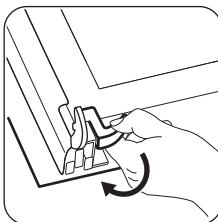

- 5** Release the locking system to remove the internal glass panel.

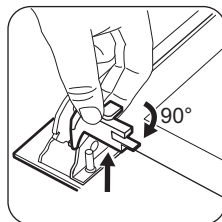

- 6** Turn the two fasteners by 90° and remove them from their seats.

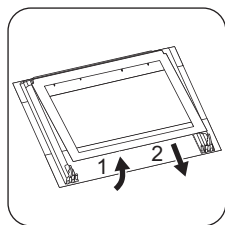

- 7** First lift carefully and then remove the glass panel.

Clean the glass panel with water and soap. Dry the glass panel carefully.

When the cleaning is completed, install the glass panel and the oven door. Do the above steps in the opposite sequence.

The screen-printing zone must face the inner side of the door. Make sure that after the installation the surface of the glass panel frame on the screen-printing zones is not rough when you touch it.

Make sure that you install the internal glass panel in the seats correctly.

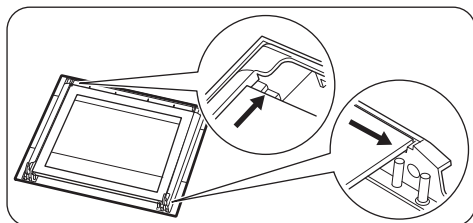

## Replacing the lamp

Put a cloth on the bottom of the interior of the appliance. It prevents damage to the lamp glass cover and the cavity.

## Troubleshooting



### WARNING!

Refer to Safety chapters.

### What to do if...

Problem	Possible cause	Remedy
The oven does not heat up.	The oven is deactivated.	Activate the oven.



### WARNING!

Danger of electrocution! Disconnect the fuse before you replace the lamp.

The lamp and the lamp glass cover can be hot.



### CAUTION!

Always hold the halogen lamp with a cloth to prevent grease residue from burning on the lamp.

1. Deactivate the appliance.
2. Remove the fuses from the fuse box or deactivate the circuit breaker.

### The back lamp

1. Turn the lamp glass cover counterclockwise to remove it.
2. Clean the glass cover.
3. Replace the lamp with a suitable 300 °C heat-resistant lamp.
4. Install the glass cover.

### The side lamp

1. Remove the left shelf support to get access to the lamp.
2. Use a narrow, blunt object (e.g. a teaspoon) to remove the glass cover.
3. Clean the glass cover.
4. Replace the lamp with a suitable 300 °C heat-resistant lamp.
5. Install the glass cover.
6. Install the left shelf support.



Problem	Possible cause	Remedy
The oven does not heat up.	The clock is not set.	Set the clock.
The oven does not heat up.	The necessary settings are not set.	Make sure that the settings are correct.
The oven does not heat up.	The fuse is released.	Make sure that the fuse is the cause of the malfunction. If the fuse releases again and again, contact a qualified electrician.
The lamp does not operate.	The lamp is defective.	Replace the lamp.
Steam and condensation settle on the food and in the cavity of the oven.	You left the dish in the oven for too long.	Do not leave the dishes in the oven for longer than 15 - 20 minutes after the cooking process ends.
The display shows "12.00".	There was a power cut.	Reset the clock.

### Service data

If you cannot find a solution to the problem yourself, contact your dealer or an Authorised Service Centre.

The necessary data for the service centre is on the rating plate. The rating plate is on the front frame of the appliance cavity. Do not remove the rating plate from the appliance cavity.

#### We recommend that you write the data here:

Model (MOD.)	.....
Product number (PNC)	.....
Serial number (S.N.)	.....

## Installation



### WARNING!

Refer to Safety chapters.

## Building In

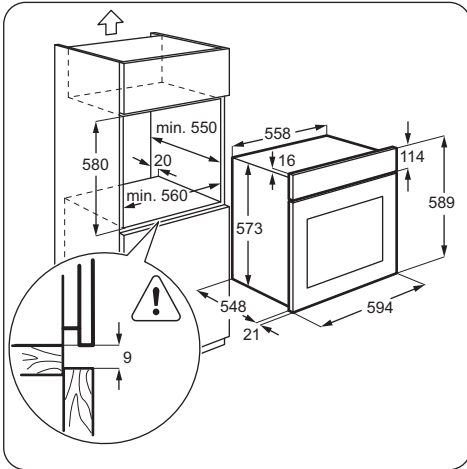
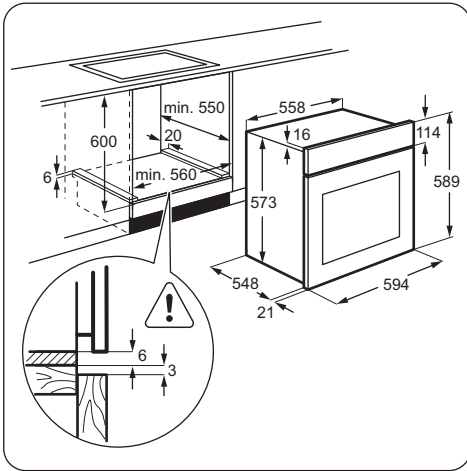

Applicable types of cables for UK only

Connection via	Min. size cable / flex	Cable / flex type	Fuse
Oven Control Circuit	2,5 mm <sup>2</sup>	PVC / PVC twin and earth	15 A min. 20 A max.



## Securing the appliance to the cabinet

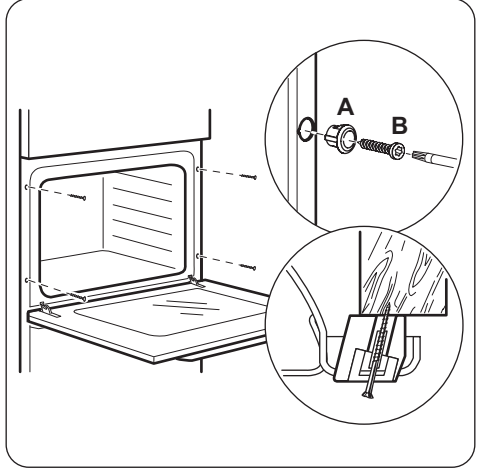

## Electrical installation

**i** The manufacturer is not responsible if you do not follow the safety precautions from the Safety chapters.

This appliance is supplied without a main plug and a main cable.

Applicable types of cables for Europe:

- Minimum size Cable / flex: 1,5 mm<sup>2</sup>
- Cable / flex type: H07 RN-F, H05 RN-F, H05 RRF, H05 VV-F, H05 V2V2-F (T90), H05 BB-F

# Energy efficiency

## Product Fiche and information according to EU 65-66/2014

Supplier's name	Zanussi
Model identification	ZOB35302XE
Energy Efficiency Index	101.2
Energy efficiency class	A
Energy consumption with a standard load, fan-forced mode	0.85 kWh/cycle
Number of cavities	1
Heat source	Electricity
Volume	68 l
Type of oven	Built-In Oven
Mass	30.6 kg

EN 60350-1 - Household electric cooking appliances - Part 1: Ranges, ovens, steam ovens and grills - Methods for measuring performance.

### Energy saving

The appliance contains features which help you save energy during everyday cooking.

#### ▪ General hints

- Make sure that the oven door is closed properly when the appliance operates and keep it closed as much as possible during the cooking.
- Use metal dishes to improve the energy saving.

- When possible, put the food inside the oven without heating it up.
- When the cooking duration is longer than 30 minutes, reduce the oven temperature to minimum, 3 - 10 minutes before the end of the cooking time, depending on the duration of the cooking. The residual heat inside the oven will continue to cook.
- Use the residual heat to warm up other foods.

- **Cooking with fan** - when possible, use the cooking functions with fan to save energy.
- **Keep food warm** - if you want to use the residual heat to keep the meal warm, choose the lowest possible temperature setting.

## ENVIRONMENT CONCERNS

Recycle the materials with the symbol . Put the packaging in applicable containers to recycle it. Help protect the environment and human health and to recycle waste of electrical and electronic appliances. Do not dispose

appliances marked with the symbol  with the household waste. Return the product to your local recycling facility or contact your municipal office.



[www.zanussi.com/shop](http://www.zanussi.com/shop)



867318790-B-212015