

# 3m x 3m Frame TBC

Quote reference:

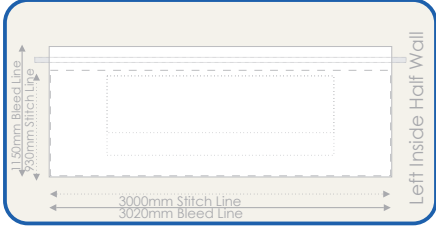

Left Inside Half Wall

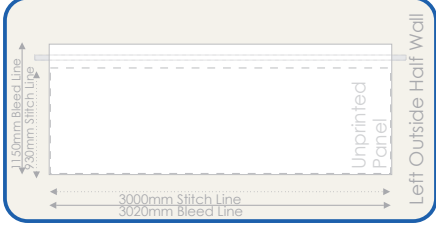

Left Outside Half Wall  
Unprinted Panel

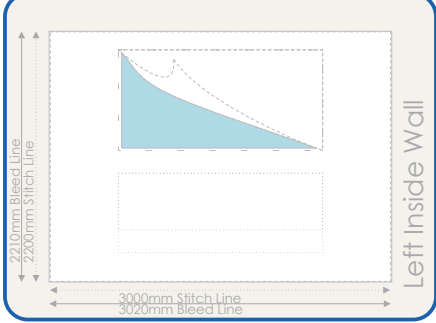

Left Inside Wall

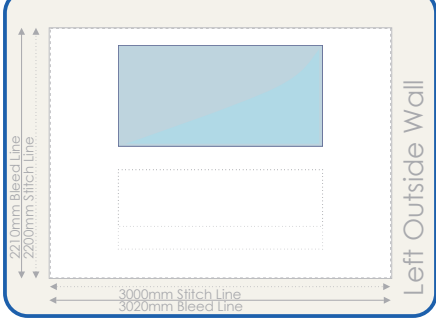

Left Outside Wall

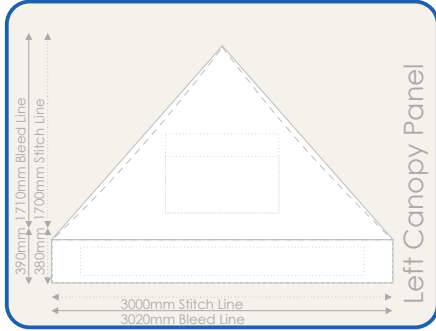

Left Canopy Panel

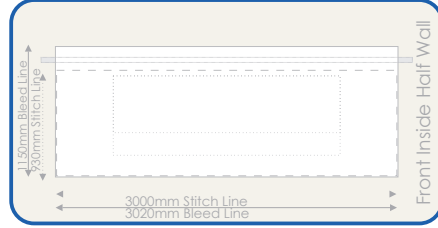

Front Inside Half Wall

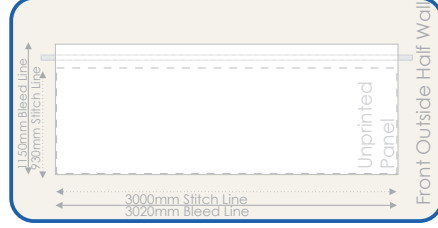

Front Outside Half Wall  
Unprinted Panel

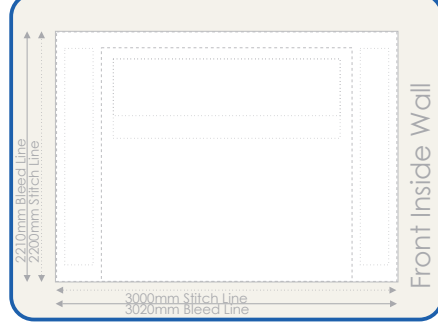

Front Inside Wall



Front Outside Wall

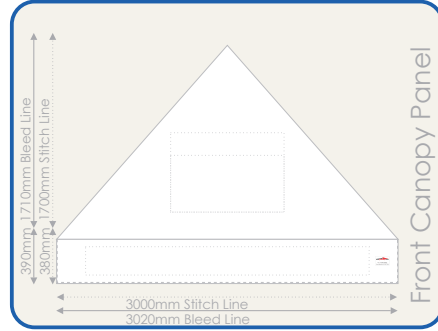

Front Canopy Panel

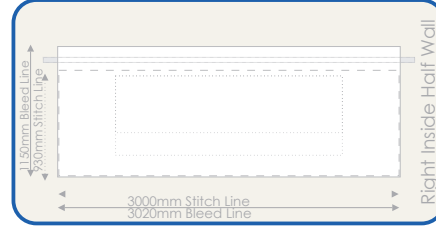

Right Inside Half Wall

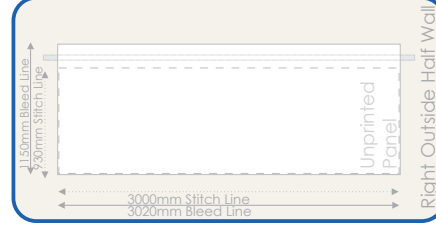

Right Outside Half Wall  
Unprinted Panel

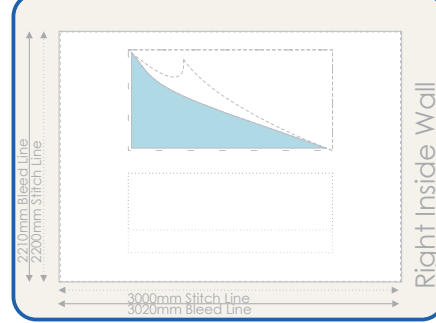

Right Inside Wall

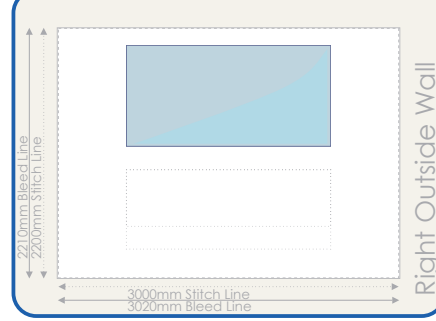

Right Outside Wall

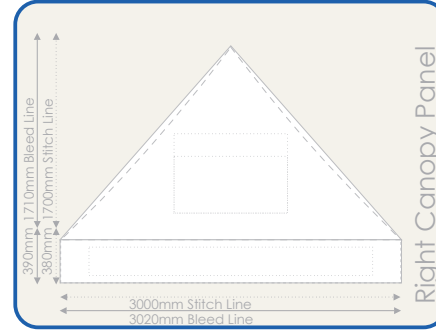

Right Canopy Panel

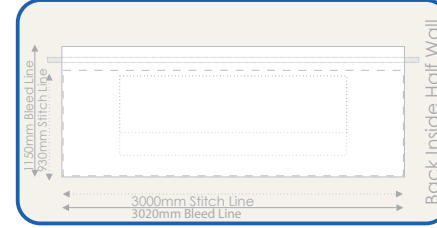

Back Inside Half Wall

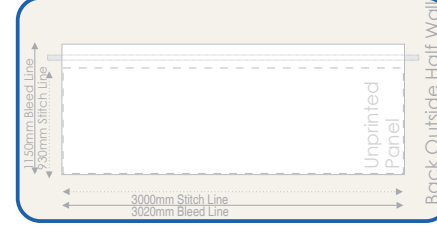

Back Outside Half Wall  
Unprinted Panel

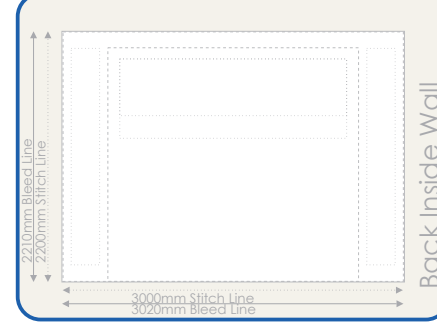

Back Inside Wall

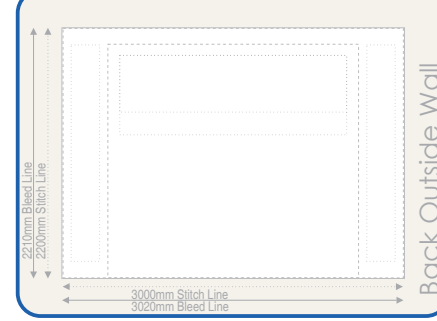

Back Outside Wall

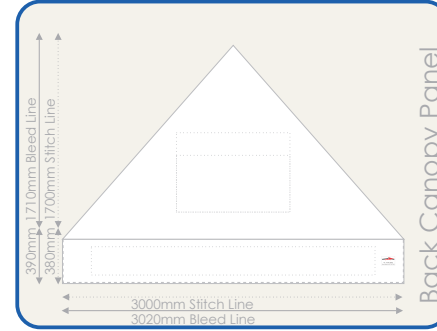

Back Canopy Panel

Artwork Note:

Please check the following details are correct:

- 1. All company details.
- 2. Spelling.
- 3. Phone numbers, Addresses + URL's.
- 4. Positioning of artwork.
- 5. Colours.
- 6. Correct size.

Please fax back to 01295 263750  
or sign, scan, attach & reply to your emailed quote.

Print Name. \_\_\_\_\_

Signature. \_\_\_\_\_

Please Note:

All artwork is printed in CMYK colour space. To ensure your correct artwork please convert all to an equivalent CMYK breakup.  
Please be aware that slight colour variation may occur in the printing process from monitor to output. Rasterised artwork is printed at 300 dpi. We advise full sized artwork supplied at 300 dpi for best quality, we can work to 72dpi at a low quality print.  
Our visuals are copyright protected & are not be forwarded to other companies otherwise an art working fee will be enforced.

Note: "Halfwalls" are folded over a crossbar and stitched onto the inside.  
For front printing the artwork should be up to the designated top of the half wall stitch line. Inside artwork is not available.

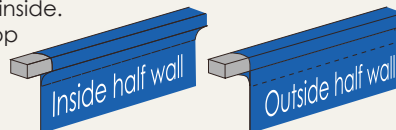

Front

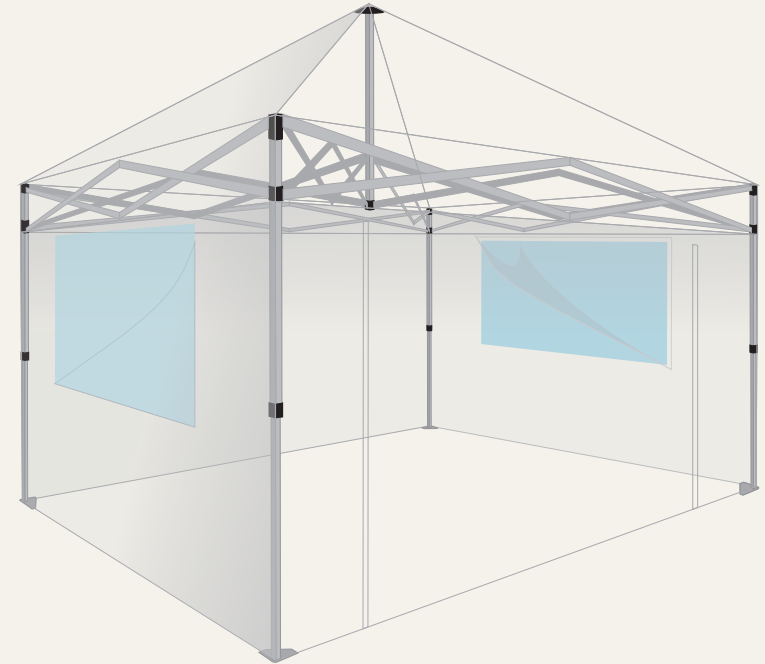

Back

