

# MANUAL *of* GLIDING

**DESIGN & CONSTRUCTION**

**SPECIALLY PREPARED *for* R.A.F & A.T.C**

No. 20



**COMPILED BY  
W·R·SCOTT**

**TWO SHILLINGS**

**BERNARDS (Publishers), LTD, THE GRAMPIANS, WESTERN GATE, LONDON, W. 6**



10 Highfield Road  
Corfe Mullen  
Wimborne  
Dorset BH21 3PE  
Tel. Broadstone 693883

TO MR WALLY KAHN  
from  
Walter Roy Scott  
1902.



**Author, W. R. SCOTT, A.M. Inst. B.E.  
Aeronautical Engineer and Glider Designer.**

## AUTHOR'S PREFACE.

From the day on which lucky chance took me into a cinema where a film on flying fired me with the spirit of emulation, I have kept notes on all my experiences and what I learned from them. In this I realise I am by no means unique, neither is my insatiable craving for any experiences connected with the air, but in a not inconsiderable experience of flying and building motorless aircraft it has always struck me that books on the subject are almost invariably either highly technical and academical in their treatment, or are singularly lacking in the kind of information potential birdmen would like to know.

It was with the object of satisfying the ever-growing band of newcomers to this sport, and also to enable other enthusiasts to start where I left off, that led me to introduce this booklet to the public. Whether this object has been achieved can only be answered by my readers, if any, and the audit department of my publisher, who, incidentally, coerced me into including the following autobiographical summary.

At the age of thirteen, and by using a collection of scraps and oddments, I constructed a glider of the parasol or hanging type on similar lines to the early models of Lilienthal, but with modifications which to my youthful mind would electrify the countryside over which I should eventually hover and swoop. Many months went by to the accompaniment of derisive family comments and remarks from friends who obviously questioned my mental stability. However, whilst this latter fear may still for all I know be well founded, it was with this craft that I first became airborne. It was also perhaps the first time that I prayed. Four feet up, if for only a distance of twenty to thirty feet, to a lad drunk with achievement, can be devastating in its realisation, and the intoxication of this flight has remained with me ever since. The machine itself, by present-day standards, should never have flown, "stress" being a word with which I was only dimly familiar. The entire plane was covered with heavy terabine coated brown paper. The inevitable pile-up occurred with, fortunately, no ill-effects, and I immediately set to work on a more ambitious model. About this time too, I was fortunate enough to come across a number of illustrations showing the trend of glider design in Germany, a country which, as everybody now knows, was busy developing this form of craft with concentrated objectiveness with the financial backing of the German government. They were in fact demonstrating certain of these models in England, although I was never present at any of these

demonstrations. I did, however, make good use of my discovery and made several successive machines with progressive results.

The last of these came to the notice of the late Duke of Grafton, who subsequently proved himself my very good friend. It was he who encouraged me to tackle the job from a more serious and scientific angle, and placed at my disposal Euston Hall Park and the very useful garage facilities adjacent to it. He, it appeared, had become enamoured of the sport at about the same stage in his life as myself, and shortly after our meeting became a founder member of the Cambridge University Gliding Club. From this time on Euston Park saw much flying activity, and with its owner's prompting and from studying the finer points of more advanced German types, I built my most successful machine to date. It was a two-seater tandem with a span of approximately 44 feet, a cord of 6 feet, and was fitted with dual control. The machine took 18 months of hard work to complete, but proved well worth the effort expended. It was very stable and made a large number of flights until an ex R.A.F. Test Pilot, to whom I was introduced, requested the opportunity of trying something with no power attachment. Simultaneous with this introduction I was approached through a friend of mine by Lord St. Davids, of Landwade, Newmarket, who during that summer had shown a keen interest in the glider's capabilities, with a tempting purchase offer. The Test Pilot, however, wrote off the model by flying into a clump of trees, and put paid to the first temptation to commercialize my hobby. Notwithstanding this, Lord St. Davids persuaded me to build him a Glider of a rather more modern type, designed without wires and fitted with strutted wings. The machine made a number of flights around 30/40 feet on his estate outside Newmarket, but did not unfortunately come up to the promise of the previous model. This venture provided me with the wherewithal to apply the knowledge of aero-dynamics which was by now beginning to make itself evident, and incidentally, with each model completed, I was acquiring the knowledge required for quicker methods of construction. It should be noted that up to this time I was still serving my engineering apprenticeship, but when I was half-way through the construction of the next machine on my plate, I completed this apprenticeship, and was offered a position with a firm of light aeroplane constructors in Dunstable. With the object of concentrating on what by now had become an obsession, I accepted the offer with alacrity. The semi-finished model on which I had been engaged was purchased by a North

Walsham club, and was never completed. The opportunities for study now became extremely frequent, as Dunstable, being the hub of the London Gliding Club, saw the advent of almost all the advanced ideas incorporated in gliders and sailplanes in the country. The company for whom I was working did a considerable number of repairs and reconditioning for this club, and whilst I was with them reconstructed and built replicas of many old type machines, including light power craft. Among the replicas were those which my readers possibly saw in a film produced by Alexander Korda called "Conquest of the Air." Some remarkable efforts of earlier times were produced, including a model with flapping wings. A replica of the first Bleriot to fly the channel was built for Mr. R. G. J. Nash, of the Brooklands Aero Club. We also designed and built the first high performance machine for the Cambridge University Club, ordered by the late Duke of Grafton, who subsequently met with a fatal motor racing accident.

The "Flying Flea" now took the stage, and a considerable amount of my time went into the development of an English version, until the Government refused to grant the necessary certificate of air worthiness for any further machines of this type.

August of 1937 saw the next step in what by now I had determined to make my career, the firm by whom I was employed closing down and circumstance dictating a bold course, I went into partnership with my former employer, later forming the company known as the Scott Light Aircraft, Ltd., with Lord St. Davids as Chairman of the Board of Directors. Numerous machines were made and the Company enjoyed some reputation for the soundness and all-round performance of its products.

About this time I designed and built a sailplane of the high performance class for the late Amy Johnson, who, in partnership with Captain Rattray, established the reputation of the Company for machines of this type. Captain Rattray was later responsible for the formation of the Oxford University Gliding Club which we largely equipped with training models. Mr. Alan Colman of condiment fame placed orders for similar machines for the Norwich Gliding Club, and altogether 1937 could be accounted a successful first year, and in 1938 a permanent and enthusiastic member of the London Gliding Club was so rash as to advance by way of inducement a sum sufficient to design the type of really high performance English sailplane which had been my ultimate ambition to produce, as to date to the best of my

knowledge nothing all-British in design had appeared in this country. In production, although a number of one-offs of various designs had been produced. The machine fulfilled and, in fact, exceeded all my expectations, when Mr. R. P. Cooper took it with him on a business trip to Buenos Aires, where it later broke records in that part of the world, previously held by German machines. My wife suggested the name of VIKING, and as VIKING I, it was the forerunner to a series of similar single-seater high performance sailplanes, all of which could claim that certain something which the others hadn't got. The machine had a number of outstanding features for a production job, the foremost of which was the method by which the wings were attached to the fuselage; this was by means of three pins. All the mechanism controls automatically interlocked, rendering the operation of attaching and detaching simple and quick, as no external adjustments were necessary. A special mechanism was also installed enabling the pilot to use the ailerons to change that section of the wing in which they operated, and at the same time permitting the movement necessary to their normal functions. This later became a feature of other makes of sailplanes, although the VIKING I was the first machine to incorporate this type of mechanism in the design. A two-seater was my next, and unfortunately the last venture before the outbreak of war, and quite naturally being a two-seater was known as VIKING II. It bore all the characteristics of the single seater and was, according to Mr. Philip Wills, the British Glider record holder, with whom I flew on a series of test flights, a delightful machine to handle. Further knowledge of its flying capabilities were from then on demanded us, and since the date on which hostilities began I have, like so many other enthusiasts, called a halt to activities connected with peaceful pleasure. I have not, however, severed all connection with the flying world, and have the satisfaction of knowing that many of the bits and pieces for which I have been responsible as Managing Director of an Aircraft component factory, are doing their stuff amongst the thermals, and speeding the day when we shall once more be able to dice at Dunstable.

## THE TERMS "SAILPLANE" AND "GLIDER" DEFINED.

There appears to be a singular lack of agreement on the essential difference between these two types, and below is given a ruling which the reader may take as authentic.

**SAILPLANE:** The term "Sailplane" may be applied to machines capable of sustaining an average sinking speed of or below 2.7 feet per second. This compares with the sinking speed of an efficient power plane with the motor switched off, of approximately 19 feet per second. It will, therefore, be seen that with a sinking speed as low as that mentioned, the Sailplane can easily stay aloft and actually gain height while gliding through, or circling in, patches of air, having a vertical upward speed of 2.7 feet per second, or over. The Sailplane may be regarded as an advanced form of Glider, to which the enthusiast naturally graduates when he has reached a proper degree of flying efficiency.

**GLIDER:** The term "Glider" may be applied (see diagram 1) to a machine, which after being launched into the air, can only make a downward descent at approximately one in twelve to one in sixteen measured in still air (see diagram 2). It is, therefore, a rather more advanced type of trainer craft, having deliberately less efficient characteristics plus external bracing wires, in themselves detrimental to efficient flight.

It is more substantially built than the "Sailplane," enabling it to stand up to the rougher handling received from less advanced pilots. It is not intended, however, that the reader should form the wrong impression of this type. It should be pointed out that very interesting flights can be made with a Glider and considerable heights attained under favourable conditions.

The term "Glider" again applies to the simplest kind of machine capable of leaving the ground and maintaining any height whatever. In other words, the machine on which the potential pilot first receives his initiation into flying.

The commonest design is undoubtedly the "Dagling," nicknamed also "Ground Hopper" or "Flying Gatepost." It has a span of approximately 30 feet, with a parallel cord giving no taper in width or thickness to the wing. It thereby lends itself to the cheapest and quickest method of construction, all the ribs being of the same section, and rendering repair work and replacement quite easy to the semi-skilled craftsman. The fuselage of this type of craft is nothing more than open framework with the pilot's seat and controls situated in the front. The seat is generally a simple one in the shape of a bucket to prevent the pilot, especially during the early stages of training, from sliding off when bumping over the ground and leaving it for only a few feet at a time. It is from this characteristic form of flight that the nickname "Ground Hopper" originates.

The wing meets the open frame fuselage just above and behind the pilot's head, and is braced rigid to the fuselage by means of a flexible steel cable, capable of taking strains up to approximately 20 cwt. Piano wire was formerly used for this purpose, but is no longer favoured owing to its natural tendency to fracture at the looped ends where it picks up the various fittings. This tendency can, of course, be very dangerous in the case of those wires which take the strain during the period in which the machine is airborne, and

# PRIMARY GLIDER.

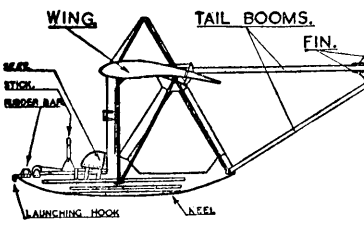
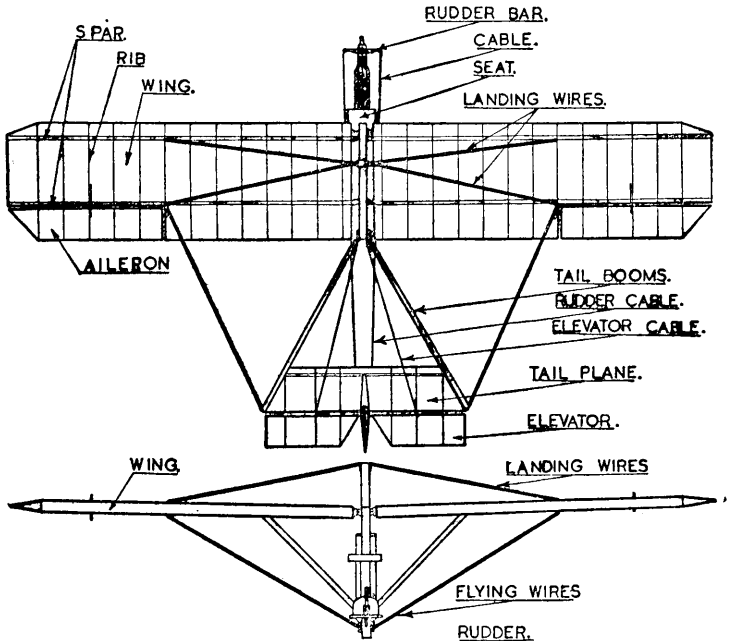

OPEN PRIMARY.

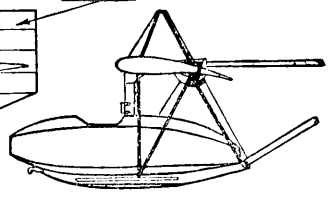

NACELLE PRIMARY.

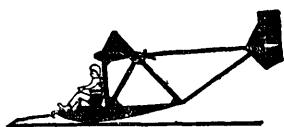

BEFOR TAKING OFF

PRIMARY



TAKING OFF

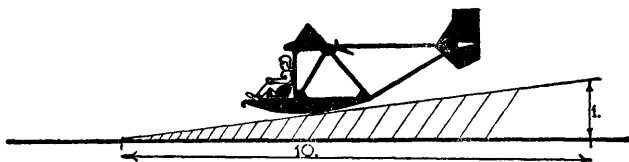

PRIMARY GLIDING IN STILL AIR. GLIDING ANGLE APPROX: 1 IN 10.

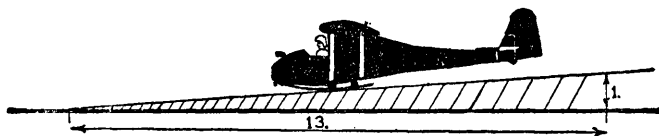

SECONDARY GLIDING IN STILL AIR. GLIDING ANGLE APPROX: 1 IN 13.

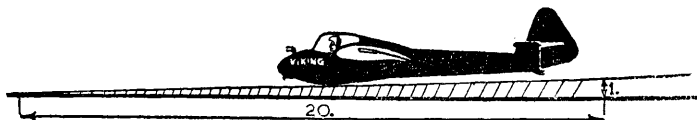

SAILPLANE GLIDING IN STILL AIR. GLIDING ANGLE APPROX: 1 IN 20.

No.2.

whilst it is still the practice of some clubs to use piano wire for the top cables or landing wires where only the downward thrust of the wings when landing is involved, their general use has for some time past been discontinued. These wires make contact with the highest point on the fuselage, generally in the form of what is known as a "pylon," and are frequently fitted with a weak link which breaks under the strain of a heavy landing. This deliberate weakness and the consequent snapping allows the wing to touch down gently under its own displacement of air, the result being very minor damage, and frequently none at all. Any design is, of course, no matter how excellent, a question of compromise involving advantages and disadvantages, and this method of construction is no exception to the rule, having the disadvantage of requiring considerable skill on the part of the rigger to make the machine fly true with hands off the controls.

Referring back to the Pylon, it should be noted that this protruberance serves a double purpose, as should the machine land upside down, or be blown completely over by a sudden gust of wind, it prevents the machine from collapsing on and around the pilot's head.

The pilot is secured in his seat by a harness consisting of four straps, one over each shoulder, and one round each side of his waist, meeting in the centre of his chest and secured by a clip on a short length of cord. This arrangement is universally approved, and has the advantage of freeing a pilot of his harness immediately by one snatch on the cord. Adjustment consists of a row of large eyelets in the end of each strap (see diagram 3).

The question of adjustment is of primary importance, as it is essential both from a safety point of view and the feeling of confidence engendered in the pilot, that this harness be fairly tight. Within reason, the more tightly this harness fits, the better sense of security enjoyed by the pilot, who thereby feels himself an integral part of the machine.

The Tailplane elevator, fin and rudder are connected with the fuselage framework of the training machine by four steel tubes braced rigid with wires which are taken out to a point approximately half-way along the wing, and picking up the same fittings on the rear spar as the landing wires. Each individual tube is a separate unit, which in the event of a minor crash can easily be replaced should they become bent or dented, and so keeping replacement costs at an absolute minimum. This is no small item with the average Gliding Club. It is this very point which has popularised this type of machine as opposed to the higher performance models with circular or oval fuselage for training beginners.

### **NACELLE DAGLING.**

The Nacelle Dagling is a term which is self-explanatory, the machine being in every way identical to the open Dagling with the addition of a Nacelle or blister (see diagram 1) in which the pilot sits. This Nacelle is of very light construction as it is not called upon to take any strain at all. Its sole purpose is to fair in the pilot and give the machine a better gliding angle. Many clubs favour the use of the Nacelle Dagling for training for their pupils from the start, especially those clubs who use the winch method of launching.

# SAFETY HARNESS.

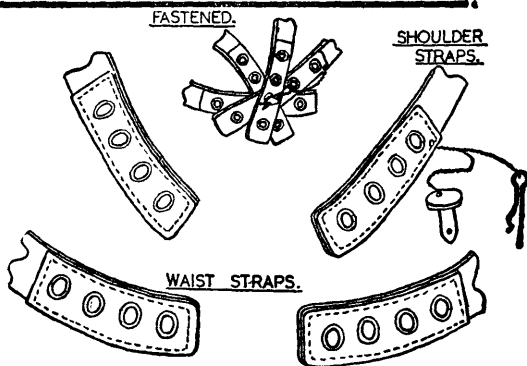
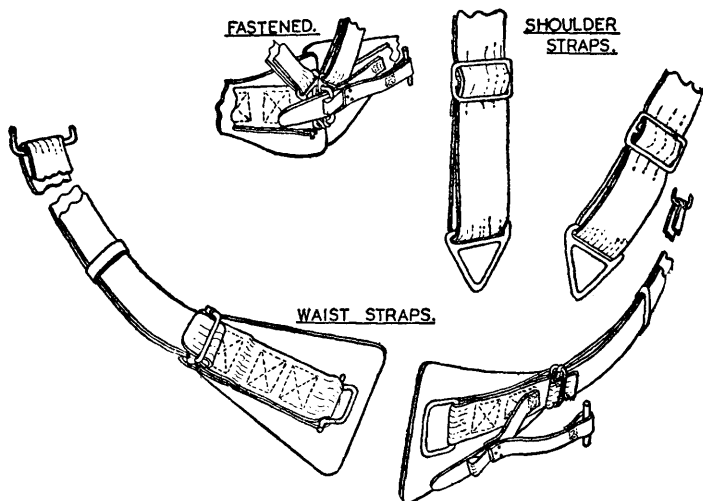

No. 3.

# INTERMEDIATE GLIDER.

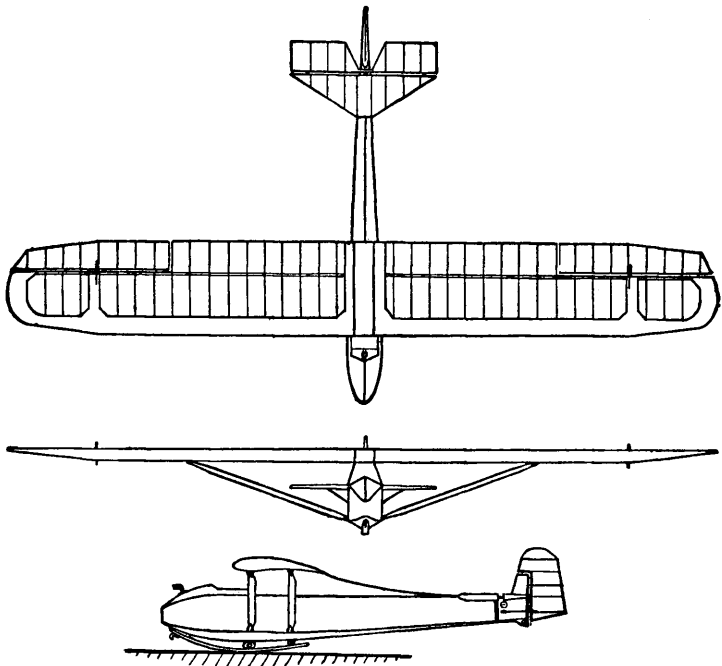

SPAN, 39 FT. 6 IN.      LENGTH, 21 FT.      AREA, 200 SQ. FT.  
ASPECT RATIO,  $7\frac{3}{4}$ .      AEROFOIL SECTION, GOTTINGEN 532.  
WEIGHT, EMPTY, 189 LB.      WEIGHT PER SQ. FT. WITH 160 LB. PILOT,  $1\frac{3}{4}$  LB.  
BEST GLIDING ANGLE,  $1/13$  AT A FLYING SPEED OF 26 M.P.H.

No.16.

## THE INTERMEDIATE GLIDER.

(Sketch No. 16).

The Dunstable Tottenhoe and Cadet are better known makes of machines of this class, and they resemble the Dagling in that they have a parallel cord with little change in the thickness of the wing. They are of the high wing type, the wings being braced to the fuselage with two struts on either side, these taking both the flying and landing loads and so dispensing with all external bracing wires, except for two light gauge wires between the struts. One of these runs up diagonally from the bottom end of the front strut to the top end of the rear strut, and vice versa. The fuselage is hexagonal in shape and constructed of plywood. The top of the fuselage behind the wing is in some cases covered with fabric for lightness. The tailplane is attached to the top rear end of the fuselage and is fitted with a strut on either side. The Intermediate Glider has a performance considerably better than that of the first stage glider, and in the hands of a reasonably skilled pilot can be thermal soared to great heights under favourable conditions. The attainment of such heights with this machine, however, is not to be recommended as the safety factor is not sufficiently high to cope with the conditions likely to be encountered when approaching the base of very large cumulus clouds. It is certainly unsuitable for soaring in the neighbourhood of storms where up currents of air can be of sufficient severity to break the strongest of machines, even though specially designed for such conditions.

## HIGH PERFORMANCE SAILPLANE

(see Diagram 5).

The Sailplane, on the other hand, is a machine with considerably more wing span than either the trainer type or the intermediate glider, the wings tapering towards the tips. Great care is taken to keep the lines of such a machine clean, and the pilot sits in a cockpit which for purposes of efficient streamlining is generally totally enclosed, although in some cases they have detachable cockpit covers which allow the pilot's face to be exposed to the air, a practice favoured in the early stages of high performance flying, especially aerobatic training. It might be assumed that a sailplane designed for high performance in the nature of long distance flights and the attainment of great height above and among the clouds, obtains such performance from a comparatively flimsy construction. This is not the case, as whilst being necessarily designed with the idea of eliminating the maximum excess weight, the consequent better performance brings in its train considerably higher stressing in actual flight. It should, therefore, be understood that whereas it is not a machine which lends itself to the knock-about ground hopping of the elementary trainer, it is nevertheless constructed far more scientifically for the loads it must carry during flight. It will be readily realised that only the experienced glider pilot will fly this type of craft; that being the case, the weight which normally accompanies the landing gear of the trainer is eliminated to the greatest possible extent, as it contributes nothing whatever to the strength or flying qualities of the plane when once in the air. The greatest care is taken to give aero-dynamic form to each component, and the fuselage is given only that section which is sufficient to house the pilot in a sitting posture. Even the angle of this posture is studied and in many types the pilot will be seen to be leaning slightly backwards, enabling the head-on area to be kept to a

# SAIL PLANE. THE "VIKING I."

DESIGNED BY THE AUTHOR.

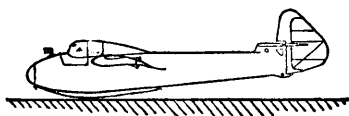
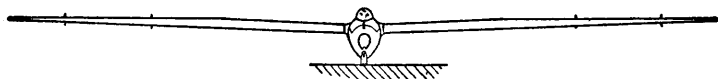
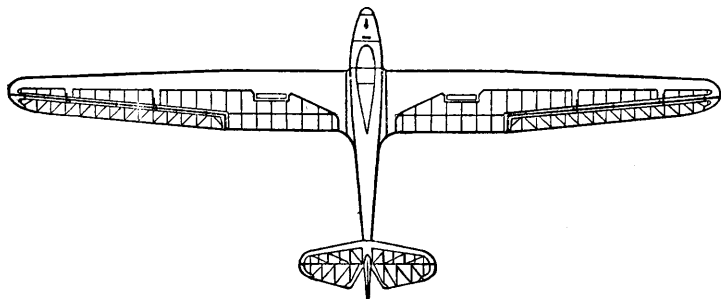

<u>SPAN</u> . . . . . 51 FEET.	<u>WING AREA</u> . . . . . 171 SQ. FEET.
<u>ASPECTO-RATIO</u> . . . . . 15.4.	<u>WEIGHT EMPTY</u> . . . . . 370 LBS.
<u>WING LOADING</u> 3.15 LBS./SQ. FT.	<u>SINK</u> . . . . . 2.5 FEET PER SEC.
<u>GLIDING ANGLE</u> . . . 20 TO 1.	<u>SAFETY FACTOR</u> 10.

No. 5.

minimum. The performance of the machine depends very much on the care taken to keep its total displacement down, combined with the perfect stream lining and a fairing in all wing roots and that part of the fuselage to which the tailplane is attached. Here again a compromise has to be reached as it is at this point that, on account of the greater size of the high performance sailplane, mechanism must be incorporated to enable the wings and tailplane to be detached for purposes of transport. The cockpit cover in the case of a totally enclosed machine presents similar problems to its designer, as although efficient stream-lining is the goal, the importance of the pilot's visibility cannot be overlooked. A flat wind shield would naturally be more suitable for this purpose, whereas good stream-lining demands the use of material curved in two directions. It may interest the reader on the next occasion on which he has the opportunity of observing one of our large bombers at close quarters, to note the flat window let into the curve of the nose piece facing downwards. This is inserted for the sole purpose of preventing distortion of the bomb aimer's vision.

### SAILPLANES.

There are many popular designs in this class, the performance of which varies considerably. Perhaps the most popular is the Grunau (see diagram 4). This machine originated in Germany. It has a high wing fitted with struts, the fuselage being hexagonal in section. The tailplane is fastened directly to the top longerons of the fuselage by two vertical bolts over which the tailplane is passed and secured by two nuts on the top surface. A pair of struts is added to still further brace the tailplane rigid with the fuselage. The whole machine is of robust construction and straightforward in design. Several complete machines were imported from Germany by clubs and private owners, in fact Grunaus were sent to almost every part of the world where Gliding Clubs existed. A number of English clubs and individual members built machines of this design under licence from Germany, from whom were obtained sets of working drawings and the necessary metal fittings ready made. The practice of obtaining such fittings was followed owing to the fabricating of such parts being beyond the skill of the average amateur glider builder, and was to be recommended, as in many cases these fittings required oxy-acetelene welding, which should not be undertaken by anybody below the standard imposed on an Air Ministry approved welder. The reader should note for future reference that whilst welding may frequently look neat and strong from the exterior, the penetration may be poor and result in a weak joint capable of parting under the strain of flying conditions. The Grunau not only appeared in this country in the form of its original design but left its mark throughout the Gliding world in this class, for on close inspection of many of the earlier types of British sailplanes, it is quite evident to those familiar with the Grunau that it was copied extensively.

Two of the most popular machines developed from it were the "Cambridge" and the "Gull." The first "Cambridge" was designed and built to the order of the late Duke of Grafton, shortly after the Cambridge University Gliding Club was formed. The second was built for Captain Rattray and Mr. E. J. Furlong who, in partnership and over a period of two or three years, made a considerable number of cross-country flights with it.

Another British high performance sailplane was the "Hjordis," designed by Squadron Leader D. M. Buxton, although only one machine of the type was built. The "Hjordis" had a cigar-shaped fuselage circular in section with a fully cantilever wing tapering from the centre to the tip and mounted on a rather high neck. The wing had no dihedral, and due to the fact that the lower surface was on a flat plane it had all the appearance of a caedral angle. The rudder was mounted on a short fin with very little surface area in front of the hinge line. The empinage was completed with a pendulum elevator which was favoured at about this time. The span was 61 feet, the wing area 123 square feet, and the weight (less pilot) 350-lbs. The wing section at the root was Göttingen 652, changing over to R.A.F. 32 at the tip.

It was not until the year 1938 that high performance sailplane designing and building showed any real progress in England, but synonymous with several types which showed an improved trend, the author takes some pride in the fact that this year saw the appearance of the Viking I. Several of these were manufactured by the Scott Light Aircraft Ltd., of Dunstable. The Viking I was a shoulder wing machine with a normal pear-shaped fuselage, the cantilever wings making a butt joint to the very short wing stubs on the fuselage, and did not require any detachable fairings at this joint. They were attached by three pins, two of which were tapered. These taper pins were located at the top and bottom of the main spar, while the third which was a parallel pin was inserted from the top on the rear of the wing. Both aileron and spoiler controls interlocked without the addition of pins when assembling. The tailplane was mounted on the top of a very short fin, and was secured by three bolts which were inserted from the top surface of the tailplane, screwing into nuts which were fastened to fittings inside the fuselage. The boltheads were covered by a small sliding fairing after assembly. The elevator control also interlocked on assembly, and consequently required no pins or further adjustment prior to flying. Both the aileron and elevator hinge pins were of the knuckle type. It was unnecessary to remove the rudder when putting the fuselage into a trailer, as the tailplane could be fixed with the rudder previously in position. A big point about this machine was that owing to the fact that detachable fairings were avoided and all controls interlocked, it was possible to rig this machine ready for flight in less than five minutes, and after flight to de-rig it in a similarly short space of time. The aileron mechanism was specially designed to enable a pilot whilst in flight to raise or lower both ailerons at the same time, there being two fixed positions upward and downward. At the same time the ailerons could be operated normally, the adjustment being made by a small lever on the floor of the cockpit with a square-toothed positive ratchet. The rudder pedals were easily adjustable to any given pilot. An entirely enclosed transparent cockpit cover housed the pilot, double curvature was avoided to give undistorted vision. The machine was suitably stressed for aerobatics and storm flying, and proved in test flights to be very stable. In fact, considerable difficulty was experienced in making a voluntary spin, the machine coming out rapidly by centralising the controls, or letting go of them. The main features of the machine were as follows:—

# "GRUNAU." GERMAN DESIGN.

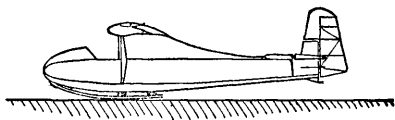
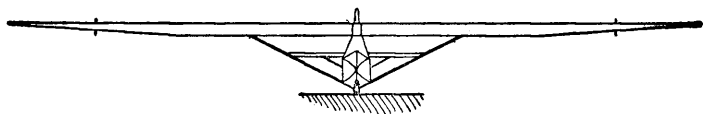
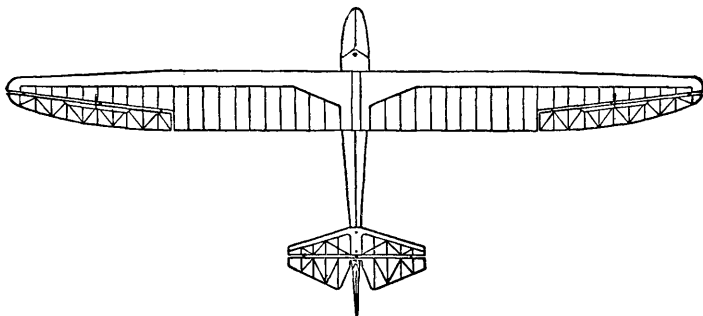

SPAN: 13.5 m. (44.3 feet)

AREA: 14.2 sq. m. (153 sq feet)

WEIGHT EMPTY: 112 kg. (246 lbs.)

ASPECT RATIO: 12.8

SAFETY FACTOR: 8.

**No.4**

Span—51 feet.

Cord at root—4 feet.

Wing loading—3.15-lbs. to the sq. foot.

Overall length—19ft. 10ins.

Pilotless weight—370-lbs.

Aspect ratio—15.4.

Sinking speed— $2\frac{1}{2}$  feet foot stroke seconds at 33 m.p.h.

Viking I was succeeded by Viking II in 1939. It was based on the Viking I but built to hold two side by side. Apart from this difference and the fact that it was a mid-wing, it was identical to the Viking I. The author designed this as a mid-wing for the purpose of enabling the pilot and passenger to make use of the forward position of the wing stubs on the fuselage for elbow room, and also to keep the head on area to a minimum. A single wheel situated at the rear of a short landing skid was added to ease the take-off. The machine was equipped with dual controls for purposes of tuition. The main features of the machine were as follows:—

Span—61 feet.

Cord at root—5ft. 1in.

Overall length—22ft. 1in.

Aspect ratio—16.3.

Wing loading—3.8-lbs. per sq. foot.

### THE FLIGHT OF THE GLIDER.

The first and most obvious difference between the Glider and the Aeroplane is the lack of engine in the former, and whereas at first sight this would appear to be an insuperable barrier to flight of any sort, and in addition a feature which stamps it as of inferior breed to the Aeroplane, this is most definitely not the case. In flight, the Glider, as all who are familiar with the sport would affirm, is quite unique. The sense of personal power over the elements, the pitting of one's skill with the ever varying currents and conditions, induces a sensation of almost majestic triumph. The Aeroplane, on the other hand, relies on a power agent by which it is pulled into the air regardless of air currents or climatic conditions generally. This power also enables the Aeroplane to carry out almost any form of manœuvre without losing height. The pilot is, therefore, robbed of the feeling of personal achievement which is the prerogative of the Glider man. In fact, whilst the comparative mechanics of flight in the two types have certain points in common, the effect of this on the pilots of the respective craft bears no comparison whatever. We will, however, analyse the theory of flight as it concerns the machine itself.

The Glider relies entirely on gravity for its forward motion; this being a natural downward force, it necessarily follows that before this can be made use of, a reasonable height must be given to the machine. Forward motion is, therefore, applied by mechanical means in the first place, viz., catapult, winch, towing craft, etc. Forward motion being given, it will be found that the Glider has the same natural tendency to rise as the power craft and for the same fundamental reasons. Sketch No. 2 shows a Glider in a stationary position. From it will be noted the angle of the under-surface of the wing in relation to that of the ground. The controls being in a neutral position, and the machine correctly balanced with the particular weight of the pilot about to fly and sufficient forward speed given, the air pressure

NORMAL AIR FLOW  
OVER WING.



WING SECTION AT TIP.



AIR FLOW OVER  
FLAT SURFACE

AIR PRESSURE DISTRIBUTION  
ON WING

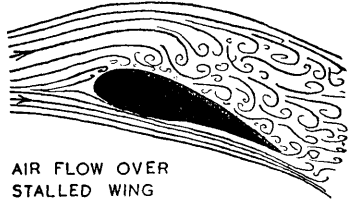
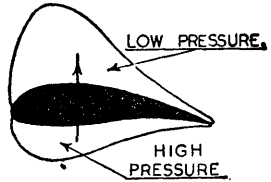

AIR FLOW OVER  
STALLED WING

No.6.

C.P. (CENTRE OF PRESSURE)

C.G. (CENTRE OF GRAVITY)

DOWN LOAD ON TAIL PLANE  
WHICH COUNTERACTS THE  
TENDENCY TO DIVE

ANGLE OF INCIDENCE.

DRAG.

C.P.

C.G.

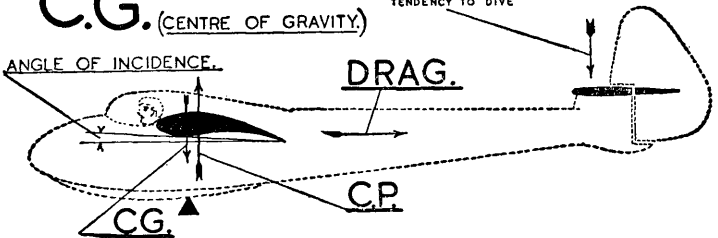

C.P. MOVES FORWARD WHEN PULLING OUT OF A DIVE. (C.P.F.)

C.P. MOVES BACK IN A FAST GLIDE NEARING TRAILING EDGE IN A TERMINAL DIVE. (C.P.B.)

C.G. IS THE POINT AT WHICH THE MACHINE COMPLETE WITH PILOT WILL

BALANCE IN FLYING POSITION.

No.7.

on the underside of the tailplane will lift it until it offers no angle to the direction of motion. At the same time, the tail being lifted to this extent, the wing is now set at a slightly greater angle and will, therefore offer resistance to the air, due to the angle of incidence and the shape of section (for example, see sketch No. 6). This sketch illustrates the manner in which air flow creates a partial vacuum above the wing and approximately two-thirds of the lift is derived from this source. The resistance of the under-surface of the wing to the air provides the other one-third. The rising, therefore, continues whilst the machine is pulled through the air, and will continue for as long as forward motion is maintained. The height to which the machine is drawn is dependent on the length of the connection between the machine and its towing or launching agent, from which height the machine will descend in a glide according to its own design, characteristics, or conditions prevalent at the time. The centre of gravity of the machine being slightly in front of the centre of pressure of the wing the machine automatically noses down, increasing speed and correspondingly the air flow over and below the wing surface, and so continues to make use of this lifting tendency until the stronger force of gravity brings the machine to earth again.

The shape of the wing section which is a matter of individual design has a distinct bearing among other factors on the angle of glide, and this together with the skill of the pilot who can control by means of upward or downward movements of the elevator the angle of the wing to the air flow, determines the length of time the glider will remain in what is assumed to be still air for the purpose of this explanation. It will be noted in sketch No. 7 that the centre of pressure on the wing is situated at approximately one third of the cord from the leading edge. This centre of pressure also moves backward or forward according to the incidence of the wing in relation to the air flow, although there are wing sections having no movement of the centre of pressure, and, therefore, greater inherent stability due to less counteraction required of the elevator. Unfortunately these sections are seldom good from a lift point of view, and a compromise is generally arrived at.

To return to the glide which follows a launching, this may be assumed with the average Glider to be approximately 33 miles per hour, with a vertical sinking speed of  $2\frac{1}{2}$  feet per second.

To gain height with a Glider it is necessary to fly above the ridge of a hill against which wind is blowing and causing an upward deflection, from which it will be readily appreciated that if a machine with a sinking speed of  $2\frac{1}{2}$  feet per second is flying in air which, by reason of local conditions, is deflected upwards at a speed of three feet per second, the Glider will rise at the rate of half a foot per second. This rise will continue until strata is reached where the upward movement of air is equivalent to that of the sinking speed of the machine, when the force of gravity will once again be enlisted to impel forward motion and a lifting tendency. Incidentally these air currents vary quite considerably over a comparatively small area, and will explain why, on occasions when Gliders and Sailplanes are to be seen soaring above a ridge of hills, they are generally at varying heights. There are again the additional factors of design variations and the skill of the respective pilots in maintaining a forward speed, which extracts the best possible sinking speed performance from their craft. So much for straightforward flight.

We now come to the question of manœuvres and here is a sphere in which the Glider pilot is made conscious of his kinship with his feathered fraternity.

### MANŒUVRES.

The more advanced Glider and the Sailplane are capable of executing any manœuvre of which the power craft is capable, but gravity being the sole agent upon which they can rely for forward motion, they must of necessity be carried out on their downward path (see sketch No. 8).

**DIVING:** This manœuvre is to an extent self-explanatory, and consists of putting the nose down and allowing the Glider to reach the greatest possible speed. This speed can at no time, however, exceed that at which the air resistance of the machine equals its total weight, and it would require a dive of several thousand feet to reach this maximum. The calculated diving speed of high performance Sailplanes with the most efficient form of stream-lining and the best possible aspect ratio, is between 150 and 200 miles per hour. Great care has to be taken to pull out of a dive at such speed.

**LOOPING:** This manœuvre starts with the dive, the object being to attain sufficient speed to carry the plane up and over without, as is the case with the power plane, the assistance of a propeller. On reaching a speed which is sufficient for the purpose, viz., between 60 and 80 miles per hour, the stick is pulled back as with the power plane and the manœuvre executed in the same manner. Having come out of the loop the machine continues on its downward flight.

**STALLING:** This feat is one which can be executed quite as easily unconsciously as consciously, and takes place through flying a machine too slowly, viz., at a speed where air ceases to flow over the lifting surfaces. The particular speed at which it takes place is governed by the characteristics of the design, in particular the wing section, its loading and the aspect ratio. A stall can be voluntarily produced by flying straight and pulling the stick back until all forward movement is lost. When this occurs the controls become temporarily useless. Assuming the machine to be correctly balanced, however, the nose automatically drops when this point is reached, and flying speed is rapidly gained again in the consequent dive. The amount of height lost in a dive after stalling, varies from between 50 and 100 feet according to the type of craft, as a rule due to balancing factors. A stall frequently results in a spin (see sketch No. 6, "Air flow over wing section when stalling").

**SPINNING:** This differs from other manœuvres from the fact that it takes place following a stall in which for a time the controls are useless. The term is self-explanatory, but it should be noted that each particular design of craft has its own characteristic spin, some making a relatively flat spin, while others spin at a more acute angle. The former is the more dangerous, as it is more difficult to correct. This correction consists of pushing the stick forward and applying opposite rudder to the direction of rotation, the machine coming out in a dive. With certain designs it is sufficient to centralise all controls, the machine doing the rest itself. Spinning is responsible for the majority of flying accidents, as it frequently takes place when a machine has no great altitude, and thus offers a pilot insufficient room to effect a

SPINNING.

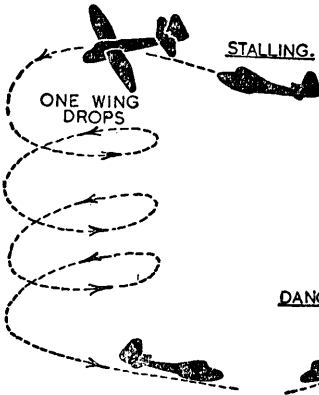

LOOPING.

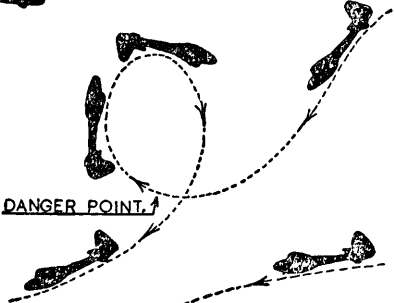

SIDESLIP

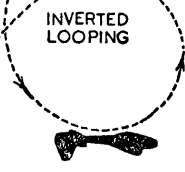
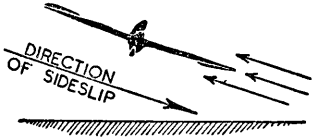

ZOOM.

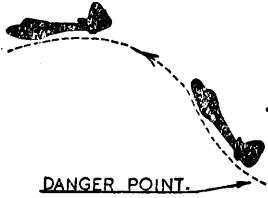

correction. Many a machine has crashed in the early days of a pilot's training before he has had time to realise what is happening, and as his natural tendency is to pull the stick back when seeing the rapid approach of the ground, the only result is an increase in the speed of the spin. In fact, his action would not bring the machine out of its spin if he had several thousand feet in which to operate. However, spinning is very useful to the high performance sailplane pilot under certain conditions, as it enables him to lose height as quickly as possible without gaining forward speed, and at no time puts severe stresses on a machine such as is the case with diving.

**SIDE SLIPPING:** Side Slipping is used as a manoeuvre to lose height without gaining extra forward speed, and is particularly useful to the sailplane pilot in adjusting the height of his approach when coming in to land in a constricted space. It is executed by banking the machine over to the side into which he intends to slip, and applying opposite rudder to that which is used in a turn.

**LANDING:** This should probably not be included under the heading "Manœuvres," but is nevertheless quite important in the skill called for with motorless craft. The pilot of a glider or sailplane frequently finds it necessary to land on unfamiliar territory when making cross-country flights, and as he is not able to nose down, and rejecting his first choice of ground, to climb away and select another spot, he must be able to apply his skill to the maximum in order to make an alternative ground. The glider pilot must, therefore, circle round and lose any surplus height at the last minute of his approach, and it is here that the last-mentioned manoeuvre, viz., "Side Slipping" assumes its right importance.

From the foregoing it would appear that with the disadvantage of the long shallow dive which is natural to the glider, and the pilot's inability to select the best ground on which to land, he is at every disadvantage compared with the power craft. On the other side of the picture, however, the size and surface of the field is not nearly so important to the glider pilot as the machine does not slide far on landing, and in addition has a much lower landing speed. This speed is seldom greater than thirty miles an hour. There is one further point in the glider's favour, a crash landing seldom results in more than slight injury, the landing speed being so low, and the fire danger being completely absent.

## THE CONTROLS EXPLAINED.

The controls of the glider and sailplane are identical to those used in the power aircraft. The rudder used for steering the course is operated by the feet which rest on either a bar pivoting centrally, or pedals.

The elevators which control the fore and aft movement of the machine are operated by means of the joystick which protrudes from the floor between the pilot's knees; it is operated with one hand. When the stick is pushed forward the elevators are turned downwards and the air pressure on the under-surface tends to lift the tail of the machine, so putting it into a dive. By pulling the stick back the elevators are turned upwards and the air pressure pressing the tail down gives the wing a greater angle of incidence to the direction of flight which causes the machine to lift. These effects are, of course, only to be obtained while the machine has forward motion. Should the stick be held back until speed is lost a stall ensues, when air having ceased to flow over or below the surfaces, the controls become temporarily useless. Movement of the stick from left to right, or vice versa, controls the ailerons. On moving the stick to the right the aileron on the right-hand wing rises, and the aileron on the left-hand wing turns downwards.

The air pressure on the under-surface of the aileron which is down tends to lift that wing, while the opposite effect is produced on that wing which has the aileron in an upward position. Naturally a reversal of these movements in the ailerons has an opposite effect.

**SPOILERS:** High performance sailplanes are as a rule fitted with additional controls known as Spoilers or air-brakes (sketch No. 9). These are used for the purpose of limiting the flying speed of the machine, and for decreasing the angle of glide. Coincident with this control may be mentioned the small hand-brake generally found in the cockpit of machines which are fitted with a central landing wheel. This is brought into play to prevent the machine running too far on landing.

## SPOILERS OR AIR BRAKES.

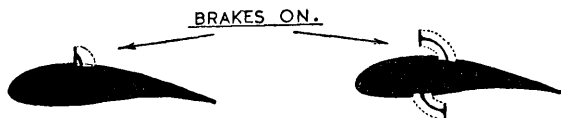

AIR FLOW OVER BRAKES.



## TECHNICAL TERMS.

The following terms are for the guidance of the reader who is desirous of familiarising himself with the complete glider subject, but it should be pointed out that these terms are equally applicable to most motor assisted craft.

**SPAN:** By span is meant the complete measurement of an assembled machine from the tip of one wing to the tip of the other, including the width of the fuselage in the case of a mid-wing machine.

**CORD:** Cord is the width of the wing from the leading edge to the trailing edge, and in the case of wings which are tapered from the root to the tip, is generally referred to as the average cord, being half the width of the wing at the widest end, plus half the width at the narrowest end. This formula is somewhat modified in the case of a wing having irregular shape and taper.

**OVERALL LENGTH:** The length of a Glider is always taken from the nose to the farthest edge of the rudder or elevator, whichever is the greater of the two.

**HEIGHT:** The height is generally that taken from the ground to the top surface of the wing, in the case of a high wing machine, or to the top of the cockpit fairing in a mid-wing machine, the machine being in flying position.

In certain cases, however, there are machines which give a larger measurement with and from the tail skid on the ground to the top of the rudder, and such being the case the greater height is the one to be considered, as the purpose for which height measurements are required is that of accommodation in a trailer or hangar.

**WING SECTION:** This term is one which is self-explanatory, and has been dealt with in a previous chapter. Wing section plays a distinct and important part in the flying qualities of any machine (see sketch No. 6). It should be noted that the section of the average sailplane wing changes considerably from the root to the tip.

**WING SPAR:** The wing spar is the main member or members around which a given wing is built. It is, in fact, the backbone of the wing. In practice it follows various forms, the most popular of which is the box spar, although "I" spars are still used in some designs. The ribs are attached to the spar at right angles. The spar in a single spar wing is generally calculated to take vertical load both up and down, the torsional loads being taken by the leading edge and torsion spar. The design incorporating a single spar wing with this torsion or diagonal spar has in latter years been the accepted practice for high performance machines, although two spars are still used in the construction of wings for the training and intermediate type of glider (sketch No. 10).

**TORSION SPAR:** The torsion spar is sometimes referred to as the diagonal spar, and is used only in the case of the single spar wing. It runs from the main spar at an angle of about 45 degrees to a joint generally in the neighbourhood of a foot from the trailing edge, giving the wing two points of attachment at the root (see sketch No. 11).

# SECTIONS OF SPARS.

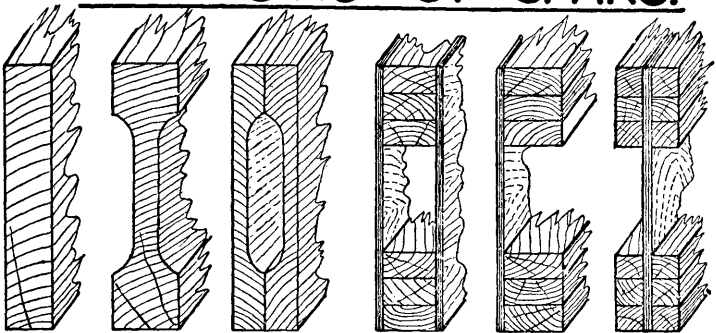

1. SOLID.    2. SPINDED.    3. SPINDED.    4. BUILT UP BOX SPAR.  
5. BUILT UP "U" SPAR.    6. BUILT UP "I" SPAR.

No. 10.

# CANTILEVER WING ROOT.

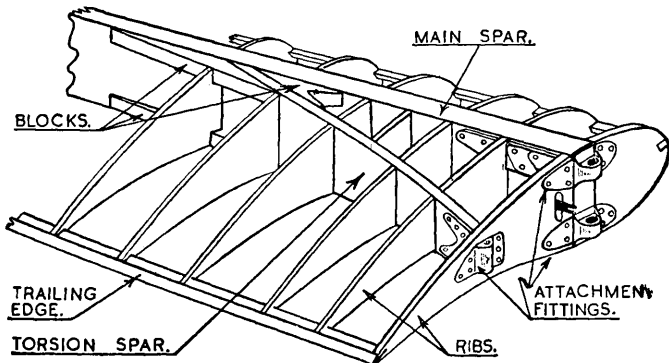

No. 11.

**TORSIONAL LEADING EDGE:** This term is used to describe the plywood covering on a single spar wing which runs from the spar on the lower surface round the nose of the wing to the spar on the upper surface, making the whole nose of the machine into a long D shaped tube, the spar itself being the flat of the D. This plywood covering is of varying thickness, the greater thickness at the root end. It decreases towards the tip where torsional strains diminish. On a normal sailplane with a wing span in the neighbourhood of 50 feet, this ply is approximately  $2\frac{1}{2}$  m/m. thick at the root stepping down to about 1 m/m. thick at the wing tip. The leading edge extends back to the rear point of attachment and picks up along the torsion spar making a triangular box at the root of the wing (see sketch Nos. 11 and 5).

**WING AREA:** Wing area is the sum total of the wing surface given in square feet, although a query frequently arises in the case of the mid-wing and shoulder-wing type as to whether the space taken up by the fuselage should be accounted as wing area or not. To the best of the author's knowledge no ruling has ever been given on this question, although commonsense would, I think, assume that as the area occupied by the fuselage takes no load, it can be discounted as wing area whatever the type of machine.

**ASPECT RATIO:** Aspect ratio is the number of times the cord will divide into the span in the case of the wing which is tapered or elliptical in plan view. The aspect ratio is arrived at by the following formula:—

$$\text{Span}^2 \div \text{main plain area (S}^2/\text{A)}$$

which includes the fuselage in the case of the shoulder wing and mid-wing machines. The aspect ratio has a direct bearing on the flying qualities of the sailplane and those with high performance are generally judged on their aspect ratio.

**WING LOADING:** The wing loading of any flying machine is arrived at by dividing the total weight of the machine including the pilot, by the wing area. The average wing loading of a high performance sailplane is in the neighbourhood of  $3/3\frac{1}{2}$  pounds per square foot, although heavier wing loadings are not necessarily detrimental to a machine's flying qualities. Higher wing loadings, in fact, make for higher flying speeds and is the modern trend.

**GLIDING ANGLE:** Gliding angle is the angle at which a glider descends in still air in relation to a horizontal datum line. It can be arrived at by plotting the vertical sinking speed against the horizontal forward speed (sketch No. 2).

**SINKING SPEED:** Sinking speed is the speed at which a plane approaches the ground measured vertically. With high performance sailplanes this approximates to  $2\frac{1}{2}$  feet per second.

**LIFT:** Lift is the pressure of air against a wing measured as a force working vertically and is made up of approximately one third of its total in air pressure on the under-surface of a wing and two thirds due to low pressure on the upper surface of the wing and half the total taking place in the first one third of the wing from the leading edge back, dying away to zero on the trailing edge (see sketch No. 6). More lift takes place on that portion of the wing nearest the fuselage than takes place out towards the tip. This is due to change of section plus the loss which takes place at the tip.

# AIR FLOW OVER WING.

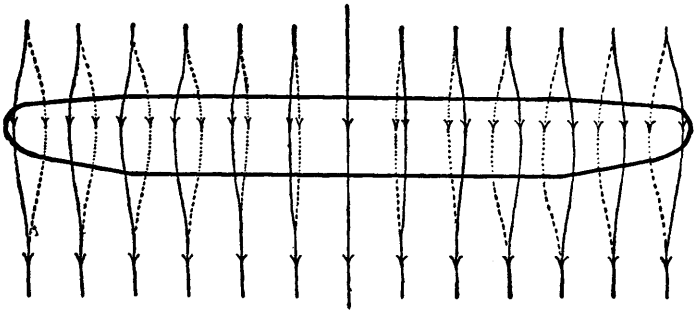

----- AIR FLOW OVER UPPER SURFACE.

————— AIR FLOW OVER LOWER SURFACE.

No.12.

**WING TIP LOSS:** Wing tip loss is loss of lift due to air spilling round the tip, and is caused by the high pressure on the under-surface making contact with the low pressure on the upper surface. This causes a certain amount of change over, and could it be seen in flight it would be noticed that the air flowing over the upper surface of the wing has a slight inward motion, and that on the lower surface an outward motion (see sketch No. 12).

**DRAG:** Drag is a force which is caused by the displacement of a machine passing through air causing friction against the surface of the complete machine. It is the same force which can be experienced by taking a baton and passing it through the air quickly. Definite resistance will be felt, although this will be found considerably less in the case of a round baton. Undue drag is occasioned by badly designed junctions of wing to fuselage, tailplane to fuselage, landing skids, tail skids, and badly faired in joints between wing and aileron, tailplane and elevator, fuselage and rudder, etc.

**HIGH WING:** A high wing machine is one with the wing attached above the fuselage connected with a neck or short struts, and can be either cantilever or strutted.

**SHOULDER WING:** The shoulder wing machine is one where the wings are attached to the fuselage at approximately the height of the pilot's shoulders when sitting (see sketch No. 5).

**MID-WING:** A mid-wing machine is one having the wings attached to the fuselage at a point half-way between the top and bottom of the fuselage.

**LOW WING:** A low wing machine is one having the wing attached to the base of the fuselage and is never used in modern sailplane designs. It has the disadvantage of offering insufficient clearance between the wing and the ground on taking off and landing.

**BRACED WING:** A braced wing machine is one on which the wing is attached to the fuselage with two pins in a horizontal plane forming a hinged joint, the wing being held in position by bracing wires. These bracing wires make contact with the wing approximately two-thirds out from its root and are fastened to a pylon or projection above the wing in the centre and to a low point on the under-surface of the fuselage. This bracing holds the wing rigid to the fuselage. This form of construction is used only on the training type glider as it offers considerable resistance to the passage through the air in flight.

**STRUTTED MACHINE:** A strutted machine is one where the wings make a hinged joint at their attachment to the fuselage, being supported in the horizontal plane by struts. These struts are made either from solid or hollowed-out wood and give a streamline section, steel tubes with a plywood fairing, or built up in the same way as a wing spar with an "I" or box girder centre member, around which a streamline shape is formed in light plywood. In certain cases these struts have been made to conform to a wing section with a view to gaining additional lift from the surface area. Some designers have gone even further and have made these struts to rotate a quarter of a revolution and so offer their widest surface to the air flow to act as an air brake when landing, or to increase the rate of descent.

**CANTILEVER WING:** Cantilever wing is one which is all in one piece being attached above the fuselage, and being stiff enough to take the flying loads without requiring wire bracing or struts. Naturally the majority of sailplane wings due to their large span, are made in two or more sections, having attached points at the root which pick up rigidly with the fuselage by means of two pins on the front spar either vertically or horizontally to the spar, and as a rule, one down vertically or horizontally at the rear end of the diagonal spar; designers have favoured the joining of the two wings together and attaching them as one unit to the fuselage, although this is not being favoured in modern designs owing to the weight of the two wings when attached to one another. The weight is generally in the neighbourhood of 200 to 275-lbs., in the case of a sailplane in anything up to 60 feet in span.

**ANGLE OF INCIDENCE:** This is the angle of the wing as it is attached to the fuselage with the fuselage in flying position. This angle gradually diminishes towards the tip in the case of high performance sailplanes, which gives improved aileron control when a machine is approaching a stall.

**CENTRE OF GRAVITY:** The centre of gravity of a machine is the point at which the machine balances when laid across a roller running at right angles to the skid, and is arrived at with a pilot of average weight in the cockpit. It is most essential that the centre of gravity be just in front of the centre of pressure. If this is not carefully watched, and the centre of gravity is behind the centre of pressure (sketch No. 7), it is extremely difficult to avoid a spin following a stall and extremely difficult to correct when it does occur as one of the essentials to easy correction of a spin is the tendency of the machine to nose forward and gain speed.

**CENTRE OF PRESSURE:** This is the centre of the sum total of the air pressure assumed to be working vertically on the wing, half of which takes place in the first third of the wing. The centre of pressure actually varies with various wing sections and the angle of the wing in relation to the air flow. The centre of pressure forward is generally referred to as C.P.F. and the centre of pressure back C.P.B. It follows that this pressure moves forward when a machine is suddenly pulled out of a steep dive or when launched, whilst it moves back in a fast glide and even reaches the trailing edge in the case of a terminal dive. Due to the variation of the centre of pressure severe twisting movements are imposed upon the wing.

**DOWN WASH:** Down wash is the term descriptive of air leaving the trailing edge owing to its natural deflection in a downward direction (see sketch No. 6).

**EMPINAGE:** Empinage is the term given to the complete tail unit including tailplane elevator, fin, and rudder.

**PENDULUM ELEVATOR:** This term is applied to the tailplane when situated by a pivot at approximately one third of its cord from the leading edge, it operates as an elevator. In fact it is a combined elevator and tailplane. Unfortunately, despite the fact that it is lighter and far more sensitive than the construction in which the elevator is a separate unit from the tailplane it has the disadvantage of rendering a machine unstable when blind flying in cloud cumulus. As a consequence it will not often be found on high performance machines.

**FLAPS:** Flaps have been used on a few sailplanes in the past, although the majority of high performance machines have not been fitted with this accessory. The flap is a piece of wing surface which can be lowered in the same way as an aileron, and is situated between the aileron and the fuselage. In some cases the whole piece of the wing moves down as an aileron does, and in other cases the wing section is split so to speak with only the lower half moving.

**VARIABLE AILERONS** for changing incidents of the wings are the ordinary ailerons fitted with an additional mechanism to enable the pilot during flight to lower or raise both ailerons at once, changing the section of the wing from the portion covered by the aileron, the adjustment being made by a small ratchet lever on the floor of the cockpit. However, this mechanism was only fitted to two high performance machines prior to the outbreak of war. Firstly, the single seater Viking I; and secondly, the side by side two-seater Viking II.

**BOWED AILERONS:** These are ailerons in which the trailing edge takes the form of a bow or ellipse, having a wider cord in the centre of the aileron than at the tip or root end. Its object is to obtain the maximum amount of aileron surface area as far out on the wing as possible, and to make the junction of the aileron to the wing at the inside as small as possible, as considerable turbulence takes place at this junction when full aileron is applied.

**SWEEP BACK:** Sweep back is the term given to the wings of a machine when the tips are set farther back than the root ends, the wing in plan view having an arrow shaped appearance. This design is seldom, if ever, used for really high performance machines as it tends to make the machine far too stable and difficult to manoeuvre. It has, however, in the past been used on many intermediate types of machine.

**WING TIP WASHOUT:** This term is given to a wing which has a smaller angle of incidence at the tip than at the root, thus enabling this part of the wing to maintain its lift after the remainder has begun to stall. It also prevents the inner wing from stalling in tight turns when circling in thermals.

**MASS BALANCE:** This is the lead weight on the end of an arm protruding in front of a control surface, the weight being such that the control surface balances in its neutral position. The need for this balance is to prevent controls fluttering at high speeds, a very serious matter under certain conditions.

## DIHEDRAL.

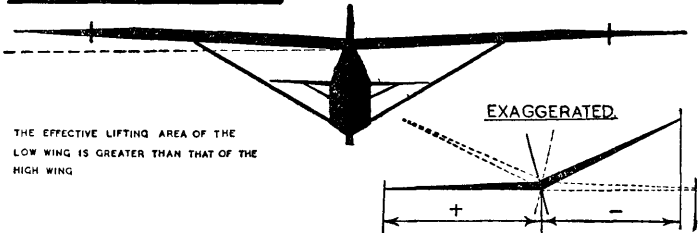

## CAHEDRAL.

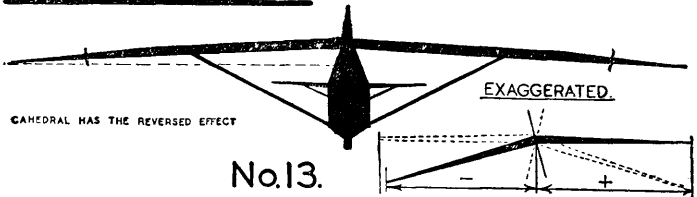

**AERO DYNAMIC BALANCE:** This term is that given to a control surface having part of the surface area in front of the hinge line. This is usually a little less than one third of the total surface area, and is seldom used for other than rudder and pendrum elevators. Aero Dynamic Balance control surfaces, considerably lighten the loads on the controls for the pilot, but are not favoured by the majority of pilots, particularly in the case of the elevator, for the reason that it robs the controls of feel to a certain extent.

**LIFT WIRES:** This term applies to the wires bracing the under-surface of the wing to the fuselage, which are used for primary Gliders. They are described as lift wires, owing to the fact that they only take load whilst the air pressure is lifting the wing.

**LANDING WIRES:** These are the wires that brace from the top of the wing to the centre portion of the fuselage, which mostly takes the form of a protuberance called a pylon. They support the weight of the wing when the machine rests on the ground, and on the impact of landing.

**DRAG WIRES:** Drag wires are those which, from the nose of the machine, lead out and attach to a point approximately two thirds out on the wing span. They are leads to a fitting on the spar, which goes through the wing, picking up both landing and flying wires. Brake wires are also used occasionally on strutted machines, and derive the name "Brake" due to the fact that they take the load set up in the wing resulting from a force endeavouring to fold the wings back, as in the case of a dive.

It will be realised that in a dive, the fuselage is trying to slip forward leaving the wings behind, due to the fact that the fuselage meets with less resistance.

**NACELLE:** This is a small cockpit or fairing which houses the pilot of a Glider. It is just large enough to do this, and no more, and does not run out to the tailplane (see sketch No. 1). In the case of machines incorporating this design, the tailplane is usually picked up by a wooden framework, or steel tubes, the type being used only for training. On the other hand, high performance machines have been built on the Nacelle principle, having a large boom running back to the tailplane. Although this latter arrangement has certain advantages, up to the outbreak of the present war it was not a trend of modern design.

**DIFFERENTIAL AILERONS:** The amount of differential which is employed in the Aileron control system is of considerable importance in high performance sailplanes having a large wing span, due to the fact that when circling it is seldom flying very much above its stalling speed. From this it will be seen that the inside wing tip is itself almost stalled. The differential aileron system has the following effect. The

down moving aileron has a smaller traverse than the up moving aileron, which has a tendency to prevent stalling whilst turning, as having gone into a reasonably steep bank to make a tight turn, little opposite aileron has to be employed to prevent the machine continuing to increase its bank. At such time, the outer aileron would move up on the wing travelling the faster, and the downward moving aileron on the inner wing would move little, if at all, when the joystick was moved only an inch to two inches towards either side. Further movement of the joystick is required to produce more movement on the down moving aileron.

**DIHEDRAL:** This is the angle formed between the under-surface of the wing to a horizontal datum line, the tip end of the wing being the highest above the datum. (See diagram No. 13.)

This has the effect of making the machine stable, and produces a natural tendency to flying level of its own accord. The diagram mentioned above, clearly illustrates by exaggeration, that the wing being lifted by a gust, has a tendency to fall again as it offers less surface area to forces working in the vertical, whilst the wing that has dropped, offers proportionately more. Dihedral is not needed so much on machines with the wing above the fuselage, as in this design the fuselage has a pendulum effect. It is, however, necessary to incorporate dihedral in mid-wing and shoulder-wing machines, and it has the added advantage of greater tip clearance from the ground. The dihedral angle usually varies from zero to approximately 3 degrees.

**CAHEDRAL:** This angle is the opposite of dihedral, the wings having a drooping effect. It is seldom, if ever used, as it gives rise to considerable instability. (See diagram No. 13.)

**QUICK RELEASE:** This is the small mechanism situated in the nose of a machine into which the steel ring on the end of a launching rope or towing cable is inserted. The release is operated by pulling a handle usually on the end of a thin cable in the cockpit by means of which the machine is disconnected from the launching rope.

Considerable care is given both to the design and installation of this mechanism as the danger to which the pilot is subjected should it fail to release the towing cable, is considerable. In the earlier days of gliding instances occurred in which the mechanism failing, the wire was cut from the ground with an axe or similar agent, but this still left the pilot in a precarious position as landing a craft with a great length of cable trailing from the nose complicated matters considerably. In the case of gliders which are towed off by power planes, there is a quick release fitted to the tail end of the towing craft which is operated by the pilot or passenger in this craft. It is used to enable the towing craft to drop the cable over the drome prior to coming in to land, as the alternative is to run a similar risk to the glider pilot with the cable hanging from the nose.

## TERMS USED IN CONSTRUCTION.

Below will be found certain terms which have been included under technical terms but they are added, as in some cases a fuller explanation of their use in construction is given.

**SPARS:** Spars are the main members of wings, ailerons, tailplanes, elevator and rudder, and are constructed in various forms. (See sketch No. 10 Spar Section.)

In the construction of primary type machines, it is usual to use two spars for each wing, but for high performance planes, one spar only is the usual practice. In the latter case it runs along the wing about one-third of the way back from the leading edge, and takes the direct upward loads imposed on the wing, and transmitted via the ribs. Ailerons have only one spar running along the front edge. Tailplanes are almost invariably constructed with two spars, although one spar is used when the pendulum elevator is adopted. In such cases the fixed tailplane is dispensed with. Elevators have one spar running along the front edge only.

**AUXILIARY SPARS:** Auxiliary spars are light members taking little or no load, and are used in the case of single spar wings to stiffen the rib-work, which would otherwise be unsupported between the main spar and trailing edge.

**TORSION SPAR:** This spar is often referred to as the diagonal spar, as it runs at about 45 degrees to the main spar from the root of the wing. (See sketch No. 11). It transmits all torsional loads from the main spar and leading edge to the fuselage. It is not used in two spar wing construction.

**RIBS:** Ribs are the light frame work constructed to conform with the aerofoil section used for wing, tailplanes, elevator and rubber. They are of very light construction, varying from  $\frac{1}{4}$ " x  $\frac{1}{4}$ " to  $\frac{1}{2}$ " x  $\frac{1}{2}$ " for all ribs other than those at the extreme root end. The root end rib is usually rather heavier as it assists in taking the torsional load from the main spar to the rear end of the torsion spar, whilst rudders also have one vertical spar. The spar is necessarily the main component in each of the frames mentioned, and it takes all main air loads, transmitting them to the fuselage. Great care must be paid to these members after even minor crashes.

**BULKHEADS:** These are the frames which form the fuselage, and are built to conform with the fuselage section chosen, hexagonal, or otherwise. (See sketch No. 14.)

The main bulkheads are those which come directly under the main spar, and rear end of the torsion spar, in the case of the single spar wing. These two bulkheads transmit the entire weight of the wing to the skid when landing, and are much stronger than the remainder. The light members are usually between  $\frac{3}{8}$ " square, and  $\frac{1}{2}$ " square. The bulkheads are held apart by longerons, these being braced stiff by diagonal members in the case of fabric covered fuselages. They are not used, however, in the case of the ply covered fuselage, other than between the two main heavily loaded bulkheads.

**LONGERONS:** These are the members of the fuselage running from the nose to the stern post. There are usually four. One in each corner where the fuselage is square, and six where the fuselage is of hexagonal section.

The lowest of these members is generally much stronger, in order to take the strains imposed by the skid which is attached to it. It is sometimes referred to as the Keel runner.

**THE KEEL:** As mentioned above, this is formed by the lowest member of the longerons, the skid on which the machine lands being screwed to it. Keels are used in the construction of intermediate Gliders such as the "Tottenho," with the object of offering the pilot protection in the case of minor crashes. It is usually of box section, similar to a box spar approximately 1" to 1½" wide, and up to 1' deep, tapering off to zero at either end. Actually, in the case of the "Tottenho" design, this member did not run back as far as the stern post, but tapered off to a position approximately half way between the stern post and the wing.

**SKID:** This is an ash runner between five and eight feet long, and between 3½" to 6" wide. It is ½" to 1½" thick, tapering both in width and section, and is attached to the fuselage with various springing devices. Rubber blocks, rows of tennis balls, or a long pneumatic tube, such as a straight piece of car inner tyre tubing, are common practices. The most popular of these, however, is the rubber block, due to its simplicity and easy replacement.

The skid is usually made of ash or hickory, and on high class machines is laminated with a thin layer of ply to prevent splitting. It is commonly sheathed with a thin strip of steel, which makes the final contact with the ground.

**THE TAIL SKID:** This is usually a spoon shaped metal cap on the end of a leaf spring, and on high performance machines there is interposed between this cap and the lower surface of the fuselage, a tennis ball held in position by a leather covering. On training type gliders, the tail skid usually consists of a swelling on the underside and rear end of the fuselage, sheathed with a light metal cap to prevent wear.

**SPLICING AND SCARFING:** This is the term applied to the joining of two separate pieces of material where long members are required, such as wing spars. The length of a splice or scarf is usually twelve to fifteen times the thickness of the member, or sheet of ply wood. (See sketch No. 15.)

In fact, Air Ministry regulations insist that a scarf must never be less than 1 in 12. In the construction of wing spars for high performance sailplanes with large spars, scarfs are frequently 1 in 20 to 1 in 30.

Splicing or scarfing plays a very important part in the construction of gliders generally, and in the case of the Monacoque fuselage, this practice is repeated many times, especially round the cockpit and nose of the machine, where double curvature is called for. The splicing of flexible steel cables is called for to a large extent in the manufacture of gliders, and this requires considerable practice. It is produced by passing the cable through the eye-let of a turn-buckle, or similar fitting, and weaving the loose strands back into the main cable. The method of weaving is identical to that used on ships.

LAMINATION.

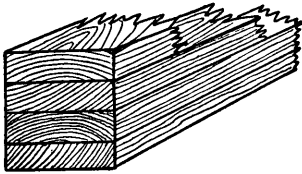

COMPOUND  
LAMINATION.

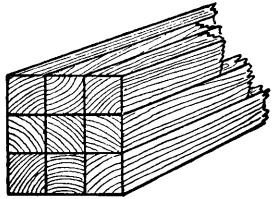

SPLICING.

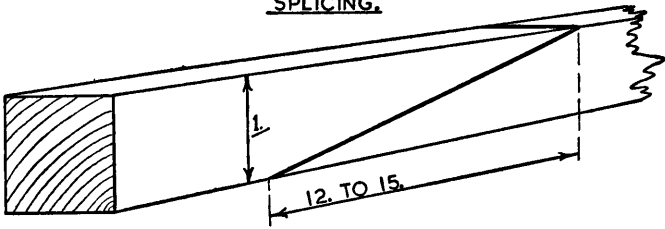

SPLICING.  
PLY WOOD.

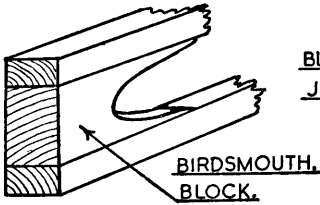
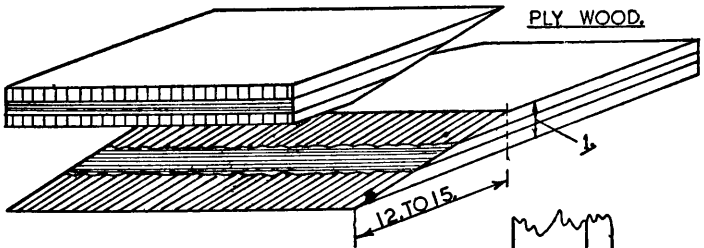

BLOCKED.  
JOINT.

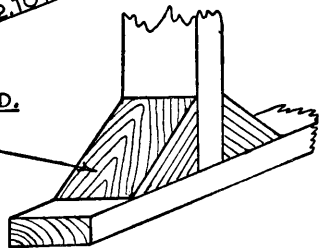

No.15.

**TURN BUCKLE OR STRAINER:** This is a small standard fitting made in three parts, having a central body, which is usually round, although sometimes hexagonal.

It usually varies in length from 2" to 6" in accordance with the strain it is intended to take. One end of this body is right-hand threaded, and the other left-hand threaded. A bolt with usually an eye or a fork, is screwed in each end, and when in position the cable to which these eyes or forks are attached, can be adjusted by turning the centre portion of the turn buckle. The most popular turn buckle used in the controls and bracing wire of gliders has a fork one end, and an eye the other, and importance should be placed on the fact that when taut, the threaded portion of the outer forks and eyes are completely covered by the centre body.

**GUSSETS OR BISCUITS:** These are small ply wood discs which are used on all joints where the rib picks up with the spar trailing edge, also corners of bulkheads, frames, etc. They vary in size and thickness proportionate to the loads they have to transmit, and the member to which they are attached.

**CORNER BLOCKS:** These are small wooden blocks inserted in corners formed by longerons and bulkheads, and are inserted to stiffen the wood where one member picks up another. They are needed in aircraft construction as the normal type of joint met with in carpentry and joinery, such as dovetail and half-joints, are never used. (See sketch No. 15.)

**BIRDS MOUTH BLOCKS:** These are blocks which are inserted between the upper and lower runners of spars, and are shaped to prevent an abrupt change of section, which would give rise to uneven loading resulting in ruptures in the upper and lower flanges of a spar when under load. (See sketch No. 15.)

**STRESSED SKIN:** This term refers to the outer ply covering of wings and fuselage, and it is intended to take torsional and bending loads. Fabric covering of wings or fuselage is not referred to as stressed skin, as despite the fact that it takes air loads, it is usually incidental, and not by design.

The importance of damage to an outer skin taking torsional and bending loads cannot be over estimated, as should such a skin become scratched or damaged, it is proportionately weaker in that area to the depth of the scratch. When it is realised that the stressed skin on the average glider is frequently less than one-sixteenth of an inch thick, this point will be readily appreciated. Perhaps the most important part of a glider to watch for such damage, is the leading edge of the wing.

**LAMINATING:** This term refers to the glueing or sticking together of two or more thicknesses of material. Ply wood made up of three or more thin veneers is to-day cemented together by a bakerlite compound which is of a fundamentally watertight nature. Spar runners of Cantilever machines are invariably laminated, as it is difficult to obtain lengths of material free from defect. Analogous with this point, it

will be recognised that it is difficult to know just what timber is like in its centre, particularly where you have squares up to 3", 4" and 5". The cutting of runners into thin layers, and reversing of same alternately, not only has the advantage of offering considerably greater strength, but it also avoids any shake which might start in the timber due to drying out. Where laminations are of extremely thin section, and are then impregnated with glue in order to build up the final thickness, the result is known as improved wood, with every justification for the term. (See sketch No. 15.)

**COMPOUND LAMINATIONS:** This term refers to laminations in which the members to be joined run in two directions at once (see sketch No. 15), where, for example, a longeron member  $\frac{3}{4}$ " square is made up of nine pieces, each section being glued and clamped together at the same time after being bent and held to the required shape. This form of lamination is chiefly used when building or repairing the nose of a fuselage which is in one piece; the longerons having the bend in two directions at the same time to form the necessary shape. In actual fact most high performance machines are built with detachable nose pieces to enable ready adjustment and easy replacement of the rudder pedals to be made in the event of damage.

**CONTROL HORNS:** These are short levers protruding from the control surface on which control cables pick up. They are usually made of laminated wood fitted with copper bushes at the ends to which the control cables are attached.

**TORQUE TUBE:** This is part of the joystick control assembly. The torque tube itself runs down the centre line of the machine, although in some cases it has been used running at right angles to the centre line of the fuselage. This method of construction is, however, seldom used. In the case of the former it runs under the pilot's seat to the rear surface of the main bulkhead in which it is supported by a bearing. The rear end of the torque tube is fitted with a cross lever by means of which side movement of the joystick is transmitted to the aileron controls, the final connection being made by push rods.

**PUSH RODS:** Push rods are steel tubes used to connect the controls to the main tube operated by the joystick, an example being that mentioned in the chapter under Torque Tube. Push rods have one disadvantage in that they call for a number of bearings in which inevitable wear takes place resulting in backlash and consequent lack of "feel" of the control surface. Flexible cables are frequently employed to overcome this disadvantage, and providing the cables run through fibre or copper guides to avoid sagging and are adjusted to the correct tension, their use is to be recommended.

**RUDDER BAR:** This method of rudder control is seldom used other than for primary gliders of the "Dagling" type. It is usually made of ash or metal tubing pivoting in the centre, the rudder control cables being attached at each end. Rudder bars occupy too much space to be used in high performance sailplanes and are generally replaced by pedals.

**RUDDER PEDALS:** These are actually made of wood of approximately the size and shape of the human foot. They are hinged at the bottom and are almost identical in operation to the brake or clutch pedal of a car. Certain designers, however, favour the fulcrum at the top with the pedals hanging pendulum fashion from it. This results in a similar movement to the rudder bar.

**DETACHABLE FAIRINGS:** These are strips of ply or metal frequently pre-formed to fit the particular joint they are intended to fair in. They are, as a rule, in positions such as where the wing meets the fuselage, etc., and are inserted after the final rigging.

**INSPECTION DOORS:** These are small detachable doors or sliding panels built in at points of the machine where it is necessary to make occasional internal adjustments to the controls. They facilitate the inspection and oiling of the various moving parts.

**COCKPIT COVER:** This is a detachable portion of the fuselage which allows the pilot easy access to his seat, and in some cases is completely detached from the fuselage, being fitted into position after the pilot has seated himself. On most modern machines they are hinged to one side of the machine and fastened in position by a catch inside the cockpit. Careful attention must be paid to this latter detail as it is important that the cover should not fly free during flight. Cockpit covers vary in design, some being fitted with a completely transparent housing enclosing the pilot, others with only a short wind shield, leaving the pilot's head exposed to the air flow, the latter being favoured for intermediate machines and early aerobatic training.

**DOPING:** This is a process carried out on the fabric after it has been fastened to the wing frame, the treatment having a tautening effect as well as waterproofing the covering. It also increases the strength of the fabric considerably. Three or four coats are usually applied to obtain the necessary degree of tautness, and to make the surface as smooth as possible. After each coat of dope the whole surface is rubbed over with very fine glass paper or steel wool, and allowed to thoroughly dry before the next coat is applied. Dope itself consists as a rule of a solution of non-inflammable celluloid known as acetate sheet which on drying shrinks to a thin film, the tightening being caused by the dope penetrating between the threads of the fabric and then contracting. It is therefore important that the first coat of dope be brushed well into the fabric to ensure penetration. On no account should this first coat ever be sprayed, although this may be practised with success on the third and fourth.

The surface of the wings after the necessary doping is generally finished with one or more coats of good quality yacht varnish, or specially prepared aircraft varnish. Transparent dope is favoured for sailplanes, as it is considerably lighter than that containing pigment or colouring matter. On the other hand, whilst it is lighter it does not offer the same protection from the rays of the sun as aluminium pigmented dope which is sometimes used.

## FUSELAGE FORMS.

The simplest form of fuselage is the square fuselage which is sometimes set on edge making a diamond as viewed from the front. This shape of fuselage did not, however, enjoy any great popularity.

The hexagonal fuselage is a shape of very rigid inherent construction, having six sides.

The Monacoque fuselage is one which is to be found in most high performance sailplanes. It is oval, round, or pear shaped. The plywood skin covering takes all torsional loads, the frame needing no diagonal bracing for this purpose. They have become almost universal on account of their cleanliness, which results in the minimum of friction in their passage through the air, their strength to weight ratio and the fact that they have all the stiffness common to tubular form. It is, of course, a more difficult task to repair this form of fuselage than the simpler types, and is, therefore, not often seen on training machines. Perhaps the most popular of these sections is the pear shape for really high performance models, as the broadest width of the pear shape lends itself to the accommodation of the shoulders of the pilot, thereby enabling the minimum of head on area to be presented to the air and resulting in a minimum of displacement. (See sketch No. 14.)

# FUSELAGE SECTIONS.

RECTANGULAR.



DIAMOND.



HEXAGONAL



CIRCULAR.



OVAL.



PEAR.



## TYPICAL GLIDER INSTRUMENTS.

**AIR SPEED INDICATOR OR ANEMETRE:** This instrument which is mounted on the panel in front of the pilot indicates the speed of the machine relative to the air, and not that relative to the ground. The speed relative to the ground has to be estimated with a knowledge of the speed of the wind at the time. This will be readily understood when one considers the case of a machine gliding at the rate of 30 miles an hour into a wind with a speed of 10 miles an hour. This would give the machine in relation to the ground a total speed of 20 miles per hour. On the other hand, a machine with a similar speed but travelling in the opposite direction, *viz.*, with the same wind, would have a speed of 40 miles per hour in relation to the ground.

Air Speed Indicators as fitted to gliders and sailplanes are usually of the diaphragm type with low pressure on one side and high pressure on the other. They usually register from zero to 80 miles per hour, it having been found that registering higher speeds than this renders them unreliable or less sensitive at low speeds, whereas it is at low speeds that accuracy is demanded by the pilot in order that he may hold a speed from which he obtains most efficiency.

The manner in which this instrument operates is indicated in sketch No. 17. This illustrates what is known as a pilot head and consists of two tubes usually mounted on a bracket well forward in the nose of the fuselage. The lower tube is cranked down to prevent moisture running through to the Air Speed Indicator, the end of this tube being open to the air flow. It is known as the pressure tube and conveys air to one side of the diaphragm of this instrument. The second is known as the static tube. It is plugged with a rounded end and then drilled with a series of small holes in its circumference and is connected to the other side of the diaphragm. The connection is commonly made with a substantial rubber tube, stiff enough to prevent a collapse under its own weight. It is as well to disconnect the

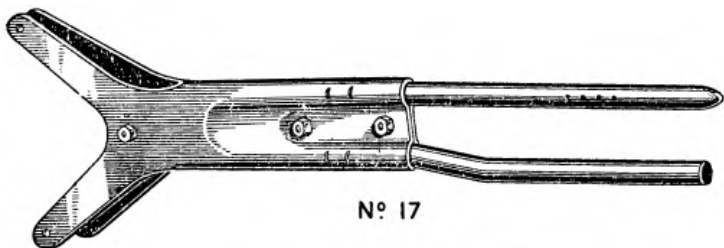

Nº 17

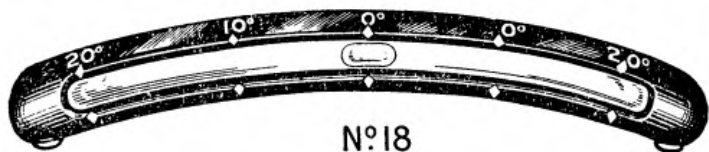

Nº 18

pressure tube from the Indicator when leaving the machine in a hangar, as many a pilot has been the victim of a pair of youthful rogues in partnership, who take it in turns to blow down the tube while the other goggles at the instrument.

**CROSS LEVEL:** This is an instrument similar to a spirit level, consisting of a glass tube with the inevitable bubble. Its form is curved and it registers from zero to 20/25 degrees on either side. The instrument is intended to indicate to the pilot when he is flying level with the horizon. It is usually situated centrally at the top of the instrument panel in a light alloy casing (see sketch No. 18).

**PITCH INDICATOR OR "FORE AND AFT" LEVEL:** This instrument consists of a triangular glass tube with a bulb blown in one corner of the triangle, the whole being mounted in a light alloy casing. It works with the glass tube in the vertical, the level of the liquid

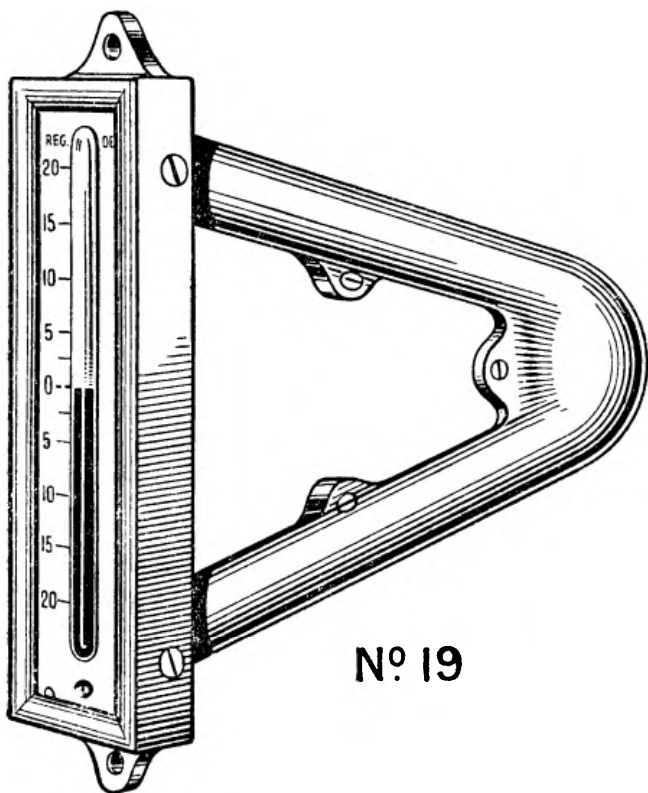

Nº 19

which is coloured registering zero at a line half way up this tube, the instrument being set in the machine with the fuselage in flying position. It furnishes the pilot with a further check on his air speed in addition to its true purpose, which is explained by its name. Its principal use is, of course, in blind flying. (See sketch No. 19.)

**ALTIMETER:** This is an instrument of considerable importance especially to the sailplane pilot who is making a cross country flight, as on these occasions his view is frequently completely obscured by clouds through and into which he may be flying. At such times he must rely entirely on this instrument, particularly when gliding across high hills and mountains, as it is possible under certain conditions for clouds to be at hill-top level. The Altimeter works on the same principle as an Aneroid Barometer, consisting of a thin round airtight metal box which has been exhausted of air and so is susceptible to atmospheric pressure changes. As these changes take place, the box contracts or expands, and by means of a point of contact on the corrugated surface of the box registers through gears to an indicator on the dial. This is,



of course, geared to register scientifically the extent of these changes. In the case of the Aneroid Barometer, changes in air pressure are registered at ground level with an indicator in keeping with the range to be expected at that level. In the case of the Altimeter which is marked off in hundreds and thousands of feet, the dial is adjustable to allow the instrument to be set at zero on any given day to correspond with the mean weather conditions prevailing.

It must be borne in mind, however, that the Altimeter has one limitation—in that it is only capable of registering the height at which the machine may be flying in relation to the ground level from which the flight began, and not the ground level over which the pilot may find himself at any point during his subsequent flight. (See sketch No. 20.)

**THE VARIOMETER:** This instrument registers with extreme accuracy the vertical sinking speed of a machine, and is particularly important to the pilot who indulges in thermal soaring, etc. It is sufficiently sensitive to register quite small movements such as a sharp lift of five to six feet. The instrument takes the form of a block of transparent material on the instrument panel, being drilled with two fine tapered holes. In these holes are two light pithy balls, one red and the other green. The red ball registers the sinking speed of the machine, while the green measures the speed of rising. A particularly good example of this instrument is to be found in the Slater Cobb.

The principle on which the Variometer works calls for the use of a Thermos flask such as may be purchased in any chemist's shop, although two of these are generally coupled together in order to obtain the volume necessary to the efficient working of the instrument. For the purpose of explanation, however, they will be described as one. A Thermos flask is used to avoid any interference due to change of temperature which could otherwise expand or contract the air inside a normal container, and so cause a false reading to be given on the instrument. The flask is connected to the Variometer by rubber tubing, the tubing being kept as short as possible to still further guard against undue pressure changes. As the machine gains height air passes out through one of the small tapered holes drilled in the instrument, and so lifts the green ball and indicates the rise in feet per second. Conversely, when the machine descends, air passes in through the tapered hole in which the red ball is located, and indicates descent in a similar manner. When neither ball registers either rise or sink, the machine is flying in a region of up-moving air equal to the vertical sinking speed of the machine itself. (See sketch No. 21.)

**THE BAROGRAPH:** This instrument records by means of an ink line on a chart the maximum height attained at any given period of flight. It is usually carried by sailplane pilots when attempting records. The mechanism is exactly the same as the Altimeter, the only difference being that instead of a dial, the pointer registers movement on a moving chart driven by clockwork. Of necessity, however, the diaphragm containers must be somewhat larger and more powerful to overcome any friction set up by the pen making contact with the record chart. (See sketch No. 22.)

Height  $3\frac{1}{2}$ " width  $\frac{1}{2}$ " depth 1". Weight  $\frac{1}{3}$  of an ounce.

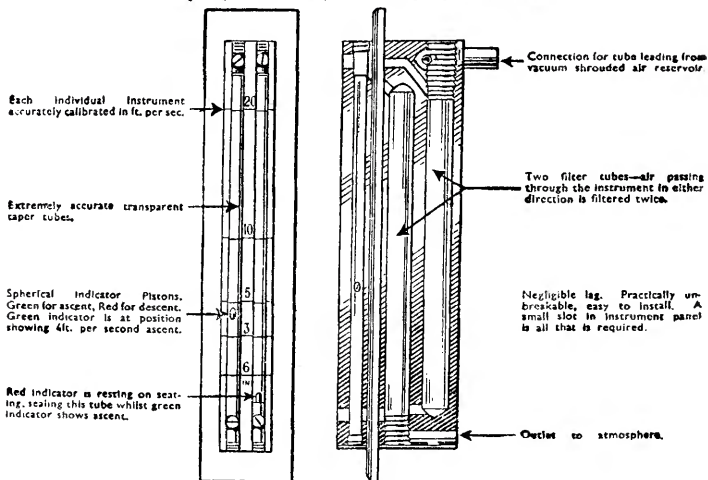

Nº 21

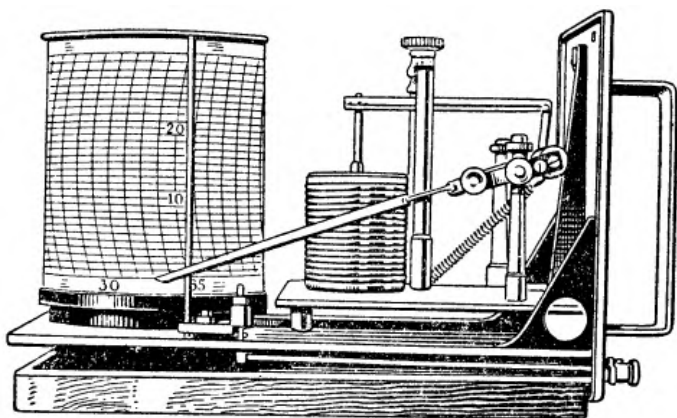

Nº 22

**TURN OF BANK:** This instrument is used almost solely for blind flying through clouds, and indicates to the pilot whether he is level and straight, or otherwise. It consists of a gyroscope which is driven either by air pressure through a venturi-tube or by a very light electric motor, being fed as a rule by a bank of small torch batteries. These have a comparatively short life, and they are switched on only when entering cloud cumulus. (See sketch No. 23.)

**COMPASS:** This instrument is identical with that used in any type of aircraft, being suspended in liquid to damp any sudden or sharp movement of the machine. It is, however, rather lighter in construction than that used in power craft.

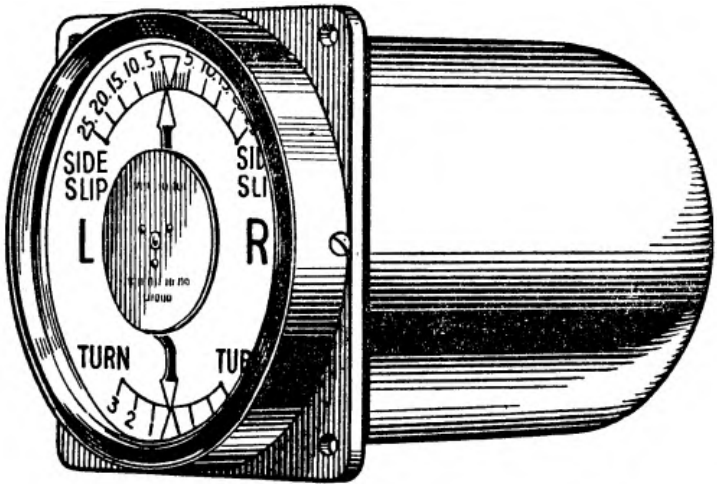

Nº 23

### ADDENDUM.

The following suggestion was never intended to become part of this brochure but a number of flying friends to whom I communicated the idea outlined hereunder, advised me that as I do not wish to capitalise the suggestion, the present time was perhaps appropriate to giving it some form of publicity. I, therefore, offer the suggestion for what it is worth to the vast numbers of people interested in gliding at the present moment, and who may be in a position to modify and develop it.

Sketch No. 24 illustrates a proposed method of facilitating and speeding up the early stages of gliding for those with no previous experience. As will be seen it is a comparatively simple mechanical device mounted on a normal car type chassis or three wheel trolley made for the purpose and enables the first stage embryo pilot to experience in very much less time than the normal method takes, the feel of a glider which is airborne. All glider pilots remember the unconscionable time which elapsed before they were able to enjoy for any length of time the feel of being in control of a machine flying in its proper and pre-designed element, and the equally irritating but very necessary journeys back to the starting position before another small hop could be essayed. Not only is all this cumbersome and protracted paraphernalia eliminated but all the minor risks also, and the pilot from the word "go" is able to learn the feel of the controls of the very machine which, a preliminary training period over, he will finally soar in. In detail the device consists of a firmly located hollow pylon with an inner sliding member to which is secured a circular disc. Above this disc, and attached thereto, is a universal joint which couples with a similar disc, carrying a special attachment to which the machine itself is secured. The universal joint gives a movement in any and all directions limited by the discs themselves which prevent any given angle which the machine may assume during semi flight from becoming too great. In fact, the design relies for its efficiency on the careful measurement which must of necessity be worked out to conform to normal flying angles between the discs in question. The inner tube or sliding member is restricted in its movements in a vertical plane by a key which runs in a slot in the outer tube, and the weight which it would otherwise add to the weight of the machine itself is offset by a counter-balance to the key protruding through the outer tube over a pulley at the top of the pylon. This counter-balance is itself running in a light tube giving it freedom to slide but preventing it from swaying. It will, of course, be appreciated that a degree of experimentation is necessary before the proper area covered by the trolley itself is arrived at, and it would appear, without having put it to the test, that this should be given a fairly wide track. It should also, to offset possible tipping when light gusts of wind are encountered, be loaded at its extreme points. Certain other apparent difficulties exist in the idea. The first and perhaps the most prominent of which is the maintenance of the machine in a stationary position before and during the pilot's entry. This point could be covered by the imposition of three wedges between the discs above and below the universal joint, and the trolley equipped with a collapsible ladder by means of which the pilot could climb into the cockpit. Quite naturally the height of the central tube mechanism would have to be proportionate to the track of the trolley, the greater the height of the former necessitating a longer and

## PROPOSED TRAINING DEVICE.

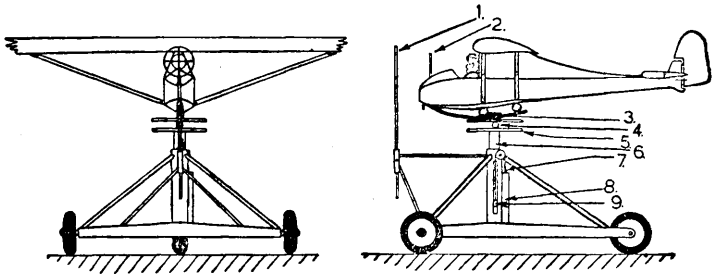

1. VERTICAL & HORIZONTAL LINES ADJUSTABLE. 2. LINES FIXED  
 3. ATTACHMENT DEVICE. 4. UNIVERSAL JOINT. 5. CIRCULAR DISCS.  
 6. CENTRAL TUBE. 7. BALANCE WEIGHT. 8. TUBE FOR WEIGHT,  
 9. KEY TO LIMIT VERTICAL MOVEMENT.

### No. 24.

wider track on the latter. The device is completed with the addition of a light tube frame attached to the front part of the trolley or car, the frame being fitted with a circle in which a cross is inserted, the cross running through the vertical and horizontal planes, and being adjustable so that it could be set at the various heights. A similar cross, but smaller, could be attached to the top member of the nose of the glider, the idea being that in the early stage of training the pilot could be instructed to keep the glider level, both with ailerons and elevator controls, and would be compelled to bring the rudder into use by sighting the rear cross with the larger or fixed cross. At different stages in this training the fixed cross could be moved up and the pilot be made to keep the machine at a level approximately half the permissible vertical movement of the mechanism, the instructor being at the same time in a position to see that instructions were being carried out. He would also, whilst travelling in the car towing the trolley, be in a position to watch the reactions of the pilot and the manner in which he operated the controls.

The whole scheme has, to my mind, the following fundamental advantages:—

1. The pilot rapidly learns the feel of the controls at flying speed.
2. No risk whatever is involved.
3. The great reduction in the number of personnel required with the normal and what I feel inclined to term "the old fashioned method of launching."
4. The similar reduction in the time involved in retrieving machines and towing back to the starting point.

5. The instructor travelling in the car towing the mechanism, could maintain contact and conversation with the pupil under instruction.
6. The greatly increased time which the pilot would spend at the controls by comparison with the time he could spend formerly.
7. The reduction of wear and tear to the machines during possibly the most damaging time in their life.
8. The probability of the early disappearance of the open primary glider reducing the previous expense incurred by the average club and enabling the pupil to start his flying in a far more sailplane-like craft.

The author invites comment on the above, acrid or otherwise; if otherwise he will be pleased to offer any constructive criticism or assistance which his rather limited leisure now permits.

### USEFUL TABLE OF WIND SPEEDS.

Description of Wind.	Indication of Wind Speed.	Speed of wind taken at 25 to 30 feet above ground level.
Calm ... ..	... Smoke rises vertically... ..	Less than 1
Light air ... ..	...Wind direction shown by smoke drift but not by wind vanes ... ..	1—3
Slight breeze ... ..	...Wind felt on face; leaves rustle; ordinary vane moved by wind ... ..	4—7
Gentle breeze	...Leaves and small twigs in constant motion; wind extends light flag... ..	8—12
Moderate breeze	...Raises dust and loose paper; small branches are moved ... ..	13—18
Fresh breeze ... ..	...Small trees in leaf begin to sway ... ..	19—24
Strong breeze	...Large branches in motion; whistling in telegraph wires ... ..	25—31
High wind ... ..	...Whole trees in motion... ..	32—38
Gale ... ..	...Breaks twigs off trees; generally impedes progress ... ..	39—46
Strong gale ... ..	...Slight structural damage occurs; chimney pots removed ... ..	47—54
Whole gale ... ..	...Trees uprooted; considerable structural damage ... ..	55—63
Storm ... ..	...Very rarely experienced; widespread damage ... ..	64—75
Hurricane ... ..	...	Above 75

was 15.38 kgs/sq m.

The British Soaring Movement, despite the difficulties which followed its inception in the early thirties, made steady progress, and in the two years before the outbreak of war, was firmly established on a sound basis. This was due in some measure to the introduction of a small Government subsidy which, even to the unbiased observer, can be seen to have yielded results up to the period of hostilities. With a settled background, the leading members of the soaring movement could at last plan for future development instead of merely carrying out short term policies which, up to that time, were unworthy of a great air power. Under the new circumstances, it became increasingly obvious that the particular conditions of climate, geography, and prevailing winds affecting Great Britain, called for a slightly different soaring technique as compared with that adopted in large land masses such as Western Europe, the USA, and Northern Asia. This, in turn, led to a different approach to the design of high performance sailplanes and 1938 found Britain

at the beginning of a new phase; new ideas were being discussed and in many cases tried out, but the outbreak of war and its subsequent duration largely nullified the work which was carried out.

Among the new types of sailplanes introduced, were the Viking Mk1 single seater, followed by the VIKING 2 2-seater.

### The VIKING 1.

W.R.Scott, designer of the Vikings 1 and 2, founded the firm of Scott Aircraft Ltd at Dunstable, and the first machine to be put into production was the Viking 1. This was specially designed to give a high performance, without excessive wing span and to maintain a low rate of sink at high cruising speeds. In addition, it incorporated several novel features not previously installed on any production sailplane.

Construction throughout was of wood on conventional lines, with all attachment fittings made from steel to aircraft specification. The ply on the rear fuselage skin was attached with the grain running diagonally ie. in any bay, the

Technical data	
Type	VIKING 1
Wing Span:	51 ft.
Length:	20.5 ft.
Root Chord:	4.1 f.
Tip Chord:	2.3 ft.
Taper ratio :	1.78:1,
Wing Area:	169 sq. ft.
Aspect Ratio:	15.4.;
Empty weight:	370 lbs.
Wing Loading:	3.2 lbs /sq.ft.

grain went from top front to lower bottom corners, thus substantially increasing the strength and stiffness in flight and, equally important on sailplanes, when ground handling. In the lower half of the fuselage, two light stiffeners between each bulkhead to further reinforce the ply against buckling. The cockpit was upholstered with leatherette and the nose fairing detached to permit adjustment of the rudder pedals. The tailplane was attached to the fuselage by 3 bolts which picked up on hank-nuts permanently fixed to the fuselage. The elevator control connected automatical-

These pages: all Scott Viking 1s. C. Wills thinks that its max L/D is better than 19.4 to 1.

Photos: all from VGC Collection.

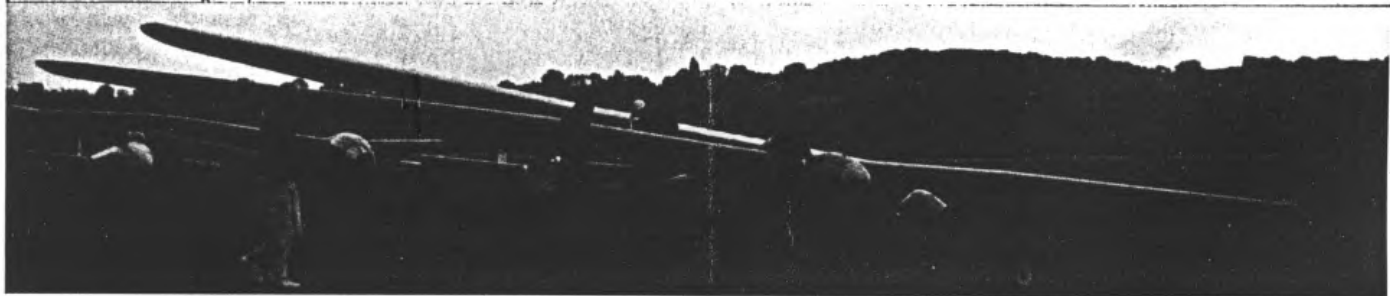
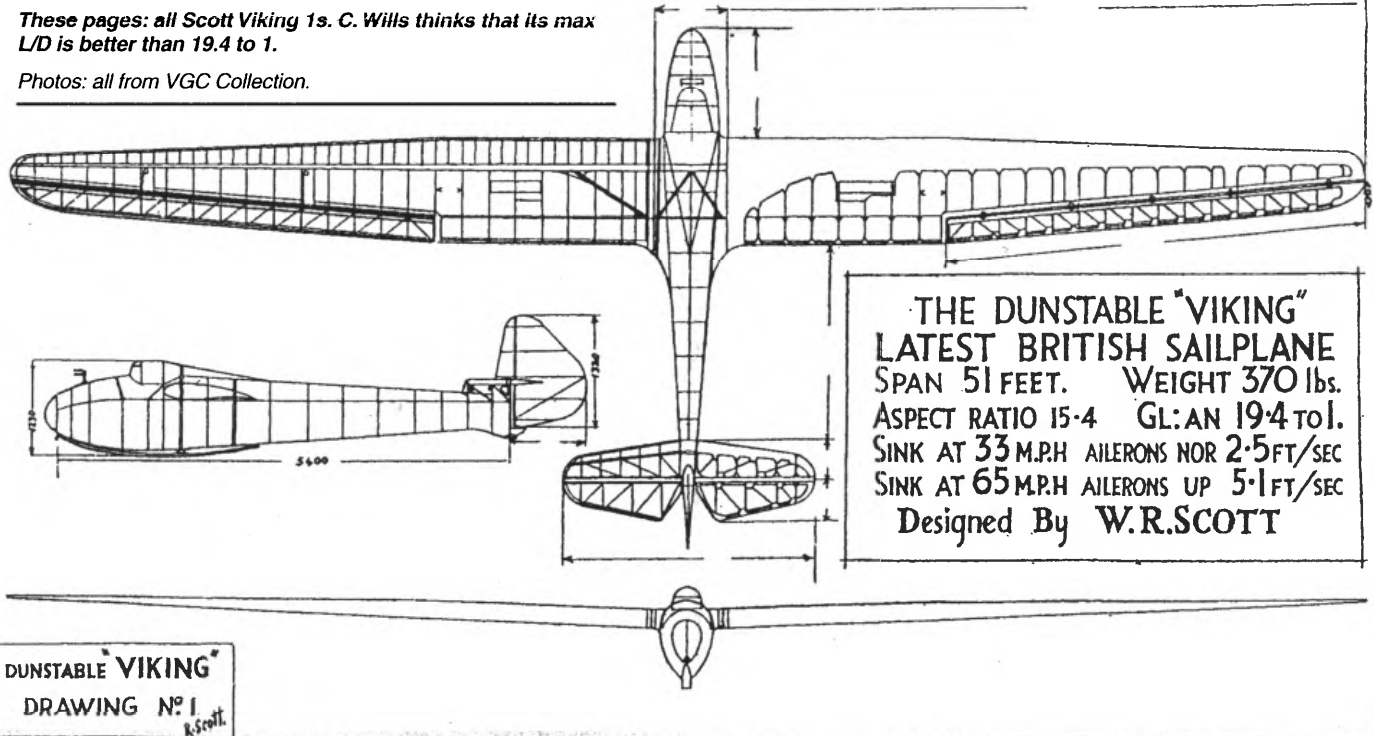

# The SCOTT VIKING 1

An example of this sailplane has recently been bought by Mike Beach and it has been flying from RAF Halton where it has caused very great interest on the ground and in the air, where it has been impressing everyone with its good performance.

BGA 416 was one of four Viking 1s built and received its first BGA C of A in June 1939. The first was taken to the Argentine by Philip Cooper, where it flew some records and proved to be rather faster than a Condor 1 which, until then had been the highest performance sailplane in Argentina. The other two Viking 1s were impressed at first into the Special Duties Flight in July 1940 to try out radar off the South Coast. They did not survive their wartime military service. The 4th, BGA 416 is still with us. After the war, it was flown from a bungee launch into a 70 knot wind, to 4,721 metres in wave by George Thompson. Thompson followed this with a similar ascent a few weeks later.

In 1937 Hans Zander and Roy Scott set up a new business in England and, in 1938, Scott's Viking sailplane was advertised. Scott avoided expensive features such as gull wing dihedral. The wing root required no detachable fairings, the Viking's wings

being attached by a vertical steel expanding bolt, inserted and tightened from above. A strong "carry through" structure was built in to the main fuselage frame. The small pin at the rear attachment point was also inserted from above. Rigging was easy. The ailerons were automatically linked when the wings were attached. The ailerons themselves were differentially geared. Instead of the usual central hinge line with round plywood tube aileron spar, the Viking's hinges were located on the top wing surface, perhaps not so efficient aerodynamically, but cheaper to make and easier to dismantle for maintenance. By means of a ratchet lever in the cockpit, the ailerons could be trimmed Up or Down together to act as camber flaps. The Aerofoil section was Gottingen 535 at the root but was symmetrical at the tip, while the tail was somewhat like that of the Minimoa, the tailplane being carried

on a sub-fin, lifting it well clear off the ground. A skid was provided for landing, and the seat had space for a "back type" parachute. Performance claims were moderate with a best Glide Ratio of about 1/20 and a Minimum sinking speed of 0.76 m/sec. The Viking was test flown at Dunstable in November 1938. The prototype was sold and exported to the Argentine where it broke several local records.

Scott designed and built a 2-seat Viking 2, of 18.6 m span, with side by side seating. This was flown in 1939 and survived for some years until, when it was being test flown at Farnborough, its wing developed a flutter and the glider broke up and crashed, the pilots escaping by parachute.

Wing span was 15.34 metres, wing area was 15.89 sq.m., aspect ratio was 15.2, empty weight was 167.83 kgs, flying weight was 244.94 kgs, wing loading

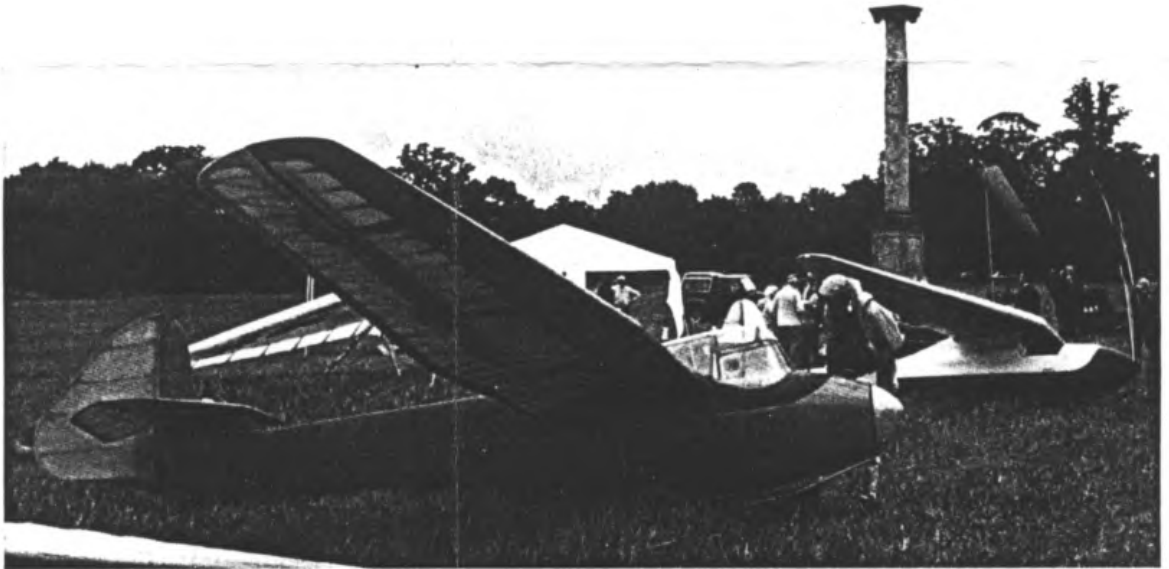

**10 Highfield Road**  
**Corfe Mullen**  
**Wimborne**  
**Dorset BH21 3PE**  
**Tel Broadstone 693883**