

AM please N 77. 13

JANUARY, 1947

1/6d.

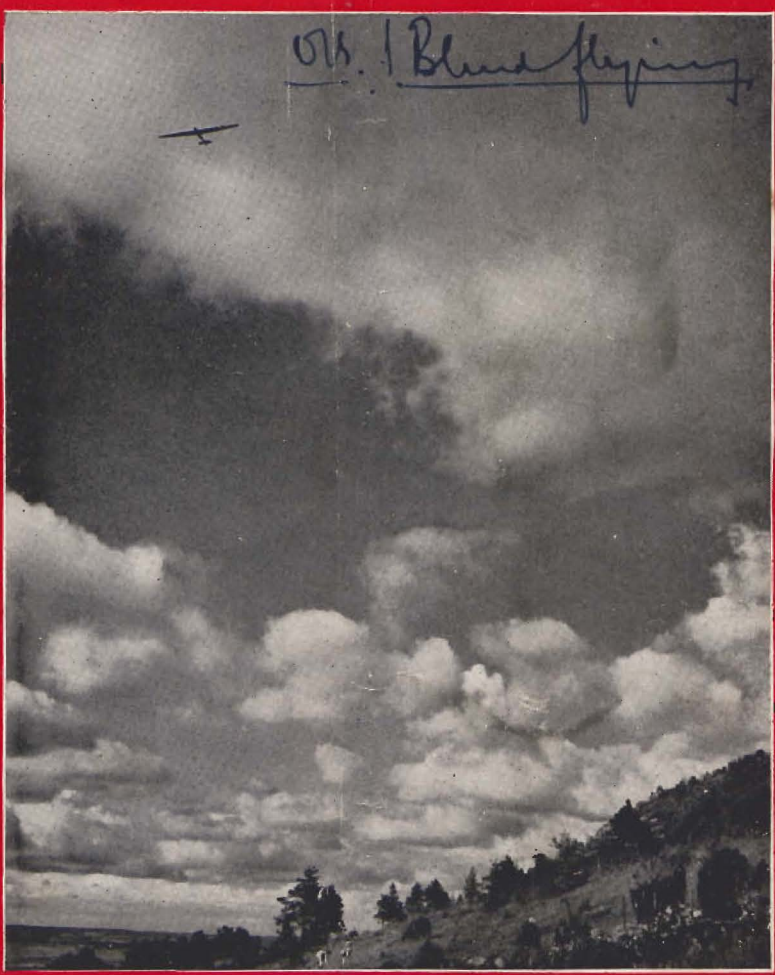

Sailplane and Glider

The First Journal devoted to Soaring and Gliding

Essential Equipment

NOW AVAILABLE

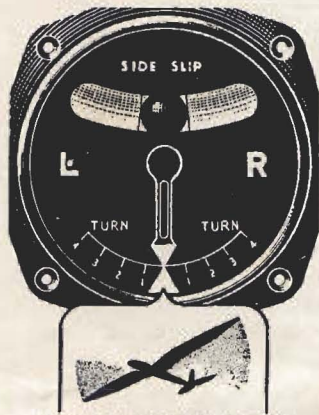

TURN & BANK INDICATOR

9v. Electrical
Operated by dry-cell batteries
Weight—1 lb. 9 ozs.



AIR SPEED INDICATOR

Special Sailplane
Calibration—20/100 M.P.H.
Weight—9 ozs.



ALTITUDE INDICATOR

0-20,000 feet
Simple robust design
Weight—12½ ozs.

K. D. G. Instruments Ltd
PURLEY WAY · CROYDON · UPLANDS 6888

Actual Size

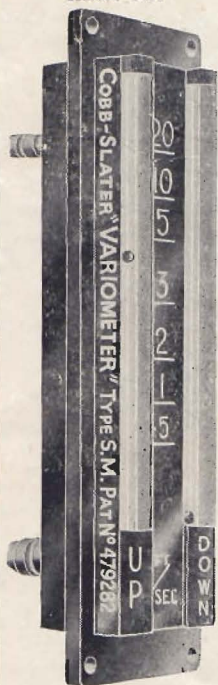

SIMPLE : RELIABLE ULTRA-SENSITIVE

MAKE SURE of contacting the smallest lift by fitting one of these famous Variometers.

DESIGNED to register immediately almost imperceptible vertical speeds yet robust enough to withstand large overloads.

NEGLIGIBLE LAG.

AGENTS ABROAD :

Australia : A. E. BERGER,
30, Edwards Avenue,
Garden City, S.C.7.
Melbourne.

Canada & U.S.A. :
J. SIMPSON, P.O. Box 562,
Ottawa, Ontario.

South Africa :
J. C. DAVIDSON, 376, Loop
St., Petermaritzburg, Natal.

Belgium & Holland :
M. PIERRE PUTTEMANS,
25, Boulevard Ferd. Campion
Vilvorde, Belgium.

Made only by
THE COBB-SLATER INSTRUMENT CO., Ltd.
MATLOCK, ENGLAND. Phone : Matlock 438.

ANY QUESTIONS?

Has it occurred to you that the Cellon technical service department may be able to supply the answer to your post-war finishing problem ? We make no wild promises, of course, particularly in these days of shortage of material ; but we feel that if we were able to solve the wartime problems which we *did* solve, then we can be more than a little helpful to you just now. We don't know what your product is—we don't need to guess—for every industrial finishing problem is our concern. We merely look forward to hearing your troubles and maybe putting you into a more cheerful frame of mind. We don't work miracles ; but we do work out the right answers. Shall we be hearing from you ?

CELLON · CERRIC · CERRUX THE FINISHES THAT STAND THE TEST

CELLON LIMITED,
KINGSTON-ON-THAMES

Telephone :
KINGSTON 1234 (5 lines)

Sailplane and Glider

THE FIRST JOURNAL DEVOTED
TO SOARING AND GLIDING

JANUARY 1947 ★ Vol XV No 1

EDITOR:

VERNON BLUNT

ASSOCIATE EDITOR:

ALAN E. SLATER

ADVERTISING

and

EDITORIAL OFFICES:

139 STRAND, W.C. 2

PHONE: TEMPLE BAR 6451/2

The *Sailplane and Glider* is published on the fifth day of every month. Price One Shilling and Sixpence per copy; 19/- per year posted. Advertising Rates on application.

Published for the proprietors, Glider Press Ltd., by the Rolls House Publishing Co., Ltd., Brems Buildings, Fetter Lane, E.C.4, and Printed by the Mendip Press Ltd., London and Bath.

CONTENTS

	Page
Editorial	1
Best Air Speeds for Thermal Cross-Country Flights	2
The "KrajaneK" (Zlin-24)	5
Dutch Gliding News	8
Blind Man's Bluff	11
B.G.A. Announcements	14
Australian Gliding Association	16
My Visit To Elmira	17
11,000 feet in the Helm Wind	19
A Pioneer of Empire Gliding	20
News From The Clubs	21
Letters To The Editor	24
R.A.C. Gliding Certificates	27

A Year for Great Endeavour

THE forthcoming year might well be a critical one for the Gliding Movement in Great Britain, and indeed throughout most of the world, especially in those countries where there is no Government aid.

For Great Britain there is much uncertainty. The new Minister for Civil Aviation seems to be prepared to listen at least to the demands of the Movement for aid, though whether he can do anything remains to be seen. There now seems to be no lack of British made machines although we could wish that the prices were more within everyone's reach.

The one place where there seems to be no apparent uncertainty, although even this may change, is in Germany, where the sport thrives in a most pleasing and encouraging manner. Indeed with the excellent available facilities, the enthusiasm of the Forces of Occupation and the skill of the German advisers, there is every reason to expect that the next great achievements in British Gliding and Soaring will be registered there. It is the nationality of the record breaker which counts, not the place where the record is made. So that we expect to hear of many attempts at British Records being made in the next few months.

In Great Britain the picture is more sombre. There exist nearly thirty clubs here, each with its complement of machines and its club house or premises, and its list of members ranging from a handful to a few hundred.

But most clubs are hard to get at, costs are high, and the number of devotees who can spare the necessary time to spend a week at a Club, waiting for gliding opportunities, is comparatively few. Few clubs are engaged in "ab initio" training, because of the cost, the time taken, and the lack of qualified instructors. Yet it is clear that the officers of the Clubs available are doing all they can, within their necessary limitations, to foster the sport. What then, is required to enable it to go ahead and capitalise the latent enthusiasm we believe to be available if means of its expression can be found?

As has been said before in these columns, we believe it is necessary to think big, aim high, and plan accordingly.

There are two aspects to the problem. The first is the question of initial cost. The second is one of sites and personnel. We believe that if a workable plan is presented to the M.C.A. help may be forthcoming. But what is workable depends on the answer to the second aspect of the problem—sites and personnel.

There is unfortunately a dearth of sites which are easily accessible to large centres of population, and it is on the latter that we must rely for the numbers of enthusiasts to make any scheme work.

Who is to find the sites and make the plan? The latter question is more easily answered than the first. Reactions to recent published ideas in *Sailplane* seem to indicate that a plan is either in process of being prepared or is ready. But in the end the whole affair will boil down to a few enthusiasts who will take the lead in forming Clubs, satellites perhaps to existing Clubs, wherever suitable sites can be found.

It is to those that the Movement must mainly look for its future expansion, and we are sure it will not look in vain. To these *Sailplane* pledges all the help it can possibly give. As a token of that help, copies have been made and will be placed at the disposal of the B.G.A., of a much praised series of articles which appeared in *Sailplane* in 1945 on "How to Form a Club." Applications for these should be sent to the Secretary of the B.G.A., Londonderry House, Hertford Street, Park Lane, W.1.

BEST AIR SPEEDS FOR THERMAL CROSS-COUNTRY FLIGHTS

By F/Lt. H. NEUBROCH

THE discussion on best airspeeds in recent issues of this journal has lead me to consider the problem of best airspeeds for thermal cross-country flights, or, to be more exact, best airspeeds while gliding between masses of rising air. Given a certain average rate of lift in thermals on a day when a cross-country flight is contemplated, the pilot will be faced with this question: in order to maintain a certain maximum height (*i.e.* the height at which he will cease to circle in rising air and will resume course, gliding towards the next thermal), what is the best gliding speed to cover as much ground as possible in the time available?

At first glance it may be thought that the best

B, five miles distant from A, where they will contact a thermal giving lift at the rate of 1 ft./sec. "Olympia No. 1" is to glide at 35 m.p.h. (*i.e.* just below the best speed for maximum distance in still air), No. 2 at 40 m.p.h., No. 3 at 50 m.p.h., No. 4 at 60 m.p.h., and No. 5 at 70 m.p.h. We want to find out which "Olympia" will be the first to regain its height at B.

"Olympia No. 5," gliding at the greatest airspeed, will reach the thermal at B before the others, after 258 seconds. The relative positions of all sailplanes at this moment is shown by their numbers in the diagram. Sailplane No. 4 will be under B after 300 seconds, No. 3 in 360 seconds, No. 2 in 450, and No. 5 in 516 seconds.

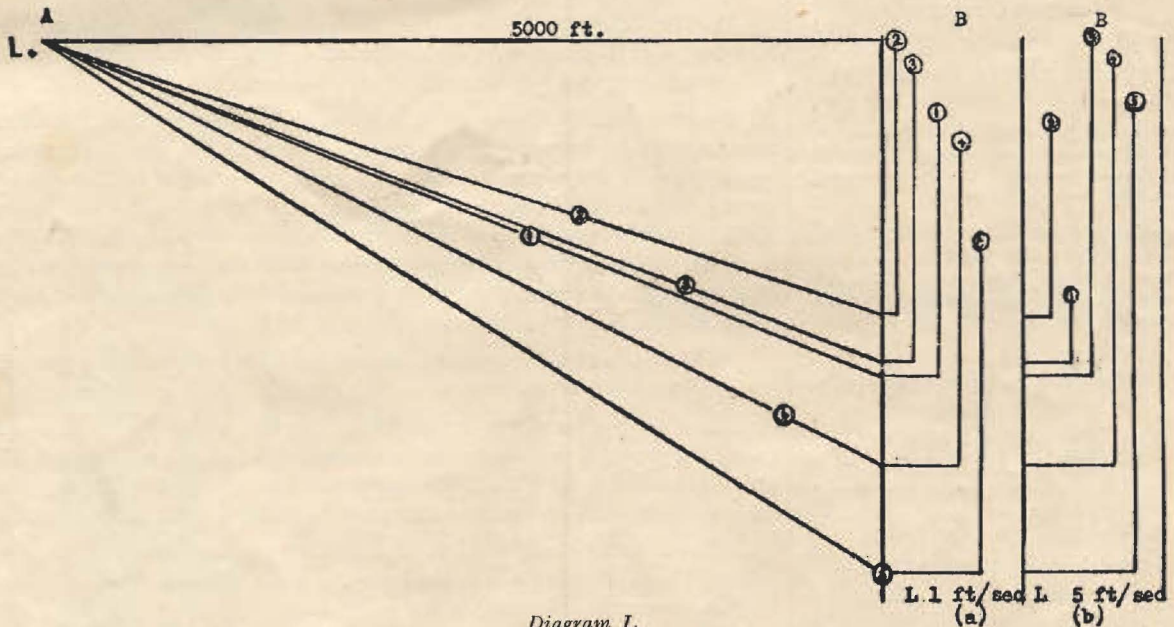

Diagram I.

gliding speed for maximum distance in still air (a constant for any one sailplane type) will be the one our pilot seeks. The following diagrammatically illustrated examples will, however, show that the best gliding speed for maximum distance *between thermals* (hereafter called *Vopt*) will always be greater than the best gliding speed for maximum distance *in still air*. It will be greater by an amount relating to the rate of lift experienced in the thermals: the greater the rate of lift experienced (hereafter called *L*), the greater the best gliding speed between thermals.

Let us assume five sailplanes, type "Olympia," with exactly similar performance figures, at a height of 5,000 ft. at Position A (Diagram I). These sailplanes are to start simultaneously and glide towards

According to the performance diagram for the "Olympia," published in the October issue of this journal, the rates of sink for "Olympia" sailplanes gliding at 35, 40, 50, 60 and 70 m.p.h. are 2.3, 2.2, 3.2, 5.1, and 7.4 ft./sec., respectively. It is now possible to tabulate the time taken by each of those five aircraft to glide from A to the thermal at B, and the amounts of height lost, as in Table A.

As soon as "Olympia 5" reaches the thermal, it will begin to climb at $L=1$ ft./sec. The other sailplanes will not yet be under B, but their more shallow gliding angle will ensure their reaching the thermal above the point at which No. 5 started its climb. They will therefore spend less time on the climb.

In this case (Diagram I a) "Olympia No. 2,"

T H E S A I L P L A N E

flying at 40 m.p.h., will be the first to regain its original height at B. The relative positions of the other sailplanes at this time are again shown by their numbers in the diagram. To accomplish the distance A—B and to regain 5,000 ft., "Olympia 1" will take 1,703 secs., 2 1,440 secs., 3 1,512 secs., 4 1,530 secs.,

"Olympia No.	1	2	3	4	5
Speed (m.p.h.) ..	35	40	50	60	70
Time taken from A to thermal at B (secs.)	516	450	360	300	258
Height lost (ft.) ..	1187	990	1152	1530	1909

TABLE A.

and "Olympia 5" will take 2,167 secs. Diagram 1 b shows what happens when L equals 5 ft./sec.

To arrive then at V_{opt} when L equals 1, we can plot these time values against speed (Diagram II) and join the points so derived by a curve. Inspection will show that V_{opt} is at 43 m.p.h.

Similarly we can arrive at time values and V_{opt} for any value of L, as in Table B.

"Olympia" No.	1	2	3	4	5	V_{opt} (m.p.h.)
Speed (m.p.h.)	35	40	50	60	70	
When L equals 1	1703	1440	1512	1830	2167	43
2 then the total time taken from A to B is (secs.)	1110	945	936	1065	1212	47
5	753	648	590	606	640	56
7			525	519	531	60
10	635	549	475	453	448	65

TABLE B.

This table shows that V_{opt} increases with L.

By plotting the values for V_{opt} obtained in Table B against values of L (Diagram III) and joining the points so obtained by a curve, we can at a glance find the best gliding speed between thermals corresponding to any rate of climb in the thermals.

We know now all the factors to enable us to calculate the average cross-country speeds corresponding to values of V_{opt} and L. Diagram IV shows how the average cross-country speed increases with increases in the value of L. These values are tabulated below:

What are the practical uses of the above considerations? Are we not assuming a set of conditions unlikely to prevail for long, if at all—constant rate of lift in thermals throughout the day, and their persistence—and will not the pilot have to take advantage of lift where and when he can find it, whatever its strength may be?

It is certainly not suggested that a pilot intending to go cross-country should ascertain the strength of

Type: "Olympia" L (ft./sec.)	V_{opt} (m.p.h.)	$V_{average}$ (m.p.h.)
0	40	—
1	43	12.5
2	47.5	20
3	51	24
4	54	28
5	56	31
6	67	33.5
7	60	35.5
8	62	37
9	63.5	38
10	64.5	39

TABLE C.

the first thermal he finds, and extract and use a value for V_{opt} which corresponds to that rate of lift. An experienced meteorological forecaster at any airport should, however, be able to predict the average strength of thermals which the sailplane pilot

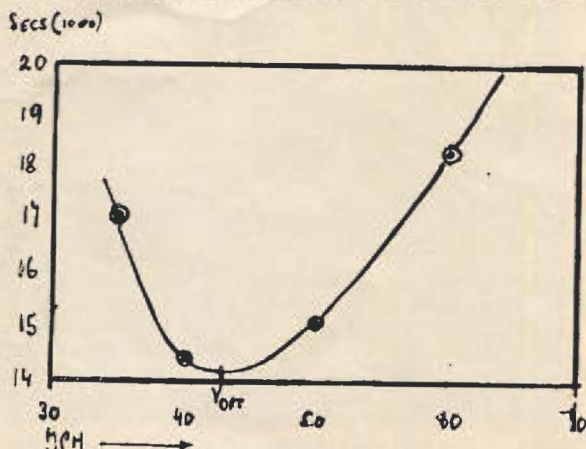

Diagram II

is likely to meet during a cross-country, taking local conditions into consideration. It stands to reason that L will probably be higher around noon and considerably less in the early morning and late afternoon and, above all, it will be necessary for the pilot to change his gliding speed in the light of observations during the flight.

To give an example: a pilot flying an "Olympia" is told by the forecaster that the average rate of lift in thermals along his proposed route during the day in question will be 8 ft./sec. From this will have to be deducted the inherent rate of sink of the glider in still air, say 3 ft./sec., leaving an average L of 5.

T H E S A I L P L A N E

The pilot will then consult a Vopt graph and will decide on a best gliding speed around noon of approximately 57 m.p.h., and on a speed perhaps as low as 50 m.p.h. for the early morning or late afternoon.

If, during the flight, he finds L to be 8, he will increase his gliding speed to between 57 and 64

be found within striking distance further along track. Once the strength of a thermal has decreased with height considerably below the average to be expected for that time and day, it may be more advantageous to leave it, and find greater lift further along track.

Let us now consider the use of the best average speed tables. Reverting to our example of a forecast average value for L of 5, Table C gives an average best gliding speed between thermals of 56 m.p.h., and an average all-over speed of 31 m.p.h.

So far we have only considered airspeed. By adding the tailwind component for the cross-country, we get the average ground-speed, and by multiplying this with the number of hours estimated as available for the trip, we can obtain a pretty shrewd idea of the distance we can cover—no mean aid in deciding on a target in the case of goal-flights.

A tail-wind of 15 m.p.h. in the above example, and a total time of five hours (values by no means abnormal) should carry us to a target not less than 200 miles distant.

If, as I believe, best airspeed curves between thermals are at least as important to the sailplane pilot desiring to cover great distances as are the ordinary performance curves (rate of sink against airspeed) than a comparison of Vopt curves for different types of sailplanes would not be without value. Diagram V shows roughly correct curves for different sailplanes. In drawing them I have, however, assumed that all types have an identical rate of lift in the same thermal which, in fact, is not the case, owing to the differences in their inherent rate of sink in still air. But as these are usually balanced

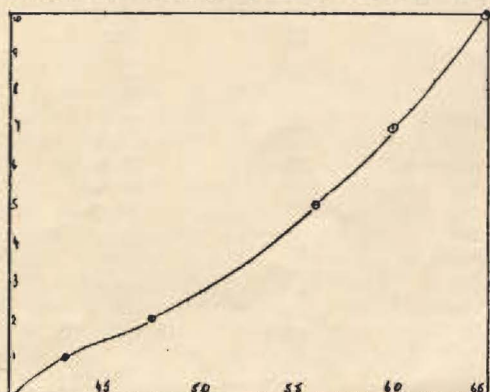

Diagram III.
Showing how V. opt.
increases with L Type
Olympic

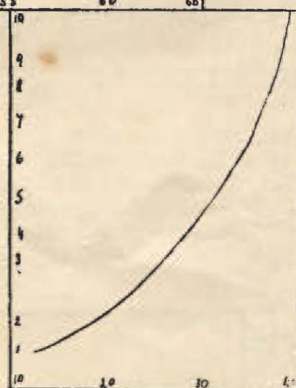

Diagram IV
Average Cross-Country speeds
increase with increases in lift

m.p.h., or to any other speed which subsequent changes during the flight demand. He will, of course, keep an eye on his altimeter. If his altitude should decrease to a level where there is any danger of a premature landing, he will fly at the best gliding speed for maximum distance in still air (40 m.p.h. in our example) while studying the ground for possible sources of lift and fields suitable for a landing. He will also change his gliding speed when approaching an area notorious for the scarcity of thermals, or when he has any reason to suppose that the rate of lift he has so far experienced in thermals will decrease.

The interpretation of best airspeed tables requires a large degree of flexibility. It is obviously much more important that a sailplane pilot should be able to find and use thermals, but being once in that position and desiring to cover the greatest distance in the time available, it will be of obvious help to him to know what airspeeds will enable him to make the best use of conditions.

In this connection it is suggested that thermals need not be used to their maximum height, provided that other thermals may, with reasonable certainty,

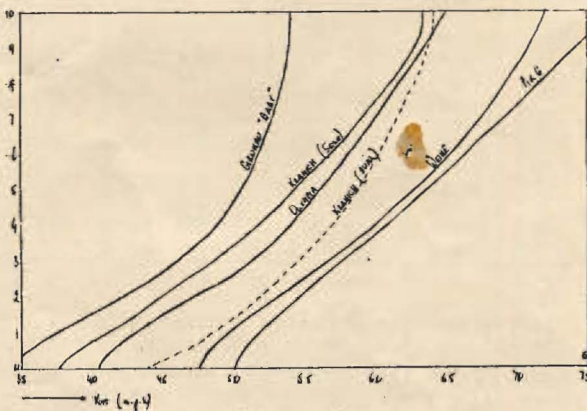

Diagram V
Best Airspeeds between Thermals for : Olympia, Grunau
"Baby," Kranich Solo and Dual, Weine and P.K.6.

by the use which different sailplanes can make of the same thermal (slower sailplanes with a smaller radius of turn can make better use of the strong core of a thermal) the resulting inaccuracies can be largely disregarded.

Last but not least: tables and graphs for Vopt and resulting average speeds for all types of sailplanes can be calculated from ordinary performance curves (rate of sink against airspeed). No other information is needed. All the above calculations are based on performance graphs published in the October number of this journal.

THE "KRAJANEK" (ZLIN-24)

A Czechoslovakian sailplane of interesting design.

Described by - - - T. Rex Young.

A RECENT visit to Czechoslovakia provided the opportunity to examine, and fly, a production model of the "KrajaneK" intermediate sailplane, an original Czech design of considerable merit now being made by Zlinavion at Zlin.

The "KrajaneK" is a conventional, high-wing, single-strutted, intermediate type, of wooden construction, and the special aim of its designers was to produce a strong school or club training machine

the pilot. An open cockpit cover with neat wind-shield is normally fitted, and a plexiglass fully-enclosed cover is also available if required. Behind the pilot's head, in the neck of the fuselage, is a built-in compartment large enough to contain small items of gear in addition to a barograph, access being obtained through a hinged panel to which the pilot's head-cushion is attached.

A neat instrument-panel is provided, permitting



The "KrajaneK,"

with good stability, ease of handling, and simplicity in production and assembly. Reasonable cost, and low weight consistent with ample strength requirements, were further factors taken into account.

The result is an aircraft of sturdy construction, good appearance, fully aerobatic category, and an excellent performance, and the "KrajaneK" is now in production for subsequent issue to the Czechoslovakian clubs and schools.

The fuselage is of sectional construction, plywood covered. The cockpit is roomy, and the seat-design gives a very comfortable and natural position for

installation of all the required instruments, and this panel is flexibly mounted on rubber pads. A hook for bunji launching, and a quick-release for tow-launching (winch or aero-tow) are fitted in the nose. The landing gear is a strong ash skid of conventional design, with rubber shock-absorbers, and the tail-skid is an ash block to which is attached a small fitting used for tail-holding when launching by bunji. The rear end of the fuselage tapers towards a small platform on which the tailplane is mounted, and the whole structure is soundly built and of admirable strength.

The mainplane is centrally divided, each half-wing

THE SAILPLANE

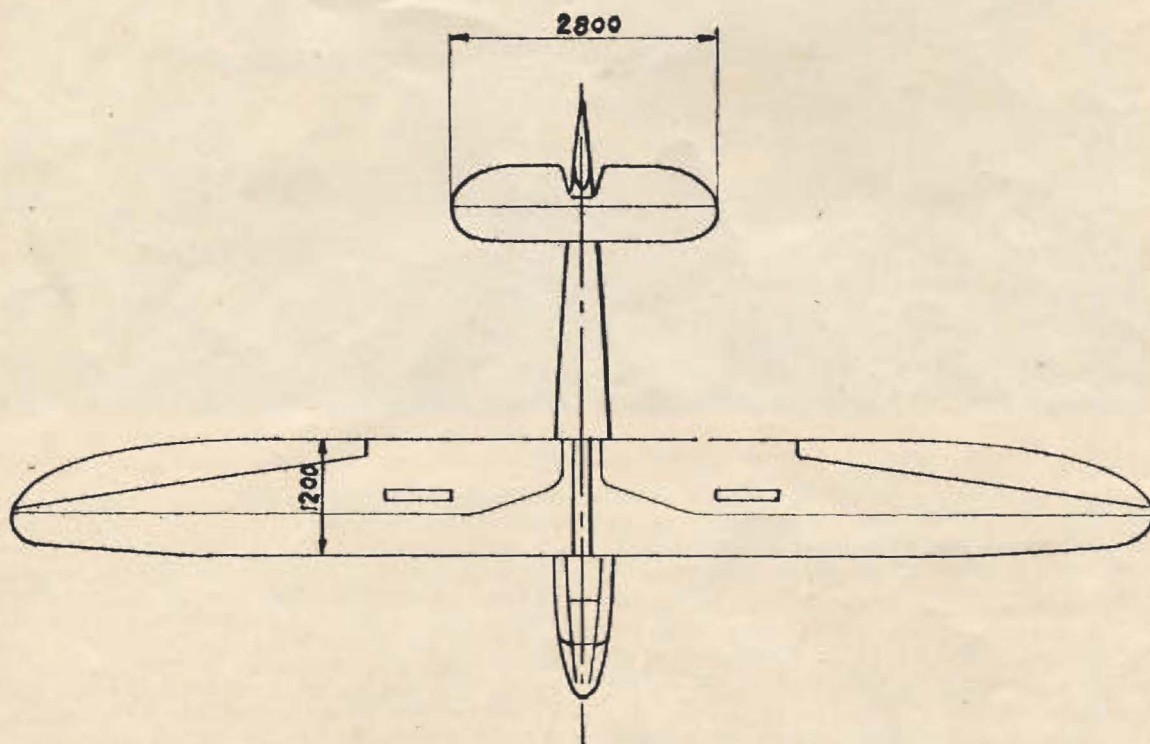
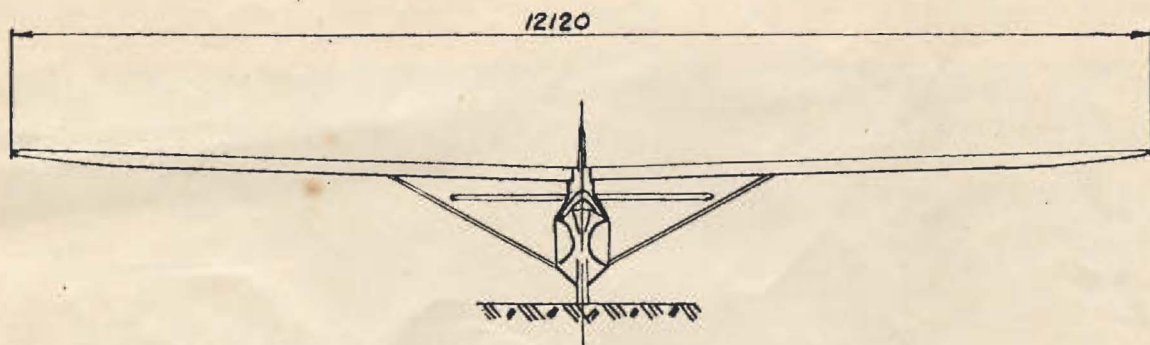
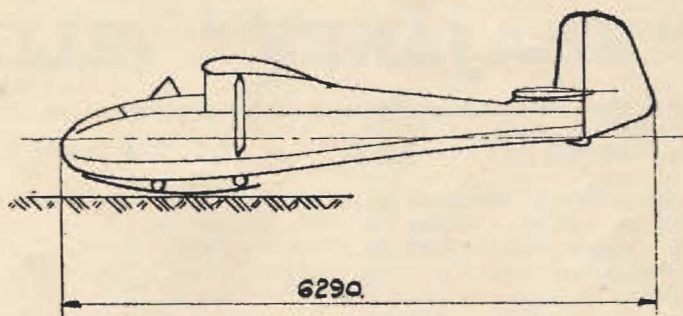

being attached to the fuselage by means of two orthodox metal fittings. It has a deep mainspar, and an auxiliary spar is sited in the rear. The leading edge is diagonally covered with plywood, giving a high degree of strength, and aft of the mainspar, fabric covering is used. The mainplane is fitted with efficient dive-brakes, the surfaces of which, when open, extend above and below the wing, and their action is such that at the start of their travel there is only a very slight change in the rate of sink. The surface-area is so calculated that the aircraft cannot be dived, with brakes in action, at more than the limit-speed estimated in the performance-calculations of the design. They are well balanced and light in operation.

Although the aspect ratio (12) is not high, the plan form of the mainplane is pleasing, and the ailerons are of adequate area, giving good control in flight. Strong construction of the ailerons is obtained by the use of two spars joined with plywood covering, and there is no diagonal bracing. The ailerons are fabric-covered.

The rudder has one spar, and the leading edge is plywood covered forward of the spar; the use of diagonal bracing is again eliminated, with a consequent saving in weight. The elevator is of similar construction. The tailplane is cantilever, with two spars, and is fabric-covered. Attachment to the fuselage is three-point.

The control column is seated in two bearings of a textile rubber compound mounted in sheet metal holders of special design. Control of the ailerons is differential, and is operated by means of push-pull rods, levers, and cables. Rudder control is normal and the pedals are non-adjustable. All controls are well-balanced and light in operation. Snap-opening inspection-panels of circular shape are available at all necessary inspection-points.

A thorough examination of the aircraft confirmed its sturdy construction, ease of flight-assembly and maintenance, and wealth of neat detail. The model under inspection was finished in cream high-gloss cellulose which was said to have excellent weathering qualities. As will be seen from the illustration, the dihedral angle of the main planes is marked, but the aircraft is of good appearance throughout.

Opportunity was given for a flight-test of this sailplane, and the launch was by aero-tow to a height of about 2,500 feet. On tow behind a Zlin-281 monoplane (105-h.p. Thomas IV) at a speed of 100 kilometres (63 miles) per hour, the "Krajanek" was smooth and easy to handle, and required no excessive pressure on the controls in order to keep in position behind the tug.

In free flight after release, the controls were found to be well balanced, fully responsive, yet very stable. The sailplane was quiet in flight, the windscreen was efficient, and the cockpit free from draught. In turns it was found possible to release the stick without causing any appreciable change of attitude, and in level flight the aircraft appeared to fly best at 60 kilometres (37½ miles) per hour, at which speed the rate of sink indicated by the variometer was less than 1 metre per second. The stall was extremely mild;

with the stick well back, and at less than 45 k./hr. indicated airspeed, it was difficult to effect, and recovery was quite smooth and normal.

Aerobatics were practised during the flight, and loops and stall-turns were found easy to perform, the aircraft reacting cleanly to all movements of the controls. Penetration, for a sailplane of this class, was also well above average, a small forward movement of the stick quickly producing extra speed for very little additional loss of height.

The air-brakes, operated by a hand lever on the left-hand side of the cockpit, rendered the approach one of absolute simplicity and safety. Used just like the throttle on a powered aircraft, their application at once produced a smooth and positive effect which enabled the angle of approach to be varied at will.

The full performance of the "Krajanek," from launch to landing, was in fact one of surprising merit, and it was found that the designers' claims were very adequately substantiated in flight. Performance data is appended:—

Dimensions :

Wing span ..	12.12 metres.	39' 4"
Length ..	6.29 "	20' 5"
Height ..	1.55 "	5' 0"

Weights :

Empty weight	125 kgs.	275 lbs.
Useful load ..	90 "	198 "
Gross weight ..	215 "	473 "
Wing loading		3.26 "
per s./m. ..	15.9 ..	

Performance :

Gliding angle ..	1:17½ at 60-km. (37½ m.p.h.).
Sinking speed ..	2.6-fps. at 52-km. (32½ m.p.h.)
Minimum speed	45-km. (28½ m.p.h.).

Sailplane Design Competition

The following corrections to the Requirements for the Sailplane Design Competition—published in the December issue—have been received from the B.G.A., who regret any inconvenience caused.

- (1) *Structure.*
For "2 pilots with parachutes, not less than 311 lbs. (75 kilograms each)" read "not less than 400 lbs."
- (2) *Structure.*
In (a) for "Climax" read "CL max."
- (3) *Structure.*
In (b), for "0.3 4 wing-loading lb./sq. ft." read "0.3 x 4 wing loading lb./sq. ft."
- (4) *Type Record.*
In (e) for "stiffness," read "factors."
- (5) *Type Records.*
Add new sub-section:
(f) *An estimate of wing torsional stiffness.*

TWO INTERESTING PHOTOGRAPHS

during the British Gliding



Orographic cloud forming over the Tatra mountains; these clouds were in the same position over the mountain throughout a gale which swept practically the whole of Europe in September. This apparent phenomenon was caused by the air stream passing through the cloud, condensing at one point and evaporating again shortly after.

DUTCH GLIDING NEWS

THE Gliding movement in Holland, like other countries, suffered seriously during the war years, but we are glad to report that through the enthusiastic efforts of members of the Amsterdam and other clubs, operations have re-commenced and the movement to-day is slowly but painfully gaining ground.

The Amsterdam Club was the first to get going with a Christmas camp at Soesterberg in 1945, using one E.G.S. primary trainer and a launching winch evolved from the remains of a 15-years-old Nash

motor car. A short time later, a "Grunau Baby," which had miraculously escaped the grabbing hands of the Bosch, was added to the strength, and in the summer of '46, the National Aeronautical Research Institute placed their captured "Goevier" ("Göppingen 4") at the Club's disposal. This machine is used by the N.A.R.I. for practical aerodynamic research work, and has been given the appropriate name "Tromp," which was the pseudonym of the Institute's director during his work with the underground movement.

**TAKEN BY JACK RICE AT SVIT,
Delegates' Visit to Czechoslovakia**



The columns are at the entrance to the "Community House" of the Bata organisation where the party was so grandly entertained. The peaks seen are roughly twenty miles from the camera.

H.R.H. Prince Bernhard takes a keen and active interest in all gliding matters and has loaned his own private "Fieseler Storch" for aero-towing the "Tromp" two-seater. This laudable gesture enables instructors from other clubs to obtain useful and prolonged dual instruction, a system which might with advantage be employed here at some central or communal pool.

The Germans have stolen or destroyed all high-performance sailplanes, but the Netherlands Royal Aero Club has instructed the Fokker Works to commence the manufacture of suitable types, and last summer a number of E.G.S. trainers were made

available for those clubs whose equipment had been stolen or destroyed, and it is hoped that next year, other and more efficient types will be on the market.

Ir T. van Oosterom, of the Research Institute, who is also a founder member of the Amsterdam Club, informs me that good thermal conditions prevail at Soesterberg, and that winch launches of over 2,000 ft. are common. This with only 3,000 ft. of cable, but the hook on the "Grunau" has been moved back, nearer the c.g., thus reducing the cable-thrust moment about this point.

G. F. B.



H.R.H. Prince Bernhard of the Netherlands, preparing for a flight in the Goevier "Tromp" at Soesterberg, during the Amsterdam Club's summer camp.

Cellon Adopt Five-Day Week

Cellon Limited, of Kingston-on-Thames, the manufacturers of Cerric and Cerrux Finishes, have adopted the five-day week, and the Cellon Works at Kingston-on-Thames, is accordingly closed on Saturdays.

It will be remembered that Cellon have taken a prominent part in the amelioration of working conditions, in that holidays with full pay have been given to all employees since 1918. In 1934 the minimum holiday was extended to two weeks, and this has been operative ever since.

T H E S A I L P L A N E

BLIND MAN'S BLUFF

By "GRACIAS"

RATHER surprisingly, there does not appear to have been an article on blind flying since "Gamefeather's" in January 1938. But against this astonishing dearth must be set some of the fine accounts of individual climbs, mainly from Philip Wills' lucid and entertaining pen. No-one who is mad enough to want to dabble in B.B.C.* (however mildly) can do better than to re-read some of these. (SAILPLANE, Vol. 9, pages 154 and 216; Vol. 10, page 138; Vol. 14, No. 8, page 19; and No. 9, page 7.)

I do not propose to treat of the actual system of instrument flying in detail, since I am not qualified to do so, and it will be simpler to read it up in a text-book, or get an Air Force friend to explain it to you. These notes are written only for those who were not taught I.F. at the taxpayer's expense but who are, like myself, in the process of learning by trial and error.

There are three requirements for cloud-flying—apart from the cloud itself, of which I treat below.

A sailplane of adequate strength, stability, and handling qualities;

A turn and bank indicator (as well as the other instruments);

A parachute.

And the pilot must know how to use all three.

Assuming that the embryo Dittmar has already learnt how to fly his sailplane, the next thing to do is to put in a number of hours soaring in clear air with the T. and B. running. You will probably find that various snags develop, and that the sensitivity requires adjustment, etc.; and I have not seen the necessity stressed before of getting used to the noise: it is quite extraordinary how different the sailplane sounds with the motor humming. The first exercise is to mark the movements of the turn needle when flying straight, to learn how much needle swing either side of centre indicates how much yaw. Next, put your head inside the cockpit, don't cheat, and try to keep straight on instruments alone.

1. Centralise turn needle with rudder.
2. Correct pitch by reference to A.S.I. and the sound of the airflow.
3. Correct bank needle with ailerons.

The next exercise is to mark the movements of the turn needle while circling, both gentle and tight (10—15 seconds) circles. For heaven's sake, find out at what rate of turn you approximate to 45° bank, and avoid it like the plague for ever afterwards when in cloud. Then, whenever you have sufficient height and a clear field of action, practise circling on instruments; on your first attempt, if you are still in good order after five circles I can only assume that you are cheating—or else flying an "Olympia."

Having eased off the excess speed you will then remember that moving the stick back does not ALWAYS reduce speed, which accounts for the Rate 4 turn with which you finished. Next time we will allow you to look out when the rate of turn and the speed start to go up. You will probably get quite a shock when you see how much your nose is down, and how steep your angle of bank. (Try

easing the stick back now, without applying top rudder, if you are still not convinced!) In rough air in cloud, your rate of turn and speed are always liable to creep up; it is absolutely essential to stop the turn *before* attempting to get the speed down, if you want to avoid trouble. I have found the following sequence the most satisfactory way out of it:—

- Simultaneously
1. Apply top (opposite) rudder to bring the nose up.
 2. Ease the stick forward to reduce the rate of turn.
 3. Apply opposite aileron, to help things along generally.

This seems to work very well with a pre-war "Kite." It has the great advantage that it ought not to leave you in a stalled position, which might well result from easing back the stick at a speed of, say, 60 m.p.h. It will, however, stop your turn and reduce speed up to a point; when the rate of turn is down to $\frac{1}{2}$ or 1, then is the time to reduce speed further with the elevators, and tidy the instruments up generally, according to the text-book.

The next thing to practice is the complete and unquestioned mastery of mind over matter. It is all very well to quote to yourself the text-book, that to straighten out of a right-hand turn feels like starting one to the left, but just you try it and see! If you do not overcome completely your normal—but not better—instincts, you will assuredly end inside a B.B.C.* heartily sick of it all, but with no more idea of flying out of it on a given course than the Chancellor of the Exchequer. The only comfort being that you will probably come out of it sometime, somewhere, D.V. I have purposely put this business of straightening out of turns last because it is the most difficult part; but it contains the kernel of the whole subject: that things are rarely what they feel, and that the Turn and Bank requires a highly inferential interpretation.

Go to it assiduously; and whenever possible do your circles and above all straighten out of turns on instruments alone—without cheating.

We can draw a veil over the next few practice flights, and come to the time when you are seriously thinking about having a sniff inside a small cumulus. The only trouble being that most small cumuli of my acquaintance don't in the least want to have you racketing around in their insides; it is not so easy as it seems to pick a cloud into which you can climb. Another dictum which I found quite fallacious was the idea that beginners should not attempt to circle, but fly straight through clouds; the trouble here being that upcurrents are often just as small, scarce, and weak, inside cloud as out. At any rate, I reached this stage of proficiency just before the war; but it was not until I took my courage in my hands and ventured inside a B.B.C.* last summer that I managed to climb a foot.

Don't pick a Cu-Nb for your first attempt, but on the other hand go to it as if you meant it. The next time you are comfortably settled in a thermal, reduce your turn to rate 1, and carry on into cloud;

on your way up underneath it you should have already made an appreciation of its character, and noted which direction to fly in order to get out of it. Assuming that you retain control, you may well find that after a few hundred feet the upcurrent dies on you: at any rate, that was my experience last year. I think the reason is that one's flying is not nearly so accurate, and one by no means gets the best out of the sailplane; and remember, one flies out of the upcurrent just as in clear air. But the question is, what to do next? As we are by no means Dittmar's yet, I suggest the best thing is to fly up-wind on a compass course; you may get back into the same upcurrent, or you may find another, in which case start to circle again; but you will probably come down through the base of the cloud. Having flown up-wind, you ought to be within range of the club landing ground.

You then throw a couple of loops to celebrate, light a cigarette, and begin to think out what you ought to have done. Ten to one, you'll agree that you've had quite enough for a first attempt.

Even if the cloud was quite smooth, you will probably have found that your speed varied considerably. You will have experienced the vertigo due to circling, and straightening out of circles, and also due to vertical accelerations. Your well-mannered and sober compass will have spun itself giddy in a drunken waltz. But never mind, you have made your first climb inside cumulus.

My own efforts last year were in strong wind conditions at (or from) the Long Mynd, mainly in clouds arranged in streets parallel to the wind. This has a great advantage for the beginner; if you want to come out, fly across-wind; but if you want to search for another upcurrent, fly either up- or down-wind. I never realised before what a small proportion of a cumulus was rising at a usable rate. I soon learnt. Only once did I find a cloud in which it was possible to climb by flying straight through it. I emerged, having flown up-wind, about 1,000 ft. above its base, but when I turned and traversed it down-wind the red ball never showed less than 5 ft./sec. sink, and I came out through its base again—but five miles down-wind of the Long Mynd. That was in a line-squall Cu, arranged across the 30 m.p.h. wind, heavy rain, and while I was in it, its base came down onto the Mynd and stopped flying for the time.

If you want to stay in cloud, don't enter it unless you think you are in the strongest area of lift. I completely spoil one attempt. A winch launch in unsoarable south wind of 15—20 m.p.h. under a cloud-street gave me a long struggle and slow climb to cloud-base. Now that cloud was obviously a beauty, and went up to eight or ten thousand feet, I carried on into cloud where I was, and with some difficulty made another 1,000 ft. to 4,500 ft. a.s.l. Lift was patchy and weak. Sooner or later I blundered out of the side door, saw that I was getting down-wind, and so flew partly in and partly out towards the club ground. I never saw the green ball appear again.

On reaching cloud-base I ought to have searched for stronger lift; Mr. Espin Hardwick found lift of up to 20 ft./sec. under it at the same time. I made the second error on coming out of cloud; I ought

Sailplane Trailers

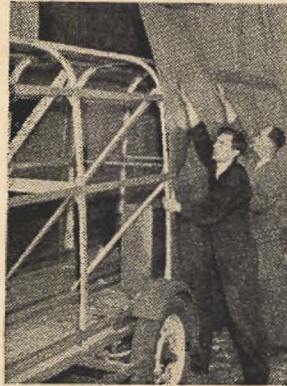
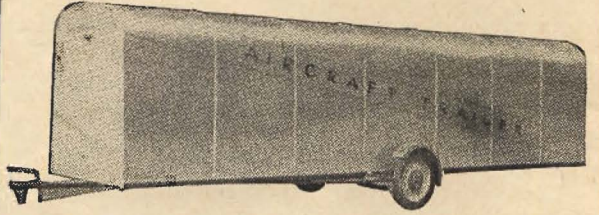

This Trailer is designed and built by practical enthusiasts—arising out of years of experience in the use of Sailplanes in the hills and over the moorlands of the north. Of light weight, it will hangar your Sailplane against wind and weather—it will follow you faithfully and deliver your machine fit to fly wherever you will.

FEATURES

- ★ All-steel welded chassis
- ★ Tubular steel axle
- ★ Wide track
- ★ Long springs
- ★ Maximum spring base
- ★ Easy ride
- ★ Automatic Braking
- ★ Light composite superstructure

TYPE DE LUXE FOR KITE II AND OLYMPIA

£250

(finished polished aluminium)

List of other model trailers and trailer chassis on application to the manufacturers:

KENNING AVIATION Ltd.

Derby Airport, BURNASTON

Telephone:

Etwell 123

PIONEERING

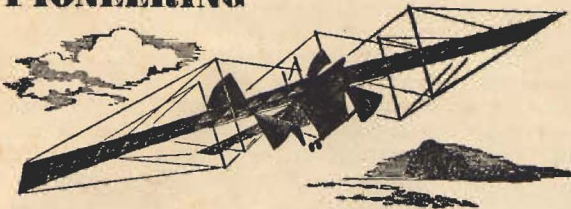

As Henson, whose 25-h.p. steam-propelled aeroplane of 1843 is illustrated above, ranked among those who pioneered aviation, so the makers of Dagenite batteries pioneered the construction of AIRCRAFT ACCUMULATORS. To-day, because they embody the results of a rich experience, Dagenite Batteries are an essential of the most modern aircraft.



Illustrated is the Dagenite Aerobatic Unspillable Battery. Other types for the aircraft itself and for ground starting are supplied.

DAGENITE
AIRCRAFT BATTERIES

PR3B/44

PETO AND RADFORD, 50, GROSVENOR GARDENS, LONDON, S.W.1

Gillette temper blades electrically!

Electrically tempered to take the hardest, sharpest shaving edges. Every edge shaped in three facets forming supporting shoulders for extra strength. You may ignore such technicalities, but not the smoother, more refreshing shaves Gillette blades give you.

2'6 FOR 10
INCL. TAX



**'Good Mornings'
begin with Gillette**

SLINGSBY _____
_____ **SAILPLANES Ltd.**

KIRBYMOORSIDE, YORKS.

PIONEERS IN THE DESIGN AND
MANUFACTURE OF GLIDERS AND
HIGH PERFORMANCE SAILPLANES

Tel.: Kirbymoorside 312.

'Grams: "Sailplanes."

THE BRITISH GLIDING ASSOCIATION ANNOUNCEMENTS

The Association was registered as a Limited Company on October 30th, 1946. The Registration Number is 422605.

New Clubs.

The following have been elected Associate Members of the B.G.A. :—

Imperial College Gliding Club (Sec. : P. J. Royce),
Imperial College, Prince Consort Road, South
Kensington, London, S.W.7.

North Wales Cross-Country Soaring Club (Sec. :
W. E. Crease),
Fairholme, Woodlands Road, Hough Green,
Chester.

Please add to list of members.

Member of Council.

The Council have co-opted Mr. G. A. Hincliffe (Yorkshire Gliding Club) as a member of the Council until the Council is re-constituted at the next General Meeting.

Associate Members' Representation.

The Council have given careful consideration to this matter, and have appointed two of their members to watch the interests of Associate Clubs. The appointments are made geographically so that Associate Clubs in different parts of the country can have easy access to their respective representatives. Mr. Basil Meads was appointed for the northern part of Great Britain, and Mrs. A. C. Douglas for the South :—

- North.* Mr. Basil Meads,
Stoneycroft, London Road, Alderley
Edge, Cheshire.
North Wales Cross-Country Soaring Club.
Fforest Fawr Soaring.
Royal Engineers' Flying Club (Gliding
Section).
Furness Gliding Club.
Scottish Gliding Union.
Ulster Gliding Club.
No. 13 O.T.U. Gliding Club.
- South.* Mrs. A. C. Douglas,
Staplehurst Farm, Salfords, Redhill,
Surrey.
Aerotech Flying Club No. 1.
Channel Gliding Club.
Croydon Gliding Club.
Imperial College Gliding Club.
North Somerset Gliding Club.
R.A.E. Technical College Gliding Club.
Soaring Club of Great Britain.
Standard Telephones and Cables Gliding
Club.

Service Associate Clubs in Germany should correspond direct with the Secretary.

The Council wish to emphasize that all Associate Clubs can bring any matters they wish before the Council or Secretary at any time. Although unable to nominate representatives for the Council until they are full members, Associate Clubs are always

entitled to place their views before the Council, and to speak (but not vote) at General Meetings on any subject.

Associate Clubs are reminded that this type of Membership is primarily intended as a transitional stage to full development and full membership, with a share in the responsibility of the conduct of the affairs of the Association.

R./T. Sets.

After long and protracted negotiations, it has been possible to obtain the release of the R./T. Sets originally required by Clubs. The Midland Club has kindly arranged to collect, pack and dispatch these sets. The Ministry of Civil Aviation has allotted a frequency from the Civil Aviation Band, and the G.P.O. will be issuing an overall licence to the Secretary of the B.G.A. to cover all the sets, for which individual Clubs will be given individual permits. *Until the frequency and permits are received by individual Clubs, the sets must not be operated.* It is hoped to send the desired particulars within a few days.

B.G.A. Research Library.

A start has been made on this library, which will eventually be housed in Londonderry House. A list of publications available is attached. At the moment loans will have to be confined to Research Committee members and individuals engaged on research.

All requests must be addressed direct to the Research Librarian :—

Dr. A. E. Slater,
Dell Farm, Whipsnade, Dunstable, Beds.

B.G.A. Research and Technical Publications (R.T.P.).

Information and reports from the B.G.A. Committees, Clubs and individuals who are doing Research work are now beginning to come in.

One copy of each of these reports produced to date, complete with spring-back binder are available to all Clubs, Council and Committee members for ten shillings. Further reports and an index will follow free of charge to subscribers, as they appear. The cost to subscribers not connected with the B.G.A. and of extra sets will be twenty shillings a year.

The first three reports are as follows :—

- (i) Some notes on aero-towing (produced in response to an unofficial request by the A.R.B.).
- (ii) Handling trials on the H.17 (interim report).
- (iii) Notes on car-towed launching.

Numbers 4, 5 and 6, which cover notes on Turn-and-Bank calibrations, Air Speed Indicators, and an Analysis of soaring flights of 1946, are in course of preparation.

Will those wishing to take advantage of this service please inform the Secretary as soon as possible, remitting cash.

In addition, would those who have information which they consider would provide a useful report, please get in touch with the Honorary Secretary :—

Mrs. A. C. Douglas,
Staplehurst Farm, Salfords, Redhill, Surrey.

Change of Address.

The B.G.A. offices are now at Londonderry House, Park Lane, W.1. The new telephone number will be notified as soon as it is available.

Aero-Towing. "Tiger Moth."

The Technical Committee would be grateful to receive information from pilots who have had trouble free experience of "Tiger Moth" towing. It is required in connection, with the approval of the A.R.B., of aero-towing attachments to "Tiger Moths." It is particularly requested that the number of hours flown ("Tiger Moth"), types of sailplanes towed, and number of releases be given.

Correspondence between B.G.A. Offices and Clubs.

The Council, at its last meeting, confirmed the pre-war practice that correspondence between Clubs and the B.G.A. Offices should normally be carried out between the respective secretaries.

B.G.A. RESEARCH LIBRARY.

Royal Meteorological Society Journal Reprints.

- "Discussion on Soaring Flight" (P. A. Wills, etc.).
Extra copies for sale.
- "The Helm Wind of Crossfell" (G. Manley).
Extra copies for sale—2/6.
- "Some Factors in Micro-Climatology" (D. Brunt).
- "The Temperature Characteristics of Different Classes of Air over the British Isles in Winter" (J. E. Belasco).
- "Daily and Seasonal Changes in the Surface Temperature of Fallow Soil at Rothamstead" (H. L. Penman).
- "Variations in Wind Velocity near the Ground" (N. Carruthers).
- "The Eddy Diffusivity and the Temperature of the Lower Layers of the Atmosphere" (T. G. Cowling and A. White).
- "Discussion on Thunderstorm Problems" (T. E. Allibone, etc.).
- "Report on the Helm Wind Inquiry," April 1889 (W. Marriott) (in Q.J.).

Air Ministry.

- "Relation between Ground Contours, Atmospheric Turbulence, Wind Speed and Direction" (W. R. Morgans), R. & M. 1456 (includes summary of Georgii's work up to 1931).

The following **Geophysical Memoirs** are on order:—

- "A Study of the Vertical Gradient of Temperature in the Atmosphere near the Ground" (N. K. Johnson)
- "Transfer of Heat and Momentum in the Lowest Layers of the Atmosphere" (A. C. Best).
- "An Investigation of the Lapse Rate of Temperature in the Lowest Hundred Metres of the Atmosphere" (N. K. Johnson and G. S. P. Heywood).
- "The Structure of Wind over Level Country" (M. A. Giblett, etc.).
- "A Survey of Air Currents in the Bay of Gibraltar (J. H. Field, etc.).

Books.

- "The Climate of the British Isles" (E. G. Bilham).
- "Handbuch des Segelfliegens" (W. Hirth).
- "Sailplanes" (C. H. Latimer Needham).
- "The Drama of Weather" (Sir Napier Shaw).

Paper.

- "Research and Development at the Jet Propulsion Laboratory, Galcit (in Journal of British Interplan Society, September 1946).

Books Bought.

- "Weather Study" (Brunt).
 - "A Short Course in Elementary Meteorology" (Pick).
 - "Meteorology for Aviators" (Sutcliffe).
 - "Meteorological Glossary."
- H. M. Stationery Office.

Royal Aeronautical Society Reprints (on order).

- 8 Papers by Georgii, Lippisch (2), Buxton, Shentstone, Entwistle, Sir G. Walker, W. Schmidt.
- Abstracts (September 1944), Georgii and Beckert on "Standing Waves."

BLIND MAN'S BUFF—(continued from page 12)

to have flown back into it down-wind, because I could see from its shadow that I was near its up-wind edge.

Strangely enough, the easiest clouds I met were also the biggest; possibly the fact that I was very tired at the time caused me to let Gracias fly herself, with beneficial results. Anyway, we reached 8,000 ft. a.s.l. with no trouble at all, at 10 to 15 ft./sec. climb; and only the fact that the barograph had packed up stopped me from looking for more—and possibly saved me from a fate which is reported not to be so very much worse than death, once you stop struggling.

I hope these notes will be of some use to pilots contemplating the most adventurous and thrilling kind of soaring. The literature on the subject is remarkably scanty, especially with regard to the unsuccessful flights. Be of good courage when you enter cloud; and be neither modest nor ashamed when you land, but tell all that happened to you; and if you did reach 80 m.p.h. in the "Grunau Baby," have a word with the Ground Engineer.

I'm going to have some lessons in Instrument Flying this spring!

* BIG BLACK CUMULUS. If bigger and blacker than usual, the first two initials may be left to the reader's discretion.

Australian Gliding Association

SOUTH AUSTRALIA

Gliding and Soaring Club of South Australia (Adelaide). Holiday Camp at Gawler Airstrip. Alan Killmier, Honorary Secretary of the Club, advises that a camp lasting 9 days is being arranged, commencing from 26th December, 1946. The Airstrip is ideal, there being 2 runways at 90 degrees to each other, and each runway is about 1 mile long, with wind socks and control towers.

NEW SOUTH WALES

Flours Airstrip, 25th August. Thermal Soaring in Red "H.17."

Report by Pilot Harry Ryan. "I was given a hop in the Red "H.17" by Ron Cosstick. Could only get 800 feet altitude on the tow with the A.W.A. tow truck, but felt something as soon as I cut. (There was no variometer fitted.) Hung about at 800 feet for a while, but eventually got to 1,650 feet for a duration of 25 minutes. This is the first decent thermal flight at Flours and it appears as though thermals are plentiful at the right time. We were in a 'high' and wind was S.-S.W. Beaufort Scale Force 3 and somewhat chilly, although the sun was quite warm."

Flours Airstrip, August and September. A.W.A. Gliding Club.

Report from Gil Miles. "While the members were rigging the primary glider (following repairs to skid) I had 6 circuits in the 'Pruffling' and thermal conditions were evident particularly over the centre of the Strip, which is shielded by trees on either side and I was able to get in some practice in circling (longest circuit 2 mins. 45 secs.). After lunch the primary was flown by C. Tamplin, L. McCann and Bob Krick, using a 500 ft. towline. C. Tamplin made his first 180 degree turn from about 300 feet altitude. Details of flights made are as follows:— Primary Glider: 4 hops, 3 flights; total, 7 launchings. 'Pruffling': 7 circuits (600 to 800 feet altitude)."

Red "H.17" Sailplane (N. Wickens) damaged.

As a result of a collision with a fence on landing approach this machine was badly damaged at Flours Airstrip in September. The pilot, Cecil Hughes, was not injured.

The Gliding Club of Broken Hill.

The Club was visited by Leo Dowling, Vice-President of the Gliding Club of Victoria, on 21st and 22nd August.

Cumberland Phoenix Gliding Club.

Repairs to primary glider following damage some months back have not yet been completed.

Several new clubs have been formed, including one at Newcastle and another at Oberon, but as far as is known no actual flying has commenced among them. However, the amount of flying recorded by other clubs is very satisfactory.

No information is available at the moment on the activities of the Tamworth Gliding Club, but it is

presumed that their aircraft is not yet complete. The same applies to the Sydney University Gliding Club, and it is known that the Mercury Gliding Club (Sydney) has been making extensive alterations to their machine, and these are very close to completion. Sydney Metropolitan Gliding Club's "Heron" is expected to be completed in the next few weeks.

WESTERN AUSTRALIA

Perth Gliding Club.

Report from Neville Wynne. "Gliding commenced again after a long spell, on 8th September, at the Caversham Airstrip. The 'Rhon Ranger' primary glider (fitted with new wings and skid) was test flown by H. A. Lucky and Ric New, and found to be nose heavy.



Martin Warner, Australian Record Holder, placing 'chute in "Gull" at Walgrove.

The "Grunau Baby II" sailplane (now owned by Warren Major) was test flown by Arthur Farmer (following re-covering with fabric).

Spins, loops and stall turns were executed and one flight to an altitude of 2,000 feet was made for a duration of 20 minutes.

On 15th September, conditions were not good—the wind being across the Strip and showers of rain also hampered activities.

The primary was circuted by H. A. Luckily (duration 1 minute) and a total of 10 ground skids were given to those on No. 1 Flying List.

Both the primary glider and the "Grunau" are housed at Warren Major's place at Midland Junction and are taken out to the Airstrip by trailer.

A Gliding Camp is being organized and is to be held at the Caversham Airstrip over the Christmas holidays.

Use of Radio by Gliding Clubs.

Gil Miles of the A.W.A. Gliding Club (N.S.W.) has drawn attention to the fact that numbers of Australian Gliding organizations have applied to the Postmaster-General's Department for "Communication Licenses" for using Radio Telephones, and most of the applicants want different frequencies.

He points out that some effort should be made to reach unanimity as to the most practicable and useful frequency suitable for Gliding Club use.

In order to accomplish this he asks that the Australian Gliding Association, ask all those individuals and clubs interested in the matter of Radio Communication to write to the Honorary Secretary, Australian Gliding Association, 28, Princess Street, Footscray, W.11, Victoria; setting out their ideas, opinions and reasons for the frequencies, equipment and requirements they suggest.

Gil Miles states: "Our radio needs are twofold, the first being the local training area, which means two-way phone on the ground and to the machines, up to 2 miles. This is easily covered by a frequency

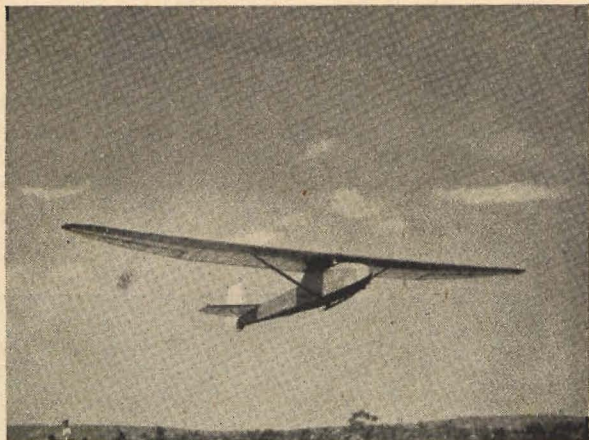

Arthur Farmer's "Grunau" on the tow at Caversham air strip, West Australia.

of about 146 megacycles. The other problem is the cross-country flight and a frequency around 3,250 kilocycles is indicated."

VICTORIA

The Gliding Club of Victoria.

Club Lectures.—The first of a series of lectures on "Construction Work on Gliders" began on Friday evening, 18th October, 1946, at 51, William Street, Melbourne.

MY VISIT TO ELMIRA

By O. P. WINGFIELD

I ARRIVED at Elmira on the morning of October 22nd and rang up the Schweizer Aircraft Corp. In no time Frank Hurtt, Silver "C" pilot and chief instructor and test pilot at Schweizers, was at the station with a car.

We drove out to the Schweizer factory at the County Airport. About the first thing I learned was that it was not necessary to be crazy to be a glider-driver in America, but it was a great help if you were.

At the factory I was introduced to Paul Schweizer. He was just going away for a few days, unfortunately. Ernie Schweizer was also away. However, Frank Hurtt looked after me very well and showed me everything there was to see.

That morning we spent looking around the factory.

Production consists of 2 models: the S.G.U. 1-19 single-place utility, and the S.G.U. 2-22 two-place utility. Neither are intended for high performance, but are machines for beginners, the idea being to get more people interested in gliding and build suitable machines for them to start on. Then they reckon a demand will come later for high-performance sailplanes. Details of them:—

S.G.U. 1-19, single-place utility. Length, 20' 7½", span, 36' 8", weight empty, 320 lbs. Wing—strut braced, wood, fabric covered, with aluminium leading edge. Fuselage—steel tube, fabric covered.

A landing wheel and spoilers are fitted, the cockpit is open. Stalling speed 28 m.p.h., gliding ratio 17.1, sinking speed 3 ft. per second.

S.G.U. 2-22, two-place utility. Length, 25' ½", span, 43', weight empty, 450 lbs. Wing—strut braced, metal, fabric covered with aluminium leading edge. Fuselage—steel tube, fabric covered. Landing wheel and spoilers are fitted, and a cockpit cover. It has a tandem cockpit and can be flown dual or solo. Stalling speed, solo, 28 m.p.h., dual, 31 m.p.h., gliding ratio, 18.1, sinking speed, solo, 2.8 ft. per sec., dual, 3 ft. per sec.

Both are fully aerobatic and fitted for aero-towing.

The steel tube, fabric-covered fuselage does not look as nice as the wooden plywood-covered one, but it looks very rugged and could take a lot of punishment with no more damage than torn fabric.

I also learned of their new high-performance sailplane that is being designed. It seems it will be an all-metal sailplane with aluminium covered fuselage. It will carry water ballast in tanks in the wings, which can be jettisoned. The idea is that this extra weight would increase the speed for cross-country flights. Then later in the day, when thermals weakened, one could jettison the water and reduce the sinking speed at the expense of airspeed. The price of this would be \$2,000 or more.

T H E S A I L P L A N E

When I quoted the price of the Chiltern Olympia, I was told that owing to the high cost of labour it would not be possible to build one in America for less than about \$2,500.

After lunch at the factory cafeteria, Frank Hurtt drove me up to Harris Hill. Being mid-week there was nothing doing, but we went into the hangar and looked around. And what a sight! It was absolutely chock full of 2-seaters, Schweizer S.G. 2-8's, S.G. 2-12's, Laister Kaufman "Yankee Doodles," and Pratt-Raeds.

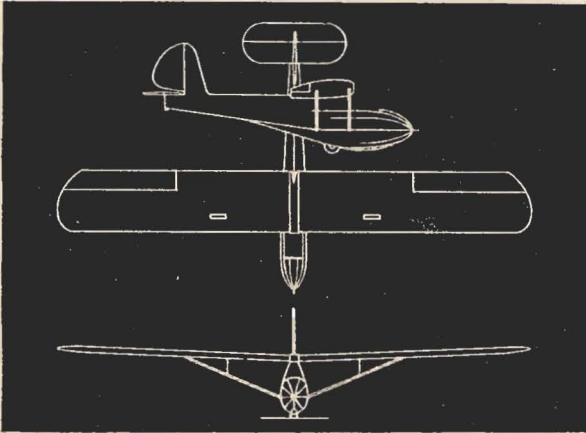

" S G U-1-19.

The S.G. 2-8 is the Schweizer pre-war two-place. The S.G. 2-12 is very similar but was built during the war for the U.S. Army. The Yankee Doodle is fairly similar but not so large, and looks quite useful. The Pratt-Raed is altogether different. It has a side-by-side cockpit, and a tail boom to the tail unit. Apparently there is little difference in performance between them.

It seems the whole lot were surplus, ex-U.S. Army, and that over 300 must have been disposed of at prices from \$400 to \$800. But there are none left to be sold now, the whole lot having been bought by private owners, syndicates, gliding schools, etc.

After looking around there, we drove back to the factory and Frank got out the S.G.U. 2-22 two-place.

We had an aero-tow behind a Fleet up to about 3,200 ft. But there was nothing doing, and we came straight down—not even a down-draught! The machine was pleasant to fly, but had no performance. As they told me, it was designed simply as a utility trainer.

I had quite a good view of Harris Hill. The main ridge is about 500 ft. and has a N.W. slope of about 2 miles. It is all thickly wooded—but clear at the bottom. It was a marvellous sight actually, with all the autumn colours, varying from the bright scarlet of the maples to the dark green of the conifers.

After this flight I had a long chat with Eugene S. Bardwell, public relations and personnel director, in which we exchanged news and views.

Of course the gliding movement in America is on a very different footing to that in England. There

do not seem to be any gliding clubs as we know them. There are private owners or syndicates as in England, gliding schools, and individuals or syndicates "selling glider time" on 2-seaters.

I was told about the new American distance record set up by Dick Johnson and Robert Sparling in a Schweizer S.G. 2-8 on September 8th. From a 1,300 ft. aero-tow at Prescott, Arizona, they flew to Governador, New Mexico, a distance of 314 miles, getting up to 16,000 ft. on the way. This beat the existing 2-seater record of 219 miles, and single-seater record of 290 miles (and approaches the world record of 385 miles).

I recollect that on various occasions in England we have thought how easy it must be to do a really long cross-country in that part of America. But remember there is much more to it than just going up and heading off on a cross-country as we can do in England. Roads are few and far between, and houses and water non-existent for hundreds of miles in some parts. One has to keep to a pre-determined track and make careful preparations. It seems that these two had planned their flight for weeks and carried all sorts of emergency stuff—water, flares, pistol, signalling equipment, etc. Part of their flight took them over the Painted Desert, where a landing would cause them much inconvenience to say the least!

We, in England, may envy the wonderful soaring conditions in the S.W. States of America, but do not consider the other difficulties. In America they envy us in England, where we can fly in any direction and always land within 10 minutes' walk of a house or telephone.

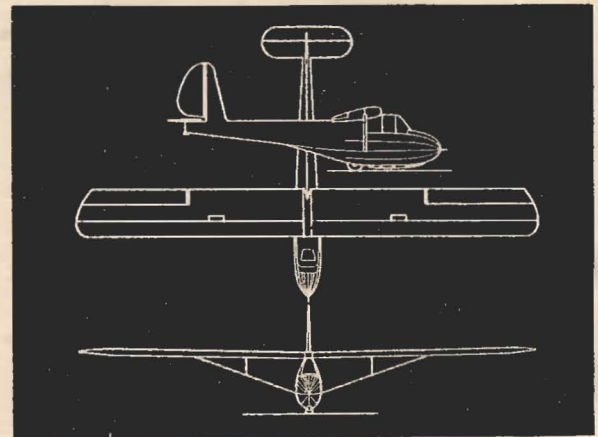

" S G U-2-22."

It seems the idea of International Gliding Competitions is looked on with favour by many American soaring enthusiasts. Quite an interesting discussion developed when I asked how an American sailplane pilot would cope with English conditions and how an English pilot would cope with American conditions.

I cannot conclude this without an expression of appreciation for the hospitality I received at the Schweizer Aircraft Corporation, and for showing me everything there was to see.

11,000 Feet in the Helm Wind

By N. McCLEAN

(Reproduced by permission from "The Newcastle Journal").

THE Helm Wind was blowing strongly down Hartside at mid-day on Thursday. The famous black bar of lenticular cloud was lying at about 8,000 ft. along the ridge with its satellite, the lower bar of cumulus cloud, denoting the turning point of the Helm Wave, at 3,000 ft.

I was launched in the Newcastle Gliding Club's "Grunau Baby" sailplane at 12.40 p.m. from the foot of the Hartside Ridge. The wind was blowing from north-east at about 25 m.p.h., and after casting off the winch cable at 600 ft. I immediately struck lift at 10 ft. per second over the big field from which we were operating.

For a few moments it was pleasant flying. But at 1,000 ft. conditions became really rough. At times the aircraft was momentarily out of control, powerful gusts throwing the machine on to its wing tips. The feeling that the parachute was strapped securely to my back was a comfort!

Like an Express

Suddenly, however, the turmoil died away, and then began the most remarkable period of the flight. I was apparently in smooth air, but the instruments in front of me were performing evolutions which for a time were difficult to believe.

My variometer, which denotes the rate of the aircraft's ascent and which reads up to a lift of 20 ft. per second, was off the scale. The altimeter needle was moving upwards almost with the speed of the second hand of a watch. It became obvious that I was rising like an express lift, at a rate which could scarcely have been far short of 40 ft. per second.

The slopes of Cross Fell slid away rapidly below me; the bar of lower cumulus cloud went by. I remained over the original launching point, rising all the time in this smooth wave of air, wondering what was going to happen next.

At 9,000 ft. the lift suddenly petered out. I should have been level with the lenticular cloud, which had been lying farther out over the valley, but which had now disappeared in the extremely dry air conditions.

Between 9,000 and 9,500 ft. it was a struggle. But then suddenly the lift returned, and once again the green ball of the variometer shot off the top of the scale.

This continued to 11,100 ft., at which height I cruised gently round for about 20 minutes.

At Freezing Point

Through openings in the clouds I could see the coast of North Wales in the south, the hills of Scotland

in the north, and far away in the east through yet another gap, the gleam of the North Sea.

It was extremely cold, and later I discovered that the ink on the barograph needle had frozen. Had I not been carrying a second barograph, which continued to function, there would have been no official record of the flight.

My next problem was how to get down again through the Helm Wave. I tried diving the machine at a steep angle, but with little success. There were moments during successive dives when the instruments actually continued to register a rise. I tried a spin, but failed to hold the machine in this position. Lastly I tried a series of steep side-slips, which at last proved effective. By moving east over the tops of the Pennines I got out of the main lift at 8,000 ft. and managed to come in low over their crests.

Once here it was plain sailing, for a violent draught carried me rapidly down the slopes of the hills to make a landing close to the point of the original take-off.

I had been up for two hours, and in the meantime the wind velocity had increased to over 40 m.p.h. The most anxious moments were perhaps those immediately after landing, for it required a strong crew to hold the machine down until it could be got into the shelter of a wall.

EDITORIAL NOTE.—Mr. McClean and the Newcastle Club are to be congratulated on this new record, more especially as it was no mere piece of luck, but the result of much previous scientific work, in which several club members, and specially Mr. Gordon Manley, co-operated. We have been promised a more detailed and technical account for the next issue.

The stationary air wave is evidently similar to that found in the lee of the Giant Mountains in Silesia, during foehn winds, which has been responsible for most of the more recent world's altitude records. Last February we received a prophetic letter from Dr. Joachim Kuttner, a meteorologist, who himself set up one of these records, in which he wrote:—

"I am convinced that, with the Helm cloud at Cross Fell in winter, you can reach 3,000 metres. . . These specially favourable conditions are found at the Giant Mountains through the combination of two wave systems. You will not find it so good at Cross Fell, since the air temperature distribution in N.E. winds is not the same. Nevertheless you will be astonished that you can far outclimb the 'helm bar,' and that, above a very turbulent layer, absolutely smooth air follows higher up."

(STOP PRESS.—Mr. Wills has just regained the British altitude record with a climb to 14,200 ft. in a cumulo-nimbus cloud at Dunstable.)

(Sailplane, July 1939.)

A PIONEER OF EMPIRE GLIDING

Doctor George A. M. Heydon. New South Wales, Australia

DOCTOR Heydon rendered an outstanding service to Australian Gliding by importing a Slingsby "Gull" Sailplane from England in April, 1939. The "Doc" who is not a young man—he was born in 1881, in Sydney—was a Medical Officer in the Great War, and is now Lecturer on Tropical Diseases at the Public School of Health at the University of Sydney. During the Second World War he was at the constant call of the Defence Authorities on problems arising in tropical war zones.

He learned to fly with the Royal Aero Club of New South Wales in 1933, at an age when the average man would hesitate to learn to drive a car, and became well known as an accomplished interstate flyer in his own Gipsy Moth Aeroplane. He has covered more of Australia by air in a light plane than most Aero Club members, frequently flying over long stretches of difficult country where an engine failure might have meant finis.

I can remember him landing at the Gliding Club of Victoria's slope soaring site at Beveridge in 1935 and damaging the fabric on one wing while taxi-ing under difficult conditions.

The "Doc" is noted for that pre-occupied air of a man of learning, and I have been told that he was somewhat of a trial to his instructors, for his nature is such that he must constantly practice a particular manoeuvre as, say, a cross wind landing or a slow roll until he is quite satisfied that he has attained perfection. He is regarded very highly for his knowledge and skill at instrument flying and during one of his first cross country flights in the "Gull," he tried the kite out in a spin.

The "Doc's" first interest in Gliding came as a result of his association with the late Ken Garden (killed flying bombers over the Atlantic). Ken was one of the gliding enthusiasts of the early 30's and had the use of the Doc's Moth to get time up to qualify for a pilot's licence. Ken used to fly down to Kiama (70 miles South of Sydney) where the Sydney Soaring Club were doing quite a lot of slope soaring with the "Kite I" sailplane. Often the Doc would be with Ken and as a result the Doc got the urge to do some soaring. His first flight in the "Kite I" was on the 5th December, 1937, and he made a nice job of it. Soon after, he commissioned Martin Warner to build the "Kite II."

The Doc was responsible for the first aero towing to be done in Australia—he had an aero tow release fitted to his "Moth" and well over a 100 tows were made at Camden Aerodrome (40 miles from Sydney) alone. In the first "Sailplane Tour" made with the "Gull" during the Easter Holidays, 1940, he flew from Narromine to Condobolin—101 miles, was in the air for 5 hours 12 minutes, having reached 9,200 feet altitude twice—the second climb being made by flying blind in a cloud.

In the more recent "Tour" during the Christmas Holidays, 1945, he made a number of outstanding flights which are recorded fully in the April, 1946, issue of "SAILPLANE & GLIDER."

During the War, his old Gipsy Moth, was "loaned" to the R.A.A.F. and was destroyed by fire when



Doctor G. A. M. Heydon and Sel Owen, with Martin Warner in "Gull", at Walgrove.

another R.A.A.F. aircraft landed on top of it at Mascot Aerodrome, N.S.W. He has since obtained a Tiger Moth, and carried out many aero tows with this plane.

The Doc has not only been a strong supporter of the Sydney Soaring Club, but he has also shown his interest in the Australian Gliding movement generally, by donating £50 to the Australian Gliding Association during 1945, in addition to donations to the N.S.W. Assoc. and Sydney Soaring.

NEWS FROM THE CLUBS

DERBYSHIRE AND LANCASHIRE GLIDING CLUB

The weather during the last three months has been very unkind and our activities on the soaring side have been very limited. A good deal of primary training has been done, however.

On October 26th a party from Messrs. Martin Hearn Ltd. brought their prototype "Kite II" over and some of the more experienced pilots had test flights: expressed themselves well pleased with the penetration and handling qualities of the machine. Those who only watched were struck by the loud moan as the machine passed overhead.

An instructors' meeting was held early in November, when it was decided that in future all *ab initio* training would be done by the bungy squad, and not with a winch until the pupils are proficient hoppers. This decision has been implemented ever since and has made the training a real club function, as everyone has to pull on the ropes. The younger ones keep warm and the older members are reminded of the days when they, too, were shot off into the air to the dizzy height of four feet.

On November 2nd a bonfire party was held at Camphill with a firework display, followed by an excellent supper for about a hundred and fifty people, provided by the lady members, whose efforts on this occasion, as on all others, were beyond praise.

The House Secretary, Stan Armstrong, had organised a well-stocked bar, which also did much to make the evening a great success.

Stan deserves a word of his own; at the beginning of the year he took on the job of House Secretary and has quietly got on with the repairs to the clubhouse and buildings which were in a bad state after seven years of inattention. It is due to his downright hard work in organising and bullying the other members that we now have the finest club facilities in the country. *Nov. 3rd. Wind SSW 5 m.p.h.*

Primary training went on apace and the whole squad had rides. Some other people were winched

into the bottoms of some thin clouds for practice.

December 1st.

After a late start a little weak lift was found on the west slope, but this soon petered out and bungy training started. Later in the day the wind backed to south and two pilots soared the "Kite" over the barrel slope for about half-an-hour each, before dusk put a stop to the proceedings.

December 8th.

The "Dagling" was taken out for about an hour during a bright patch in the fog that enveloped us most of the day, and everyone had a couple of rides. The only excitement was when Mrs. Creese did a hovering act, but both she and the "Dagling" arrived safely if somewhat heavily.

During 1947 it is hoped that we shall run two camps, one at Easter and the other at Whitsuntide, of which more details later. We also hope to be able to get four winches into commission in time for the season.

The Club fleet will be enlarged from eight to thirteen machines, including a two-seater, and this with the private owners will bring the total number of machines based on the site to about twenty.

The committee has written to the B.G.A. expressing the club's willingness to organise a competition meeting. Thus we are looking forward to a very busy year during 1947.

CAMBRIDGE UNIVERSITY GLIDING CLUB.

The Club now flies regularly from Gransden Lodge Aerodrome, although the rather inclement weather in November rather reduced the number of flying days.

Thanks to the kindness of the London Gliding Club one of our "Tutors" was taken to Dunstable early in November, but had to wait nearly 3 weeks before the wind blew in the correct direction. On November 23rd, Boughton and Cochrane obtained their "C's," and to date (Dec. 1st) about 4 hours of soaring have been done.

Flying the other "Tutor" at

Gransden on Nov. 20th, when there was a surface wind of 20—25 m.p.h. and a 1,000 ft. wind of over 30 m.p.h., was a memorable occurrence. Jackson, when flying slowly at the top of the launch, after release found himself going backwards and all pilots experienced vertical descents when into wind above the launching point.

The "Kranich," which has been allocated by the B.G.A. to the Club, is now being repaired, a bill of £150 being anticipated. It is hoped that aero-towing will be available in the spring when the new "Kite" and "Olympia" arrive. Meanwhile the number of members who have done their spots on the "Tutor" steadily rises, and all look forward to real sailplanes and thermals to soar in.

YORKSHIRE GLIDING CLUB

Flying Activity.—The month of October was nearly a wash-out: November, a complete wash-out. Maybe British climate has something to do with the supposed racial tenacity of purpose in the face of odds . . . perhaps on the other hand, the weather is a blessing. If we had too much of the right kind we should have no aircraft left, anyhow! We never saw quite such a November as this one, but in spite of all, someone made a weekly visit, and ensured that Messrs. Damp and Rust didn't have it all their own way.

Oddly enough the first day of December was a hill-soaring day, and we did 5½ hours: the "Kite" was back in the air following repair, and one of those who flew it was J. H. Simpson, who has lived for so long in outlandish foreign parts that he is now able to reside in Northern Yorkshire.

General.—The first post-war dance took place at the Fleece Hotel on November 30th. Organised by Donald Sharpe—the Hon. Treasurer—it was a very successful affair. Quite a number of old faces were missing, but many put in an unexpected appearance—the appearance of some of 'em towards the end of the evening was a little unexpected too, but Sunday morning breakfast wasn't compulsory,

anyhow! It was very fortunate that the next day (Dec. 1st) was the first soaring day for some time, although one or two guests politely declined a passenger trip; having, we suspect, turbulence enough of their own. Incidentally, F./Lt. Aked (A.T.C.) qualified for his "C"—he hails from Blackpool and has done a lot of hard work as an A.T.C. instructor, and learned to glide the hard way.

Future Activity.—It is our policy, in these uncertain days, to avoid talking too much about what we are going to do: it does so often deteriorate into more of "what we'd like to do." However, we can now look forward to a reasonable little fleet of aircraft in the coming year and we can provide soaring facilities for anyone who has experience to the "C" stage, and for power pilots. We cannot risk "Cadet" aircraft on primary training at present, if we are to remain financially sound, pay our way, and give a square deal to members who are qualified, at the moment, only for "Cadet" flying. This applies alike to new trainees, for it would be unfair to accept their subscriptions and insurance contributions, only to leave them all high and dry for an indefinite period, whilst the only training machine went through the repair shop.

It is the intention of this Club to resume a full *ab initio* training plan as soon as it can be done in a proper manner, but how it can be done without some subsidy is difficult to see at this moment. The setting up of the Whitney Straight Committee and Lord Nathan's encouraging words on November 26th, bids us take heart for the future. Many soaring pilots turned the knowledge acquired at their clubs to good account during the war, some with great distinction. This fact has obviously been recognized by the Minister.

It is intended to include in next month's notes an analysis of the flying done this year since we reopened, unless, of course, the activities of the month itself crowd it out—for which one would be indeed thankful! As these notes will appear in early part of January 1947, may we offer to all Gliding enthusiasts, wherever they may be, our very good wishes?

G. A. H.

SHANNON AERO CLUB

The Secretary reports the acquirement of an excellent site near Limerick which—in addition to power flying—should prove ideal for winching.

Visiting pilots express the opinion that the local terrain should be eminently suitable for soaring, and if this opinion is proved correct in practice the Club will proceed to build up a fleet of training and high-performance machines.

SCOTTISH GLIDING UNION

In the period 16th Nov. to 8th Dec., gliding was only possible at Balado Aerodrome on three days, due to bad weather and short daylight, however much good work was crammed into a short time. Until longer daylight hours come in we expect to operate only on each alternate week-end.

"Home work" has been going ahead well. The V.8 Winch which Thorburn is building at Kirkcaldy is reported to be almost completed. This winch is mounted on a two-wheeled trailer and will very much facilitate launching on our soaring site at Bishop Hill. The cable feed mechanism which is being built in is reported to be the last word in this line, and we are all looking forward to better and higher launches. Thorburn is also constructing a steel tube utility trailer to be used for transporting any of our gliders from Balado to Bishop

Hill. The "H.17" which Campbell is building at Dumbarton is also nearing completion and is at present having the control system installed.

On 29th Nov., Campbell gave a lecture on "The Future of Gliding in Scotland" to the MacRobert Reply Association at Greenock, and on 1st Dec., Mr. Russell of the Association paid a visit to Balado.

We would take this opportunity of sending the season's greetings to gliding enthusiasts everywhere and wishing them many happy hours of soaring in 1947.

SURREY GLIDING CLUB

Policy.

Until conditions permit of full training facilities, the Surrey Gliding Club proposes operating for advanced flying purposes only. Pilots must be almost at Silver "C" Standard before being admitted as full flying members.

Only 5 pilots will be admitted as full flying members for each sailplane obtained (8 on two-seaters), and pilots will be permitted to take sailplanes away to other Clubs, or meetings at a daily or weekly rate, so long as each sailplane is booked for the time it is away in 5 names (8 on two-seaters), so that the balance on the remaining machines is not disturbed.

Pilots will be responsible for the care and maintenance of sailplanes when they have them away from the home site, and are expected to

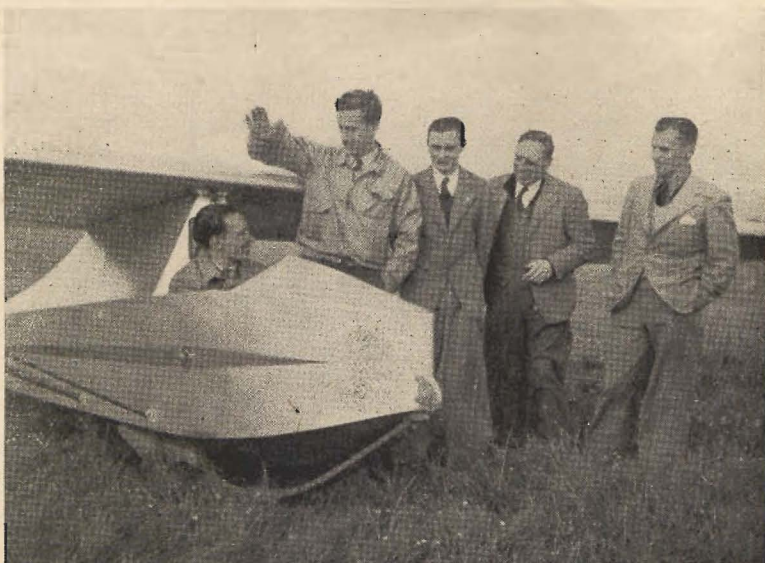

Left to right: Campbell, Thorburn, Whitacre Parker and Lawson, of the Scottish Gliding Union.

look after them in the same way as a private machine.

The aim of the Club is to give members every opportunity of doing cross-country and altitude flying and to develop the technique of team flying in two-seaters, etc., using the latest ideas and equipment as they become available.

SCALE OF CHARGES.

Subscriptions.	£	s.	d.
Full Member—Annual Subscription	21	0	0
" " —Entrance ..	2	2	0
Associate Member (no entrance fee)	2	2	0
Private Owner Member (no entrance fee)	2	2	0
Temporary day Membership (at discretion of C.I.) ..	0	5	0
Private Owner Flying Member	5	5	0
Ditto—Entrance	2	2	0

Flying Fees.

"Weihe"	15/-	an hour.
Sailplanes	8/6	an hour.
Two-Seaters	15/-	an hour.
Trainers	No charge	fixed.

Launching Charges (each).

Winch launch (club aircraft) no charge.	
Winch launch (other aircraft—2/-)	
Aero-towing (max. 2,000')	10/6
(above 2,000')	
for every 500' or part of	
500'	2/6

Liabilities.

Pilot responsible for first £10 of any damage to Club gliders.

Regulations.

1. Every pilot is responsible for the machine he has been flying, and its equipment, until it has been handed over satisfactorily to the next pilot, or to one of the Club officers.

2. Every pilot is responsible for checking that his machine has had a daily inspection, that it contains the proper equipment in good order, and that the barograph has been started before taking off.

3. No pilot may fly any sailplane of a type he has not flown before without a type check by the C.I.

4. A handling flight and report will be completed by each pilot on each sailplane type before he is allowed unrestricted flying on it.

5. Flight reports will be made for any flights where these would serve a useful purpose.

6. When a pilot is airborne he shall be entitled to fly for as long as he can stay up, and shall make every effort to make the best use of the conditions offered, except

when specifically stated otherwise by the Chief Instructor, as in the case of training flights.

NEWCASTLE GLIDING CLUB.

THIS month brings news of a body blow to our training programme from the Admiralty, heavy, but not more than we can weather. After leaving us in doubt as to their intentions regarding Cramlington for a period of many moons, we have now received the glad tidings that they intend to retain the field and all buildings presumably for use as a permanent depot.

Thus smitten, the tribe of Soar (maybe Sore, too!), a little heavy of heart but undaunted, turn elsewhere, roaming far and wide over their native Northumbria in search of pastures new in which to initiate their unskilled brethren in the art of motorless flight. Doubtless before the moon has waxed full a decision on the most suitable new site will have been made and once more the "Dagling" will surge forward on its sometimes uncertain path.

In other branches, the work of 1946 has not been retarded; the foundation and much of the structure of future activities having been satisfactorily completed. The Newcastle house, already a great asset, is proving invaluable as a storage place for material withdrawn from Cramlington. Electric light, ordinary water and heat have been laid on, three rooms nicely decorated and furnished, and the workshops rendered dry and serviceable. All, or nearly all, due to the efforts of members working week-ends and evenings, the industry of the few making up for the absence of the many. Incidentally, a suitable name will be required for the house on completion of repairs. Any ideas? No Roy, not "Hard-work House"!

The latest of the Club Committees to be fully constituted—the Aircraft Committee—is composed of Messrs. Allan, Baker, Little, Dodson and Wilkinson, who under the leadership of Allan have plans for constructional work in hand as well as the normal repair and other work.

The Research Committee, in conjunction with other interested bodies, are going ahead with their plans for studying the Helm Wind and are awaiting the arrival of the

"Olympia." Preliminary scouting has been carried out in the Hartside area and communication arrangements made so that it can be ascertained by telephone from Newcastle whether the Helm is actually blowing at any particular time. The position, regarding soaring sites in this area is good, but as the transport position is poor and the distances from Tyneside fairly great they are washed out as training sites where a high frequency of attendance is desirable.

With a "Dagling" and "Tutor" in hand, an "Olympia" under repair, and a nacelled "Dagling" due here shortly, a "Kite II" on order, and a nacelled "Dagling" and two other machines under construction by members, the aircraft situation holds promise. In fact, though 1947 may dawn a little clouded and hazy, with the efforts of all interested in the promotion of the Gliding Movement in the North-East, and as a whole, it will be a year of achievement.

FOR SALE.

"H-17" used for B.G.A. tests. Machine and Trailer made by Scott Light-Aircraft Co. Instruments and new Glasshouse. Re-varnished to high-class finish. An unique opportunity to secure a fully-tested aircraft with C. of A. Illness of owner sole reason for sale. £200 or near offer.—Box No. 227.

OFFERS are invited for the following:—SCUD III, recently overhauled, complete with instruments and enclosed trailer with interior lighting. KIRBY KITE, damaged but complete. KESTREL, partially constructed, all fittings, bulkheads, ribs, etc., one wing assembled WESTPRUSSEN, cantilever wing in three sections, 52 ft. span.—Further details on application to R. E. Clear, York Cottage, London Road, Purbrook, Hants.

FOR SALE.

ELEMENTARY GLIDING SITE. FREEHOLD AIRFIELD, near Croydon, 49½ acres level pasture with all metal hangar, 7,000 super ft., also eminently suitable for Sports Ground, Building Estate, etc. Auction 15th January next. Plan and particulars from Auctioneers, Bowditch & Grant, 103/5, George Street, Croydon.

LETTERS TO THE EDITOR

DEAR SIR,

Mr. Charles Piper's remarks in November *SAILPLANE*, however complimentary, call for some qualifying remarks from us. His figures for potential club members may or may not be accurate, but any real figures on which could be based say, an estimate of revenue, would have to be more thoroughly sifted and then collated. Anyway, his is an unbiassed opinion based on experience, and consequently one worthy of noting for statistics value.

The Croydon Gliding Club Committee have given the present state of affairs of British Gliding a good deal of consideration with a view to learning just what demand there is for Club gliding at the present time, and more important, what the demand is likely to be at a later date. Upon the results of these deliberations the committee have framed the activities of which Mr. Piper writes so encouragingly.

Let it be understood that the C.G.C., is no different from the other clubs to any degree, except perhaps in policy which, to annul the prevalent rumours that the C.G.C. is pursuing a course not in harmony with the rest of the gliding movement, requires some clarification. Our policy is based on the following conclusions. The present day demand for gliding by the population who would be active enough to participate in it is appallingly infinitesimal. In spite of what the B.G.A. might reiterate to the contrary, you, Mr. Editor, can tell how the circulation of *SAILPLANE* is proof positive that out of say, twenty-five million people who are old enough or young enough to be literate, there is depressingly limited demand for books on motorless flight. Consequently, working on the theory that a little smoke comes from a little fire, the demand for gliding is relative. If the anemia of the movement were caused by illiteracy the remedy would be simple; but the real reason is that the social conditions prevailing are not conducive to the expansion of such a sport as gliding. In truth

gliding has not yet caught on in Britain as a national recreation. Further, it is not due to catch on until the present social conditions undergo vast changes for the better. When the British public snaps out of the dog-racing, football pool era, then we can watch for rapid expansion of gliding in Britain.

Thus to the question of "club-subsidy". Our policy embraces the unlikelihood of a subsidy for at least two years. We hope we are wrong. In any case we are solvent, have three machines, a winch, and a retrieving car. Our mechanical equipment is in an appalling state of exhaustion, but it is working and, in consequence, the club is operating and paying its way. We have had to hazard the Government's point of view, and we consider that with the obsolescence of gliders and gliding as war weapons, and the crying demands for houses, food, and essentials of life, gliding must take a very poor position on the list of financial priorities. With these facts in mind the club committee have shaped their plans accordingly. Until the social reformation (and the consequent subsidy) we have decided to cater for the enthusiast, who is ever present in all communities, and to cater for him to the almost complete eclipse of the bar-room flyer and club hanger-on. We run our club on two principles. We operate a Gliding Club firstly for recreational, and secondly (but of extreme importance to the club and the movement) educational purposes. This brings us to our policy on flying. At the crack of the gun in the post-war race into the air, we, like most of the less illustrious clubs, found that we had to rebuild the fabric of the club completely. Furthermore, we had to do this without cash, and without becoming related to the moneylenders. In short we had to get on and do the work ourselves. At this juncture we found that the only people who came near us were the people who had no experience—or very little—but who were instilled with the obsession of Gliding. They saw the set-up and most of them joined.

At the beginning, the club boasted of pilots who were capable of soaring, and "pilots" who didn't know which end of the machine was which. We had three machines all needing repair. It had to be decided then, which would be operated on first, it being possible to work on only one machine at a time. The club wizards decided to step down. The *ab initio* people have been going through their paces for some time now; and the wizards have been doing the winching, instructing, the pleading, the threatening. This scheme, you will observe, is in direct contrast to the subsidy smitten clubs.

What Mr. Piper saw on his visit to our site was a glimpse into the future. The Croydon Club in this past ten months has planted deep its roots, whilst other clubs have been trying to reap the harvest on a crop that decayed years ago. We believe in a long-term policy, because only with such a policy can there be a future for British Gliding.

Yours etc.,
MIKE CONRY,
Committeeman for Public Relations,
Croydon Gliding Club.

DEAR SIR,

In writing the following I feel sure I am voicing the opinion of a considerable number of people in the gliding world who are interested in the whole of the movement in its entire aspect, and not just in turning up at the week-end to fly.

Your article in the November issue on the B.G.A. delegates' visit to Czechoslovakia is a good example of what I mean.

A photograph is shown in that issue of a shoulder attachment fitted to a "Grunau" for attaining greater height off the winch—an idea which is probably of considerable interest to all.

The close-up is indistinct, giving no idea of how it works, and no mention is made as to whether the fitting is duplicated on the off side of the "Grunau."

Another photograph is of a cable retrieving winch: this also

is indistinct, and no details are given as to how it operates.

What is wanted is fewer photographs of people standing by machines, and a lot more good pictures of all types of equipment showing details and giving explanatory notes as to how they are used. For example: photographs of various winches showing clearly the layout of rollers guillotine and fittings, etc., with notes as to size and length of cable, and heights reached.

In other words, not what people fly and how they fly, but what they see and learn.

Yours etc., G. E. NUNN.

DEAR SIR,

In reply to the letter from M. L. Moore on the subject of the sailplane design competition.

I have set out explanations of the requirements which are causing trouble to some competitors and trust that this will clarify the rules.

(1) 90% of Design Diving Speed (4.5Vs).

Design diving speed is the maximum diving speed assumed for stressing purposes. The specification calls for this speed to be 4.5 times the stalling speed (Vs). The 90% is a factor which in effect limits the terminal velocity to 4.5 x Vs with dive brakes extended.

(2) Proof Factor of 1.

Means that under 1.0 times the design loads the structure shall not suffer measurable permanent distortion and shall be in a completely airworthy condition.

(3) Ultimate Factor 1.5.

Means that the structure shall not fail under a load less than 1.5 times the specified normal design loads.

(4) Forces Natural to the Flight Path f 5W at Cl Max.

If the glider is flying in a steady unaccelerated glide at the stalling speed Vs, the lift forces and turning moments correspond to 1 x W, W being the weight of the aircraft. In an accelerated flight path (e.g., in a loop) CL Max may be reached with greater aerodynamic loads than 1 x W. The stressing case calls for the structure to remain airworthy under 5 times the aerodynamic forces and moments

needed to trim the aircraft at the stall in straight unaccelerated flight.

(5) Gust alleviating factor.

If a sailplane enters a vertical gust the instantaneous change of incidence is given by

$$-1 \frac{W}{V}$$

A $\alpha = \tan \frac{V}{V}$ where W is

the gust velocity. In fact, the gust builds up over finite time and incidence change is reduced by this and also the response of the aircraft to the gust. It is therefore the habit to specify a constant gust velocity together with an alleviating factor depending on the wing loading, which is an empirical method of correcting for the effects mentioned. When wing loading is less than 16 lb/sq. ft., the alleviating factor is 0.3 x (Wing Loading)^{1/4}, or as written in the specification 0.3 x ^{1/4}√ Wing Loading.

Yours etc., WILKINSON.

DEAR SIR,

Recently I received a letter from Wing-Commander N. W. Kearon, a member of the 84 Group Gliding Club, at Salzgitter, in Germany, and the following is an extract from his letter which I thought may be of interest to your readers. (Sorry about the crack at the S. & G., but you asked for it.)

"We are finding 'Standing Wave' conditions nowadays. One of our lads reached 1,400 metres last Sunday over the club house. Last Wednesday week Forbes did 10 hours' duration in a 'Minimoa.' On Sunday week I did 6 hours in a 'Weihe.'

"We are still doing 120 hours per month at Salzgitter, and we have thriving affiliated clubs at Fassburg, Luneburg, Lubeck, Sylt, Quackenbruck and Wunstorf, so I don't know how SAILPLANE AND GLIDER can say 'there are hundreds of sailplanes rotting in Germany.'"

"This 'Standing Wave' business is very interesting. 'Adolf' says they have had 3,800 metres on 'Standing Wave' over the Club House. We are now beginning to learn how to find it."

"Adolf," you may remember, is the ex-Luftwaffe fighter pilot whom we employed to drive the winches. W./Comdr. Kearon's letter is dated 28th November, 1946, which is very interesting when you consider the

present winter activity (or lack of it) in our own clubs.

Yours etc.,

J. C. WARD, S./Ldr.

* We do not necessarily agree with the views of correspondents.—EDITOR

SIR,

With respect to the specification drafted by the Committee of the B.G.A., I should like to know what is meant by some of the expressions used, which are new to me:—

1. 90% of the Design Diving Speed (4.5 Vs).

2. The glider shall have proof and ultimate factors of 1 and 1.5 respectively under aerodynamic forces normal to the flight path of 5W at Climax; and any value between 0 and 4W at a speed of 4.5Vs.

3. The glider shall also have proof and ultimate factors of 1 and 1.5 respectively under up and down gusts normal to the flight path of 65F ft/Sec. E.A.S. encountered when in straight level flight at a speed of 3Vs. F is the alleviating factor to convert the gust to an equivalent sharp-edged gust and can be taken as 0.3 4 wing-loading lb/sq. ft.

An elucidation will be very helpful.

Yours etc., M. L. MOORE.

DEAR SIR,

Having read the letter from Mr. Nunn, I am gratified to know that he is so enthusiastic. He calls for greater detail of the equipment we saw in Czechoslovakia, but I would beg him to bear in mind that the visit was so extensive and hurried that one had little time to concentrate on detail, such as the intricacies of the winch design. However, I can give him some facts about the double shoulder method of attaching the cable. This was fitted on only one machine we saw, and we gathered that it was still in the experimental stage. Our party was not very impressed. I would personally prefer the indelicately styled "belly-hook" for high launching as it involves only point to point to release and does not call for a special cable. The method illustrated employs a "Y" end to the cable with similar fittings on

both sides of the machine. The cable ends have each a crescent shaped hook that passes round a stud about 5/8 inch diameter. If the cable is pulled backwards under the machine the crescent is rotated about the stud and drawn out of the sheath surrounding it. If the pilot releases the stud is withdrawn inwards and the hook falls away. Be it noted that he has to release both sides at once. As the point of attachment is so near the G.G. it is obvious that a very heavy wing-loading could arise if the pilot pulled the machine into an extreme position. Another device under review was "Y" attached respectively to the normal forward point and to the underside of the fuselage below the pilot. The "Y" was formed by a short length of cable attached by the normal releases to these points. In the centre of the cable was a small pulley or runner carrying the main launching cable. When on the ground or in low flight this pulley would be near the front attachment. As the machine gained height the pulley moved backwards until it would be near the rearward attachment. This also gives the pilot the ability to assume a high angle of attack and relieves the nose of the cable loading (which is normally the safety device). Here again two releases have to be made and a nasty snatch could occur if not done almost simultaneously.

The light cable-retrieving winches were interesting and I took photos of three different types. But the principle is the same and I doubt if any reader of the SAILPLANE could construct such a complicated device from a photo. The principle of getting the cable by winch is not likely to be employed in Britain, as here we have vehicles for the job and a petrol supply at less than the Czech price, which is anything up to 12/- per gallon and strictly rationed in pints at that. Here again various methods are used. At one place we pulled the light (retrieving) cable up the field to meet another man coming down with the main cable. This was done by the last pilot to land and the man with the heavy cable just pulled out the slack. The small winch then drew out the main cable to the launching point.

At another place the light cable was permanently attached to the main cable about 10 metres from the glider attachment. In this case (which has already been described in the SAILPLANE as being done in Germany), the light cable goes up with the glider and the extra drag, etc., can hardly increase the height of launch. At the third place the light cable was in the form of an endless loop with a reversible drum. Thus the driver could send up the field that point in the loop where the cable joined its ends and where there was a small sledge whose purpose it was to stop the two cables getting twisted. A man at the main winch would connect the launching cable when it was dropped to the sledge, signal and back would come the endless rope drawing the sledge and heavy cable. This method certainly saves time and much running about, but involves laying out the endless rope with a remote pulley such as an old car wheel, plus a very elaborate winch with reversible gear.

The standard of winching was very good indeed. At no time did I see any bucking. Several of the party remarked on the smoothness. The winch-drivers were in the main paid, permanent employees, and naturally got plenty of practice. Cable 3/16 inch diameter is used.

Except for a casual look around I did not examine any of the winches, but what I did look at were very fine examples with good paying-on gear—rather like the German type which they no doubt are, seeing that the Germans trained there during the war. Mr. Nunn will have plenty of opportunity to use his time and skill on the balloon winches which have just been made available to the gliding clubs by the Ministry of Supply. These have the full power transmission gear with surge drum and large storage drum, which parts were lacking on the A.T.C. winches. I believe that this gear can be re-arranged to use the storage drum at a suitable speed. As the drum has a good paying-on device, fully automatic and effective, the effort will be worth-while. The side bollard used by the A.T.C. as a drum has only one bearing and is hardly a sound

idea. Gliding people will be grateful to somebody getting down to the job and finding the best way to convert these "new" winches. The clubs who have wisely ordered these winches should be getting delivery very soon.

Having spent a solid month telling what "we saw and learnt" in Czechoslovakia I trust the above details will satisfy Mr. Nunn's thirst for detail. If he wants the photos of the three light winches he can have them for 2/- post free.

Yours faithfully,

J. CECIL RICE.

DEAR SIR,

The letter from Mr. C. R. Piper in your November issue contains a number of observations with which I am in entire agreement. I should, however, like to add a few further comments on the subject of primary training by the gliding clubs.

Primary training can, and is being carried on by several other clubs besides the Croydon club, and if the gliding movement is to regain its pre-war vitality, primary training is, in my opinion, an essential part of a club's activities. There are a few clubs who have, as Mr. Piper infers, adopted the attitude that if the Government will not pay there is nothing more to be done in the matter. This is a complete negation of the spirit of the gliding movement, and a sorry let-down for those pioneers of gliding in this country who put in such a tremendous amount of hard and enthusiastic work in the decade or so before the war.

The A.T.C. is doing valuable work in teaching the rudiments of gliding to hundreds of youngsters who could not otherwise afford it, but unfortunately it does not at the same time instil into them what is to my mind one of the finest things about gliding, namely, that to put one man into the air requires many hours of hard work (subsidy or no subsidy) by his fellows. The realisation of the necessity for communal effort, and the ability to regard one's efforts as being for the benefit of gliding as a whole, and not just for the benefit of oneself, is best acquired in the hard school of the club primary squad, where most of us

T H E S A I L P L A N E

did more hard (and enjoyable) work each week-end than in the whole of the preceding week!

One of the leading clubs in the country, the Derbyshire and Lancashire club, realised at the end of the war that if gliding was to be put back on its feet, with or without subsidy, an immense amount of work had to be done, and one of the most important factors would be the training of a new generation in the true traditions of the movement. Accordingly, a decision was taken to concentrate a large part of the club resources on primary training, and in spite of many difficulties, economic and otherwise, the club actually commenced training on the 1st January, 1946, and has been carrying on continuously ever since.

The club has purchased four new training machines in preference to ordering sailplanes, and a further "Dagling" is on order. By the end of the year the training fleet will number six machines, three of them "Daglings", and although most of these are recent acquisitions already over 650 training launches have been made, and a satisfactory number of certificates gained by both young and old *abinitios*.

If all the clubs would put forth proportionate efforts in the same direction I feel sure that we should very soon have a strong and virile movement, full of real enthusiasts, who would be genuine assets to the clubs and more valuable than any subsidy.

After all, the post-war super sailplanes that so many are waiting for, still seem nearly as far away as ever, and how can we better employ our time whilst waiting for them than in introducing others to the exhilarating pleasures and good fellowship of gliding.

Finally, a word in support of Mr. J. W. S. Pringle's letter also in your November issue. Mr. Pringle indicates very clearly what is the matter with the gliding movement to-day and I hope that many of those whom he aptly terms the "lazy and ineffectual enthusiasts" will read and digest his remarks.

To put the whole matter in a nutshell, the Government (be it right or left) helps those who first help themselves.

Yours etc., J.S. ARMSTRONG.

ROYAL AERO CLUB GLIDING CERTIFICATES

"A" CERTIFICATES: 237

"B" CERTIFICATES: 76

No.	Name	A.T.C. School or Gliding Club	Date taken
1282	Micheal Quentin Sharp	Derby and Lancs. G.C.	13.10.46
1808	Albert Westbrook	143 G.S., Kenley	19.10.46
2071	Kenneth Walter O'Riley	148 G.S., Southend	11. 8.46
2151	Harry Roy Holloway	81 E.G.S., Yeovil	11. 8.46
2307	Alan Frank Griggs	148 G.S., Southend	27. 9.46
2582	Michael Warry Hillyer	81 E.G.S., Yeovil	18. 8.46
2651	Claude Leslie Grimwood	166 G.S., Hawkinge	21. 7.46
3669	Brian Dudley Jackson	148 G.S., Southend	6.10.46
3725	Peter John Robert Reading	C.126 E.G.S., Booker	13.10.46
3816	Albert Sutcliffe	182 E.G.S., Salmesbury	8. 9.46
4083	David Walter Tanner	C.126 G.S., Booker	8. 9.46
4393	Dennis Lennard Coate	144 G.S., Heston	20.10.46
4422	Norman Black	189 G.C., Carlisle	20.10.46
4941	Peter Henderson Thickett Green	107 G.S., Coleby Grange	20.10.46
4966	George Rea	186 G.S., Speke	3.11.46
5265	Richard Charles Oldfield	Cambridge University	20.10.46
6345	William George Cutting	145 G.S., Boxted	27.10.46
5455	Leslie Richard Stepany	161 G.S., Ford	13.10.46
5513	Robert Andrew Fraser Shields	84 Group G.C., Gitter/Harz	26.10.46
5529	Hugh Barriemore Ollerearnshaw	95 G.S., St. Eval	3.11.46
5635	John Harold Godwin Mitchell	84 Group G.C., Gitter/Harz	28.10.46
5593	Ronald Arthur Hurst	48 G.S., Castle Bromwich	10.11.46
5694	Aubrey Dillon Hill	49 E.G.S., Wyneswoold	13.10.46
5720	Harold Edward Purchase	122 G.S., Harrow	25. 7.43
5728	John Morris Haddock	2 Group G.C.	15.11.45
5733	Roger Frank Pollard	104 G.S., Ipswich	6.10.46
5748	Anthony Basil George Heathcote	23 G.S., Yeaton	18. 8.46
5756	Joseph Howard Frank	4th Arm'd B'de	12. 9.46
5762	Derek Bollworthy	Derby and Lancs. G.C.	13.10.46
5763	James Dunsmuir Boyd	Air Div. G.C.	17. 7.46
5764	Herman Zweers	Ditto	18. 5.46
5765	Nicholas Willink	B.A.F.O. G.C.	20. 7.46
5771	Edward William Thomas	87 G.S., Weston	25. 5.46
5774	George Cecil Fiddler	Newcastle G.C.	19.10.46
5775	Vincent Samuel Pollard	H.Q. 85 Wing	20. 7.46
5781	Lyndon George McFarlane	Bristol G.C.	27. 9.46
5786	Frederick Charles Walker	161 G.S., Ford	10.11.46
5805	Gordon Douglass Mills	84 Group G.C.	1. 6.46
5825	Jozef Jan Maria De Cock	Ditto	18.10.46
5827	Ian Bourne	B.A.F.O. G.C.	20. 4.46
5828	Juzysz Maczka	84 Group G.C.	16. 9.46
5829	Georges Tricot	Ditto	19.10.46
5830	Robert Ian Walton	Ditto	2.10.46
5831	Albert Arthur James Simmonds	Ditto	17. 9.46
5832	Johannes Joelle	Ditto	11.10.46
5833	Ernest Peter Sutton	Ditto	13.10.46
5834	Jacyné Stanislaw	Ditto	27. 9.46
5835	Anthony David Mattock	25 G.S., Hedon	24. 9.46
5846	Douglas John Matthew Meikle	25 G.S., Hedon	18. 8.46
5860	Robin Wells West	84 Group G.C.	23. 6.46
5866	Kenneth Dell Neame	Ditto	15.10.46
5867	Kenneth Lionel Wiseman	Ditto	19.10.46
5868	Ozeswaw Jedrrowiar	Ditto	16. 5.46
5869	William Alfred Stuff	Ditto	16.10.46
5870	John Cecil Avcough	Ditto	16.10.46
5871	Maurice Ovington Bell	Ditto	19.10.46
5872	Eric Raymond Born	Ditto	27. 8.46
5873	Ealce Jan Willam Schuller	2 Group G.C.	15.10.46
5875	Edward Tindall Symonds	192 G.S.	7. 7.40
5877	Harry Stewart Bailey	Ditto	28. 8.46
5878	George Francis Williams	Ditto	14. 4.46
5879	Frank Anderson Rogers	Ditto	9. 3.46
5894	Robert Jack Smallbone	London G.C.	11. 8.46
5896	Arthur Cleaver	Ditto	30.10.46
5902	Reginald Neep	Lubeck G.C.	13.10.46
5906	Michael Darrell Blake	89 G.S., Christchurch
5921	Edward Hamby Andrews	151 R.U. (A).	8. 9.46
5922	Gerald Hammond	Ditto	24. 8.46
5923	Ivor Edwin Stretch	Ditto	18. 8.46
5924	Stanley Harold Clarke	Ditto	2.10.46
5925	Peter Rogers	Ditto	11. 8.46
5930	Wawrzyniec Jan Zapnik	Replacement for Polish Certificate lost during the War	August 1936
5940	John Edward Bristow	161 G.S., Brighton	10.11.46
5947	John Talfryn Evans	48 G.S., Bretford	10.11.46
5948	George William Alan Constable	161 G.S., Brighton	10.11.46
5949	Arthur Cropp	107 G.S., Coleby Grange	13.10.46

"C" CERTIFICATES: 20

(Continued on page 28)

SOARING

Your Emblem

Have you earned a gliding or soaring certificate? Then you have something which very few people in the country, and even in the world, possess.



The A GLIDING BADGE



The B GLIDING BADGE



The C SOARING BADGE



Silver C and Golden C

SOARING BADGES

The A, B, C, Silver C and Golden C badge you received is different from the usual emblem you see people wearing. In most cases the buttons in people's lapels signify that their subscriptions are paid up. In your case it means more than payment of dues. It means you've done something. It means that, without a motor, you are striving to outdo the flight of birds. Wear your badge—and wear it proudly!

TECHNICAIR LTD.

Sailplane Bureau.

Technical and Plans Service.
Chilton Olympia Agents.
— Trailers —

TECHNICAIR LTD.

Aeronautical Engineers
46 NORTH HYDE LANE,
HESTON, MIDDLESEX.

SOUTHALL 1870 ELGAR 5197

COMET MODELS LTD.

FOR

ALL TYPES OF MODEL AIRCRAFT

We Specialise

in the Building of accurate Scale Models of well-known British & Continental Sailplanes Models Built to Customers' Specification.

62 Leam Ter., Leamington Spa, Warwickshire

FOYLES

FOR BOOKS

New & secondhand books on every subject. Books bought.

119-125 CHARING CROSS ROAD LONDON WC 2

Gerrard 5660(16 lines)* Open 9-6 (inc Sat)

THE AERONAUTICAL BOOKSHOP

2 mins. from Oxford Circus. Visit this specialist shop that stocks nothing but Aeronautical Books covering every aspect of Aeronautics. If unable to call send 7d. in stamps for 42 Page Book List and Synopsis of over 500 Aeronautical Publications. — 7, HANOVER COURT, HANOVER STREET, LONDON, W.1. Tel.: MAYfair 4445.

AIRCRAFT (HEREFORD) Ltd.

20/21 Newmarket Street,

HEREFORD,

are Agents for Slingsby Sailplanes. Immediate delivery of "Cadet" and "Tutor." "Kite II's" early 1947.

ROYAL AERO CLUB GLIDING CERTIFICATES—(Continued from page 27)

No.	Name	A.T.C. School or Gliding Club	Date taken
5720	Harold Edward Purchase	122 G.S., Harrow	4.10.46
5728	John Morris Haddock	2 Group G.C.	20.11.46
5763	James Dunsmuir Boyd	Air Div. G.C.	12.11.46
5764	Herman Zweers	Ditto	14. 8.46
5765	Nicholas Willink	B.A.F.O. G.C.	7. 9.46
5775	Vincent Samuel Pollard	H.Q. 85 Wing	28. 7.40
5827	Ian Bourne	B.A.F.O. G.C.	8. 5.46
5830	Robert Ian Walton	84 Group G.C.	10.10.46
5832	Johannes Joelle	Ditto	28.10.46

SILVER BADGES: 2

R. H. Hamlin	(Cert. No. 3991)
J. C. Ward	(4131)

CLUB ANNOUNCEMENTS

THE MIDLAND GLIDING CLUB LIMITED

The Long Mynd, Church Stretton, Shropshire. Telephone: Linley 206.

Full particulars may be obtained from the Secretary, F. G. Batty, F.C.A. 2, Lombard Street West, West Bromwich, Staffs.

THE YORKSHIRE GLIDING CLUB. SUTTON BANK, YORKSHIRE.

Full Flying facilities are offered to all Soaring and Power Pilots.

JOIN NOW and know Gliding at its BEST at Sutton Bank, Yorkshire.

For full particulars apply to: L. A. ALDERSON, "LYNDHURST," SINNINGTON, YORK. Hon. Secretary, Yorkshire Gliding Club.

KENT GLIDING CLUB.

Will all ex-members and others interested and living in the Maidstone or Chatham area, contact the Secretary:

MRS. R. H. HADDOCK, "LENHURST," HARRIETSHAM, KENT.

DERBYSHIRE & LANCASHIRE GLIDING CLUB,

GREAT HUCKLOW, TIDESWELL, Phone Tideswell 207 DERBYSHIRE

To people living in the North Midlands the Club offers full soaring facilities at 10/- per hour in the club fleet of Sailplanes.

Primary training has started and power conversions are a speciality.

The clubhouse is fully licenced and meals are available if booked in advance. Whether there is flying or not there is always something doing every week end.

Subscription, 6 gns.; Entrance fee, 2 gns.; Non-flying members, 1 gn. If you are interested please write to the Hon. Secretary, 87, Fargate, Sheffield 1, for further details.



THE LONDON LINK TRAINER CENTRE

CENTRAL NAVIGATION SCHOOL

*Expert instruction on
latest type Trainers*

*Day Classes for 1st CLASS NAVIGATOR ★
2nd CLASS NAVIGATOR ★ "B" LICENCE*

*Specially designed complete
courses to meet all*

*Spare time tuition in "Study as you work."
Courses for 1st N. Combined Link and*

requirements

Navigation Course for "A" Licence Pilot-Navigators

★ Write for prospectus of all courses.



★Accommodation in London arranged to suit individual needs.

STRAIGHT AVIATION TRAINING LIMITED

BUSH HOUSE · ALDWYCH · LONDON · TELEPHONE TEMPLE BAR 6828



PORTSMOUTH AVIATION LIMITED are agents and
repairers for **SLINGSBY SAILPLANES AND GLIDERS,**

In the Hampshire, Wiltshire, Berkshire, Surrey, Sussex and Kent areas.

They are and have been both before and during the war official Air Ministry
Glider repairers and have years of experience of Kirby Cadet repairs.

Clubs and private owners are invited to avail themselves of the special Sales
and after Sales service.

All enquiries to—

SAILPLANE AND GLIDER DIVISION

PORTSMOUTH AVIATION LTD., THE AIRPORT, PORTSMOUTH.

Telephone: Portsmouth 74374.

Slingsby Sailplanes and Gliders

Production and delivery is so far advanced that no Club or Individual need be without a machine.

The improved Kirby Cadet and Tutor are available for immediate delivery and the Kirby Kite II, already demonstrated to some of the leading Clubs in the country, will be delivered in the near future. Details of a new two-seater will shortly be available and the final range will include a machine to cover every phase of the Sport.

These all-British machines, built to the true Slingsby tradition, are without equal, and you are invited to write for our Handbook containing full data and G. A. drawings.

Official Agents have been appointed to cover every district, and through them you may obtain immediate Delivery, Service and Spares.



THE KIRBY KITE II.

Trial Flights

Any prospective purchaser with the necessary qualifications, may have a trial flight before purchase.

Details on request.

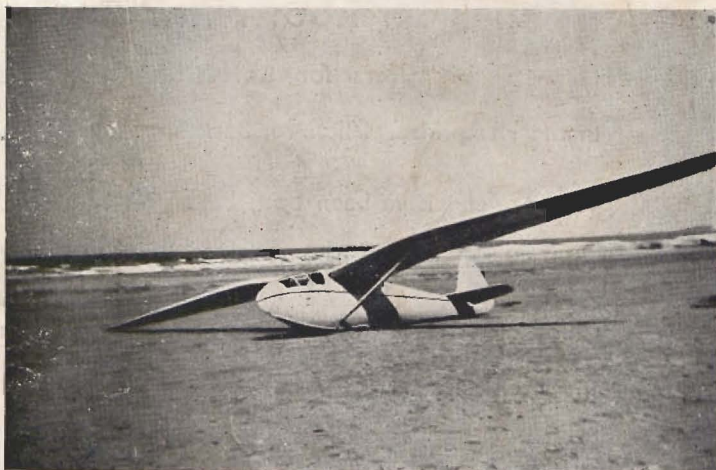

Manufacturers & World agents for all Slingsby Civil Types

All enquiries to:---

MARTIN HEARN Ltd., 72 Victoria St., London S.W.1

Phone VICTORIA 9822 (extension 5).