

# Sailplane & Gliding



## Looking back

– 75 years of British gliding

**AIRBORNE IN THE USA**

Transponders – a European view

April – May 2004

£3.85 Vol. 55 No. 2



# McClean Aviation

[www.mcclean-aviation.com](http://www.mcclean-aviation.com)

**Sole UK and Eire agents  
for DG Flugzeugbau and  
AMS Flight**

**Full repair and  
maintenance  
facility for  
composite structures,  
modifications,  
C of A renewals**

**Member of the  
Guild of Master Craftsmen**

## McClean Aviation

The Aerodrome

Rufforth

York YO 23 3NA

Tel: 01904 738653

Fax: 01904 738146

Email: [mccleanav@supanet.com](mailto:mccleanav@supanet.com)



[www.dgflugzeugbau.de](http://www.dgflugzeugbau.de)



[www.ams-flight.si](http://www.ams-flight.si)

McClean Aviation



The magazine of the  
**British Gliding Association**

April ~ May 2004  
Volume 55 No 2

**Editor: Helen Evans**

7 Ollney Road, Minchinhampton,  
Stroud, Gloucestershire, GL6 9BX

tel: 01453 889580

email: [editor@sailplaneandgliding.co.uk](mailto:editor@sailplaneandgliding.co.uk)

For the BGA office, please use the number below

### Deadlines

June ~ July 2004	
Articles, Letters, Club News	April 13
Display advertisements	April 23
Classifieds	May 5

August ~ September 2004	
Articles, Letters, Club News	June 15
Display advertisements	June 25
Classifieds	July 5

### Publisher

British Gliding Association  
(email: [bga@gliding.co.uk](mailto:bga@gliding.co.uk))

**Advertising in S&G:** Debbie Carr  
(email: [debbie@gliding.co.uk](mailto:debbie@gliding.co.uk))

**Subscribing to S&G:** Beverley Russell  
(email: [beverley@gliding.co.uk](mailto:beverley@gliding.co.uk))

Kimberley House, Vaughan Way  
LEICESTER LE1 4SE  
tel: 0116 253 1051 fax: 0116 251 5939  
[www.gliding.co.uk](http://www.gliding.co.uk)

© British Gliding Association 2004  
All rights reserved. Views expressed herein are not necessarily those of the Association or the Editor

**S&G annual sub:** still just £22.00 in UK  
US \$55 for airmail; \$35 for surface mail



This image was the outcome of great teamwork: many thanks to Pete Masson, Graham Garnett (for supplying the Surrey & Hants Discuses), tug pilots Sam Wallace and Hugh Browning and, it goes without saying, [www.whiteplanes.com](http://www.whiteplanes.com). For our backwards glance at British gliding history, see pp 16-20

# Sailplane & Gliding

## 16 How it happened



Our series marking the British Gliding Association's 75th anniversary year begins with founder **Dougie Culver's** account of how it all began

## 18 The solo way to learn



**Jochen Ewald** takes to the air in a Hungarian-built replica of a Zögling – the first glider type that the newly-formed BGA owned – and finds out what those early pioneers were made of

## 20 Good or bad?



**Francois van Haaff** of the European Gliding Union gives a simple, Europe-wide view of the pros and cons of transponders

## 28 The way home



**Guy Westgate** and Paul Barker are on the last, 2,500km leg of their epic out-and-return, heading back to the gentle South Downs of England after visiting Mt Etna in Sicily

## 38 Airborne in the USA



**Chris Ellis, Richard Starey** and **Graham Turner** share travellers' tales of soaring flight in Arizona, California and Nevada

4 75 years – and 33 years

5 BGA News

8 Your letters

Mike Fairman; Jack Harrison;  
Don Rhodes; Mike Terry; Anon (reply  
by *Anonymous CFI*); Dawn Goldsmith;  
Sam St Pierre; Alan Self; Norman A Jull;  
Tim Barr-Smith; Ralph Jones

12 BGA Development News

12 BGA Technical News

13 BGA Communications News

15 News

24 *Tailfeathers* by Platypus

26 AGM: BGA in a changing world

33 BGA Club Map and Directory

42 Airspace update

46 *Gliding Gallery*

52 Annual Statistics – corrected

54 *Club Focus: London*

55 *Club News*

61 Obituaries

62 BGA Badges

63 Accident/incident summaries

65 Classified advertisements

66 Index to advertisers



Member of the  
**Royal Aero Club**  
and the  
**Fédération Aéronautique Internationale**



# 75 years – and 33 years

**T**HIS year is the 75th anniversary of the BGA's formation at a lunch held in London. After its somewhat turbulent first few years, the BGA was re-established in 1946 with the constitution that continues to serve its original purpose. For over half that time since 1946 one person has been at the centre of the BGA.

This last year has been Barry Rolfe's final full year with the BGA as Secretary. Barry retires on May 8, 2004. He will have served the BGA for over 33 years, nearly all that time as Secretary. During his tenure he has seen many changes, and built up a huge encyclopaedic knowledge of gliding, despite not being a pilot himself. He has worked for eight BGA Chairmen and hundreds of Executive committee members, and somehow managed to keep his cool throughout.

Barry has "the patience of Job" and in my four years as Chairman working with him he has kept the ship on a steady course, always unflappable in a crisis and constructive in criticism when the Executive, or others, has developed a penchant for something that he knows "will not fly."

Barry has also been Secretary of the Royal Aero Club of the United Kingdom, and served that organisation with the same diligence and professionalism with which he has served the BGA. He was recognised for his work some years ago with the Royal Aero Club Bronze Medal, and in 2002 was awarded the highly prestigious Bill Ivans Gold Medal by the Soaring Society of America. At the Royal Aero Club annual awards function on March 9 he was awarded the FAI's Paul Tissandier Diploma.

We paid tribute to Barry's work at the BGA AGM on March 6, with many clubs represented there conveying to Barry their appreciation of all that he has achieved during his long career with us. Extensive coverage of Barry's career will appear in the next issue of S&G.

Many of the more mature generation of glider pilots who like myself started gliding before 1970, and quite a few of the younger ones, see Barry as synonymous with the BGA. He has been the person at the end of the phone who has provided advice on a wide range of topics and issues, to the person signing the letters, sorting out the problems and the difficult issues.

We hope he has had a satisfying career with the BGA and will be able to look back in retirement and feel proud of what he has achieved in creating and sustaining a unique organisation – a template for responsible and successful sports governance.

I take this opportunity, through the medium of S&G, and on behalf of the whole gliding movement, to convey to Barry and



*BGA Vice-President Chris Simpson (right) was invited to pay tribute to Barry Rolfe (left) at the Association's AGM this year. Chris Simpson was one of the first BGA chairmen under whom Barry has served (see also p5 and p26)*

Jenny our sincere and very best wishes for a long and happy retirement.

## **New BGA Chief Executive**

In September we advertised a new role of Chief Executive of the BGA, to take over from Barry. A selection group from the BGA Executive interviewed shortlisted applicants from a quality field. As announced at the AGM on March 6, we have appointed Pete Stratten, who will be known to many readers as someone deeply involved in many aspects of gliding and based at Bicester. Pete takes up his role in May and will be working alongside Barry prior to that to achieve a smooth handover. We wish Pete every success in his new role, and I am sure the gliding movement will support Pete as he gets his feet under the desk that has for so long been Barry's domain.

## **European Aviation Safety Agency**

One of the major challenges facing the British Gliding Association is adaptation to the new regulatory environment created by the formation of the European Aviation Safety Agency (EASA). The role of the BGA is about to undergo probably the most significant change since its formation. The new regulations are EU law, with which the UK complies. We have been heavily engaged in negotiations over recent months with the UK Department for Transport (responsible for aviation regulatory matters) and the CAA. These negotiations deal initially with airworthiness regulations and

whilst the negotiations continue at the time of going to press, nevertheless the forward view is becoming clear.

Space is insufficient to spell out the implications here. Suffice to say, all clubs, pilots, glider owners, inspectors, glider maintenance organisations and the gliding community at large should read the advice that the BGA publishes on this important topic.

It will affect almost everyone and will be made available through all the available communication channels.

**David Roberts**  
Chairman, British Gliding Association  
[d.g.roberts@lineone.net](mailto:d.g.roberts@lineone.net)



# Camphill in 1934, 1954 and 2004

**I**N 1954, a World Gliding Championship was held in the UK for the first time. This was also the first, and certainly the last, to be held at Camphill, the home of the Derbyshire & Lancashire GC.

2004 is both the 50th anniversary of that event, and also the 70th anniversary of the club's formation, so there are two good reasons to celebrate: an international event, and a local example of gliding survival.

The Camphill Rally for vintage and classic gliders is of course well established and one of the world's most popular vintage events. It is fitting, therefore, to make this year's rally, Saturday, June 26 to Sunday, July 5, a "special" celebrating both anniversaries.

Now all we require is an airfield full of old gliders, preferably with pilots.

On the first Sunday – during National Gliding Week – a public Open Day will be held to publicise gliding, the club, and vintage/classic flying, not necessarily in that order. This will not impinge on the rally and we will keep visitors and fingers sticky with ice cream off the airfield and the camping

area. We may ask you, however, to park any gliders not flying where they can be seen. If you make a display board for them then our cup of happiness will, like rain gauges in 1954, be full to overflowing.

On Saturday July 4, a serious event will take place. During the World Championships there was a fatal gliding accident involving an Austrian pilot, and a memorial was later erected at the scene. A ceremony will take place in the morning at the memorial restored on the site, attended by the pilot's widow and members of his club, along with rally pilots and our club members.

There will, or should be, a photo display together with any memorabilia that we can collect or borrow, so if you have anything please send us copies.

The day will end, and the next one begin, in the hangar, where a band, who can – we hope – play 1930s, 1950s and, God help us, 2004 music will get us dancing to give us an appetite for the buffet, and a thirst for the bar.

Ian Dunkley

## From the last Exec

AMONG items considered at the March BGA Executive Committee meeting were:

The Executive holds its **annual strategy workshop** in April. A key focus will be considering the implications for the BGA and the gliding movement of the new EU regulatory framework. Pete Stratten, as CEO-designate, will be attending the workshop.

BGA continues to support the **GAAC**, which tracks County Structure Plans and provides input to protect our interests, and **GASCo**, which brings together and disseminates facts and initiatives on safety.

The BGA Chairman, also Chairman of NPLG Ltd which administers **NPPL** licence applications, reported on the first period's accounts and current prospects, saying that the results so far were better than plan and the prospects good. NPLG is jointly owned by the PFA, AOPA and the BGA. The NPPL has been very successful: over 1,000 licences issued up to December, including 113 for SLMC.

The second reading of the EU third party **aviation insurance draft legislation** was due to go before the European Parliament on March 10. Following over a year of representation and lobbying activity, much of it in 2003 led by David Roberts through the Royal Aero Club, the proposals contained an amendment to exclude gliders. The BGA was not against the principle of legally binding requirements for third party insurance, but objected to the indemnity figures first proposed (£68m per aircraft!) and the scope of cover required, which included war, terrorism, hijacking (!) and sabotage. The indemnity levels are now far more realistic but the wide cover is still in the proposed legislation. Hence the backing for the amendment to exclude gliders in the absence of modification to the cover requirements.

David Roberts



## Windrushers GC

**PLANS** are under way to revive Windrushers GC at Bicester in Oxfordshire after a gap of more than 40 years. The original Windrushers formed in 1956 at Bicester but became part of the RAFGSA Centre in 1963. When the Centre moves to RAF Halton in June 2004 the 85-year-old airfield (above) will be surplus to MoD requirements and will eventually be sold. A group of pilots, many currently flying with the RAFGSA, are re-establishing the club ([www.windrushers.org.uk](http://www.windrushers.org.uk)) to continue gliding from this historic site. Membership will be open to the public and the club will specifically encourage juniors and students to join, with a long-term goal of becoming a centre of sporting excellence. The club is negotiating a short-term lease with Defence Estates to enable gliding to continue. Bicester airfield itself was designated a Conservation Area by Cherwell District Council in 2002 and is an English Heritage listed site. To express your interest in joining the club, email [enquiries@windrushers.org.uk](mailto:enquiries@windrushers.org.uk)

WE are sorry to have to report four UK fatalities already this year. John Heath and Philip Swinden of died as a result of a crash in a two-seater near Husbands Bosworth; Bob Sharman died in a tug accident at Crowland and Derek Sephton died in another tug accident at Parham. Investigations are ongoing. And, as we go to press, news has come in of the death of Lucy Wills, the daughter of Gavin Wills, who is known to pilots across the world because of her appearances in various excellent gliding videos. Our condolences to all those who are affected by these sad losses.

BARRY Rolfe was presented with the prestigious Paul Tissandier Diploma at the Royal Aero Club Awards ceremony as we went to press. Full details of this and other awards to glider pilots (as described on p5 of the last S&G) will be in our June-July edition.

GASCo is running a flight safety event on the theme of "staying in control" on May 15 at the Aviator Hotel, Sywell. The cost is £29 inc. buffet lunch. Apply ASAP to [penny.gould@gen-av-safety.demon.co.uk](mailto:penny.gould@gen-av-safety.demon.co.uk), phone 01634 200203 or send a cheque to GASCo Office, Rochester Airport, Chatham, Kent ME5 9SD.

THE organisers of the 2003 Inter-Services Regionals have asked us to point out that it is open to civilians as well as service personnel and will be held at RAF Cosford. Application forms available from [www.rafgsa.org](http://www.rafgsa.org)

DG Flugzeugbau tell us that they are now definitely the owners of LS ([www.dg-flugzeugbau.de](http://www.dg-flugzeugbau.de))

A REMINDER that the rules to follow if you want to claim the new BGA 1,000K Trophy conceived and donated by Peter Hearne are available as a PDF at [www.gliding.co.uk/bgainfo/competitions/news.htm](http://www.gliding.co.uk/bgainfo/competitions/news.htm)

FOLLOWING a take-over by the THB Group last year, TL Clowes has stopped transacting aviation business as of this March. Its portfolio has been transferred to Robert Fleming Insurance Brokers.

BIDFORD GC inform us that they have changed their annual competition's name to the Bidford Regionals and Turbo Competition and they add that all gliders, non-turbo and turbo, are welcome.

WANTED – by the German gliding and modelling museum on the Wasserkuppe – the Horten 33's centre section, which is lost. At the International Rally there in 1974 the whole aircraft was seen in a barn in a little German village. Does any reader with a long memory happen to recall where? Please contact Chris Wills via S&G's editor if you do.

FLY! The London Air Show, from April 16-18. For info about the show, see [www.londonairshow.co.uk/](http://www.londonairshow.co.uk/)

APOLOGIES for errors in the Annual Statistics in the February-March S&G. A new version is on p52.

THE winner of the BGA 1000 Club Lottery for January 2004 was DC Perkins (£40), with runners-up Mrs GM Eastell and GH Chamberlain (each £20). February winner was G Humphries (£38), with runners-up R Mackie and D Shepherd (each £19).

# BRITISH GLIDING ASSOCIATION • 2004 COACHING PROGRAMME

## INSTRUCTOR COURSES 2004

### ASSISTANT INSTRUCTOR COURSES

Full Fee: £310.00 Young Persons Fee: £155.00

IC 1	3rd – 11th April
IC 2	17th – 25th April
IC 3	15th – 23rd May
IC 4	5th – 13th June
IC 5	19th – 27th June
IC 6	4th – 12th September
IC 7	18th – 26th September
IC 8	2nd – 10th October
IC 9	16th – 24th October

## SOARING COURSES 2004

### SOARING COURSES AT HUSBANDS BOSWORTH

Full Fee: £130.00 Young Persons Fee: £65.00

SCH 1	31st May – 4th June
SCH 2	30th August – 3rd September

### SOARING COURSES AT BGA CLUBS

Full Fee: £130.00 Young Persons Fee: £65.00

SCA 1	5th – 9th July	Snitterfield Airfield
SCA 2	12th – 16th July	Bidford Airfield
SCA 3	19th – 23rd July	Venue To Be Decided
SCA 4	26th – 30th July	Venue To Be Decided

## YOUNG PERSONS 2004

### YOUNG PERSONS CROSS COUNTRY COACHING COURSE

9th – 13th August

This popular course is subsidised by the BGA, so that there is no course fee to pay at all, and every candidate will receive a flying subsidy for the week, although details of this will be confirmed at a later date. Application for one of the places on this course is by letter, to the National Coach at the address below. The closing date for entries will be 30th April 2004.

Mr S Adlard,

2 Victoria Court, Cunnery Road, Church Stretton, Shropshire SY6 2AF

### JUNIOR NATIONALS 2 SEAT TRAINING

14th – 22nd August

This year's course will be run by Terry Slater. He will be assisted by several of the UK's top competition pilots, flying high performance two seat training aircraft, such as the Duo Discus. Application for one of the places on this course is by letter, to Terry Slater at the address below. The closing date for entries will be 30th April 2004.

Mr T Slater,

Sky Brae, Bridewell Lane, Botesdale, Suffolk IP22 1DS

**BRITISH GLIDING ASSOCIATION, KIMBERLEY HOUSE, VAUGHAN WAY, LEICESTER, LE1 4SE**  
 telephone 0116 2531051 • facsimile 0116 2515939 • e-mail [colin@gliding.co.uk](mailto:colin@gliding.co.uk) • web [www.gliding.co.uk](http://www.gliding.co.uk)

# UK CAA VFR Charts

Whatever you fly, don't fly with an out of date chart



**Civil Aviation Authority**

Aeronautical Charts & Data (AC&D)  
 Directorate of Airspace Policy  
 Civil Aviation Authority  
 K6, CAA House,  
 45-59 Kingsway,  
 London WC2B 6TE.

With views & comments, contact  
 AC&D VFR chart editor at  
[vfrcharts@caa.co.uk](mailto:vfrcharts@caa.co.uk)

### 1:500,000 Aeronautical Charts

Chart Name	Current	New
S. England & Wales	15 Apr 04	17 Mar 05
N. England & N. Ireland	15 May 03	13 May 04
Scotland	12 Jun 03	23 Dec 04

### 1:250,000 Aeronautical Charts

Chart Name	Current	New
1. N. Scotland West	19 Feb 04	TBA
2. N. Scotland East	18 Mar 04	TBA
3. N. Ireland	10 Jul 03	7 Jul 05
4. The Borders	30 Oct 03	TBA
5. Central England & Wales	17 Apr 03	14 Apr 05
6. England East	21 Feb 02	10 Jun 04
7. West & South Wales	11 Jul 02	8 Jul 04
8. England South	15 Apr 04	17 Feb 05

Note: Publication dates quoted on this page are subject to change.  
 This product includes map data licensed from Ordnance Survey.  
 © Crown Copyright and database right 2004. All rights reserved.  
 Ordnance Survey Licence Number PU100018846.

A list of approved  
 stockists can be found at  
[www.caa.co.uk/dap/dapcharts](http://www.caa.co.uk/dap/dapcharts)

A textual list of updates that effect published versions of the  
 charts is available online at [www.caa.co.uk/dap/dapcharts](http://www.caa.co.uk/dap/dapcharts)

# Winpilot - VolksLogger - Borgelt - GarMax

- ◆ Flight Computer ◆ Moving Map
- ◆ Full Task Nav. ◆ Airspace warnings
- ◆ Thermal Mapping ◆ View flights
- ◆ Terrain Map ◆ Free Nav. data updates

"Winpilot - The best features, Great Backup, Great for Gliding !!"

**WinPilot** provides the next generation instrument. It is the best, most powerful gliding computer software available, providing a friendly user interface with a fast, high resolution, touch sensitive display. It uses **Compaq iPaq** palm-sized computers. **WinPilot Pro** Combined with an IGC **VolksLogger** and a **Borgelt B50**, **Cambridge 302**, **LX5000**, **LX160 Vario** creates an incredibly powerful platform on which any option found in today's flight computers, and many new ones can be implemented.

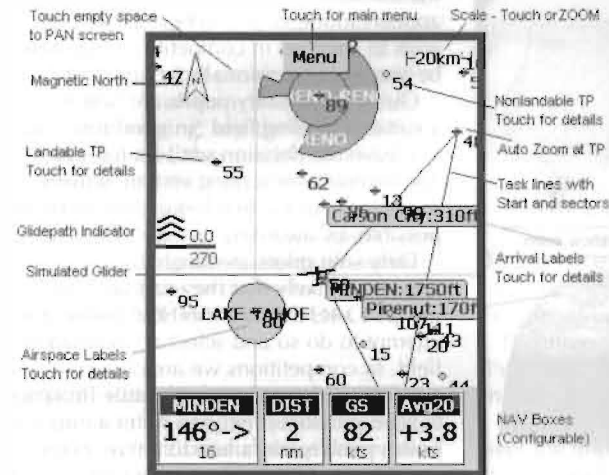

**Borgelt B50** £599 + vat

- ◆ smooth, responsive, quicker centering
- ◆ extremely zero stable vario - rely on it
- ◆ clear, unambiguous displays
- ◆ installation is easy - no flasks
- ◆ analogue display size - 57 or 80mm
- ◆ Wiring harness for link to **WinPilot pro**



**VolksLogger** £519 + vat

- ◆ IGC Logger, clear GPS nav. Display
- ◆ incl all cables and software
- ◆ FAI task declarations and GOTO function
- ◆ BGA2004 waypoints supplied
- ◆ Integrated with **WinPilot Adv. Pro**

**Adv** \$249 needs GPS (NMEA)  
**Pro** \$299 needs suitable Vario system

**GarMax** £40.00+vat - UK Airspace moving map, TPs for **Garmin GPS**  
 The most cost effective gliding TP and moving map!! 2004 update available March

[www.crabb.biz](http://www.crabb.biz)



**Crabb Computing**  
 3 Salford Close  
 Welford, Northants, NN6 6JJ  
 Tel +44 (0)1858 575665 - paul@crabb.biz



**JOINT AVIATION SERVICES LTD**  
 Service with Security

MEMBER



General Insurance  
 STANDARDS COUNCIL

*Probably the largest Sailplane Insurance Agency in Europe*

With Sailplane clients from all over Europe, all receiving the same high standards of service and competitive prices

*Our Policies now include free airside coverage for your car and your syndicate members cars*

**JOINT AVIATION SERVICES LTD**

**0044 (0)1420 88664 General Enquiries or**

Terry Joint 0044 (0)1420 88700 (Mobile 0044 (0)7802 708670)

Bernadette Pollard 0044 (0)1420 88706 • Facsimile 0044 (0)1420 542003

Joint Aviation Services Ltd

No. 8 Old Aylesfield Buildings, Froyle Road, Shalden, Alton, Hants. GU34 4BY

Or visit our website @ <http://www.joint.co.uk> • Or email [bernadette.pollard@jointaviation.co.uk](mailto:bernadette.pollard@jointaviation.co.uk)

## LX avionics Ltd

www.lxavionics.co.uk <http://www.lxavionics.co.uk>

Sole UK Distributor for:  
LX Navigation www.lxnavigation.si

Sole UK Distributor for:  
Filsler Electronic GmbH www.filsler-electronic.de

### VARIOS AND FLIGHT COMPUTERS AND FLIGHT RECORDERS

#### NEW MODEL – Multi Function Controls now fitted to LX 1600 for operation *without* a PDA if needed.

For gliders with very limited panel space, the NEW LX 1600 is ideal, requiring one 57mm hole only!!

- Essential controls mounted concentric with the mounting screws for normal vario operation
- Supplied ready to connect to a PDA for full cross-country capability when connected to a GPS
- All connections ready to plug in and power the PDA (no adaptors needed)
- Delivery "package" deals available to include Colibri and operating software.

See [www.lxavionics.co.uk](http://www.lxavionics.co.uk)

Promotion prices (to 30 April 04)

LX 1600 (no software) **£836.00 plus VAT = £983.47 incl VAT**

LX 1600 with "Navigator" software for PDA **£1056.32 incl VAT**

Software – buy online [www.flytwithtce.com](http://www.flytwithtce.com)



#### A SELF-CONTAINED – FULLY INTEGRATED SYSTEM

##### LX 7000 pro IGC

- Replacement for LX 5000 FAI
- New display (160x240 pixel)
- New design approach: intelligent Vario unit with new sophisticated vario signal processing
- Extremely small dimensions (4 inches maximum length)
- Even more user friendly

- IGC approved flight recorder
- Standard LX data exchange features (TP&TSK Flight Info)
- Full AAT support (zone and move function) and AAT oriented in-flight statistics (distance to go, time remaining, required speed to reach finish in time)
- Data and power interface to LX 20 and Colibri (plug and play)
- Winpilot output
- Options: two seat configuration, remote control, compass, secondary vario indicators
- Wiring harness included (plug and play)



£2610.00 plus VAT

£3066.75 inc VAT

##### NEW LX 7000/Cambridge 302

LX 7000 display for coupling to Cambridge 302 **£1,198.50 incl VAT**

##### LX 160S



The LX 160S is an electrical variometer and final glide calculator with the ability to operate with an external GPS (Colibri, LX 20, LX 400, Garmin etc). When doing so the LX 160S will calculate a final glide to a point selected on the GPS; it also calculates the wind component. Without the external GPS the LX 160S functions as a normal variometer with a final glide calculation using parameters entered by the pilot.

When connected through a LX to iPAQ Adapter ( £42.95 incl VAT) the LX 160S will operate a PDA (iPAQ) with, for example, WinPilot or "NAVIGATOR" program and will give enhanced capability.

Price £836 plus VAT = **£982.30 incl VAT**



##### iPAQ Mount

3 axis freedom

Price £42.51 plus VAT

£49.95 incl VAT

##### COLIBRI

the user friendly flight recorder small and light

(The GPS antenna shown in the photograph below can be installed remotely from the Colibri)

Price £526.81 plus VAT

£619.00 incl VAT



### RADIOS AND TRANSPONDERS

#### ATR 600 Transceiver

Certified to JTSO Standard: No LBA.0.10.91/106 JTSO



- 57mm diameter
- 100 frequency memory with names
- pilot adjustable squelch
- VOX intercom
- accepts most mics
- 150 mA standby
- 700g weight
- HF output power approx 6 Watts

Price £849 plus VAT **£997.57 incl VAT**

#### Remote Control for ATR 600

- 57mm cut out
- Only 45 mm long (without connector)
- Weight 200 gm
- Enables full operation of ATR 600 version 2.1 from rear seat

Price £203.41 plus VAT

£239.00 incl VAT



ATR 600 + Remote – ideal for 2 seaters

#### ATR 500 Transceiver

Certified to JTSO standard: No LBA.0.10.91/113 JTSO

- 57 mm panel hole
- 178 mm long (without connectors)
- Weight approx 700 gm
- HF – output power 6 Watts (approx)
- 9 channel memory
- power consumption 150mA (approx) standby
- power supply 10.5V – 14 V
- VOX intercom

Price £654.47 plus VAT

£769 incl VAT **Deliveries from Feb 04**



#### TRT 600 Transponder with Mode S

CAA Approved under BCAR B4 – 10 Nr: VC 01211

- 57 mm cut out
- 178 mm long
- Easy operation with 4 line LCD
- Modes A, A/C and S
- Integrated Alticoader

Price £1760 plus VAT

£2068.00 incl VAT



#### ALSO AVAILABLE

- "Winter" instruments (to order)
- Lightweight foldable towing arms
- Wing dollies

#### ATR 720A Transceivers

ONLY £599 incl VAT (as available)

Contact: John Delafield 07850 950349 or 01865 374125

E-mail: [John@lxavionics.co.uk](mailto:John@lxavionics.co.uk) [john@fsd.uk.net](mailto:john@fsd.uk.net)

[www.lxavionics.co.uk](http://www.lxavionics.co.uk) <<http://www.lxavionics.co.uk>>

or your regular supplier

LX avionics Ltd price list available – on request Add p&p to all prices E and OE

### Finish lines

EVERY season, we read depressing accounts of pilots crashing their gliders just short of competition finish lines. Why do these accidents happen? Well, part of the reason must lie with the competition scoring system. I'll hazard a guess that had the tasks in question been merely for practice, then the accidents would not have occurred. It appears to me to be a sobering fact that if we wish to succeed in competitions, we have to be prepared occasionally to push our luck.

Our cross-country pupils are taught to pick a suitable landing field "in good time" and not leave the decision until it's too late. The competition scoring system actively encourages us to stretch our glide as far as possible, by awarding us extra points.

Early solo pilots are taught that, if it appears unlikely that they can get back to the club site, then they must abandon any attempt to do so and select an alternative field. In competitions we are obliged to start our final glides as low as possible (in order to save valuable time) and suffer a crippling points penalty for failure to arrive. Every year, the standard of Nationals contest flying gets a little higher, the competition a little keener, and the loss of a few minutes in a race more critical. Add to all this the fact that modern gliders have such remarkably flat glides that realistic judgement about their ability to complete the last few yards of the course becomes ever more difficult.

Small wonder that we have these "landing short" accidents.

The advent of the datalogger has enabled us to lessen some of the more hazardous competition procedures but we've done nothing to improve the safety of the finish line. Other active sports have cushions or crash barriers to protect participants in the event of failure. Hurdlers don't need to jump over brick walls, but have lightweight barriers that can be knocked over easily and painlessly; cricketers and footballers wear pads; the list goes on. In our competition there is no padding provided for the failed final glide. If there happens to be a decent field on the approach to the finish line then fine, but this is of no interest to the Contest Rule Book. If the last mile or two is over trees, cliffs, rocks or wires, it's just too bad.

Suggestion: have a "finish ring" of (say) 1km radius as in the rule book, with a min crossing height of (say, once again) 800ft, but high enough for the lowest, slowest successful finisher to reach the airfield and perform the customary racing finish. The requirement for judgment and skill on the final glide would still be there, but with the added advantage that in the event of failure we have provided a cushion of several hundred feet with no necessity for scraping into the club field at all costs.

I had originally thought of suggesting that the minimum height finish line should be over the airfield, but that would deprive us of the low-level finish, and goodness knows we deserve just a little celebration after a hard

slog around the course. Another idea was to have a scale of failure in hundreds of feet, but that would defeat the entire object of my suggestion. The minimum height would have to be treated as if it were the actual ground.

"Ah," I hear you ask, "what if our old British favourite, the Afternoon Warm Front, approaches, and atmospheric pressure drops? This would give us an over-optimistic reading of our height over the ground, wouldn't it?"

One way round that problem is to equip the finish line observers with a serviceable altimeter. On hearing, say, the ten-minute call from a finisher, they could include a QFE reading with their acknowledgement.

Narrowly failing to finish a race is very frustrating (tell me about it), but it beats going home early in the competition week with a broken glider in the trailer.

**Mike Fairman, WELWYN GARDEN CITY, Hertfordshire**

### **A radical idea to improve safety**

ON a competition or other qualifying flight, it is suggested that: *once a glider descends below a certain height (eg 200 metres/700ft agl), the flight is deemed to have ended at that point.* A by-product of this rule is that all competition finishes must be at least that high. Loggers can determine height above sea level. Height above ground is a little more complicated, but surely not beyond the programmers of logger software to come up with a solution involving integration with large-scale maps.

Inevitably, some small print will be needed. For example, if a finisher passes below the 200-metre cut-off height just short of the line, it would seem unfair that he is deemed to have failed to complete the task. A standard penalty (as per airspace infringement) would be more appropriate.

Certainly this suggestion will not be popular with die-hard racing pilots, but at least should be worthy of debate.

**Jack Harrison, via email**

### **More on CES**

I WAS delighted to read about K-6E CES, now resident in Japan, in the February-March issue (*All the best – the K-6E!* p8). I was also a part owner of CES, which I flew as a member of the Wrekin GC at RAF Cosford and last flew at the Mynd in May 1989. Sadly, the syndicate broke up for various reasons and the glider was sold to Lasham. I regretably did not achieve any outstanding flights in CES other than completing my five hours on the ridge at the Mynd in March 1988, which is a memory I will always treasure, in that beautiful part of Shropshire.

I wish Mr Taneda every success with CES in Japan, which I have also visited and is not unlike the countryside of Shropshire so CES should feel quite at home. I enclose a photograph of me posing after my five-hour flight at the Mynd.

**Don Rhodes, NEWPORT, Shropshire**



*Don Rhodes after doing his Silver duration at the Mynd in the K-6 now resident in Japan. See More on CES*

### **Bad impressions...**

I AM dismayed at the article *First impressions* (February-March 2003, p50).

The three-times CFI asks in the final lines: "I'm still looking for a suitable way to make an impression, any impression. Any ideas?"

Well he has created one, a bad one. He gives the impression that it's OK to tow out of marginal fields. He gives the impression that tuggies are only interested in their own survival. He gives the impression that it's "cool" to stick your neck out to please those in authority. ALL WRONG! I quote: "It was suicide. But he was the chairman".

There can only be one reasonable view of this gung-ho rubbish. It's a bad bad impression. His article should have been five words long: "*If in any doubt, don't.*"

I for one will NOT be looking to fly at his club (which one is it?). I hope his chairman has some educative comments about this article's effect on his club's reputation.

I'm surprised that this article was printed without comment from S&G on the flight safety content.

**Mike Terry, Assistant Instructor, Dukeries**

### **... And good ones**

I would just like to say how much I enjoyed the article on first impressions in last month's S&G and would add that it has made quite an impression on me! I have now landed out four times in the pursuit of my Silver distance and each time it has been a road retrieve. I've never had the pleasure of an aerotow retrieve, however, having read this article I now realise that you land in a field that a tug pilot can get into so as to increase HIS experience in tugging! He's not going to worry about getting your glider dirty on take off or whether you are still on the back of the tug at 2,000ft. He may give you a convincing plan before take-off but don't believe him! So my advice would be to pick your field as you should at 1,200ft – remember surface wind, field length, obstruction, slope, surface and stock. However, I would then try and make sure that there is a good pub near by as you can have a drink and won't have to fly an aerotow retrieve – and a crew will always find a pub if you give them the name of it

and tell them there is a pint waiting for them! I'm going to give my name now in case I can't say it when you arrive at the pub... if only I could remember it!

### **Email address supplied**

*The anonymous CFI replies: I was disappointed by one of these letters about my article and applaud the other. To put things in some perspective, I have been gliding for 34 years, tugging for 32 years, have all three Diamonds and more than 5,000hrs in the air. I am also an ex Full Cat power instructor and the only damage I have caused to anyone is a dislocated thumb for a student in a T-21 (but that's another story).*

*Chill out, Mike, gliding is supposed to be (is) fun and there is a funny side to everything if you look for it. I admit to a little poetic licence in parts of the article and I was warned that it might cause some comment, but I bet it made one or two readers think "outside the box". A lot of the points I made were tongue-in-cheek and if it made just one pilot (gliding or power) think about what they are doing, it was well worth the effort.*

*The anonymous writer of the second letter has read between the lines and has started to think about what he (or she) is doing and equally importantly, what is being done to them. Don't believe all you hear in the bar, and don't believe all you read in S&G. It might be someone like me telling the tale!*

### **Yes, spins**

WHEN I read *Oh no – not spins* in the October–November 2003 issue (p47) I immediately recognised my own response to spinning. I had made the mistake of listening to all the stories that are told in the bar about spins, and therefore I built up a fear of spin training. I thought that spinning would be a lot worse than it really is, as with anything new. I also discovered that 99 per cent of solo pilots will say that they do not like spinning, and the only reason that they do spin is so that they know the correct recovery should they ever need to use it. It has taken me three years to realise that we train to develop the knowledge to recover from spins entered unintentionally.

The way I overcame my fear of spinning was by approaching the same instructor each time I have had to do my spins. Over the previous two years I always had the instructor put the glider into the spin and I recovered it. However, over the last six months I have been putting the glider into the spin and recovering it as well. Since I have been putting the glider into the spin I have started to feel a lot more confident. This is because I know what the glider is going to do and how it is going to respond; I am in control rather than the instructor. I have also discovered that spinning with the same instructor each time builds up my trust in him because he knows how I feel about spinning as well as my other weaknesses.

If anybody has a major problem with spinning like I had, I suggest that you find an

*Please send letters (marked "for publication") to the editor at editor@sailplaneandgliding.co.uk or the address on p3, including your full contact details.*

*The deadline for the next issue is April 13*

Y instructor you get on with and get him/her to introduce spinning gradually and regularly to you. This way you build up confidence with the instructor, the unusual attitudes and also the spinning and recovery. It may seem like a long never-ending tunnel, but if you practise spins regularly the tunnel does get shorter, as I am now finding out as I slowly start to feel happy doing them.

Never listen to bar room stories as all it does is get you worried about things that don't need to be worried about. I made that mistake and it has taken three years to overcome, but now spins seem worth doing as I can see the progress that I have been making recently. It is all worth it in the end.  
**Dawn Goldsmith, COLCHESTER, Essex**

## Airspace databases

"UNOFFICIAL – use at your own risk – always refer to UK Air Pilot for definitive information". Yes, indeed, but I wonder how many glider pilots simply download their airspace databases and use them without checking? More to the point, how many competition scorers also accept that their airspace and waypoint databases are accurate?

I have recently spent a lot of time checking turn point lists downloaded from various programmes against the BGA list, and checking airspace files against the UK AIP data. I have found many discrepancies. Some were gross such as longitudes given as west when they should be east, whole degree errors in latitude or longitude and incorrect radii for zones. There were also many smaller ones.

I am concerned that when I use my on-board equipment, for which I have corrected the files from the definitive sources, to navigate clear of restricted airspace, errors in the scoring programme's database could show a false infringement. The programme could also incorrectly show a missed TP.

The gross errors are clearly due to simple incorrect inputs, but many of the smaller ones are, I believe, a consequence of the gliding movement's insistence on going its own way by continuing with degrees, minutes and decimal minutes when worldwide aviation has standardised on degrees, minutes and seconds. Rounding and other errors then arise from conversions from one

format to the other, and I suspect, back again. The smaller errors that I found were usually no more than .009 of a minute, giving a position error of up to 50ft. Take .341 of a minute, convert it to seconds = 20.46, round that to 20, convert back to minutes, and the result is .333 – a difference of .008.

A position given to the nearest second would be within 72ft (at the equator – less elsewhere) of the exact position. It is presumably for this reason that AIP co-ordinates for most purposes (positions of nav aids, airspace boundaries, airway centre-lines, free-fall parachute sites, etc.) are given only to the nearest second. Where greater accuracy is needed (rarely, such as the position of obstructions close to an airfield) the definition continues with decimals of a second. Do we need any greater accuracy than whole seconds? Would the nearest second not be sufficient? And while we continue with decimal minutes, should we not allow a small (say up to 75ft) apparent horizontal transgression of airspace to go unpenalised to allow for database anomalies? After all, the wing tip of your Nimbus could be 35ft inside the airspace even when your GPS is outside!

Incidentally, I wonder how many glider pilots have put a para zone in their GPS copying directly from aviation sources not noticing that they are entering degrees minutes and seconds as degrees minutes and decimals? With a possible error of half a mile.  
**AHG (Sam) St Pierre, via email**

## Icarus – something fishy?

CHRIS Ellis adds a new dimension to the famous myth with his poem inspired by wave clouds over Crete (February-March 2004, p10). If we go back about 2000 years to the account by Ovid (Metamorphoses, VIII: 230-235) we read that after flying too high, Icarus fell in the sea next to the island where he was buried, an island that still keeps the name he gave to it. This is said to be Ikaría in the Cyclades, 250km north of Crete and close to the Turkish coast.

But the objective of the escape from Crete is variously said to have been either Sicily, or Cumae – an ancient town near Naples. The nearest point of Sicily is 800km over water to the west. Even allowing for some

prudent island-hopping, a competent ancient navigator would have known that there was no need to go as far north as Ikaría, almost 90° off course.

However, the AA guide to Greek Islands says "The prosaic explanation of Ikaría's name is that it comes from the Phoenician word for fish." The Greek for fish is ikhthus. The plot thickens. Baedeker even cites local tales of Icarus drowned in a ship with white sails that sank off Ikaría in a storm.

Have readers any more ideas, new or old, to contribute to the myth?

**Alan Self, CONGLETON, Cheshire**

## Soaring semantics

MY stimulus for putting fingers to keys was a Discovery Channel programme showing a skier with inflated airbags being carried down on the surface of an avalanche instead of being buried by it. They demonstrated the principle by shaking a mixture of small, dense particles (which moved to the bottom) and larger, less dense particles, which were moved to the top.

When obliged to think about it, we know that gravity moves denser materials, be they solids, liquids or gases, closer to the Earth and that they displace less dense materials away from the Earth. We say "warm air rises" which is true, of course, but it can lead to the thoughtless inference that warm air somehow propels itself upward, which is untrue. We would be clearer if we said "warm air is lifted." (Met jargon includes the term "Lifted Index".) Those of particularly generous spirit might even think kindly of the sink around the thermal, recognising its contribution to their climb.

**Norman A Jull, ONTARIO, Canada**

## Coaching for instructors?

LAST year I was talking casually with a capable young pilot and I remarked on how well our top pilots had done in international competition. He seemed to be pleased, but had not heard of these champions or of their achievements. Later, whilst thumbing through a back issue of *S&G*, I came across an article written by Brian Spreckley entitled "Instructors Task Week". In essence, this article was about a national get-together of instructors of varying cross-country abilities

Glider refinishing in Poland • Superb quality • Unbeatable prices

**www.refinish.biz**

BGA approved • 5 week turnaround • Easy delivery • C of A included • 40 satisfied customers  
Contact Steve Crabb on +44 (0)7710 442742 (uk) +48 (0)71 3481043 (Poland) or email info@refinish.biz

being set tasks and flying against or with each other, guided by experienced pundits. From these events, the instructors not only advanced their cross-country skills but also learnt how to give Met briefings and set tasks.

Why isn't this event still running? I can only assume it withered due to lack of enthusiasm, money, duty rostering, family commitments, and so on. Wouldn't the standard of instruction be improved by reintroducing this sort of event, albeit in a reduced form? Perhaps it could be run on a regional basis using regional/national coaches and local rated pundits, and staged over a weekend. It might even be run alongside an Inter-club League fixture with tasks being flown hors concours. It would be fun, and it might just inspire a jaded instructor to light the afterburner of a young future champion.

It was not a fluke that England won the rugby world cup. The seeds were sown over five years ago in a coaching programme co-ordinated from top to bottom by the governing body. It is through good coaching that we produce champions today; good coaches will produce champions tomorrow.

**Tim Barr-Smith, via email**

### Competition entries

LAST year, Lasham and The Soaring Centre used what amounted to a lottery to select the pilots allowed into their regional competitions. This makes a nonsense of the nationals rating list as the pilots "selected" to fly in these larger competitions are very likely to get a higher rating than pilots who fly in smaller ones, even though the smaller regional pilot may have more ability. This can affect a pilot's position on the rating list and the knock-on effect could even affect a World Team selection!

I propose that if a nationals rated competition is over-subscribed, a recognised system comes into play which acknowledges ability. The existing rating system could easily be used for this purpose and would restore some credibility to the rating list.

At the moment, if allowed to progress or degenerate (?), we could finish up with a Christmas Party ballot or a club secretary opening the entry envelopes can decide who flies in the next world team.

**Ralph Jones, MEMBURY, Berkshire**



### Climate and dusty Covers

Why be afraid of dust, rain and sun? Protect your airplanes with effective covers from Sweden. All covers are made of white waterproof web and have very high UV protection. All Sewing is white double thread. We give you 4 years guarantee on the Materials. Easy to wash. I will send product and materials information if you wish.

**For more information**  
Lars-Erik Blom  
Fax 46 504 15150  
Email: [emfo@telia.co](mailto:emfo@telia.co)

## READING LENSES FOR SUNGLASSES

**Flying with sunglasses on?  
Do you need reading glasses?  
Can you read your map clearly?  
Can you see your instruments clearly?**

**OPTX.20/20** are soft plastic reading lenses which turn your standard pair of sunglasses into bifocal reading sunglasses.

**OPTX.20/20** are optically accurate and come in six different reading additions.

**OPTX.20/20** fix easily to glasses lens with water and can be moved to your ideal position on the lens.

**OPTX.20/20** can be replaced with higher correction as the years inevitably pass and your reading addition needs to be increased.

**OPTX.20/20** can be trimmed if necessary to fit any style and shape of sunglasses and will remain optically correct.

**OPTRONIC optical systems. P.O. Box 110, Selby, YO8 3YE. England**  
Tel: 01757 269 269. Fax: 01757 269 248. E-mail: [OptronicGB@aol.com](mailto:OptronicGB@aol.com)

## CP WEST SAILPLANE SERVICE

We only take on work we can start *immediately*

- ◆ All major & minor repairs and maintenance
- ◆ Sailplanes, Gliders, PFA types and Insurance work
- ◆ Wood, Metal or Fibreglass
- ◆ German trained and qualified composite specialist
- ◆ Purpose-built environment controlled workshop
- ◆ CofA, annual and mandatory inspections
- ◆ Weight & Balance, and CofG positioning
- ◆ Modifications, instrument panels, refinishing

Contact **Roger Hurley**  
Tel: 01432 851886 Fax: 01432 850598  
email - [rogerhurley@gliderpilot.net](mailto:rogerhurley@gliderpilot.net)

# Lottery funding: all change

**S**INCE the Lottery Sports Fund opened in 1995, gliding clubs in the UK have benefited from over one million pounds in capital grants.

For the last year, however, funding for gliding projects has been in the doldrums and following the publication of the BGA booklet "Financial Help for Gliding Clubs" in April 2003, there have been further changes which have an immediate effect upon gliding.

Sport England's Chief Executive, Roger Draper, wrote to all sports governing bodies in April, 2003, stating that, due to lack of Lottery funds, capital funding had been frozen and that no new applications could be accepted until "early in 2004".

Sport England has now stated that a Community Investment funding programme is expected to re-open on April 5, 2004, but on a different basis to the Community Projects Capital Fund with which we have become familiar. The principal changes are expected to be:

- (i) Funding will be decentralised and administered on a regional basis, under the nine, newly-appointed Regional Sports Boards.
- (ii) Although eligibility is likely to be much tighter, gliding will still be eligible for funding under the Community Investment Programme.
- (iii) There will be a new application procedure, new application pack, new forms, etc. An "entry form" or "initial bid" will be dealt with centrally, after which, if the bid is successful, the appropriate region takes over and a case officer is appointed to advise and assist with the detailed application.
- (iv) No specimen forms are available until April 5. Meanwhile, any new information is likely to appear on Sport England's website

– [www.sportengland.org](http://www.sportengland.org) – under "press releases".

(v) Funding will be available for capital or revenue projects, or ones with an element of both. Applications will be assessed against regional priorities.

## Priority investment

Sport England announced in November 2003 the 20 key sports to receive prioritised investment, its streamlined funding plans to ensure that these sports deliver sporting success, and a £130 million fund specifically available for sports governing bodies. Although gliding is included in Sport England's list of 106 recognised sports, it is excluded from the priority list, which consists of:

Athletics; Badminton; Canoeing; Cricket; Cycling; Equestrian; Football; Golf; Gymnastics; Hockey; Judo; Netball; Rowing; Rugby League; Rugby Union; Sailing; Squash; Swimming; Tennis; Triathlon.

Gliding is classed as a development sport by UK Sport.

## What should gliding clubs do?

There is still plenty of preparatory work that can be done so that clubs are ready to "hit the ground running" when the new capital funding scheme opens in April 2004.

Clubs should prepare a Business Plan and a Sports Development Plan which should concentrate upon providing community benefits (with special reference to disadvantaged groups) and sporting gain.

Contact your development officer during the interim period before capital funding reopens, in order ensure that you are properly prepared for your next project.

**Roger Coote**  
BGA Development Officer

# Motorglider Workshops

**D**URING the winter months, the BGA has held a series of Motorglider Workshops. The idea of a workshop seminar originally came from Ken Ballington, who suggested the concept to me at the 2003 BGA AGM and again at the PFA rally, where we discussed the idea in depth. The problem that Ken highlighted, and which I completely agree with, was that the BGA has not in recent years offered any form of training to inspectors and CAA paperwork is a particular problem area.

The fact is, the paperwork for motorgliders has been steered more into line with the rest of General Aviation by the CAA and the vast majority of inspectors and owners have not been exposed to any great extent or been trained on paperwork requirements and procedures.

So far, we have held three workshops: Saltby (in the local pub function room), Parham and Nympsfield. All were very well attended delegates from the local area, some coming a few hundred miles and one delegate from as far away as Spain. We had representatives from the general inspector community, senior inspectors, professional repairers, members of the BGA Technical Committee and owner/pilots.

The general format of the day was as follows: in the morning session I gave a presentation on CAA paperwork requirements, covering required documents, log books, Cs of A, registration, maintenance records, procedures, LAMS, flight testing and weighing. That was the hard bit! The subject of CAA Air Legislation is a huge subject and a whole week could be spent on it and still



**XK10 "CLUB" VARIOMETER**  
**£269**



**CLEVER BOX VARIO**  
**£299**

## CLEVER BOX VARIO SYSTEM

★ See our website [www.cairaviation.co.uk](http://www.cairaviation.co.uk) for details of this new exciting variometer system from the same stable as the ubiquitous XK10 Vario System

from **Cair Aviation Ltd.**

"You can bank on us"

**Prices shown exclude VAT and carriage**

✦ **New Instruments:** PZL Expanded Scale ASI's, 1.5 Turns 0-140kts £129, 1.75 Turns 0-200kts £139, PZL Zero Reset Varios, Flask and Ring, 80mm (Glider) £219, Extended Scale (Motor Glider) £199, 57mm (Glider) £219, PZL EZS5 Mini T/S £299, Lunik Mini T/S £259, American Mini T/S £269, Sensitive Altimeters £149-£153, PZL Altimeter £109, Mini Accelerometer £159, CM24 Bullet Pedestal Compass £49, LC3 Panel Compass £47, Vertical Card Compass £139 ✦ **Surplus Tested Instruments:** Horizons with new Solid State Inverter, Ferranti Mk6 £329, Mk14 (Coloured Display) £409, Mk31 (Coloured Display and Integral Slip Ball) £499, 80mm Glider rate T/S £114, Smiths Mk20 80mm Altimeter 6 O'clock Knob, £114, Mini Accelerometers £99 ✦ **Radios:** Delcom 960 Panel Mount £249, Hand Held £216.90, ICOM A3E £276, Glider Battery Charger £19.90 ✦ **BGA Approved "Ottifur" Releases:** Original New "Ottifurs" £199, Latest "Ottifur" alternative release for modern gliders – Aerotool CW400 series £179, C of G CW300 series £219, Exchange OM series £119, CW series £99, Spring Kits available all series, New "Ottifur Gold" Launch Safety Weak Link Carrier £9.50.

**CAIR Aviation Ltd, Steephill House, Felcot Road, Furnace Wood, Felbridge, West Sussex RH19 2PX Tel: 01342 712684 Fax: 01342 717082**  
e-mail: [colin@cairaviation.co.uk](mailto:colin@cairaviation.co.uk) [www.cairaviation.co.uk](http://www.cairaviation.co.uk)

# E-news from the BGA

not cover everything. By necessity, the presentation was not too in depth and wide-ranging. Another of the objectives was audience participation. Delegates were invited to ask questions to clarify anything that was not clear or a pertinent point that they had a problem with. With luck, we resolved some of the burning issues or at the very least, pointed them in the right direction to get the information that was needed.

In the afternoon, a series of short lectures was given on subjects of interest to inspectors, such as instrument calibration, maintenance of tow releases, sailplane evolution, design and inspection techniques.

One of the main objectives was to use the workshop as an open forum to ask questions, contribute and generally mix with other inspectors and make new contacts. This is especially useful to put faces to names and for inspectors to get to know the Chief Technical Officer and *vice versa*.

From the comments received, I believe that most inspectors and pilot/owner delegates, some of whom were not inspectors, gained some very useful information on the paper-work side of their operation. One delegate even told me, in confidence, that he was not aware that a six-month, low utilisation, check was required on an aircraft maintained until today.

It is hoped to hold more workshops in autumn/winter 2004/5, if suitable clubs wish to host an event. All that is needed is a local co-ordinator, suitable venue, somewhere to get lunch and a local speaker (or speakers) for the afternoon talk on a technical subject. The BGA will support the event and provide all the administration. As we have held workshops in the East Midlands, South East and South West, we would very much like to offer the opportunity to other parts of the UK (including Scotland and Northern Ireland). Please contact the CTO if you wish to discuss a possible venue.

**Jim Hammerton**  
BGA Chief Technical Officer

**F**OR some time now, we have wanted to make more use of electronic channels to communicate with individual glider pilots. The BGA website ([www.glidering.co.uk](http://www.glidering.co.uk)) has now firmly established itself as one of the primary sources of information for the gliding community and we are now making increased use of our own form of electronic commerce. Did you know, for example, that some 90 per cent of the entries received for this year's nationals were made through the website?

I am pleased to announce that a range of information is available for you to subscribe to electronically. If you visit the BGA website and register, you will be able to sign up to receive your choice of information by email. The BGA newsletter is available immediately and subscribers will automatically be sent their own copy as soon as it is published. Like the paper version (which will still be sent to clubs), the e-newsletter will contain short news items, but you will be able to link directly to the full story by a simple mouse click.

A range of other publications and classes of information will be made available (see the website for full details). In addition, you can sign up to alerted whenever a section of the website that is of interest to you is updated.

This service is available to all BGA club members, so sign up now.

## National Gliding Week

What is your club planning for National Gliding Week?

The week has been designed to help us showcase British gliding in all of its forms and to provide a focus that we can all use to generate more publicity for our sport at both the national and the local level. National Gliding Week is an umbrella under which

we hope BGA clubs will run a wide range of events to show everything that is great about our sport.

The more events planned, the more newsworthy the week should be and the more press and public interest we should be able to generate. However, without a good range of events, National Gliding Week will not succeed in its aims. As I write this, I have heard of activities that have been planned by a number of clubs, but I really need to hear of more! Please think about what your club can do and when you plan something let me know, either by contacting me directly ([keith@gliding.co.uk](mailto:keith@gliding.co.uk)) or by entering details of your activity directly on to the new National Gliding Week website, [www.nationalglidingweek.co.uk](http://www.nationalglidingweek.co.uk)

## Club marketing seminars

During February we held a series of marketing seminars to help clubs understand how to turn their strategic objectives into a set of appropriate and consistent marketing messages; decide how best to get these messages to their target market; and help them to work with their local media (press, TV, radio, etc). A total of 20 clubs were represented at the seminars, held at Husbands Bosworth (all-day event) and at Sutton Bank and Bicester (evening seminars). Feedback from delegates showed that the seminars were worthwhile and met a real need. With a few changes, prompted by the feedback, we hope to hold more seminars late in the year, based on the all-day format, at a new range of venues.

Hopefully, other clubs will decide to attend – the overwhelming feeling of those that attended the first set of seminars was that they were well worthwhile.

**Keith Auchterlonie**  
BGA Communications Officer

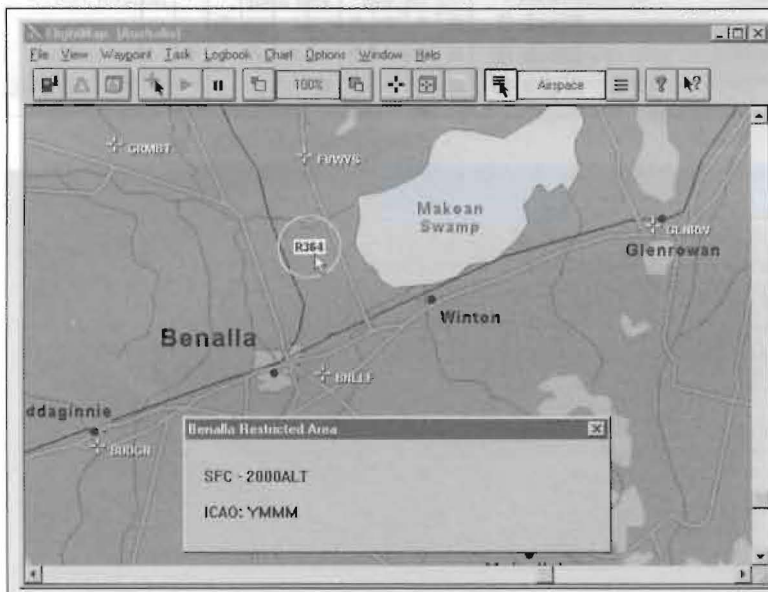

## FlightMap Upgrade Offer

FlightMap is being upgraded with new planning and analysis features that include more comprehensive airspace information. The emphasis on ease-of-use is retained as are the existing facilities for:

- Task preparation.
- Flight display and analysis.
- Logbook maintenance.

The new features will become available in FlightMap Version 2.1. For information on availability and offers for purchasing the current Version 2.0 with a free upgrade, visit:

[www.flightmap.co.uk](http://www.flightmap.co.uk)

Illustration shows the Inspect facility being used to interrogate the airspace map layer.

# BENALLA - AUSTRALIA

- Cross-Country training courses
- Up to 12,000 feet cloudbase
- High Performance Fleet
- Mountain Flying Camps
- Big Fields—very safe
- No cluttered airspace
- Plenty to do—just in case
- Township only 1 km away
- Get your badge and distance claims

- Warm club atmosphere
- Close to Melbourne (2 hours)
- World Comp site—Great flying

## Gliding Club of Victoria

PO Box 46, Benalla, Vic 3672, Australia  
 Telephone: +61 3 5762 1058  
 Fax: +61 3 5762 5599

Email: [gliding@benalla.net.au](mailto:gliding@benalla.net.au)

Visit our website at  
[www.gliding-benalla.org](http://www.gliding-benalla.org)



## ROGER TARGETT

### Sailplane Services



Bristol & Gloucestershire Gliding Club  
 Nympsfield, Nr. Stonehouse, Gloucestershire GL10 3TX  
 Tel: Workshop (01453) 860861 • Home (01453) 860447  
 Mobile 07850 769060

— email [roger@targett40.freeserve.co.uk](mailto:roger@targett40.freeserve.co.uk)

[www.sailplaneservices.co.uk](http://www.sailplaneservices.co.uk)

### Offering outstanding workmanship, efficiency and service in:

- ★ All glass, carbon, kevlar, wood and metal repairs and modifications
- ★ Motor glider engine approval
- ★ C of A renewals and general maintenance
- ★ Weighings, including accurate in flight C of G positioning
- ★ Re-finishing in all types of gel coat and paint
- ★ Hard wax polishing
- ★ Competition sealing
- ★ BGA and PFA approved
- ★ Canopy perspex replacement
- ★ Aircraft recovery



## SOAR Minden

PROUDLY ANNOUNCES:

### THE BLOCKS ARE BACK!!

LIMITED NUMBER OF BLOCKS AVAILABLE • SALE ENDS MAY 15, 2004

For Rent: Grob 103, Grob 102, Discus B, LS-4, LS-3A, Mini-Nimbus

### SOAR Minden

PO Box 1764, Minden, NV 89423 • 800 345 7627  
[www.soarminden.com](http://www.soarminden.com) [soarminden@power.net](mailto:soarminden@power.net)  
 Visa/Mastercard Accepted Established 1972

**PREPAY \$3000.00  
AND GET:**

	MIX AND MATCH SERVICES	CONDITIONS								
	AEROTOWS	AIRCRAFT RENTAL	INSTRUCTION	2 YEARS	4 YEARS	ASSIGNABLE	\$3,900.00 VALUE	\$4,200.00 VALUE	\$4,800.00 VALUE	\$6,000.00 VALUE
Block I	•	•	•	•	•	•				
Block II	•	•	•	•			•			
Block III	•	•	•		•			•		
Block IV	•	•		•						•

If you want your club,  
site or business to

## BE SEEN

by advertising in S&G, please  
 telephone Debbie Carr  
 on +44 (0) 116 253 1051  
 or email [debbie@gliding.co.uk](mailto:debbie@gliding.co.uk)

AIRBORNE



GROB

**SPECIALISING IN GROB GLIDERS AND  
 MOTORGLIDERS. SPARES, SUPPORT AND  
 SERVICE FOR ALL THE GROB SINGLE SEAT  
 GLIDERS**

Please fly in, call or write to:

Tim Dews, Airborne Composites UK Ltd, The Hangar, Wing Farm,  
 Longbridge Deverill, Warminster, Wiltshire BA12 7DD  
 Tel: 01985 840981 (Workshop) or 01985 841125 (Home)  
 Fax: 01985 841126 Mobile: 07778 963277

E-mail: [Tim@Airbornecomposites.co.uk](mailto:Tim@Airbornecomposites.co.uk) Web: [www.airbornecomposites.co.uk](http://www.airbornecomposites.co.uk)





Photos and information courtesy of Chris Willis

## Hortens "at home"

FLYING wing enthusiasts went to Berlin in February to admire four Hortens being restored to static exhibition condition under the supervision of Holger Steinle. The aircraft – a Horten II, Horten IIIb, the two-seater Horten IIIh and the Horten VI – had been taken to the US from Germany at the end of WW2. They are destined for the NASM's 65-million dollar Steven F Udvar Hazy Centre at Washington's International Airport, although the intention had been to exhibit them in the new German Technical Museum, due to open in 2005. Now the Americans have asked for the gliders' return in July 2004. Seen (clockwise from top) are: the 24-metre 1944 Horten VI – at a hoped-for 44:1 the most efficient type in the world at that time; the beautifully restored Horten IIIh – a prone-piloted wing where a horn rotates around the tube on the fuselage centre-line for roll control and slides along it for pitch control. The final photograph shows the Hortens VI again, awaiting its D-box ply and its trailing edges inboard of the elevons. Better news for Europeans is that the museum has drawn plans of all the Hortens – and that Bernd Ewald has persuaded six German organisations to contribute towards building a flying replica of a Horten IVa.

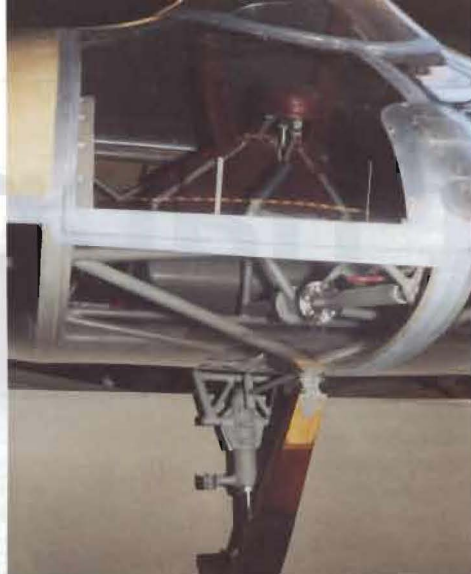

## News from IGC

THE FAI Gliding Commission (IGC) held its Annual Plenary Meeting in Switzerland in February.

Bob Henderson (NZ) was elected as the new IGC President, replacing Tor Johannessen (Norway), President for the last six years, who was unanimously elected President of Honour. Eric Mozer (USA) was elected as First Vice-President, while Roland Stuck (France), Brian Spreckley (UK), Dick Bradley (South Africa), Axel Reich (Germany) and Vladimír Foltin (Slovakia) were elected as Vice-Presidents. IGC's prestigious Lilienthal Medal was awarded to the father of the World Class glider, Piero Morelli (Italy). Peter Ryder (Germany), IGC President of Honour, and Tapio Savolainen (Finland) were awarded the Pirat Geheiger Diploma.

The meeting decided that World Championships from 2006 will be split into two events – the Open, 18-metre 15-metre together, and the Standard, Club and World together – both to be held in even years. The bids for 2008 will be decided in March 2005. The Juniors will remain in two classes with three pilots per class. The Women's will remain with three classes. These contests will be held in odd years. There will be a Grand Prix Championships in odd years, the first in 2005, with the winner becoming World Grand Prix Champion. The 2006 World Championships in the Club Class will be at Vinon in France, along with the World Class. There will be a European Championships in 2005 in Slovakia in the Club, Standard and 18-Metre Classes. There may be a bid from Finland to hold a European Championships in the 15-Metre and Open Classes. The limits for the entry into the Europeans in 2004 were changed to allow two pilots per National Aero Club per class. A proposal to introduce a 20-metre two-seater class was postponed to be considered by the championship working group. A proposal to finish the World Class in 2009 was defeated.

A sub-committee was established to consider the alternatives for the celebration of the FAI's 100th anniversary in 2005. Suggestions are: a world-wide simultaneous gliding day; a world-wide Grand Prix events; a distance day to achieve the maximum possible distance flown around the world. Other ideas are invited.

There were several changes to the rules, the main ones being:

- To allow the use of 500-metre cylinder for badge flights using flight recorders, from October 1, 2004.
- Only one distance record may be claimed from one flight.
- The rule for FRs needing calibration after a flight will change from one to two months.
- There was a lengthy discussion regarding max weights: the outcome was no change in the rules for 15-Metre, Standard and 18-Metre Classes. The Open Class is to continue with limits of 750kg for gliders and 850kg for motorgliders (this rule will apply in Lithuania). The proposal to restrict the rule to limit the open to 750kg from 2006 was narrowly defeated.
- A 750km Diploma will be introduced; this will be issued at National Aero Club level but will be an FAI diploma.

The IGC objectives were amended to include licensing and airspace issues. The main officials for the WJGC at Husbands Bosworth in 2005 were approved, they are Chief Steward Dick Bradley and President of the Jury Ross McIntyre. There was a major discussion regarding the downgrading of IGC approved flight recorders. The IGC have endorsed the On-line Competition.

The next Plenary will be on March 4-5, 2005.

Brian Spreckley

## Dates for your diary in 2004

Dan Smith Memorial Trophy	Dunstable	27/3 - 28/3
Overseas Championships	Ocaña, Spain	24/5 - 4/6
National Aerobatic Comp	Salby	3/6 - 6/6
Bidford ("turbo") Regionals	Bidford	12/6 - 20/6
Booker Regionals	Booker	12/6 - 20/6
Club Class Worlds	Norway	13/6 - 25/6
Competition Enterprise	Aston Down	26/6 - 4/7
18 Metre Nationals	Tibenharn	26/6 - 4/7
Northern Regionals	Sutton Bank	26/6 - 4/7
Lasham Regionals	Lasham	3/7 - 11/7
Club Class Nationals	Pocklington	10/7 - 18/7
Standard Class Nationals	Aston Down	24/7 - 1/8
European Championships	Lithuania	25/7 - 7/8

Inter-Services	Cosford	31/7 - 8/8
Regionals/Junior Pre-Worlds	Soaring Centre	31/7 - 8/8
Gransden Regionals	Gransden	7/8 - 15/8
Western Regionals	Nyrmsfield	7/8 - 15/8
Junior Championships	Lasham	14/8 - 22/8
15 Metre Nationals	Lasham	14/8 - 22/8
Dunstable Regionals	Dunstable	21/8 - 29/8
Open Class Nationals	Tibenharn	21/8 - 29/8
Eastern Regionals	Tibenharn	21/8 - 29/8
Two-Seater Competition	Pocklington	22/8 - 29/8
Mountain Competition	Aboyne	5/9 - 11/9
Salby Open Trophy	Salby	11/9 - 12/9

Advance notice: Guild of Aviation Artists' Exhibition, July 20-25

# flyWithCE

## Navigator

- Easy to use moving map
- Intuitive and very easy to use
- Large buttons that are designed for cockpit use
- Final glide and wind calculation
- Easy task editing and tracking (with AAT support)

- Records unofficial IGC files
- Support for standard file formats
- Support for standard GPS, LX Navigation, Borgelt, Zander and Volkslogger

Do not pay extra for the software features that you will never use.

Try [www.flyWithCE.com](http://www.flyWithCE.com) instead

Free 30 days trial registration. Price – very competitive.

# How it happened

**This year is the British Gliding Association's 75th anniversary. Our series of articles to mark the occasion begins with an account from the man who started it all – Duggie Culver**

**T**HE inspiration for the present British gliding movement certainly came from *The Aeroplane* newspaper; I believe that Mr Thurstan James was really responsible for the Gliding Number of *The Aeroplane* which was published on November 6th, 1929, but it had the benevolent blessing of the editor, CG Grey. The result of the articles on German gliding published in this issue was a flood of letters to *The Aeroplane*, amongst them being one from myself containing certain suggestions which apparently met with approval, for I was invited to call at *The Aeroplane* office for an interview with Mr Thurstan James.

At this meeting I offered to undertake to organise a luncheon party at a West End restaurant at which anybody who was interested in the subject would be welcome. Mr Grey and Mr Thurstan James agreed to push the lunch in *The Aeroplane* as soon as I found a venue and fixed a date.

There were, of course, certain difficulties. I had no idea of the probable number to be accommodated, and without this information restaurant keepers were chary of giving me a date. In the end, by giving a guarantee of a minimum of twenty-five, the Comedy Restaurant in Pantom Street undertook to do the job and the date, December 4th, was fixed.

On the appointed day I arrived with Mr Grey and Mr James and found no less than 56 people present. I also discovered to my disgust that I was expected to take the chair.

Well, the Comedy gave us an excellent lunch and we then got down to business. I opened the proceedings by suggesting that those present should form a gliding club with a small subscription, find an easy site and purchase a Zögling from Germany. I was

"Soaring history was made in 1929," wrote Alan E ("Doc") Slater in the extract illustrated here, "It was the year in which sailplanes finally threw off the chains which had bound them to hilly country." Cross-country achievements by pilots such as Johannes Nehring, Robert Kronfeld and Wolf Hirth were to rekindle British interest in gliding and soaring. Ten years later, as editor of *The Sailplane and Glider* (forerunner of today's *Sailplane & Gliding*) Doc Slater asked Duggie Culver – a former RNAS and RAF pilot in WW1 – to recall the events that led to the founding of the BGA. Like so many other good ideas, it all began with an excellent lunch...

(With grateful thanks to Wally Kahn for locating this article in *The Sailplane and Glider* November/December 1939, p226/7)

followed by several speakers, amongst them being Mr RF Dagnall, Mr Marcus Manton, Mr JR Ashwell-Cooke, Captain Latimer-Needham, 'Jimmy' Lowe-Wylde and Mr Howard-Flanders. Eventually, round about 4pm, the party broke up, having accomplished very little except the installation of Mr Howard-Flanders as Hon Secretary, and myself as Chairman, of a body with vague ambitions, to be known as the "British Gliding Association".

That is the story of the "Gliding Lunch", as it has come to be known, and the birth of that troublous and much-maligned body, the BGA. But it is not the full story, for

A 1931 membership card for the BGA, which underwent several transformations in its early years. Mr Delaney, who lived at 81, The Avenue, Brondesbury Park NW6, paid one pound and a shilling and in return received a book of rules, a *Journal* (see opposite) and *Bulletin* along with his card (Does any reader happen to have a copy of the book of rules or of a *Bulletin*?). Many thanks to Jim Lynchehaun for donating this ticket and the associated correspondence to the BGA

226

*The Sailplane*

November/December, 1939

## Ten Years Ago

**T**HE British gliding movement is exactly ten years old. But few of those who are to be blamed for it was there, or was less so, than Mr D. C. Culver, who took the leading part in that important, in calendar this important holiday by founding the event. Mr. Culver served in the R.N.A.S. and R.A.F. in the last war, and in August, 1918, was shot down near Dieppe and made a prisoner of war. He obtained his "107" certificate with the London Gliding Club in July, 1929.

Soaring history was made in 1929. It was the year in which sailplanes finally threw off the chains which had bound them to hilly country. So it would be fairly to give a list to the principal soaring achievements of that year, which were responsible for the reawakening of interest in Britain. Here they are: June 1929—Johannes Nehring assigned to a captain of RM 2,900 (£230) offered by terms of an agreement for the first soaring flight of 100 kilometers. Soared along Bergstrasse in range of mountains south of Thierhaupten, but landed after 70 km. near Ulm with wings broken in a 12-mile gap.

April 1929—Robert Kronfeld, at Wasserschloß, glided to 1,190 ft. under a complete artificial world's altitude record (official record of 1,000 ft.).

April 22/29—Nehring tried again, along some route, and got by down in the same gap (distance 70 km. 115 miles—so far)—second flight under similar conditions, but with wings broken.

May 1st 1929—First soaring contest in U.S.A. at Long Beach, California. 7 airlines.

May 21st—Several led the German Post race along Thierhaupten, with a time of five hrs. in N.W. Germany set down in a gap after 25 hrs.

MAY 13th—Kronfeld tried again and succeeded in being timed for 100 miles gaps, with 64 miles—just over 100 miles and won the record 1929-30.

June 1929—Start of 1929 annual flight contest at Wasserschloß 36 sailplanes entered.

JULY 29th—Kronfeld made world's first deliberate thousand-foot flight, Wasserschloß to near Jena 30 miles (actual distance record), 2,954 ft. (world's height record).

JULY 22nd—Wolf Hirth made out-of-control (and slight) 60 miles, over sea, Wasserschloß to Schleswig.

TRAY 23rd—Kronfeld, flying blind in darkness, touched 2,044 ft. (world's record) and soared from Wasserschloß to near Bayreuth, 33 miles (world's record). Grounded, with passengers, at 22 miles and landed 1,153 ft. inside cloud, both world's records for two entries.

SEPTEMBER. Russian contest in Crimea 20 airlines.

October 1st—In Alghero, Sardinia, W. Kronfeld soared 1 hr. 40 mins., over 18 miles and landed 100 ft. at 100 miles record in U.S.A.

October 22nd (3.19 hrs.) to 20th (10 hrs.)—Olivier. Dornier soared at Roskilde, East Prussia, for 11 hrs. 45 mins. 2 world's flight records.

November 22nd—At nearly 10,000 ft. at the mountain, Poland, Gronowicz soared 2 hrs. 11 mins. 100 ft. record.

December 4th—"Gliding Lunch" in London (see below).

December 19th—W. Hirth's British record U.S.A. duration record to 2 hrs. 47 mins.

## How It Happened

By D. C. CULVER

**T**HE inspiration for the present British gliding movement certainly came from *The Aeroplane* newspaper. I believe that Mr Thurstan James was really responsible for the Gliding Number of *The Aeroplane*, which was published on November 6th, 1929, but it had the benevolent blessing of the editor, CG Grey. The result of the articles on German gliding published in this issue was a flood of letters to *The Aeroplane*, amongst them being one from myself containing certain suggestions which apparently met with approval, for I was invited to call at *The Aeroplane* office for an interview with Mr Thurstan James.

At this meeting I offered to undertake to organise a luncheon party at a West End restaurant at which anybody who was interested in the subject would be welcome. Mr Grey and Mr Thurstan James agreed to push the lunch in *The Aeroplane* as soon as I found a venue and fixed a date.

There were, of course, certain difficulties. I had no idea of the probable number to be accommodated, and without this information restaurant keepers were chary of giving me a date. In the end, by giving a guarantee of a minimum of twenty-five, the Comedy Restaurant in Pantom Street undertook to do the job and the date, December 4th, was fixed.

On the appointed day I arrived with Mr Grey and Mr James and found no less than 56 people present. I also discovered to my disgust that I was expected to take the chair.

Well, the Comedy gave us an excellent lunch and we then got down to business. I opened the proceedings by suggesting that those present should form a gliding club with a small subscription, find an easy site and purchase a Zögling from Germany. I was

followed by several speakers, amongst them being Mr RF Dagnall, Mr Marcus Manton, Mr JR Ashwell-Cooke, Captain Latimer-Needham, 'Jimmy' Lowe-Wylde and Mr Howard-Flanders. Eventually, round about 4pm, the party broke up, having accomplished very little except the installation of Mr Howard-Flanders as Hon Secretary, and myself as Chairman, of a body with vague ambitions, to be known as the "British Gliding Association".

That is the story of the "Gliding Lunch", as it has come to be known, and the birth of that troublous and much-maligned body, the BGA. But it is not the full story, for

Mr RF Dagnall followed it up by building, and presenting to the BGA, "A.T.1", or, in other words, the RFD-built American trainer which is now universally used in this country and known affectionately as the Dagling; he also imported a Zögling from Germany. Later, following a further lunch at the Comedy, which might be described as a sub-committee meeting, the London Gliding Club was formed. At this lunch were a select few of the more enthusiastic element: Mr Thurstan James, Mr CL Startup (also of *The Aeroplane*), Mr Stanley Bradshaw, Mr Ashwell-Cooke, Mr Blythe, Mr Leslie Melville, and myself. Jimmy Lowe-Wylde was busy forming the Kent Gliding Club and building a BAC1. The highbrow portion of the BGA was making rules and pinning flags on a map as each day a new club was formed, but it was also raising money: £1,000 from Lord Wakefield, and sundry smaller amounts combined to set it up in an office and devise a plan to import Herr Kronfeld and the Wien to Itford Hill in June, 1930. The Daily Express gate-crashed the party with Magersuppe and a Professor, but it was a good party and really got British gliding on the move.

### The British Gliding Association,

44A, DOVER STREET, W. 1.

MEMBER.  
(1931)

Mr. D.C. Delaney.

J. L. R. WAPLINGTON,

PHONE: REGENT 3793.

SECRETARY.

speed, it is possible in principle to obtain a net gain. If the net rate of gain equals or exceeds the rate of descent this "dynamic lift" becomes possible. It is quite probable that some dynamic gain was obtained in the earlier flights, but not by any systematic use of the wind fluctuations.

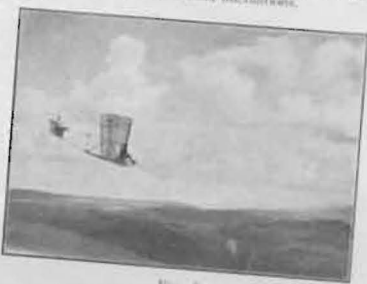

FIG. 8.  
Instructional glider "Zögling" of the  
Rhein-Bohlen Co., 1926.



FIG. 9.  
Western glider of the Wasserwerke, Rhin.  
(Main sailing-flight device.)

The extensive efforts made from 1921 to 1923 to connect publishing dynamical effects with the performance of man-carrying gliders did more harm than good to the development and reputation of soaring, the possibilities of which, apart from any such efforts, have been fully shown by the subsequent years.

## The British Gliding Association

Telephone: REGENT 3793

44a, DOVER STREET, W.1

The British Gliding Association, which was inaugurated on 27th March, 1930, has as its objects—  
"To promote, encourage and control gliding in all its forms."  
The Association is providing information on gliding and soaring flight to all engineers and its affiliated Gliding Clubs.

A journal dealing exclusively with the problems of gliding and soaring flight has been started by the Association. This is circulated to all members and may be purchased by non-members, price 2/6 per copy.

Examples of approved type gliders may be obtained from the Association by non-members and members of the Association.

The British Gliding Association is in close touch with the German Deutscher Gesellschaft der National Glider Association of U.S.A., and the Gliding Associations being formed in the British Empire. This secures that the latest information on the technical aspects of gliding is available to the Gliding Clubs affiliated to the Association.

The British Gliding Association arranged the demonstration of Sailplane Flying by Herr Krennfeld, the Austrian Glider Pilot, at Hove, June, 1930, at which Herr Krennfeld turned in instructive form affiliated clubs to enable them to teach their members and start their clubs on safe lines.

This demonstration is the first of what is hoped will be annual events to popularize gliding.

The British Gliding Association has been appointed the controlling body for all sporting events in gliding by the Royal Aero Club. Regulations for ensuring the safety of gliding have been drawn up by the British Gliding Association and approved by the Air Ministry.

Members of the British Gliding Association are admitted free to all gliding meetings under their auspices at which a charge is levied. All subscriptions expire on the 31st January each year except that the last subscription of candidates is nine months after 1st October shall not expire until the 31st January after a full year has elapsed from the date of their joining.

The subscription to the British Gliding Association is £1 1s. 6d. with an entrance fee of £1 1s. 6d.

(Members of affiliated clubs do not have to pay entrance fee).

THE BRITISH GLIDING ASSOCIATION, 44a, DOVER STREET, W.1

### APPLICATION FOR MEMBERSHIP.

#### EXTRACTS FROM OBJECTS AND RULES

"The objects of The British Gliding Association are to promote, encourage and control the science and sport of gliding and the use of gliders in Great Britain."  
(The term glider means any heavier than air machine which does not depend on an engine for sustained flight.)

"The Association shall consist of one central body and as many affiliated clubs as shall be necessary for the promotion of the objects of the Association."  
(Membership of the Association does not constitute membership of an affiliated club.)

Subscription, £1 : 1 : 0 per annum. Entrance Fee, £1 : 1 : 0.  
(Members of affiliated clubs do not have to pay entrance fee).

I hereby apply for membership of THE BRITISH GLIDING ASSOCIATION and agree to abide by the Rules.

Name (block letters) .....

Title, Distinctions or Qualifications .....

Postal Address .....

Signature .....

Date .....

Left: a page from the BGA Journal, No 1, March 1930. The top picture is a Zögling – see overleaf for what this Primary was like to fly. The same issue records that RF Dagnall presented the BGA with one of these machines in early 1930 – the Association's first glider

Right: an advert for the American edition of L Howard-Flanders' and CF Carr's book, first published in the UK in 1930. Howard-Flanders was designated the BGA's first Hon. Sec. at the gliding lunch



Right: the cover of the first issue of the BGA Journal (price 2/6). It was published in March 1930, even though the BGA was officially inaugurated only on the 27th of that month. We are aware of three issues extant of this journal (the others are August 1930 and January 1931). Does any S&G reader know of any later editions?

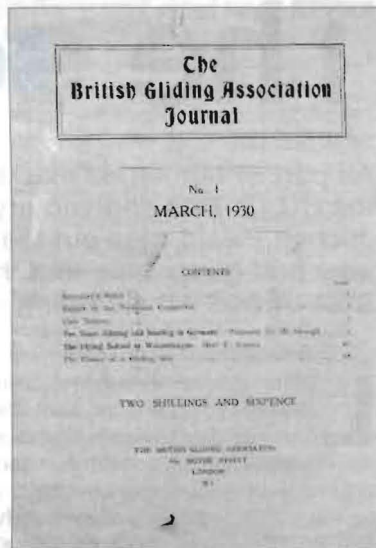

Left: an early membership form for the BGA, which was routinely sent out with copies of the BGA Journal

Right: by 1939, when DC Culver's article was published in The Sailplane and Glider, there were several clubs established across the UK. Midland GC, for example, was settled at its present site. This brochure was for its 1939 instructional camps (Easter, Whitsun, August Holiday and Public Schools), each costing eight pounds and eight shillings. Incidentally, the brochure promotes gliding as: "The sport of youth" – plus ça change! Then, of course, came the Second World War...



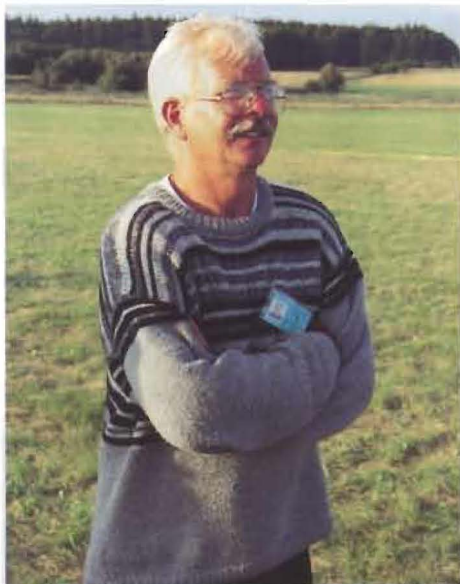

Lazlo Revy built the Zögling from the original plans



# The solo way to learn

**As part of our series marking the BGA's 75th anniversary, Jochen Ewald tries out the very first glider type that the BGA owned – the Zögling**

**L**IFE on Germany's holy mountain of gliding was crazy in the early 1920s. A strange group of enthusiasts would meet at the Wasserkuppe with just one aim, to get airborne, no matter how. And, as powered flying was forbidden in early post-WWI Germany, gliding was the only way for them to get 'their backside off the ground'. But they had to do it the hard way, teaching themselves in self-designed aircraft or in 'gliders' offered by so-called glider manufacturers most of whom never dared to try their own products.

During the mid '20s, the first serious (and now the world's oldest) gliding school was founded at the Wasserkuppe. Its leader and first CFI Fritz Stamer worked to establish a sensible training scheme, together with the Rossitten gliding school based on the dunes of the Kurische Nehrung coast (now Lithuania). These gliding schools formed the Rhön-Rossitten-Gesellschaft (RRG) and worked to publicise gliding as a safe and youth-educating sport rather than a movement of crazy daredevils.

Two-seat training gliders weren't available, and even if they had been they would have been far too heavy to bungee, the only launch method. So Stamer needed not only a training scheme, but also an easy-to-fly, strong and forgiving glider which would be easy to repair.

With such a machine he could standardise the single-seater basic training scheme, beginning with keeping the wings level in the wind and advancing via ground slides and short hops towards real flights.

By 1923, Alexander Lippisch (later a famous aircraft designer) drew up the Hols der Teufel, a light, easy-to-fly trainer (a flying replica of which was built by Mike Beach of the London GC at Dunstable). It had fair performance, but was often damaged during bad landings and was time-consuming to repair. So, in 1926, Lippisch and Stamer designed a real primary glider to be tough and easy to build and repair, the RRG-1 Zögling (Pupil), together with the Grunau 9 Skullsplitter, it was the standard trainer until they were replaced by the SG-38 in 1938.

## Pared to the minimum

With its simple wire-braced rectangular wing, a 'two-dimensional' framework fuselage, a wooden box-type spar as a carrier for an open seat and a skid acting as a damping element underneath, the Zögling pared the designation "aircraft" to the absolute minimum. It did, though, offer quite good crash protection for the pilot.

Serial production started in 1927 by Alexander Schleicher in his factory at the foot of the Wasserkuppe, and among the early customers was the Hungarian Aeroclub. Although none of the original machines have survived, Hungarian vintage enthusiast Laszlo Revy decided to commemorate the 70th anniversary of the Aeroclub by building a replica from the original plans. He also managed to certify it for bungee launching, autotow and even aerotowing. During a

VGC Rally in the Czech Republic, he offered me the chance to fly his precious machine.

Settling onto the small seat (it's a plank and don't trip over the wires as you get 'in') I immediately realised for whom this glider had been designed – only a 14- to 16-year-old would find a comfortable position. My 1.8m height meant that I had to fold myself in between the pedals (a simple bar, rotating around a central axis with leather straps to secure your feet) and the backrest. Although there are proper straps to hold you in, I noticed a leather loop above my head; this is a 'psychological' handhold for the left hand when bungee launching.

While going through the minimal checks I noticed that neutral elevator (the control movements can easily be seen from the seat) positioned the stick well forwards. This turned out to be a precaution to prevent its injuring the pilot's face in a crash.

For car- and aerotowing, the 'modern Zögling' has a towhook next to the original, open bungee hook. A further modification to the 1927 standard is Laszlo's small instrument panel which contains an ASI (very sensible, as we'll see later) and a vario (Laszlo actually soars this machine). An altimeter isn't necessary – just look down to see how high you are!

On an aerotow Laszlo uses a long 80-metre cable. There's a good reason for this: with the centre of the aerodynamic forces close to the high wing level, and the attachment point of the cable being very low, horizontal tow cable tension produces a tail-heavy moment. This has to be compensated by 'down elevator' during an aerotow on a short rope. Using a long towrope, you can

fly higher than the tug (which you usually should never do) which allows the cable to pull down the nose helping the Zögling remain longitudinally stable even at an airspeed of 85km/h. This high tow position doesn't pull up the towplane's tail too much because the cable forms a bow. During the initial part of the launch, the glider can also climb quickly above the propwash.

The tug for my flight was a big, early 1950s Czechoslovakian L-60 Brigadyr, a four-seat STOL aircraft, something between the WW2 German Fieseler 156 Storch and the post-war Dornier Do-27. It looks huge and heavy, but was the slowest tug available.

As the Brigadyr took up the slack, the elastic tow cable stretched and then we quickly became airborne; the feeling was much like that of a bungee launch. Anxious not to climb too high, I pushed the stick forward a bit too much and dropped into the powerful prop turbulence. With a wing trying to drop I needed full rudder for some time to get it level again. I used only little aileron because I feared its large drag might have made the situation worse.

Climbing back into the clean air, the Brigadyr laboured in front and below with the very high angle of attack necessary to give me a slow airspeed of 80 to 85km/h. As we climbed each little gust increased the tension on the cable, resulting in the Brigadyr's tail being pulled up a bit and requiring continuous elevator work by the pilot to keep the speed constant. To make his life easier, I tried to fly as low as I could without losing too much longitudinal stability myself. As I pulled off at 800 metres he turned back to get a close look at the crazy flying chair and I could wave my thanks!

While I still had height I wanted to test the Zögling's stalling characteristics. Down to 50km/h, it flies and reacts normally, as you would expect it from a good trainer of the time. Below 50km/h, the stick started to feel spongy, but the glider continued to fly with normal reactions to control inputs and but there were no further stall warnings. As the ASI reached 45km/h things changed very suddenly: one side of the rectangular wing



*Pared to the minimum (don't even think of sideslipping) and yet thousands of youngsters learned on the Zögling*

stalled, dropping very quickly and giving me the impression of standing vertically in the sky. Although I have spun many gliders, I couldn't believe the feeling you get when you do it in an open primary; it's so hard to describe you just have to experience it!

### Sudden wing-drop

During the wing-drop, I had applied opposite rudder and eased the stick forward so the rotation stopped after less than half a turn – but it felt a whole lot longer – and I eased out of the dive without gaining much speed or losing much height. It was at this point that I understood why many old photographs show primaries with their noses stuck in the ground after failed bungee launches...

Fortunately, speed and height were usually low when the wing-drop happened, so most pilots were not seriously injured. Wingtip washout to prevent sudden wing drop when stalling wasn't introduced until about ten years later. The SG-38, for instance, has a very gentle straight-on stall, resulting in only light damage when the much better sprung

and damped skid hits the ground. Flying the Zögling in the 'normal' speed range, between 55 and 65km/h, it flies agreeably and reacts well, but you need big, unambiguous control inputs. The small corrections we make in today's gliders are simply ignored by the primary. But this is the way things had to be back then because, with the single-seater instruction method pupils on their first flights would have lost control of a machine which responded to each little control input.

Aileron movement created lots of drag at slow speeds, more than the small, all-moving rudder could compensate for. Differential aileron movements to reduce this effect, where the 'down' control surface has less deflection than the one going up, did not become common until 1934. You could also clearly feel how each control movement killed the glider's performance, so I tried to use them sparingly.

With no thermals about to try the soaring ability, it soon became apparent as I looked below that it was time to think about landing. Given this machine's performance, or lack of



*Leather straps hold the pilot's feet on the rudder pedals; instruments are not standard All-moving rudder is too small to compensate for the large amount of aileron drag*

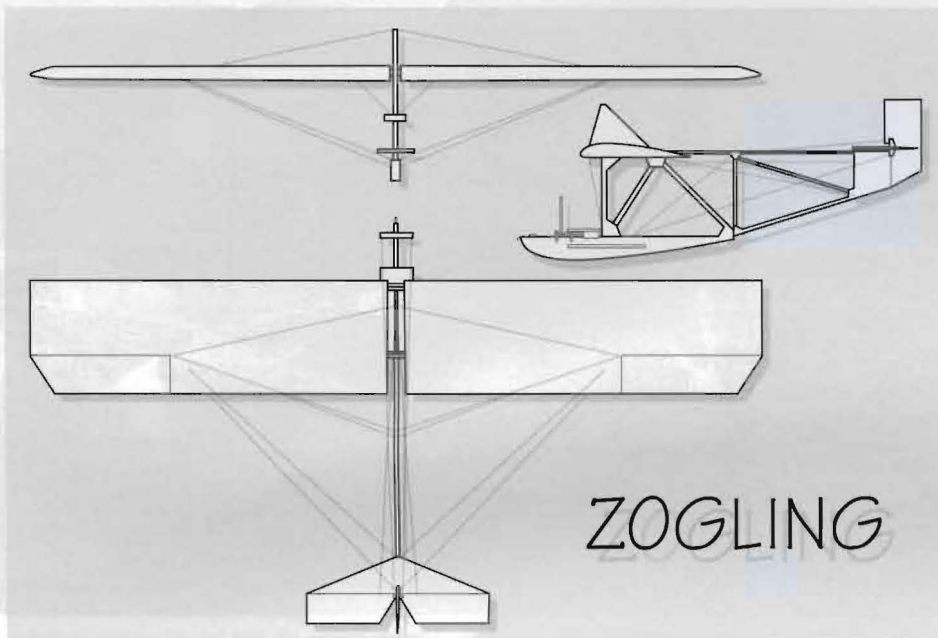

Steve Longland

it, the circuit would have to be along the airfield perimeter. On base I reckoned I needed to increase speed to 70km/h before turning on to final, and I would S-turn to lose what surplus height I had. I could have sideslipped, but I got the impression that the open fuselage framework would result in absolutely no drag increase.

The easiest way to get a Zögling down is to push the stick forward a little: the slightly increased speed raises the airframe drag so much it's like having airbrakes. I reckoned it would be best to keep this steep attitude until almost on the ground because the unobstructed view from the pilot's seat can make you flare too soon – and I certainly didn't want to add a new Zögling crash photo to the many historic ones...

Close to the ground I levelled off and the skid touched softly, bringing us to a halt after a short slide. Stopping doesn't mean the flight is quite over, though, as the pilot has to

suppress the reaction to put a foot on the ground to try to prevent the wing going down. Instead, when the stick has to be moved towards (not away from, as the usual reaction would be) the dropping wing to prevent the aileron tip being damaged by the ground. Care has also to be taken when opening the harness lock – if you forget to hold onto the seat or the leather handle, you are be dumped unceremoniously beside the glider in front of a smirking retrieve crew!

Although the Zögling isn't as 'perfect' as later primaries such as the SG-38 (also built in GB as the EoN Primary) or the British Slingsby T-38 Grasshopper, this glider appears to have been a safe and easy to fly trainer for its time – as long as you keep the speed up and are aware of how quickly it loses height. If you ever get the chance to try an old primary, do it and join the thousands of others who learned to fly this way. Thanks, Lazlo for the opportunity.

## Fransois Van Haaff, who is the Technical Officer (Airspace & Equipment) of the European Gliding Union, gives a simple, Europe-wide view of the pros and cons of transponders

**T**O START OFF with a bit of history: transponders, the airborne part of Secondary Surveillance Radar (SSR), were first developed to enhance primary radar. Primary radar, which we all know from its impressive antennas seen rotating at airports (for approach control) or sometimes in the middle of the countryside (for long range surveillance) was developed during World War Two.

Strong pulses in the order of a mega-Watt, bundled in a narrow beam, proved to be reflected by aircraft. This gives a weak (but strong enough) signal in the radar receiver, which is turned on immediately after each pulse has been transmitted and which obviously uses the same antenna to "hear better". The azimuth (geographical direction) of the antenna and the time interval between transmission of each pulse and the reception of the reflected energy determine the azimuth and distance of the aircraft.

Unsurprisingly, this works well with Boeing 747s, but the metal and wiring in gliders often reflect enough energy to let the glider show on the radar screen as a "blip" as well.

This is fair enough, but there are two important things missing. One is the identity of the aircraft, the other is its altitude. During World War II, therefore, IFF (Identification Friend or Foe) was devised, later developed further for civil applications as "SSR". A military version with special functions is still extensively used as IFF.

Primary radar is a passive system, because the weak reflections on the skin and other metal parts of the aircraft are detected on the ground. SSR transponders actively reply to interrogations with relatively strong pulses of up to 500W. Apart from the information contained in the reply pulses, these relatively strong signals give a much better radar picture. In almost all modern radar systems, the primary and secondary radar returns are detected, combined and tracked in sophisticated algorithms, so that, for instance, the heading can also be derived and shown on the screen. Previously, the controller had to either ask the pilot for his heading or watch the afterglow of the blips on his screen.

### Modes

All interrogations are made on 1030 MHz, all replies on 1090 MHz. There are four ways of interrogating, called Modes. When interrogated in Mode A an aircraft is asked for his identity, when interrogated in Mode C he is asked for his altitude. The Modes B and D are not used. The civil Mode A coincides with the military Mode 3. That is why Mode A is often called Mode 3/A.



Building a primary glider, almost certainly a Zögling, at Beacon Hill Aerodrome in Essex in 1936

# Good or bad?

The replies are called Codes. The Mode A Code is set in the cockpit in four digits, the Mode C Code automatically transmits the altitude, with 1013.2 hPa as the reference pressure, just like in Flight Levels.

Coupling a dedicated Mode A Code to a flight plan allows the controller to see the callsign of a particular aircraft directly on his screen. Mode C does the same for him with the altitude. Together with the heading, derived from the tracking algorithm, we have now enormously improved the information available to the radar controller on his screen. This explains why transponders without Mode C can no longer be accepted. We also begin to understand why controllers don't like to give clearances to aircraft (including gliders) that do not carry a transponder.

In motorised aircraft the altitude is usually derived from the altimeter (independent of the altimeter setting) or from a separate altitude coder, the so-called blind encoder. The Light Aviation SSR Transponder (LAST), which we will discuss later, has its own, built-in altitude coder.

There is now a new development, called Mode S. The 'old' Mode A/C has a few problems. Because of increasing commercial traffic (doubling in about 15 years) there is now a lack of Mode A codes. Also, the 1090 MHz reply frequency is becoming saturated, with two typical subsequent problems: garbling, which means that the reply pulse trains from more than one aircraft upon one interrogation may overlap, sometimes causing confusion, and 'fruit', replies received on the ground from transponders that were interrogated by other interrogators on the ground. The garbling problem has been amply shown during tests in France.

Mode S will solve this. In Mode S (S for selective) every aircraft has its own address – the so-called ICAO 24 bits address – so that every aircraft can be interrogated individually. When all are interrogated one after the other via their own address, there will be no 1090 MHz saturation problem any more and the code shortage, garbling and fruit problems will be over.

In its Elementary Surveillance mode, which applies to VFR flight, basically the real callsign (rather than a four-digit code) will be transmitted, plus the altitude. In Enhanced Surveillance, for commercial traffic, a lot more data are transmitted.

All this will improve the radar picture enormously again. It will be clear that Mode S is sensible and inevitable, at least in the so-called "Core Area" of Europe (Belgium, part of England, a part of France, Germany, Luxembourg, the Netherlands and

Switzerland). It means a new generation of transponders, yes, and they will be more expensive, but not that much.

Mode S transponders automatically function like Mode A/C transponders when interrogated in Mode A/C, so Mode S transponders include A/C functionality. All in all, Mode A/C transponders will soon be outdated in the core area of Europe. They should no longer be bought there.

The dates from which Mode S transponders are mandatory are published in national AICs, but generally speaking March 31, 2005 is the date for new installations across Europe (but UK readers should also see the section about transponders in Carr Withall's article, *Gliding and UK Airspace*, on p42). Existing Mode A/C transponders may in general be used until March 31, 2008. A Eurocontrol specimen AIC gives guidelines. Most national AICs can be consulted on the various Civil Aviation Authority (CAA) websites. The Eurocontrol specimen AIC can be consulted on the Eurocontrol website, in the context of the Mode S programme.

## ACAS

Before we go on, another consideration must be mentioned: the Airborne Collision Avoidance System (ACAS). The American production version is called Traffic Collision Avoidance System (TCAS). The latest version is TCAS-7. Aircraft equipped with ACAS (most IFR flying/commercial aircraft) interrogate all aircraft with Mode A/C or Mode S transponders in their vicinity, deriving a picture from this and warnings when their own trajectory is in conflict with the trajectory of another aircraft. If necessary, firstly a Traffic Advisory (TA) warning is generated. Secondly, and only if necessary, this is followed by a Resolution Advisory (RA), advising the pilot to climb or descend. Although ACAS sometimes gives alarms unnecessarily, it has proven its worth as a back-up to Air Traffic Control. A typical example is an aircraft 1 that descends to FL230 while aircraft 2, on an opposite heading, climbs to FL220, but overshoots that level. The pilot of aircraft 2 may react in time, but a warning here may save lives. A problem with ACAS shows when there is VFR traffic below a busy TMA. Aircraft in that TMA may well be cleared to descend to the lowest level of the TMA, below which there may well be VFR traffic. In practice, so many false alarms are triggered that sometimes the VFR traffic is asked to switch its transponders off.

ACAS also works with Mode A/C and even better with Mode S transponders. One can imagine that it is sensible for VFR aircraft in

an environment with dense IFR traffic to carry a transponder. This may happen typically in Class E airspace. What must be done then is to analyse where and when the IFR traffic density rises above an acceptable level. Our authorities seem reluctant to make such an analysis. The good old "see-and-avoid" principle will do in the rest of the airspace concerned. It is questionable, to say the least, whether this should also apply to fast military jets.

ICAO Annex 6 states in 6.19: "All aeroplanes shall be equipped with a pressure-altitude reporting transponder which operates in accordance with the relevant provisions of Annex 10, volume IV." We note here that this refers to aeroplanes, not gliders. A note states: "This provision is intended to improve the effectiveness of air traffic services as well as airborne collision avoidance systems." That is fair enough, but far too general to let it apply to gliders in all Class E airspace, for instance. To do that, a good analysis of the situation is justified.

## What about suitability for gliding?

That depends. There are several factors to consider, like size and cost, especial in cases where there is only the usual 7 Ah battery and little room. EUROCAE, the European organisation for airborne equipment, has laid down specifications for the Light Aviation SSR Transponder (LAST). The EGU helped to draw these up. Several firms are working on LASTs (as of February 2004) and one firm, Filser, is marketing its TRT-600. It must be remembered that developing a transponder is one thing, having it certified to a Joint Technical Standard Order (JTSO) of the JAA (soon EASA) is another. Details of the Becker, Dittel, Filser and Garrecht products can be found on their websites.

The LAST is an ICAO-compliant Mode S transponder of a small size (usually with the standard 57mm diameter front). The specifications allow three versions: a fully portable one, a version for cradle mounting (where several gliders can have cradles and wiring for a limited number of transponders, as can be done with some VHF radios), and a version for fixed mounting. The LAST also has a low power supply capacity warning system.

The cost of the LAST is in the order of EUR 2500, an antenna EUR 200, ex VAT. However, we must not forget the cost of installation, depreciation and especially the yearly or two-yearly technical check. Technical checking is a special job with special equipment, which is not cheap. There are plans for so-called ramp test units, which can be used by approved glider radio

technicians. One ramp test could be used by specialists from several clubs. The firms which develop LASTs are aware of this problem. For the time being, professional firms will have to be asked to do the checks on the spot or to do bench tests (with the transponder out of the glider) in their offices. In the latter case, usually a separate check of the wiring must still be done in the glider.

There are other aspects, too. First of all, there is the question of the optimal positioning of the antenna. A transponder, like any transmitting/receiving device, only works properly with a well-placed antenna. That will normally be at the underside of the fuselage because of 'visibility' for surveillance. The best place is supposed to be determined by the manufacturer of the glider and to be tested in the air, but up to now (February 2004) only DG provides antenna-mounting instructions. Be aware that a transponder antenna, which is about 8cm long (dependent on the type), may protrude far enough below the underside of the fuselage to be damaged when the fuselage is rolled into the trailer.

Then there is the question of the influence of radiation on the human body. The antenna will normally be one or two meters away from the body of the pilot(s). Experience shows that it is very unlikely that harm is done. Fortunately the average power transmitted is only a fraction of a Watt.

Last but not least, there is the problem of power consumption. As long as Mode S is not universally used, the number of interrogations will remain high or even very high, depending on the number of radar stations on the ground. A high interrogation rate means a high reply rate, and thus a high power consumption. In the core area of Europe this will often be the case, resulting in a current drawn of up to 1A at 12V. It goes without saying that our batteries can't stand that for very long. The interrogation rate should go down drastically, however, after Mode S has been fully introduced (2008)? Often solar panels are mentioned, and they can help, but they are unable to deliver 1A as yet. Also a really flush mounting is next to impossible, let alone when one considers types like the good old K-6.

## Operational aspects

We all know how airspace available for cross-country gliding – and even to local soaring if you happen to live in a bad spot – is closing in upon us. In short, it can be said that priority is given to commercial traffic. The air forces are not even such a problem, because they want to continue to be allowed to fly relatively low and VFR.

A typical trend is the conversion of Class E airspace into Class D or even Class C "to protect IFR traffic better". First of all we must query the size of new, upgraded airspace. Next we must make sure that we can have access to all Class D and Class C airspace by asking for a clearance. If such clearance is bluntly refused, which unfortunately happens, we must file complaints via our



Fransois van Haaff at the EGU Congress this year

national organisations. We must understand, on the other hand, that an air traffic controller who is responsible for a fair amount of IFR traffic will only be able to give a clearance if we carry a transponder, and we must also understand that gliders are a difficult sort of VFR traffic. We rarely maintain a heading or an altitude.

Things become different when controlled airspace concerned is limited in size. In that case we will be in that airspace for a limited amount of time, and normally on a fairly predictable path. As long as we are competent in our R/T there need not be any problem, and the transponder needs to be switched on only for an equally short time.

There are other possibilities. The German idea of the Transponder Mandatory Zone (TMZ) is a good compromise, for instance. No clearance is needed to cross a TMZ (so no R/T) as long as the transponder is active. This solution typically applies to less busy CTRs and TMA's. Then there is the Swedish idea of blocks of airspace that can be opened upon a telephone call. A last, good possibility is to agree on areas that only require a clearance or just a transponder (the TMZ principle) at certain times. This typically applies to some military areas.

All these aspects must be discussed with the national authorities. Sometimes the authorities are politically driven, so that they don't want to listen. Here only patience may help.

The last aspect is our own interest in carrying a transponder. Since the Montpellier (France) "mid-air" (see December 2000-January 2001, Collision at Montpellier, p29) many glider pilots realise that a transponder a) helps you to be seen by ACAS-equipped IFR traffic just like an electronic strobe light, and b) to obtain a clearance where that normally is refused.

## Looking to the future

A promising new system is coming: ADS-B (Automatic Dependent Surveillance-Broadcast). In ADS-B aircraft transmit their own positions, as derived on-board (so not via radar on the ground) to all who are interested, including ATC. One can imagine that this is ideal for well-equipped aircraft

over areas where there is little or no radar coverage. Because we often have GPS already, one would think that this is ideal for us too, but as usual there are practical problems.

The first one is the data transmission medium. There are three basic possibilities. The first one, VDL-4 (VHF Data Link type 4), uses VHF channels, the second, UAT (Universal Access Transceiver), uses frequencies in the UHF band, and the third uses the Mode S reply frequency of 1090 MHz, in what is called 1090 Extended Squitter (1090 ES). In the first case, some VHF channels are used for the ADS-B data link. Apart from the shortage of VHF channels (that is why the new 8.33 kHz system is being introduced) we will not readily accept another generation of equipment on board after we have been obliged to accept transponders. UAT is not compatible with the European frequency allocation system. 1090 ES would be the simplest system to accept in this respect, but it would mean a serious addition to our LAST. Then there is the fact that ADS-B via VDL-4 or UAT is not compatible with ACAS. No, interesting as it seems, ADS-B is not for us now. Still its developments deserve to be followed closely with regard to the future. We are doing that in Europe Air Sports and the EGU.

What is closer to us, and a simple addition in principle, is the possibility to let our LAST transmit ('squitter') our GPS co-ordinates for tracking purposes during competitions. This possibility is known in the industry. It is a subject that is being followed up. It would make the LAST a lot more acceptable to us.

## Abbreviations and acronyms

ACAS	Airborne Collision Avoidance System
ADS-B	Automatic Dependent Surveillance-Broadcast
AIC	Aeronautical Information Circular
ATC	Air Traffic Control
CAA	Civil Aviation Authority
CTR	Control Zone
EASA	European Aviation Safety Agency
EGU	European Gliding Union
ES	Extended Squitter
EUROCAE	European Organisation for Civil Aviation Equipment
GPS	Global Positioning System
IFF	Identification Friend or Foe
IFR	Instrument Flight Rules
JAA	Joint Aviation Authorities
JTSO	Joint Technical Standard Order
LAST	Light Aviation SSR Transponder
RA	Resolution Advisory
SSR	Secondary Surveillance Radar
TA	Traffic Alert
TCAS	Traffic Collision Avoidance System
TMA	Terminal Area
TMZ	Transponder Mandatory Zone
UAT	Universal Access Transceiver
VAT	Value Added Tax
VDL	VHF Data Link
VFR	Visual Flight Rules
VHF	Very High Frequency

S&G thanks Francois/the EGU for letting us use this article

## Lots of reasons to give us a

- Centrally Located
- Good Cross-Country Opportunities
- 4 Drum Winch / 6 Onsite Tugs
- Modern Fleet of Gliders
- Modern Briefing Rooms
- Modern Bar & Restaurant (Open for evening meals\*\*)
- Good Onsite accommodation (single rooms available)

# try...



## Visitor Offer

for every party of 6  
1 visitor will get  
all their meals  
**FREE\***

### FREE MEALS

[www.thesoaringcentre.co.uk](http://www.thesoaringcentre.co.uk)

**Tel: 01858 880521**

**e-mail: [office@thesoaringcentre.co.uk](mailto:office@thesoaringcentre.co.uk)**

Husbands Bosworth Airfield, Lutterworth,  
Leicestershire LE17 6JJ

\* Only 3 meals a day from our set menu from our restaurant.  
All visitors must be flying members.  
\*\* Summer season only

## Santa Cilla Airfield. Jaca. Spain.



# thermals on sale here

Mountain flying courses. Impressive landscape. Family-friendly environment.

[www.jaca.com/aerodromo](http://www.jaca.com/aerodromo)

[aerodromo@jaca.com](mailto:aerodromo@jaca.com)

**+34 974377610**

# TAIL FEATHERS

by Platypus



## Soaring up the learning curve

ONE of the most educational experiences of my gliding career was in 1988 when I did the same modest 170km triangle twice in the same afternoon: once with a Lasham friend who came along for the ride and who was far too polite to offer any criticism, and once with Brian Spreckley, whose criticism I urgently desired. At this stage I had owned the ASH 25 for a few weeks and was getting used to the new toy. Brian had only the previous year become World Champion in the 15 m Racing Class; his morning master-classes at le Blanc should have been turned into a video or a book. You can indeed learn a lot at a desk, but there is no substitute for being in the air with the guru.

### Pining for parana

The first thing Brian told me was that I was thermalling the ASH 25 "like a wooden glider." I was flying fractionally above the stall. Modern plastic needed to be flown faster; if I banked at 45° in bubbly air I needed 55kt. This speed felt disgustingly fast to one brought up on parana-pine plywood, but I was a lot less likely, upon hitting a negative gust or patch of sink, to be waffling in a semi-stalled state, with the ailerons barely biting the air, for several seconds – during which time the core of the thermal had slipped by and sneakily hid itself somewhere behind my left armpit. I was also more likely to be welcome in future competition gaggles if I could keep the glider unstalled, and under control, at all times.

Moreover I had for 30 years slavishly followed *The Soaring Pilot* by Ann & Lorne Welch and Frank Irving. Written in the days when Skylark 3s and Olympias were the best soaring machines one could buy, the first edition of this great work enjoined us to centre by straightening up completely for a few seconds on specific headings which would shift the circle towards the core. Now, with 84 feet of heavy wing, it took a lot of effort and time to level the wings from 45° to 0° then whack it back again to 45°. Over several hours it would get tiring. It was better to make smaller changes in bank – 20 degrees or so, and to tighten up

as one passes the core, while easing off bank as one feels the lift increasing. The Helmut Reichmann book *Cross-country Soaring* described that more modern method. At steep angles of bank, the tightening and easing-off is largely done by the elevator anyway, and that is less tiring than massive changes in the angle of bank.

When I examined the statistics from the Peschges flight-computer – nothing so

### A turning-point in my thinking

comprehensive as the stuff one gets from GPS loggers today, I am afraid – I found that although I deviated much further from track on the second tour, my average rate of climb, cross-country speed and achieved glide angle were all about 20% better.

Of course, the day could have been improving since my first time around the triangle, but I don't think that was it at all. At one point I was driving along in a determined fashion past a buxom blonde cu-nim with a very dark, firm bottom (a bit like one of Beryl Cook's cheerful ladies) and Brian said, "How much do you think the cloud over on the right is generating?"

### Postscript: Some diverting numbers

LATER on I did some calculations about how strong a thermal you needed to make a given amount of diversion from track acceptable. I worked on the finding that I collected over many years, that achieved cross-country speed is more or less proportional to the square root of the average rate of climb. So if Fred climbs three times faster than Pete his cross-country speed will be 70% faster, the root of three being 1.7. That assumption, combined with a spot of schoolboy trigonometry, gives us a simple table. (It also incidentally justifies the common practice of squaring the cross-country speed when calculating speed points in competitions.)

Here are some sample results:

\* If the thermal off to one side is 50% better than what you expect to get by going straight on, then a deviation of 35° is worth while

\* If the thermal off to one side is twice as good as what you expect to get by going straight on, then a deviation of 45° is worth while

\* If the thermal off to one side is four times as good as what you expect to get by going straight on, then a deviation of 60° is worth while

"I dunno, maybe six knots"

"Then why aren't we using it?"

A very reasonable question, since the overall average so far had been not much above 3kt. So I diverted over to it and sure enough, got a healthy 6kt to cloudbase.

I had been fixated on sticking to track and, Scrooge-like, begrudged the loss of cross-country speed incurred by any deviation of much more than 15°.

Best of all, in those two hours Brian made me use my brain harder than I had done on any cross-country before. Since the first turning-point was the town of Descartes – which as you all know is the name of one of the world's greatest thinkers – that was only appropriate.

This season, try to scrounge a cross-country in a two-seater with fellow-club-member who is a lot better than yourself. If it's someone articulate who can explain what the choices are and why decision X is preferable to decision Y, you're in luck. Go for it.

Just one piece of advice: if things go pear-shaped and you land out, don't ask the expert as you undo your harness, "Jim, what exactly would have been so wrong with decision Y?" Nobody's perfect, and it could be an awful long wait.

You might say the occasions that justify a deviation of 60° must hardly ever happen – but they occur constantly in these wet and windy isles. When the very best you can expect if you press grimly ahead is half a knot, then that shy little two-knotter hovering on the periphery of your field of vision suddenly becomes a ravishing beauty – or that is how you ought to see it. As Einstein (I'm mixing in exalted company this month) said, "It's all relative!"

deviation from track (°)	improvement in rate of climb required (%)
10	3%
15	7%
20	13%
25	22%
30	33%
35	49%
40	70%
45	100%
50	142%
55	204%
60	300%
65	460%
70	755%



follow four- and six- lane highways

## No-brainer navigation or Follow that pigeon!

When I went to an Ancient Seat of Learning I read Philosophy and British Constitutional History and heavy stuff like that. So I was enormously envious when I discovered that if I'd gone to a German university I could have been designing, building and flying gliders as part of my academic grind. (I suppose if you fail your degree they just shovel earth over the hole.) Now I am delighted to hear that Oxford is catching up and having aviation-related fun, no doubt at the taxpayer's expense. A group of scientists at the Zoology Dept have spent 10 years discovering that our pigeons don't navigate by the sun, but prefer to follow four- and six-lane highways.

Don't bring up the obvious fact that we have no sun in Britain. That would be regarded as a frivolous exercise in point-scoring – apparently bees navigate by polarised light so they can work out where the sun is even when it's cloudy; pigeons should have bigger brains than bees - though one wonders sometimes - and should be able to locate the sun's position despite thick overcast if they wanted to. But they don't want to. They prefer a road, even one that takes them 20% further than they need to go. Which goes to prove my thesis that intellectual laziness is much more powerful force in our lives than physical sloth. Almost any torment is better than having to think. Or they have worked out a little table like the



breeding of homing vultures

one opposite, in which the key variable is the saving in brain-pain.

What is remarkable is that each pigeon in these tests carried teensie little GPS with loggers and batteries – the total weight of the machinery being 18 grammes, or less than two-thirds of an ounce. My first GPS and logger, bought from Zulu Glasstek in 1992, weighed 30 times more and would have needed a vulture in fighting (ie pre-lunch) trim to lift it.

*I say, the breeding of homing vultures would be a hobby to make the neighbours think and get yourself talked about, would it not? But I digress. (Yes, you do; get on with it – Ed.)*

I am currently trying to find out how they – the scientists, not the pigeons – miniaturised all that kit. I assume it cannot have been too expensive, since they equipped 50 birds in this fashion, and some of it was bound to go astray. On the other hand perhaps it really was expensive and helps explain why Oxford's finances are so dire.

This story of pigeons' amazing abilities was slightly spoiled by the simultaneous reports of two British birds (not among those equipped with GPS loggers, sadly, since their traces would have been sensational) going vast distances off track: one of them was found wandering around an army base in Iraq, which was not its destination; the other, quite unable to find England when released just 21 miles away at Calais (not an insuperable task – even I could do that on a clear day) ended up in New York, and after making a big hit with the local media came back on British Airways. Strangely neither of them responded when addressed as "JJ."

What has this got to do with the noble art of soaring? Well, not a lot, but a Professor Allen wrote to *The Times* immediately after the Oxford report came out in that distinguished organ (which, by the way, the Americans have the cheek to refer to as *The London Times*) and said that in his opinion the pigeons were using the M1 not to navigate but as a source of thermals, which were set off by great quantities of asphalt and concrete. This was too good an opportunity to miss, and I fired off a pithy missive to the Editor of *The Times* as follows: *It is unlikely that pigeons use motorways as thermal sources rather as navigational aids. Pigeons flap and fly straight; they don't soar. In 5,000 hours' gliding, I have found motorways of little use as thermal generators. Lastly, the GPS traces you printed on February 5 clearly show one pigeon following a railway line for some distance, and railways are even less use than motorways as lift sources - though they might have been in the days of steam!*

*The Times'* Editor kindly printed this piece of pith, but left the exclamation mark off the end. The "!" had been intended to show that my tongue was in my cheek as I penned the last sentence. However. I did not get any counter-correspondents writing in to complain that a steam locomotive could not possibly generate enough heat to fund a



subscribers had read quite enough

usable thermal, or others saying it might nevertheless kick one off on a hot, still day, and yet others saying that that would be due to the motion of the train and not the steam, and yet others remembering distinctly seeing a movie called *Cloud Cuckoo*, in which Wilbur Sparrow soars from Unstable GC over to Africa, using the steam-clouds from ocean liners – forgetting that it was only a cartoon by the brilliant London GC member Lawrence Wright. But not a word came. The Editor had clearly decided that his subscribers had read quite enough about pigeons – and so have you.

[mdbird@dircon.co.uk](mailto:mdbird@dircon.co.uk)

*The Platypus Papers: fifty years of powerless pilotage* (hardback, 160 pages, 100 Peter Fuller cartoons) costs £19.95 + £3.50 p&p. tel 0208 748 6344 or buy securely on line at [www.gliding.co.uk](http://www.gliding.co.uk)



# BGA in a changing world

**This year's conference, in the Association's anniversary year, was the last one for long-serving Secretary Barry Rolfe. Helen Evans reports**

**M**ORE THAN 300 people attended the AGM and Conference held at Eastwood Hall, Nottingham, on March 6-7, in the BGA's 75th year. This was about the same number as last year, though two familiar faces were missing: gliding's Parliamentary spokesperson, Lembit Öpik MP, who had to attend a Liberal Democrats Party Conference, and BGA Vice-Chairman Mike Jordy, absent for family reasons. A reminder of the shrinking world that we live in was provided by the presence of delegates from all over Europe, attending the European Gliding Union's (EGU) Annual Congress.

BGA Chairman David Roberts opened proceedings at 10am with a warning. "We are living in interesting but also difficult times," he said. "There are lots of developments in the regulatory framework of our sport. The fundamental purpose of the BGA since it was reconstituted in 1946 has been self-regulation. But more and more the role of the BGA is changing in terms of national and international activities. We need to recognise that this role is absolutely crucial if gliding is to survive as a viable sport."

Having praised the performance of the British Team and called attention to Barry Rolfe's impending retirement, David appealed for more national-level volunteers with the time and expertise to help the movement. He then handed over to BGA Executive member John Birch to run the rest of the morning's programme, as he had to take part in the EGU meeting.

The first speaker was Mike Woollard of the Faulkes Flying Foundation, a charity that aims to develop young people through flight training. (*S&G will feature its work in a future issue.*) Then followed a session run by John Birch and Stephen Hill seeking club input about the BGA "back-up" policy for inspectors/instructors – a questionnaire on



the subject is to be circulated to clubs. Then Peter Eriksen of the EGU explained some of the issues facing the sport in Europe. The morning concluded with a presentation from the current chairman of the instructors' committee, Bob Pettifer, and former BGA Chairman Dick Dixon on the future of the BGA coaching operation.

After lunch came the formal business of the AGM for the year ending September 2003. The minutes of the previous AGM were approved, as were the Chairman's and sub-committee chairmen's annual reports; accounts for 2002-3 were also approved. They showed a surplus of about £79,000 as compared with the previous year's deficit of £159,000 (due to a one-off cost that is now fully provided for, said treasurer Keith Mansell). There had been an improvement of about £6,000 in income and a reduction of about £25,000 in expenses. The budget for the year starting October 2004 was also approved with an increase of per capita BGA subscriptions of about three per cent above the current year. Other increases were pegged at inflation, but a larger-than-usual contingency fund was planned because of the unpredictability of changes in role that

might be forced upon us by the European Aviation Safety Agency. "We are conscious," said David Roberts, "that the trend of the BGA's role is likely to be changing in this budget period if not before. We do need flexibility and we might need to call an Extraordinary General Meeting to seek support for changes we would be proposing if they are outside a normal financial flight envelope". King Freeman & Co were then reappointed as the BGA's auditors.

There followed the election of officers: David, the only nominee, was re-elected Chairman; no elections were required for Executive membership because the number of places exceeded the number of nominees. New faces are Ted Norman of the RAFGSA and Richard Starey of Booker. Re-elected to join David, Mike Jordy, Paul Hepworth, Doug Lingafelter, Patrick Naegeli, John Birch, Keith Mansell and Barry Rolfe on the Executive Committee were Diana King and Jon Hall. The BGA Vice Presidents – Chris Simpson, Roger Barrett, Ben Watson, Bill Walker, Don Spottiswood, Dick Dixon and Peter Hearne – were re-elected.

David thanked Philip Burton, Terry Slater and Claire Emson, who had left the Exec, for



Pete Stratten will be the BGA Chief Executive from May



Ted Norman of the RAFGSA has joined the BGA Exec



Richard Starey from Booker is a new Exec member



Left: EGU delegates at Nottingham in March this year

Above: Ted Lysakowski Trust winners with (front row, right) Steve Jones, who presented the awards: Jerry Pack, Anthony Claiden, Ian MacArthur, John Gilbert and Jon Meyer. Sarah Platt, another winner, was absent  
 Right: BGA Trophy winners (from left) Hugh Kindell (who was collecting one on behalf of a friend); Rod Witter, Richard Hood; Geralyn and Tim Macfadyen; Peter Baker and John Birch. Front row, from left: Jez Hood and Andy Davis, both current world champions



all their work and referred to Barry Rolfe's enormous contribution to the BGA (see also p4) before handing over to Chris Simpson, senior Vice President and the first Chairman that Barry worked for. Chris pointed out that Barry had arrived at the BGA just as the first fibre-glass gliders appeared on the scene, and supervised the Association's move from London to Leicester – he had seen many changes at his time with the BGA: "Barry," he concluded, "has been a very loyal servant to eight BGA chairmen, and to the whole BGA committee". Responding, Barry said the job had been great fun. "I would be remiss," he added, "if I didn't say that if you've got good staff working for you then essentially it's a doddle." (An appreciation of Barry's time at the BGA by former S&G editor Gillian Bryce-Smith will appear in the next issue). David Roberts then added that, after a proper selection process, Pete Stratten had been appointed as Barry's successor, in the new role of Chief Executive, and wished him all the best in taking up the job.

Barry then presented BGA awards (see below) and trophies (see right). One trophy not presented was the 1,000km trophy conceived and donated by Peter Hearne. He

encouraged pilots to try for it this season, saying he hoped there would be another name on it by this time next year. Yvonne Scull could not, sadly, be present, because of serious illness, but the Bill Scull Safety Award went to John Hoskins.

Ted Lysakowski Trust awards were presented before two very well-received presentations, from hang-gliding star Judy Leden and NASA astronaut Jerry Ross. The day concluded with the usual successful, full-to-capacity dinner-dance.

**Wakefield Trophy: Richard Hood (Cambridge)** For the longest handicapped distance, 756.1km in an LS8 on May 6, 2003 from Gransden Lodge to Sarnesfield, Bury St Edmunds, Winchcombe and Gransden Lodge (actual distance 756.1km). **Furlong Trophy: Tim Macfadyen (Bristol & Glos)** For the longest handicapped triangle, 623.4km in an ASW 20 on August 14, 2003 from Nympsfield to Bury St Edmunds, Doncaster and Nympsfield (actual distance 610.9km). **Frank Foster Trophy: Rod Witter (Denbigh)** For the fastest handicapped 500 km, 118.1km/h in a Duo Discus on 15 August 2003 from Bicester to Cambridge, Burley Gate, Grafham Water and Bicester (actual speed 120.5km/120.5km/h). **California In England Cup: Rosemary Johnson (Midland)** For the longest handicapped flight by a female pilot, 618.1km in an LS8 (18-metre) on June 13, 2003 from Long Mynd to Lasham, Thorne, Skeffington and Bidford (actual distance 655.2km). **Manio Cup: Rod Witter (Denbigh)** For the fastest

handicapped 300km, 118.1km/h in a Duo Discus on August 15 2003 from Bicester to Cambridge, Burley Gate, Grafham Water and Bicester (actual speed 120.5km/h). **Volker Trophy: Paul Barker (Southdown, DG-400), John Birch (Cambridge, Duo Discus T), David Saunders (Lasham, Stemme S10), Richard Hood (Cambridge, LS8)** For the earliest Diamond distance in the year. **De Havilland Trophy: John Jeffries (London)** For the maximum gain of height. **Volk Trophy: Geralyn Macfadyen (Bristol & Glos)** For the longest handicapped out-and-return, 537.4km in an ASW 20 on 13 June, 2003 from Nympsfield to Norwich and Nympsfield (actual distance 526.6km). **Seager Trophy: Roy Pentecost (London)** For the longest handicapped distance in a two-seater, 646.9km in a Duo Discus on August 15, 2003 from Lasham to Cirencester, Llanfair Caereini, Enstone, Grafham Water, Marlborough to Lasham (actual distance 659.8km). **Goldborough Trophy: Andrew Davis (Bristol & Glos) – 1st, Standard Class, Leszno – and Jeremy Hood (Four Counties) – 1st, Standard Class, Nitra.** Highest-placed pilot in recent World Championships. **BGA 1000K Trophy:** No winners. **Enigma Trophy: Edward Downham (London)** Winner of Open National Ladder, 14,782 points. **Firth Vickers Trophy: John Bridge (Cambridge)** Runner-up in Open National Ladder, 12,519 points. **L. duGarde Peach Trophy: Peter Baker (Cambridge)** Winner of Weekend National Ladder, 9,183 points. **Slingsby Trophy: Tim Macfadyen (Bristol & Glos)** Runner-up in Weekend National Ladder, 8,303 points. **Spitfire Trophy: Ian Craigie (Four Counties)** Junior ladder winner, 4,431 points. **John Hands Trophy: Harry Middleton** For services to competition gliding.

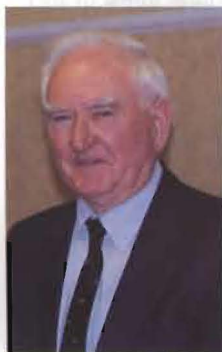

This year BGA Diplomas were awarded to (above, from left) Paul Rice, Dave Benton, Eric Boyle and Ian Barnes



DG-1000T with Volker Halbe (front) and Swen Lehner



# The way home

## Paul Barker and Guy Westgate are on the last, 2,500km leg of their epic out-and-return...

**P**AUL and I were three weeks into our glider safari, having achieved our furthest turn point, Mt Etna on Sicily; we were halfway home and hungry for some classic racing days to romp home through France.

We had cleared the Alps and slept easily at Neuchâtel on the Swiss side of the long Jura mountain range, confident that our parlous journey through the summer storms of Italy and the big mountains was finally over.

The club pilots suggested that thermals would normally start from 11:30 on the Juras and advised us to launch to at least 1,400m (4,600ft).

We started to look for signs of convection to the north, but the occasional glimpse of



fast-moving cloud tops behind the ridge didn't fit our expectations of the forecast. The wind on the field was light, determining a take-off to the east, but as soon as we were airborne the pieces of the puzzle slotted into place. Rotor was suppressing cloud near Neuchâtel, but a fearsome line of convergence-triggered towering cu stretched down the length of the mountains.

We turned into the strong westerly. As we approached the first ridge above the airfield, the wind increased; a big imaginary hand reached down and turned on the turbulence. A waterfall of angry air was tearing down the cliff edge above the L'Areuse River and bouncing up off the valley floor. Without warning the variometer swung up, hitting the stops. We shut down the engines and in no time were above 7,000ft.

The lift was short lived and in the course of the first half hour, the Juras threw us such a multifarious bag of moving air that we were confused how to keep climbing. Paul mastered the angry lift first and spiralled back into the mountains. I battled forward into the 25kt westerly to our start point looking for wave but got caught in the torrent of air and sank below the main ridge with nowhere to hide. I tried something different – a near-suicidal glide to the plateau beyond Travers. A few hundred feet above the flat fields, I found some weak lift that ballooned me over the lush agriculture until the blue touch paper caught alight and

I rode my first rocket thermal into the convergence zone.

The line of towering cu we had seen before take-off had grown fatter, and was hoovering every tiny thermal into its ugly black base. The convergence system was so powerful that it was driving its own weather pattern, with light winds aloft. Back in formation, we tripped along the mountain chain north-east, cursing the fact that the Juras and lift were both pointing away from home. The 10,000ft cloudbase and lift zone was remarkably consistent and we reached the edge of Basel's airspace before turning off the convergence motorway into the blue.

From cloudbase, we could see a solid edge of lower cloud 30 or 40km away into France. The cloudless divide was almost our undoing and after 20 minutes of gliding through sink, we reached the next cu with barely enough height to turn. The strong westerly returned with a new malevolence, thrashing every weak thermal long before



Left: Paul, Le Touquet; right, Guy in his DG (Mark Turner)



Left: Paul crossing the Channel; above: the cu-nim that tried to race Guy to Verdun; above right: a French convergence line, below: sediment lakes near Nancy

cloudbase. North of Luxeuil climb rates increased but so too did the spreadout and soon the sky was looking leaden and lifeless. The few remaining thermals carried us into a murky gloaming, past Remiremont and the Moselle River. At 4,000ft we knew we were on final glide but, unable to reach airfields in the Meuse Valley, we backtracked to Epinal and its aeroclub north of the town.

A storm was brewing and it wasn't long after we had tied the gliders down to the metal railings outside the clubhouse that the rain started. Paul (who had the dubious honour of possessing the one raincoat we shared) offered to hunt down food in the village, and returned with some soggy consolation pizza.

The weather front lingered for much of the night and the low pressure in its wake brought shreds of cloud for most of the next morning. The forecasts for airfields north and west of us were for storms with a punishing headwind. By 13:30, there was enough form in the cu to tempt us into the air but with a cloudbase only 2,000ft above terrain, the day had almost everything required for a good accident report.

We both had a rocky start, climbing straight into a rain shower and, just as things couldn't get more stressful, Air Traffic Control demanded frequency changes and almost constant position reporting. As we passed the cobalt blue sediment lakes on the river south of Nancy we found some streeting and better climbs to 4,000ft but the rain was always just a thermal away. We declared our intention to land at Nancy Malzeville where, typically, we found our first strong climb of the day. We were only an hour into the flight, and despite the wind, the chance of an improvement brought out the "push-on gremlin" in both of us.

The larger rain-bearing clouds appeared isolated and the thermal streets were well defined. We got a new clearance from ATC and pushed against the crosswind north-east. My confidence was short lived as sheets of

rain blocked every street. Paul made good progress north, but was soon calling an engine start in rain and his intention to divert to Doncourt-Les-Conflans. I dolphined into wind close to a wall of rain – so close that the military controller advised me to turn away from the weather he could see on radar. The lift was good but a blinding thread of lightning off my wingtip, followed instantly by a deafening clap of thunder, was a warning I could ignore no longer. No sooner had I levelled the wings to cross the clear gap between streets than it filled with rain and I was washed from the sky.

Paul reported that the heavy rain had reached his diversion field after landing and now the only safe option was to wait upwind for the storm to blow through. I climbed with the engine to hold but grew impatient, inching too close and getting a soaking for my troubles. As I reached the circuit, Paul advised that the clubhouse was closed and we should both fly to Verdun as soon as the rain had cleared. I ran the Rotax for the fifth time that day and climbed into the 30kt headwind towards Verdun.

A second line of storms was looming on the horizon, with one particularly large cell leading the pack and determined to race me to the field. I won the battle, but not the war, as it was all I could do to get the fuselage covers on before the heavens opened.

Verdun, too, was closed and the only protection from the rain was the airfield control room, a tiny office with a cold tiled floor. Meanwhile, Paul had better luck at



Doncourt-Les-Conflans and found a club member who gave him both hangar space and use of the comfortable clubhouse.

Paul arrived the next day in between morning showers with tales of a military operation – "Clean Hunter" – taking up large chunks of Paris and Reims airspace and grounding the aeroclubs at Doncourt and Verdun. We studied the Notams and decided the airspace limitations would make a hard day impossible, so with less than 500km to get home we took our first rest day in over three weeks.

The bar manager ferried us into Verdun and we toured the Citadelle's underground fortress, infamous from the battle of 1916. An audiovisual tour kept our interest throughout the afternoon rains. As the evening downpours intensified, our chance of finding a taxi disappeared and after an hour of asking in schoolboy French, we persuaded a café owner to drop us back off at the field.

Back in the tiny cold control room, we watched the sun set through a break in the clouds and glimpsed an aircraft silhouette tracking over the forest. We had already worked out the runway lighting controls and as the third biplane strafed the hangers, we turned everything up full to help three very grateful German pilots to land. They had taken a week touring Spain in their Kiebitz biplane microlights and they explained the storms had delayed their schedule by hours. They were truly seat-of-the-pants aviators, most of their journey flown below 1,000 ft



# TRAVELS WITH MY TOOTHBRUSH

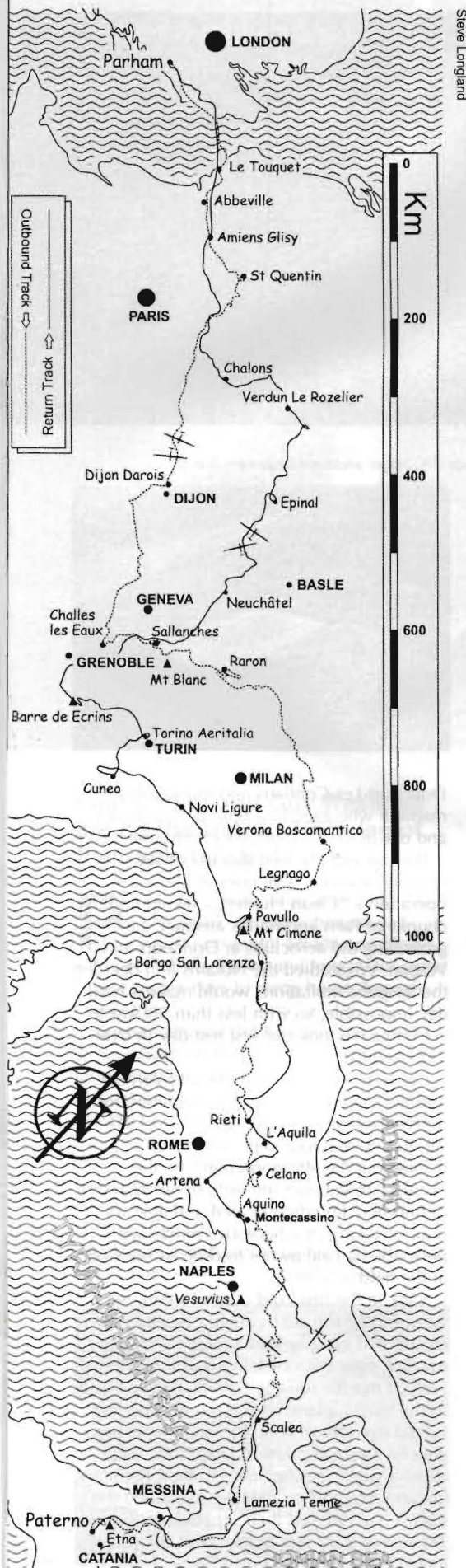

in radio silence, but had been caught out by both weather and daylight none the less.

We shared our meagre food rations and the cramped shelter with Hartmut, Helmut and Frank and followed them off the next morning into a much better, dryer sky. The forecast, becoming irritatingly familiar, was for increased storm activity in the afternoon.

We had studied the tourist map to make up GPS coordinates for Verdun's battlefields but directions were not necessary, as the huge stone tower of the Ossuaire de Douaumont appeared above the tree line as soon as we were airborne. We took a thermal over the solemn tribute to the thousands of unnamed soldiers and set off over the battlefields towards Reims.

The thermals for once were reassuringly reliable and cloudbase rose to 4,000ft until spreadout over the wooded ridges west of Verdun forced us down close to the trees. Just north, a growing line of black cu was dripping tendrils of scruffy cloud. Paul was first to find the surge of convergence lift but, as always, it looked as if it would be a double-edged sword. The climb was indeed a short-lived respite; a wall of water was bearing down on us with incredible speed. At 5,000ft we fled south. I stayed a little too long and had to backtrack slightly because arms of rain were reaching out from the maturing squall line. Three kilometres south we had a clearer picture and could see the storm system stretching to the horizon, with a well-defined skirt of convergence fed by the heavy downdrafts and outflow.

We chose to run the convergence line and cruised close to the cold grey fingers of cloud, creeping out away from the rain, and at 100kts we could run level, slowing to 80kts to climb. As we passed cloudbase, the grey figures reached out beneath us, completing three sides of a tunnel with cloud above and a fuzzy mist of rain to the north. The smooth tranquillity was punctuated only by the occasional sharp crack of lightning. It was an adrenalin-rich ride with an unpredictable ending.

As we rounded the first cell, a second and third fell into line: progress on track looked impossible. The squall line broke slightly after 50km and we rounded the back of the second cell into an amphitheatre of towering storm clouds with curtains of rain in every direction. Beneath us, bathed in sunshine, was a brilliant white line of glider trailers on the airfield at Châlons. Further progress would have been at too high a risk so we airbraked away our hard-won altitude to a fantastic welcome from the clubhouse full of rain-weary students and Jacob together with his family from Holland who had just finished flying with friends in the Alps.

We were treated like kings and left the next day refreshed and ready for the next meteorological battle. We had to make some distance: although we had less than 420km to go in the last week we had inched less than 90km a day closer to Parham.

The cloudbase started awkwardly low and early spreadout indicated considerable

moisture in the layers above 3,000ft. Some lines of energy felt like convergence but there were no signs of storms. The spreadout broke in cycles and the occasional climb to 3,000ft helped us across the biggest blocks of cloud, but progress was slow and we got disturbingly accustomed to operating below 1,000ft. Perhaps due to our low altitude, or maybe just the weeks of rain, the flies were particularly bad and after two hours airborne, our wings were black.

Past Soissons the cloud looked completely clamped in, and despite a climb to 3,500ft in slightly dryer air, we took to the engines and pushed further into the thickening overcast for an airfield that would give us a chance of the Channel in the morning.

Cloudbase slipped to 2,500ft, the headwind increased to 15kts and as a final aggravation, light rain spoilt a glide for Amiens twice. As we reached the circuit for the field, the cloudbase lifted slightly and we watched a Puchacz release from aerotow and spiral off downwind. Paul was low and, despite announcing his intentions on the tower frequency, had a near-miss with a King Air twin on short finals. A very heated debate shattered the usually indolent airwaves and I was told to follow French procedure when I asked for landing instructions in turn. An English voice instructed me to speak in French at Amiens but, despite my continued efforts, I could not persuade any further communication. I followed Paul's example landing on the grass, and waited for the inevitable fireworks. After a little intervention from the older, wiser instructors on the field, we were finally welcomed.

It was a busy field with glider, microlight, aerobatic and pleasure flying. We tanked up with fuel ready for the morning and treated ourselves to a motel room to prepare for our last day. We looked longingly at the local supermarket's shelves stocked with fine wines and smelly cheeses and tried to wedge the bare minimum into the cockpit. Try as we might, we realised it was not so much everything in its place, but everything in the same place – the disadvantages of compact living.

The day dawned like too many that summer, with low cloud and a biting wind. The streets looked soarable early and we tucked in under the low fat lines of cu confident that we could make Le Touquet to clear customs with the minimum of engine time. The wind was too far west to make passage to the north-east coast easy and the cloudbase was soon down below 2,000ft as we approached Abbeville and the Somme delta. The cloud was forming along the coastline and the deep blue sea beyond promised a calm crossing.

When we could see Le Touquet, we called for landing instructions and were slotted into the pattern. The apron was busy but we taxied to a parking space together. We had no need to refuel so, after filing our flight plan and clearing customs, we were keen to get back into the air. Forty-five minutes after

touching down, we were cleared to take off for the last time, and climbed into the light headwind out into the channel. Sixteen minutes later we were at 7,000ft, 25km over the channel with a comfortable glide to the Lydd peninsula. The glide was uneventful and London Information cleared us to enter UK airspace as a formation. Scanning the UK gliding frequencies, we soon picked up familiar voices, as our Southdown GC colleagues were trying to make the best of the low cloudbases to fly cross-country.

We coasted in passing 2,800ft but were below 2,000ft before we found the first scraps of convergence 10km inland. We tiptoed the last 90km to Parham, occasionally finding well-formed convergence, but we soon discovered that the tendrils clouds were rarely worth diverting far from track. Away from France's yellow cornfields, the agriculture became more verdant with every kilometre but soaring conditions did not keep pace with our rising expectations: the best conditions would have taken us north into London's airspace; instead we weaved through sea air and weak convergences.

After a last laudable attempt to escape an engine burn, we were below Ditchling Beacon, caught in shadow and sea air with 30km to run. After less than 1,000ft on the Rotax, we were back in lift and back to cloudbase at 3,000ft for a formation finish.

A month after incurring syndicate opprobrium, we could turn our way worn steeds over to our long-suffering collaborators for the rest of the summer. We had been away for 27 days and flown 115hrs and around 5,000km. The engines had run for 9hrs.

Motors in gliders are not the great panacea for poor soaring or ability and will always prove divisive with purists. I have been flying the DG-400 for six years: not only has the iron thermal opened many doors, and provided some great soaring I would not have considered before, but above all, it has transformed adventure – from dream to reality!

So, what next? Paul has the bug and wants to try for Africa. Any enthused adventurers please send description of toothbrush to us c/o S&G.



**LASHAM GLIDING SOCIETY**  
 LASHAM AIRFIELD  
 ALTON  
 HANTS GU34 5SS  
 Tel: 01256 384900  
 Fax: 01256 384901  
 E-mail: [office@lasham.org.uk](mailto:office@lasham.org.uk)  
 Web site: [www.lasham.org.uk](http://www.lasham.org.uk)

**Courses for 2004**

Solo to Bronze	Bronze to Silver
X-Country	Competition Training
Aerobatics	Task Weeks



**Some have a country cottage.  
Others have a place in the country.**

Many of our members drive past several other perfectly good clubs to get here, every weekend. It can't just be our 20 launch an hour retrieve winch system with a new 8.5 ltr Knox winch. Perhaps it's the fully professional winch drivers, office staff and catering. It could just be the friendly atmosphere or the traditional Saturday night dinner or the newly refurbished accommodation or the famous Mynd bar. Sure, this is one of the few places in Europe you can still bungee straight into wave but maybe it's more about the views and the buzzards and the Shropshire countryside.

Want a place in the country to get away to at the weekends?

**MIDLAND GLIDING CLUB**  
[www.longmynd.com](http://www.longmynd.com)

MGC, Longmynd, Church Stretton, Shropshire, SY6 6TA 01588 650206



Champagne celebrations on a successful return home

For updates to the BGA club directory, see  
[www.gliding.co.uk](http://www.gliding.co.uk)

**NORTH YORKSHIRE SAILPLANES**  
[www.nysailplanes.co.uk](http://www.nysailplanes.co.uk)



**FULL REPAIR SERVICES IN:**

**GLASS / CARBON / KEVLAR / WOOD / METAL**  
**C of A renewals, modifications, tailwheels,**  
**maintenance, instrument panels,**  
**winglets, etc., etc.**

TEL: 01845 577341 MOBILE: 07711 889 245 FAX: 01845 577646  
 Unit M, Alanbrooke Industrial Park, Topcliffe, Thirsk, North Yorkshire YO7 3SE

**The ideal present  
 for any occasion!**

*The Platypus Papers:  
 Fifty Years of Powerless Pilotage*



"All soaring pilots should have this book on their shelves" – **George Moffat**

"Like Schweppes, it fizzes the whole way through" – **Derek Piggott**

"Don't read it in public unless you are willing to make a spectacle of yourself laughing out loud" – **Dave Allison**

"The funniest book ever written" – **Platypus**

**HOW TO BUY IT:** see *Tailfeathers*, page 25

**JAXIDA Condensation-free  
 ALL WEATHER COVERS**



**Protects your aircraft**

- against sun, rain, and snow
- 2 ply fabric with UV-coating
- Self-polishing action in the wind
- Easy for one person to fit

[www.jaxida.com](http://www.jaxida.com)

**JAXIDA COVER**, Strandmoellevej 144 • DK-4300 Holbaek, Denmark  
 Tel. +45 5944 0725 • Fax +45 5944 0609 • E-mail [jaxida@jaxida.dk](mailto:jaxida@jaxida.dk)

Design reg. 2062846  
 Pat. No. 9300546

**Gliding Club PC-Manager**

Membership - Flying Accounts - Finances - Correspondence - VAT - Flight Log - and many more...

**The most comprehensive gliding club management software  
 in the market. Suitable for clubs of any size and budget.**

**The choice of the largest gliding club in Europe !**

and for the pilot...

**PC-Flight Log for Glider Pilots**

£ 16.95 + VAT

**PC-Flight Log Power**

£ 19.95 + VAT

**Ideal Microsystems Limited**

0161 486 1177 (Cheshire - UK)

Additional information and evaluation versions available at

[www.IDEALmicrosystems.com](http://www.IDEALmicrosystems.com)

**The Premier Motor Gliding School**

- \* Courses or by the hour for NPPL SLMG & TMG PPL.
- \* Bronze C Cross Country & Field Landing Checks.
- \* Convert your BGA Licence to an NPPL SLMG.
- \* RT Examination Centre.

**Competitive Prices**



**Oxfordshire Sport Flying**

[www.enstoneaerodrome.co.uk](http://www.enstoneaerodrome.co.uk)  
 telephone 01608 677208

**SeeYou Mobile and LX Navigation LX 1600**  
 present a fully featured and affordable Vario-Logger-PDA solution

- Moving Map with final glide
- 3D Airspace warning
- In-flight statistics and 3D Wind
- Support for Assigned Area Tasks
- Newest technology variometer
- Speed command
- Controlled by PDA, stand alone operation possible
- Optimum configuration: LX 1600-Colibri-PDA

<http://Mobile.SeeYou.ws/>

<http://www.LXNavigation.si/>



# How to find a gliding club in the UK

If you want to sample a new site the map overleaf and the list below can help. Services clubs, which may restrict civilian entry, are in green. BGA club details are updated at [www.gliding.co.uk](http://www.gliding.co.uk), where affiliated university clubs are also listed

**ANDREAS GC (10):** Andreas Airfield, Braust Farm, Lezayre, Isle of Man; send post c/o Cranstal Cottage, Port e Vullen, Maughold, Ramsey, ISLE OF MAN, IM7 1AN  
 secretary@manxgliding.flyer.co.uk  
 www.manxgliding.flyer.co.uk

**ANGLIA GC (11):** [stephenmynott@hotmail.com](mailto:stephenmynott@hotmail.com)  
[www.geocities.com/angliaglidingclub](http://www.geocities.com/angliaglidingclub)

**ANGUS GC (1):** Drumshade Farm, Roundyhill, Glamis, By Forfar. 01575 572994/[eve47\\_mands@yahoo.com](mailto:eve47_mands@yahoo.com)  
[www.angusglidingclub.ukf.net](http://www.angusglidingclub.ukf.net)

**AQUILA GC (12):** Hinton-in-the Hedges Airfield, Steane, Brackley NN13 5NS  
 01295 811056/[info@aquilagliding.com](mailto:info@aquilagliding.com)  
[www.aquilagliding.com](http://www.aquilagliding.com)

**BANNERDOWN RAFGSA GC (13):** Keevil Airfield Clubhouse/launchpoint (w/ends) 01380 870411/07931 556646  
[bannerdown@tesco.net/www.bannerdowngc.co.uk](http://bannerdown@tesco.net/www.bannerdowngc.co.uk)

**BATH WILTS & NORTH DORSET GC (14):** The Park, Kingston Deverill, Warminster BA12 7HF  
 01985 844095/[info@bwnd.co.uk](mailto:info@bwnd.co.uk)  
[www.bwnd.co.uk](http://www.bwnd.co.uk)

**RAFSA BICESTER (15):** [www.rafgsa.org](http://www.rafgsa.org)  
 01869 252493/[manager@rafgsa.org](mailto:manager@rafgsa.org)

**BIDFORD GLIDING CENTRE (16):** Bidford Airfield, Bidford on Avon B50 4PD  
 01789 772606/[office@bidfordgliding.co.uk](mailto:office@bidfordgliding.co.uk)  
[www.bidfordgliding.co.uk](http://www.bidfordgliding.co.uk)

**BLACK MOUNTAINS GC (85):** The Airfield, Talgarth, Powys LD3 0EJ  
 01874 711463/[blackmountainsglidingclub@hotmail.com](mailto:blackmountainsglidingclub@hotmail.com)  
[www.talgarthgc.co.uk](http://www.talgarthgc.co.uk)

**BOOKER GC (17):** Wycombe Air Park, Marlow SL7 3DR  
 01494 442501/[office@bookergc.nildram.co.uk](mailto:office@bookergc.nildram.co.uk)  
[www.bookergliding.co.uk](http://www.bookergliding.co.uk)

**BORDERS GC (18):** The Airfield, Milfield Wooler NE71 6HD  
 01668 216284/[help@bordersgliding.co.uk](mailto:help@bordersgliding.co.uk)  
[www.bordersgliding.co.uk](http://www.bordersgliding.co.uk)

**BOWLAND FOREST GC (19):** Lower Cock Hill Fm, Fiddlers Lane, Chipping, Preston PR3 2WN  
 01995 61267/[enquiries@btgc.co.uk](mailto:enquiries@btgc.co.uk)  
[www.btgc.co.uk](http://www.btgc.co.uk)

**BRISTOL & GLOUCESTERSHIRE GC (20):** Nymphsfield, Stonehouse GL10 3TX  
 01453 860342/[secretary@bggc.co.uk](mailto:secretary@bggc.co.uk)  
[www.bggc.co.uk](http://www.bggc.co.uk)

**BUCKMINSTER GC (21):** Saltby Airfield, Sproxtton Road, Skillington, Grantham NG33 5HL  
 01476 860385/[office@buckminstergc.co.uk](mailto:office@buckminstergc.co.uk)  
[www.buckminstergc.co.uk](http://www.buckminstergc.co.uk)

**BURN GC (22):** The Airfield, Park La, Burn, Selby YO8 8LW  
 01757 270296/[burnglidingclub@bigfoot.com](mailto:burnglidingclub@bigfoot.com)  
[www.burnglidingclub.co.uk](http://www.burnglidingclub.co.uk)

**CAIRNGORM GC (2):** Blackmill Airstrip, Feshiebridge, Kincaig, Inverness-shire  
 01540 651317/[gliding@feshiebridge.freeserve.co.uk](mailto:gliding@feshiebridge.freeserve.co.uk)  
[www.gliding.org](http://www.gliding.org)

**CAMBRIDGE GC (23):** Gransden Lodge Airfield, Lodge Farm, Longstowe Road, Little Gransden, Sandy, Beds SG19 3EB  
 01767 677077/[office@glide.co.uk](mailto:office@glide.co.uk)  
[wwwwww.glide.co.uk](http://wwwwww.glide.co.uk)

**CARLTON MOOR GC (24):** Carlton Moor, Nr Stokesley, North Yorkshire  
 01642 778234 (w/e)/[enquiries@carltonmoorglidingclub.org.uk](mailto:enquiries@carltonmoorglidingclub.org.uk)  
[www.carltonmoorglidingclub.org.uk](http://www.carltonmoorglidingclub.org.uk)

**CHANNEL GC (25):** Waldershare Park, Nr. Whitfield, Dover, Kent CT15 5NH  
 01304 824888/[NicBearcraft@aol.com](mailto:NicBearcraft@aol.com)

**CHILTERN SGC (26):** [www.chilternsgc.fsnet.co.uk](http://www.chilternsgc.fsnet.co.uk)  
 01296 623535 x7002 mailbox 5198  
[info@chilternsgc.fsnet.co.uk](mailto:info@chilternsgc.fsnet.co.uk)

**CLEVELANDS GC (27):** [www.dishforthairfield.freeserve.co.uk](http://www.dishforthairfield.freeserve.co.uk)  
 Clubhouse 01423 321642/Mobile 07779 454124

**CONNEL GC (3):** Oban Airport, North Connel, By Oban, Argyll PA37 1RT  
 01631 710428/[stewart@macfarlane.evesham.net](mailto:stewart@macfarlane.evesham.net)

**CORNISH GLIDING & FLYING CLUB (28):** Perranporth Airfield, Trevellas, Nr Perranporth TR6 9QB  
 01872 572124/[cornslide@aol.com](mailto:cornslide@aol.com)  
<http://members.aol.com/cornslide/page1.htm>

**COTSWOLD GC (29):** The Control Tower, Aston Down Airfield, Nr Minchinhampton, Stroud, Glos GL6 8HT  
 01285 760415/[pat@cotswoldgliding.co.uk](mailto:pat@cotswoldgliding.co.uk)  
[www.cotswoldgliding.co.uk](http://www.cotswoldgliding.co.uk)

**CRANWELL GC (30):** [www.cranwellgc.freeserve.co.uk](http://www.cranwellgc.freeserve.co.uk)  
[lan@fitzpatrick.co.uk](mailto:lan@fitzpatrick.co.uk)

**DARTMOOR GLIDING SOCIETY (31):** Burnford Common, Brentor, Tavistock, Devon  
 01822 810712/[mark.cooper5@ntlworld.com](mailto:mark.cooper5@ntlworld.com)  
<http://www.dartmoor-gliding.com/>

**DEESIDE GC (4):** Aboyne Airfield, Dinnet, Aboyne, Aberdeen AB34 5LB  
 01339 885339/[deeside@glidingclub.co.uk](mailto:deeside@glidingclub.co.uk)  
[www.richardcaw.freeserve.co.uk](http://www.richardcaw.freeserve.co.uk)

**DENBIGH GC (86):** Mold Road, Denbigh, Clwyd  
 01745 813774/[office@denbighglidingclub.co.uk](mailto:office@denbighglidingclub.co.uk)  
[www.denbighglidingclub.co.uk/](http://www.denbighglidingclub.co.uk/)

**DERBYSHIRE & LANCASHIRE GC (32):** Camphill, Great Hucklow, Tideswell, Buxton, SK17 8RQ  
 01298 871270/[dlgc@gliding.u-net.com](mailto:dlgc@gliding.u-net.com)  
[www.dlgc.org.uk](http://www.dlgc.org.uk)

**DEVON & SOMERSET GC (33):** North Hill Airfield, Broadhembury, Honiton EX14 3LP  
 01404 841386/[dsgc@fly.to](mailto:dsgc@fly.to)  
[www.dsgc.co.uk/](http://www.dsgc.co.uk/)

**DORSET GC (34):** Eyres Field, Puddletown Road, Hyde, Wareham BH20 7NC  
 01929 405599/[www.dorsetglidingclub.freeserve.co.uk](http://www.dorsetglidingclub.freeserve.co.uk)

**DUKERIES GC (35):** Gamston Airfield, Gamston, East Retford (Not a postal address)  
 01909 731436/[adele@swannack60.freeserve.co.uk](mailto:adele@swannack60.freeserve.co.uk)

**DUMFRIES & DISTRICT GC (5):** Falgunzeon, By Dalbeattie, Dumfries & Galloway  
 01387 760601/[kaz@paszki.freeserve.co.uk](mailto:kaz@paszki.freeserve.co.uk)  
[www.paszki.freeserve.co.uk/dgdc.htm](http://www.paszki.freeserve.co.uk/dgdc.htm)

**EAST SUSSEX GC (36):** Kitson Field, The Broyle, Ringmer, East Sussex BN8 5AP  
 01825 840347/[stevfost@aol.com](mailto:stevfost@aol.com)  
[www.sussexgliding.co.uk/](http://www.sussexgliding.co.uk/)

**ESSEX GC (37):** North Weald Airfield, Merlin Way, North Weald CM16 6AA (01992 522222); Ridgewell Airfield, Pannells Ash, Ashen, Ridgewell CO10 8JU (01440 785103)  
[egc@glidingclub.co.uk/www.essexgliding.org](mailto:egc@glidingclub.co.uk/www.essexgliding.org)

**ESSEX & SUFFOLK GC (38):** Wormingford Airfield, Fordham Road, Wormingford, Colchester, CO6 3AQ  
 01206 242596/[Glide@esgc.flyer.co.uk](mailto:Glide@esgc.flyer.co.uk)  
[www.esgc.co.uk](http://www.esgc.co.uk)

**FENLAND GC (39):** [www.glidingclub.freeserve.co.uk/delboy@glidingclub.freeserve.co.uk](http://www.glidingclub.freeserve.co.uk/delboy@glidingclub.freeserve.co.uk)

**FOUR COUNTIES (40):** RAF Barkston Heath (temporary site – send post to Syerston)  
[www.fourcountiesglidingclub.co.uk/](http://www.fourcountiesglidingclub.co.uk/)  
 07813542884 (w/e mobile) /[sue@fourcountiesglidingclub.co.uk](mailto:sue@fourcountiesglidingclub.co.uk)

**FULMAR (6):** Easterton Airfield, Birmie, Elgin, Morayshire  
 Post: David Brown, 10 Mannachie Rise, Forbes, Moray, IV36 2US  
 01309 676660/01088088/[student.gla.ac.uk](mailto:student.gla.ac.uk)

**HEREFORDSHIRE GC (41):** Shobdon Airfield, Shobdon HR6 9NR  
 01568 708908/[gliding@shobdon.com](mailto:gliding@shobdon.com)  
[www.shobdon.com](http://www.shobdon.com)

**HERON GC (42):** RNAS Yeovilton  
 CFI: [derek@laleham-house.fsnet.co.uk](mailto:derek@laleham-house.fsnet.co.uk)/01935 863055

**HIGHLAND GC (7):** Easterton Airfield, Birmie, Elgin, Morayshire. Post to: Secretary, HGC, Drum Farm, Keith AB55 5NP  
 01343 860272/[admin@highglide.co.uk](mailto:admin@highglide.co.uk)  
[www.highglide.co.uk](http://www.highglide.co.uk)

**IMPERIAL COLLEGE GC (43):** Lasham Airfield, Lasham, Alton GU34 5SS  
 01256 384900/[icgc-committee@ic.ac.uk](mailto:icgc-committee@ic.ac.uk)  
[www.su.ic.ac.uk/gliding](http://www.su.ic.ac.uk/gliding)

**KENT GC (44):** Squids Gate, Challock, Kent TN25 4DR  
 01233 740274/740307/[soaring@kent-gliding-club.co.uk](mailto:soaring@kent-gliding-club.co.uk)  
[www.kent-gliding-club.co.uk/](http://www.kent-gliding-club.co.uk/)

# UK Clubs Directory

© S N Longland & British Gliding Association 2004

2004



- WALES
- 85 Black Mountains (Talgarth) ▲
  - 86 Denbigh (Denbigh) ▲
  - 87 North Wales (Llanstifilio) ▲
  - 88 South Wales (Usk) ▲
  - 89 Vale of Neath (Rhigos) ▲

- 66 Shalbourne (Rivar Hill) ▲
- 66 Shenington (Shenington)
- 67 Shropshire Soaring Group (Sleep)
- 68 Southdown (Parham) ▲
- 69 South London Gliding Centre (Kenley)
- 70 Staffordshire (Seighford)
- 71 Stratford on Avon (Snitterfield)
- 72 Surrey & Hants (Lasham)
- 73 The Motor Glider Club (Hinton-in-the-Hedges)

- ENGLAND - continued
- 74 The Soaring Centre (Husbands Bosworth)
  - 75 Trent Valley (Kirtton in Lindsey)
  - 76 Upward Bound Trust (Thame)
  - 77 Vale of White Horse (Shrivenham)
  - 78 Vecils (Benbridge) ▲
  - 79 Welland (Lyveden)
  - 80 Wolds (Pocklington)
  - 81 Wrekin (Cosford)
  - 82 Wyvern (Upavon)
  - 83 York Gliding Centre (Rufforth)
  - 84 Yorkshire (Sutton Bank) ▲

Over 1000m (3,280ft)

500 - 1000m

200 - 500m

100 - 200m

0 - 100m

### SCOTLAND

- 1 Angus (Drumshade) ▼
- 2 Cairngorm (Feshiebridge) ▼
- 3 Connel (Oban) ▼
- 4 Deeside (Aboyne) ▼
- 5 Dumfries & District (Falgunzeon) ▼
- 6 Fulmar (Easterton) ▼
- 7 Highland (Easterton) ▼
- 8 Scottish Gliding Centre (Portmouk) ▼
- 9 Strathclyde (Strathaven) ▼

### NORTHERN IRELAND

- 90 Ulster (Bellarena) ▼



### ENGLAND

- 10 Andreas (Isle of Man) - [Crown Protectorate]
- 11 Anglia (Wattisham)
- 12 Aquila (Hinton-in-the-Hedges)
- 13 Bannerdown (Keewill) ▼
- 14 Bath, Wills & North Dorset (Kingston Deverill)
- 15 Bicester (RAF Bicester)
- 16 Bidford Gliding Centre Ltd (Bidford)
- 17 Booker (Wycombe Air Park)
- 18 Borders (Milfield) ▼
- 19 Bowland Forest (Chipping) ▼
- 20 Bristol & Gloucestershire (Nympsfield) ▼
- 21 Buckminster (Salby)
- 22 Burn (Selby)
- 23 Cambridge (Gransden Lodge)
- 24 Carlton Moor (Carlton Moor) ▼
- 25 Channel (Waldeshare Park)
- 26 Chilliers (RAF Halton) ▼
- 27 Clevelands (RAF Dishforth)
- 28 Cornish Gliding & Flying Club (Perranporth) ▼
- 29 Cotswold (Astton Down)
- 30 Cranwell (RAF Cranwell)
- 31 Dartmoor Gliding Society (Brentor)
- 32 Derby & Lincs (Camp Hill) ▼
- 33 Devon & Somerset (North Hill) ▼
- 34 Dorset (Hyde, Wareham)
- 35 Dukeries (Ganston)
- 36 East Sussex (Ringmer)
- 37 Essex (North Weald & Ridgewell)
- 38 Essex & Suffolk (Wormingford)
- 39 Fenland (RAF Marham)
- 40 Four Counties (RAF Barkston Heath)
- 41 Herefordshire (Shobdon) ▼
- 42 Heron (RNAS Yeovilton)
- 43 Imperial College (Lasham)
- 44 Kent (Challock)
- 45 Kestrel (Odiham [Army])
- 46 Lakes (Walney Island) ▼
- 47 Lasham Gliding Society (Lasham, Alton)
- 48 Lincolnshire (Strubby, Alford)
- 49 London (Dunstable) ▼
- 50 Mendip (Halesland) ▼
- 51 Midland (Long Mynd) ▼
- 52 Needwood Forest (Cross Hayes)
- 53 Nene Valley (Upwood)
- 54 Newark & Notts (Winthorpe)
- 55 Norfolk (Tibham)
- 56 North Devon (Eaglescott)
- 57 Northumbria (Currock Hill)
- 58 Oxford (RAF Weston on the Green)
- 59 Oxfordshire Sport Flying (Enstone)
- 60 Peterborough & Spalding (Crowland)
- 61 Portsmouth Naval (Lee on Solent)
- 62 Rattlesden (Rattlesden)
- 63 Sackville (Riseley)
- 64 Seahawk (RNAS Culdrose & Predannack)
- 65 Spalgrave (River Hill) ▼
- 66 Sherington (Sherington) ▼

# BGA MEMBER CLUBS

## ➤ KESTREL GC (45):

01372 458579/[chriswick85@hotmail.com](mailto:chriswick85@hotmail.com)

## LAKES GC (46):

Walney Airfield, Barrow In Furness, LA14 3YJ  
07860 135447/[LGCB@Braithwaite.freewire.co.uk](mailto:LGCB@Braithwaite.freewire.co.uk)  
[www.lakesgc.co.uk](http://www.lakesgc.co.uk)

## LASHAM GLIDING SOCIETY (47):

Lasham Airfield, Alton GU34 5SS  
01256 384900/[office@lasham.org.uk](mailto:office@lasham.org.uk)  
[www.lasham.org.uk](http://www.lasham.org.uk)

## LINCOLNSHIRE GC (48):

Strubby Airfield, Alford LN13 1AA  
01507 450698/[www.lincolnshireglidingclub.co.uk/](http://www.lincolnshireglidingclub.co.uk/)

## LONDON GC (49):

Tring Road, Dunstable LU6 2JP  
01582 663419/[info@gliding.powernet.co.uk](mailto:info@gliding.powernet.co.uk)  
[www.londonglidingclub.co.uk](http://www.londonglidingclub.co.uk)

## MENDIP GC (50):

Halesland Airfield, New Rd, Priddy, Wells, BA5 3BX  
01749 870312 (Thurs+we only)/[haxell@clara.net](mailto:haxell@clara.net)  
[www.mendipglidingclub.co.uk](http://www.mendipglidingclub.co.uk)

## MIDLAND GC (51):

The Long Mynd, Church Stretton, Shropshire SY6 6TA  
01588 650206/[office@longmynd.com](mailto:office@longmynd.com)  
[www.longmynd.com](http://www.longmynd.com)

## NEEDWOOD FOREST GC (52):

Cross Hayes Field, Maker Lane, Hoar Cross, Burton upon Trent DE13 8QR  
01283 575578/[nfgc@gogliding.co.uk](mailto:nfgc@gogliding.co.uk)  
[www.gogliding.co.uk](http://www.gogliding.co.uk)

## NENE VALLEY GC (53):

Marshals Paddock, Ramsey Road, Upwood PE26 2PH  
07761 478417/[jbhatfield@ntlworld.com](mailto:jbhatfield@ntlworld.com)  
[www.nvgc.org.uk/](http://www.nvgc.org.uk/)

## NEWARK & NOTTS GC (54):

The Club House, Drove Lane, Winthorpe, Newark NG24 2NY  
01636 707151/[newarkgc@hotmail.com](mailto:newarkgc@hotmail.com)  
[www.newarknottsglidingclub.freemove.co.uk/](http://www.newarknottsglidingclub.freemove.co.uk/)

## NORFOLK GC (55):

Tibham A/F, Long Stratton NR16 1NT  
01379 677207/[norfolkgc@hotmail.com](mailto:norfolkgc@hotmail.com)  
[www.ngcglide.freemove.co.uk](http://www.ngcglide.freemove.co.uk)

## NORTH DEVON GC (56):

Eaglescott A/F, Burrington, Umberleigh, North Devon EX37 9LH  
01769 520404/[www.eaglescott-airfield.com](http://www.eaglescott-airfield.com)

## NORTH WALES GC (87):

Llantilio Airfield, Gefnfordd Lane, Nr Llandegla  
(Not a postal address)  
07956 498078/[brianp@nwgc.org.uk](mailto:brianp@nwgc.org.uk)  
[www.nwgc.org.uk](http://www.nwgc.org.uk)

## NORTHUMBRIA GC (57):

Currock Hill, Chopwell, Newcastle Upon Tyne NE17 7AX  
01207 561286/[Info@northumbria.flyer.co.uk](mailto:Info@northumbria.flyer.co.uk)  
[www.northumbria-gliding-club.co.uk](http://www.northumbria-gliding-club.co.uk)

## OXFORD GC (58):

RAF Weston On The Green, Nr Bicester OX6 8TQ  
01869 343403/[secretary@oxford-gliding-club.co.uk](mailto:secretary@oxford-gliding-club.co.uk)  
[www.oxford-gliding-club.co.uk](http://www.oxford-gliding-club.co.uk)

## OXFORDSHIRE SPORTFLYING LTD (59):

Enstone Aerodrome, Church Enstone OX7 4NP  
01608 677208/[osi@enstoneaerodrome.co.uk](mailto:osi@enstoneaerodrome.co.uk)  
[www.enstoneaerodrome.co.uk](http://www.enstoneaerodrome.co.uk)

## PETERBOROUGH & SPALDING GC (60):

Postland Airfield, Crowland, Lincs  
01733 210463/[Chairman@psgc.co.uk](mailto:Chairman@psgc.co.uk)  
[www.psgc.co.uk](http://www.psgc.co.uk)

## PORTSMOUTH NAVAL GC (61):

[www.pngc.co.uk](http://www.pngc.co.uk)

## RATTLEDEN GC (62):

Rattlesden Airfield, Hightown Green, Rattlesden,  
Bury St. Edmunds IP0 0SX  
01449 737789/[andy.page.ap@bayer.co.uk](mailto:andy.page.ap@bayer.co.uk)  
[www.ratair.co.uk](http://www.ratair.co.uk)

## SACKVILLE GC (63):

Sackville Lodge Fm, Riseley MK44 1BS  
01234 708877

## SCOTTISH GLIDING CENTRE (8):

Portmoak Airfield, Scotlandwell, By Kinross KY13 7JJ  
01592 840543 [office@scottishglidingcentre.co.uk](mailto:office@scottishglidingcentre.co.uk)  
[www.scottishglidingcentre.co.uk/](http://www.scottishglidingcentre.co.uk/)

## SEAHAWK GC (64):

RNAS Culdrose  
Secretary/PRO: [michael.vean@btinternet.com](mailto:michael.vean@btinternet.com)

## SHALBOURNE SOARING SOCIETY (65):

Rivar Hill Airfield, Henley, Nr Marlborough SN8 3RJ  
01962 779333  
[www.shalbournegliding.co.uk](http://www.shalbournegliding.co.uk)

## SHENINGTON GC (66):

Shenington Airfield, Shenington OX15 6NY  
01295 688121 or 680008/[Gliding.club@virgin.net](mailto:Gliding.club@virgin.net)  
[www.shenington-gliding.co.uk/](http://www.shenington-gliding.co.uk/)

## SHROPSHIRE SOARING GROUP (67):

Sleap Airfield, Nr Wem SY4 3HE  
01939 232045/[c.ratcliffe@tesco.net](mailto:c.ratcliffe@tesco.net)/[keithfield@welshwave.co.uk](mailto:keithfield@welshwave.co.uk)  
[www.welshwave.co.uk](http://www.welshwave.co.uk)

## SOUTHDOWN GC (68):

Parham A/F, Pulborough Rd, Cootham, Pulborough RH20 4HP  
01903 746706/[Southdown@sephoton30.freemove.co.uk](mailto:Southdown@sephoton30.freemove.co.uk)  
[www.southdown-gc.demon.co.uk](http://www.southdown-gc.demon.co.uk)

## SOUTH LONDON GLIDING CENTRE (69):

Kenley Airfield, Caterham On The Hill CR8 5YG  
0208 763 0091/[www.southlondongliding.co.uk](http://www.southlondongliding.co.uk)

## SOUTH WALES GC (88):

The Airfield, Gwernesney, Usk  
01291 690536/[Dave.jeffries@btinternet.com](mailto:Dave.jeffries@btinternet.com)  
[www.users.globalnet.co.uk/~tonyho](http://www.users.globalnet.co.uk/~tonyho)

## STAFFORDSHIRE GC (70):

Seighford A/F, Seighford, Stafford  
01785 282575/[office@staffordshiregliding.co.uk](mailto:office@staffordshiregliding.co.uk)  
[www.staffordshiregliding.co.uk](http://www.staffordshiregliding.co.uk)

## STRATHCLYDE GC (9):

Strathaven Airfield, Strathaven  
01357 520235/[mail@strathclydeglidingclub.co.uk](mailto:mail@strathclydeglidingclub.co.uk)  
[www.strathclydeglidingclub.co.uk](http://www.strathclydeglidingclub.co.uk)

## STRATFORD ON AVON GC (71):

Snitterfield airfield,  
Bearly Road, Snitterfield, Stratford on Avon CV37 0EG  
01789 731095/[geoff@gbutler.demon.co.uk](mailto:geoff@gbutler.demon.co.uk)  
[www.gbutler.demon.co.uk/soagc/index.htm](http://www.gbutler.demon.co.uk/soagc/index.htm)

## SURREY & HANTS GC (72):

See **Lasham** or [www.surreyandhants.org.uk](http://www.surreyandhants.org.uk)

## THE MOTOR GLIDER CLUB (73):

Hinton-in-the-Hedges Airfield, Steane, Brackley NN13 6LX  
01295 812775/[Tompit@aol.com](mailto:Tompit@aol.com)

## THE SOARING CENTRE (74):

Husbands Bosworth Airfield, Lutterworth LE17 6JJ  
01858 880521/880429/[office@thesoaringcentre.co.uk](mailto:office@thesoaringcentre.co.uk)  
[www.thesoaringcentre.co.uk](http://www.thesoaringcentre.co.uk)

## TRENT VALLEY GC (75):

The Airfield, Kirtan In Lindsey, Gainsborough, Lincs  
01652 648777/[pwdewick@hotmail.com](mailto:pwdewick@hotmail.com)  
[www.tvgc.freemove.co.uk](http://www.tvgc.freemove.co.uk)

## ULSTER GC (90):

Bellarena, Seacoast Road, Nr Limavady, County Londonderry  
028 7775 0301/[tom.snoddy@nireland.com](mailto:tom.snoddy@nireland.com)  
[www.gliding.utvinternet.com](http://www.gliding.utvinternet.com)

## UPWARD BOUND TRUST GC (76):

Aylesbury/Thame  
Airfield, Haddenham, Bucks (Not a postal address)  
01295 738507/[david@aromatic.isnet.co.uk](mailto:david@aromatic.isnet.co.uk)

## VALE OF NEATH GC (89):

Rhigos Airfield, Mount Road,  
Cefn Rhigos, Nr Glynneath, Mid-Glamorgan  
<http://hometown.aol.co.uk/rhigosgliding/myhomepage/flying.html>

## VALE OF WHITE HORSE GC (77):

Sandhill Farm Airfield, Shrivvenham, SWINDON, Wilts; Post to:  
Mr C Beveridge, 49, Adkin Way, Wantage, OX12 9HN  
01793 783685 or 01793 725265/[vowhgc@email.com](mailto:vowhgc@email.com)  
[www.swindongliding.co.uk](http://www.swindongliding.co.uk)

## VECTIS GC (78):

Hangar No 1, Bembridge Airport, Bembridge, Isle of Wight;  
post to: Alasdair MacLean, 140 St Edmunds Walk, Wootton  
Bridge, Ryde, Isle of Wight PO33 4JJ  
01983 883884/[alasdair@amaclean.flyer.co.uk](mailto:alasdair@amaclean.flyer.co.uk)  
[www.vectisglidingclub.co.uk/](http://www.vectisglidingclub.co.uk/)

## WELLAND GC (79):

Lyveden Airfield, Harley Way, Lyveden Road, Brigstock,  
Kettering, Northants  
01832 205237/[suzanne.harris@lineone.net](mailto:suzanne.harris@lineone.net)  
[www.welland.skynet.co.uk](http://www.welland.skynet.co.uk)

## WOLDS GC (80):

The Airfield, Pocklington, York YO42 1NP  
01759 303579/[office@wolds-gliding.org](mailto:office@wolds-gliding.org)  
[www.wolds-gliding.org](http://www.wolds-gliding.org)

## WREKIN GC (81):

RAF Cosford  
Clubhouse: 01902 377255/mobile: 07719 732746 (Sat/Sun)  
[www.geocities.com/wreking/wrekin.html](http://www.geocities.com/wreking/wrekin.html)

## WYVERN GC (82):

[secretary@wyverngliding.org.uk](mailto:secretary@wyverngliding.org.uk)  
Secretary: 01264 782812/Hangar: 01980 615283  
[www.wyverngliding.org.uk](http://www.wyverngliding.org.uk)

## YORK GLIDING CENTRE (83):

Rufforth Aerodrome, Rufforth, York YO2 3QA  
01904 738694/[yorkglidingcentre@btinternet.com](mailto:yorkglidingcentre@btinternet.com)  
[www-users.york.ac.uk/~mdc1/ygc.html](http://www-users.york.ac.uk/~mdc1/ygc.html)

## YORKSHIRE GC (84):

Sutton Bank, Thirsk YO7 2EY  
01845 597237/[enquiry@ygc.co.uk](mailto:enquiry@ygc.co.uk)/[www.ygc.co.uk](http://www.ygc.co.uk)

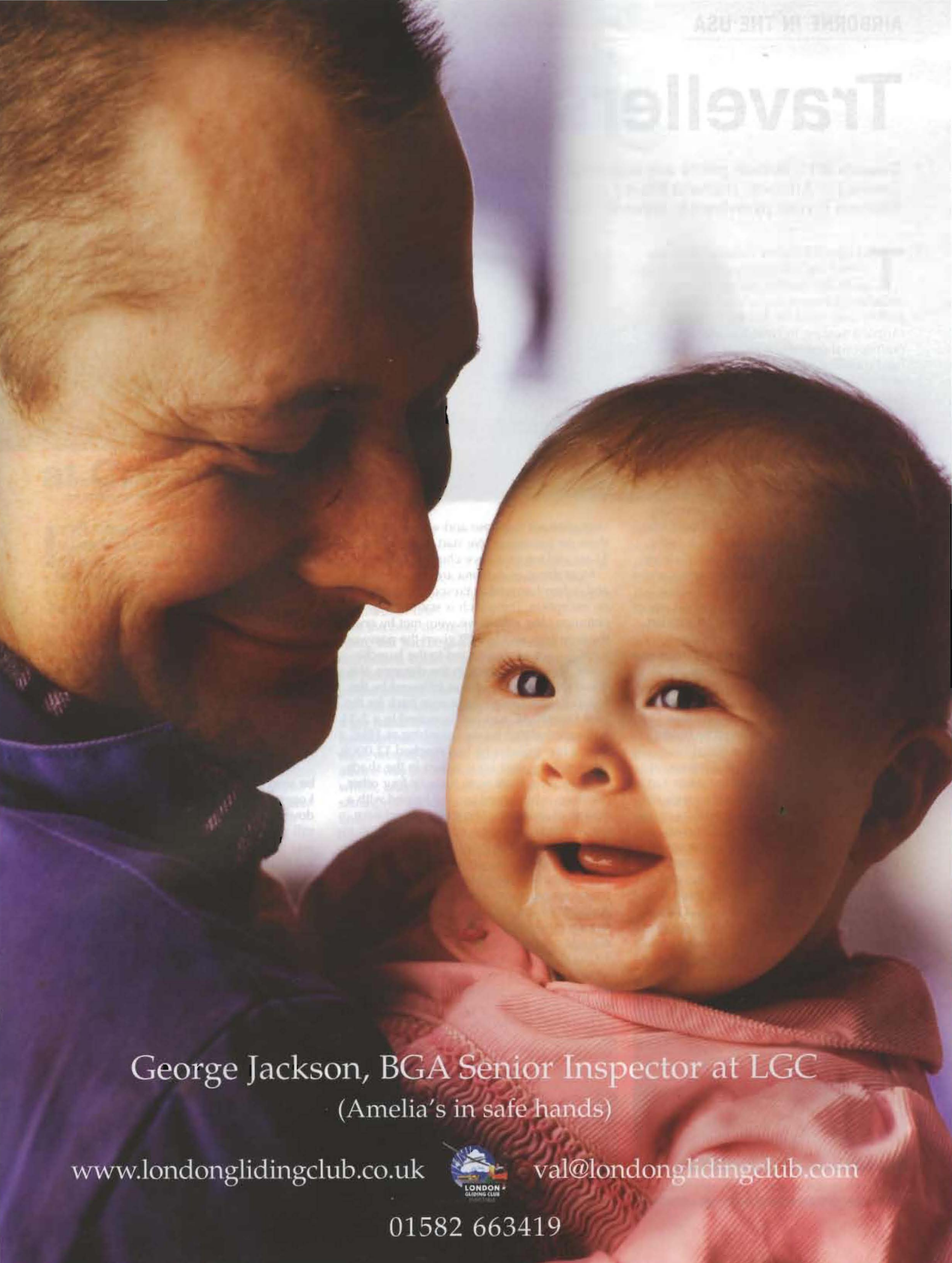

George Jackson, BGA Senior Inspector at LGC  
(Amelia's in safe hands)

[www.londonglidingclub.co.uk](http://www.londonglidingclub.co.uk)



[val@londonglidingclub.com](mailto:val@londonglidingclub.com)

01582 663419

# Travellers' tales

Despite 9/11, British pilots are still soaring in the States: Chris Ellis (*below*) in Arizona; Richard Starey (*opposite*), in California, and Graham Turner (*overleaf*) in Nevada. The travellers tell their tales...

**T**O QUOTE Monty Python: "Now for something completely different". If you go to the Soaring Society of America's website – [www.ssa.org](http://www.ssa.org) – you will find five gliding sites listed for Arizona. Two of them (Arizona Soaring Inc and Turf Soaring) are professional operations by aerotow from hard runways. Sky King Soaring, run by Russ and Cynthia Husted, offers "powered sailplane tours" in a Super Dimona from Payson, Mesa and Sedona airports. I flew with Russ a couple of years ago on a spectacular photographic flight to the snow-capped "four peaks" mountain range.

This leaves the two sites that are actual members' clubs. I have in the past been made very welcome at Tucson Gliderport, which is the home of Tucson Soaring Club Inc, a club much on the same scale as my home one at the Long Mynd. They fly from an old military airfield on Wednesdays and weekends and are aerotow only.

If you ask about the Prescott club at any of the above establishments a sort of puzzled expression appears on the face of the respondent and they mutter something about it being a winching site somewhere up north, then shuffle off wondering why anyone would ask such a damn fool question.

The town of Prescott is very pleasant indeed. The capital of the Territory before Arizona became a State, it is about 100 miles north of the capital, Phoenix, at 5,000ft asl in one of the prettiest parts. On a trip last spring I was determined to seek out this mysterious gliding club as well as enjoy a day out in Prescott's cool, leafy streets. Phoenix was sweltering in temperatures of 109F°, 10° higher than the May average.

My quest started with a call to the phone number from the website, which listed the fleet of an SGS 1-26, an SGS 2-33, a Blanik and a Scheibe Zugvogel 3 – but this was out of date. The fleet has increased since then. It also said: "members only, no rides". I had a



very pleasant response and was invited to be there on Saturday: "We start flying around 11am and say you have checked with AC"

Most things in Arizona are "awesome" and, when I arrived at Prescott, this site was no exception. The winch is stationed by the entrance gate, where we were met by one of the members and having given the password – "AC" – we were directed to the launch-point. This was a speck in the distance. We drove down the winch run followed by the tow-out truck bringing the wire back for the next launch. AC had just launched in a 2-33 and reported that he was climbing at 10kt; after a few minutes he had reached 12,000ft. We spent the next hour or two in the shade of an awning chatting to three or four other members who turned up and helped with a couple of launches. The single-strand wire, we were told, is over a mile long, 6,070ft to be more exact. This must be a record. I have never heard of a winch run that long and it must be quite a weight to drag into the air. Launches reach an average height of 2,000ft. As the field is 5,000ft asl, with a 2,000ft launch followed by 10kt thermals it does not take all that long to reach cloudbase at 12,000ft. The club has a membership of around 40 and is very much a hands-on DIY affair with a wonderfully laid-back and relaxed Arizona atmosphere.

There are no such refinements as a hangar or clubhouse – a couple of caravans provide storage facilities. The gliders are permanently rigged and outdoors, firmly anchored to the ground with a wire fence to keep the cattle off. Protection from the sun is provided by shades over the canopies. The Zugvogel has a sort of T-hangar without walls.

An interesting innovation is their method of returning the cable to the launchpoint. They found that by dragging the wire back behind the truck it would last for an average



Above: the winch is 6,070ft away down this track  
Left: the launchpoint – Prescott has no clubhouse

of 600 launches before wearing out. They have fitted an outrigger to the truck and put tyres every 100 yards down the side of the track. By dropping the wire along the tyres they have doubled its life.

My turn to fly came at about 1pm. Cloud cover had increased substantially and rain was expected within the next couple of hours. I climbed aboard the 2-33 with AC, who was described as Flight Chairman (CFI), and was hauled skywards, releasing at 2,100ft agl. By this time the thermals had lost some of their power but we settled into a steady 4-5kt climb to cloudbase then set off for a tour of the area.

After about 45 minutes rain showers could be seen and having decided to go down I opened the brakes and stuck the nose down. Even rattling along at 60kt we were still going up at 1kt. The only way down was to find some sink and circle in that with full brake and sideslip. Not one of my best landings and then we hurriedly got everything tied down behind the cattle fence in the increasing wind before the rain.

A great club – and "awesome" in true Arizona style.

Chris Ellis



Bad weather forced a decision to land after 45 minutes



Chris launching in the 2-33 at Prescott Soaring Society (<http://members.tripod.com/~thrift/soaring/psa2.html>)

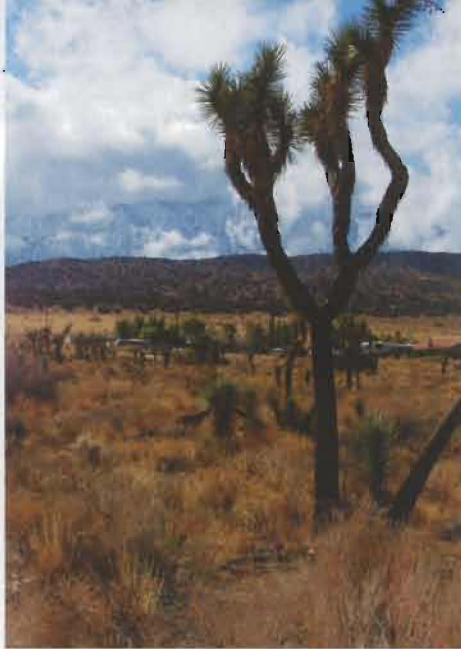

## No smoking at Crystallaire

**I**T WAS raining ash across much of the southern part of the State. By morning, the situation was no different. Parked cars were covered in a delicate film of cinders and the sky was white in pretence of snow. Not altogether happy about the prospect of staying on company business for two weeks in what resembled a Pompeii film set, I had decided to venture north for the weekend, away from the fires and my mushroom-coloured hotel room, to a range of mountains a little above Los Angeles, where the jagged peaks plunge down to the vast expanse of the Mojave Desert. Situated 40 miles on a north-easterly line from Hollywood is Crystallaire, which I was at that moment driving to, with the aid of Hertz satellite navigation and the promise of some quite spectacular soaring.

Interstate 15 disappeared, maybe only for a couple of seconds, but completely. I waited for the crunch as I stood on the brakes, only to be reunited with my lane, car intact and still moving forward. The wind, kicked up by the local fires in San Bernardino, was blowing sizeable volumes of the desert across the motorway. A flashing sign over the road signalled the closure of all



Top: the Joshua tree; above, advertising US-style



routes north and I took the exit into a small town. Disorientated, and taunted by my navigation assistant to rejoin I15, I slowed at a junction and wound down the window.

"Hello! Can you tell me how I can get to the north of LA?"

In the brief moment the window was open, ash had begun to accumulate on the dashboard, collecting in a neat pile around the No Smoking sticker. Both men were police officers. The one who answered me was not wearing, as the other man was, a gas mask. Instead, an American flag handkerchief was wrapped, highwayman-style, around his nose and mouth. His advice was a 100-mile circumnavigation, which, after I had dialled the route into the satnav, my unconcerned-sounding route finder told me would take three hours. I had booked a two-hour slot for a dual flight and called the airfield. Fortunately they had some space later on in the afternoon, and I turned in a little after lunch to a road marked by a trailer, with "Sailplane Rides" inscribed in big blue letters along its side.

Having flown in to LA the day before, struggled to keep my eyes closed for more than a couple of hours that night, and just



Top and above: the view from Richard's cockpit

completed a tortuous journey of earth, wind and fire, I stretched out on the clubhouse sofa, my head reeling. The 10,000ft peaks of the San Gabriel Mountains, no more than five miles away, promised ridge paradise. Dale was to be my P1. The door slammed open in the wind as he came in. He pulled a scarf away from his face and greeted me warmly.

"So, you've come to fly with us today!"

A bit of chat and a quick test on my understanding of wind gradients and we were walking over to the Grob 103. Suffice it to say, and with my previous but limited experience of flying in the US, I was not required to do anything more strenuous than climb into the glider. The cockpit felt somewhat roomy. I always feel a little naked not wearing a parachute, as if the few inches of material behind me make me feel suitably confident to take to the air. It is the same when diving, feeling properly dressed in a wetsuit, bottle and tubes, but quite intimidated snorkelling with just a mask and fins, even in shallow water.

"These forest fires," Dale muttered. "Terrorists!"

His statement left me feeling curiously uneasy. I might have dismissed any such remark as sensationalist, perhaps on a par with criticism that might be levelled at some over-zealous news reporting. But recent events have brought the immediacy of conflict right on to all our doorsteps. Maybe Dale was right.

We took up slack and were away. The desert ends on the horizon, only to continue to the next horizon, and the next, for 25,000 square miles. And not much of it is landable. Dry lakebeds, as found at the neighbouring Edwards Air Force Base, continue to be used for test flights and shuttle landings and have extremely flat clay surfaces, with "drawn on" ➤

runways for military and NASA pilots. But over much of the area the covering of rough grasses and cacti is decidedly aircraft-unfriendly. Crystallaire itself is surrounded by large cacti and Joshua trees, named by early Mormon pioneers after the Old Testament prophet Joshua, waving them on, with upraised arms, towards the Promised Land. We messed about in ridge lift, and later thermal, landing after about an hour of playground bliss.

The next day, San Diego did not go to work. The fires were so severe that people were advised to stay indoors with their families. I had taken over five hours to drive back to my hotel the previous day, finally taking a 70-mile cross-country route over the mountains. This amounted to an overwhelmingly large number of hairpin bends, taken late into the night, against a backdrop of hillside infernos.

The following Saturday I set off again, arriving at Crystallaire in a little under 90 minutes. The weather had become wintry – well, it was mid November. It was raining in LA, but the mountains were blocking the Pacific marine air from crossing on to the cu-popping desert side. Sharp temperature differences reputedly produce some very strong lift here. On a typical summer's day, it is soarable by 10am and, by mid-day, you can be setting off on a 500km dash from 14,000ft. For the rest of the year, Crystallaire enjoys largely uninterrupted ridge and wave.

I hired an Astir, beautifully maintained and equipped with a healthy display of instrumentation, including a transponder. It was mine for the afternoon. I had some pretensions to go somewhere, and was armed with a map, but decided when airborne to stay local. One hour into the flight, I picked up some wave and spent the next 90 minutes playing amongst the snow-dusted mountains, in heady ozone and stunning scenery.

I finally had to leave the fairy-tale mountain backdrop and my smoke-free gliding oasis. On returning, ash had now all but stopped falling in the hotel car park and my satnav was sounding bored. As I closed the lift door to my room, to begin another week of sales training, it was just possible to hear me utter that infamous phrase of the new Governor of California: "I'll be back!"

**Richard Starey**



The hosts at Crystallaire ([www.greatwesternsoaring.com](http://www.greatwesternsoaring.com))

# Hooked on Minden

**T**HANKS to Platypus' joyful description – "probably the best gliding site in the world" – Nevada's Minden must be known, at least by repute, to almost every British glider pilot.

I have been fortunate to be able to make one or more expeditions to Minden almost every year since 1997. Initially I went for the wave, but more recently it has been thermal conditions that have drawn me there.

Since it is so easy, and relatively cheap considering how far away it is, to get to Minden, I thought it might be interesting to jot down some of my recollections of flights there, perhaps to encourage other British glider pilots to head out that way.

Minden, or more properly Minden-Tahoe Airport, is situated in the Carson Valley, close to the California-Nevada border, just to the east of Lake Tahoe and the Sierra Nevada mountain range. Ground level in the valley is almost 5,000ft above sea level, with the Sierras rising a further 8,000ft.

When the jet stream sets up over this area it can produce perfect conditions for really strong wave off the Sierras, and at least one of the locals reckons to have been over 40,000ft in a glider more often than anyone else in the world!

If you head south from Minden you come to Mono Lake and then the Owens Valley running between the Sierras and the White Mountains. Further south yet, and a little to the east, there is Death Valley. East from Minden takes you towards the centre of the Great Basin, the aftermath of a vast inland sea that once covered most of Nevada.

Thermals can be fabulous, averaging 10kt or more to cloudbases around 18,000ft, but people who haven't been there yet tend to overlook the other side of this, the huge areas of 10kt sink, and the fact that places to land out without damaging the glider are rather far apart.

In April 1997 four of us, John Barrie-Smith and Geoff Chaplin from Lasham, and Jon Huband and myself from Sandhill Farm, arrived in Minden for the first time. After an initial briefing we were sent off to the FAA in Reno to get our US Glider Pilot Licences (this would not be nearly so easy now after September the 11th) and got back to the airfield around lunchtime.

As we prepared for site checks we naively asked: "where's the wave" to be told: "look up there". What we saw was a sky full of stretched-out cumulus clouds.

Metaphorically, we drew straws for the order of check flights and John went first. As well as the usual checks we were towed around in rotor to see how well we could cope with that amount of turbulence on tow and did wave familiarisation with one of the local instructors. John completed his checks then launched solo for an immediate Diamond height! My own checks came next,

but by the time I headed off on my own the wave window was closing – in the US all flights over FL180 are subject to ATC clearance – so I shot up to 18,000ft and then had to stop, quite frustrating.

The wave didn't return for a couple of days, and then not so strongly, but I did manage a flight to 22,000ft for my Gold height that year. On another trip I completed the Diamond with a flight to 27,000ft, and got my first "Lennie" for going above 25,000ft in wave. Since then I've also made a couple of flights above 30,000ft, which achieved my personal goal of being high enough to imagine the whole world, Everest and all, spinning underneath me without touching me. On one of those flights I even watched a local instructor climbing up in the wave as he was flying a succession of loops!

My real interest in wave now is for cross-country flying. In the right conditions it is possible to fly along the edge of the Sierras in wave for some considerable distance, which makes very fast cross-country speeds possible, limited only by the glider's VNE. Of course the record-breaking flights along the much longer Andes show that in the right place you can do much, much better.

So far I've had some fabulous *ad hoc* flights in wave at just below FL180, and declared one 300km out-and-return but ended up falling out of the wave north of Reno and then spending hours digging myself back up into the wave to get high enough to get back over Reno International Airport's airspace. A couple of days earlier John wasn't so lucky and Reno tower kindly gave him his own runway to land there, and routed 737s around him in the circuit.

After a few years of spring-time trips to Minden I felt I wanted to explore summer, thermal conditions there too. Mind you, even in March the conditions can be good enough for 300km tasks, but in mid-summer there is the potential for really long flights.

My work took me to the San Francisco Bay area a number of times one year and let me snatch summer weekends at Minden, and I began to learn the thermal ropes for the site and the area. One of the difficulties in the summer is to escape from the Carson Valley, since early in the day the inversion layer over the valley tends to be lower than the mountains surrounding it.

Then in the summer of 2000 I managed to arrange for a nine-day trip to Minden, with the aim of getting my third Diamond. For the first few days I attempted a number of 500km yo-yo tasks but ended up getting shot down each time by the wave that usually sets up towards the end of each day and greatly influences the thermals.

Getting tired of landing out I decided to try a different route and declared a 500km out-and-return task, making use of the logger for a remote start and finish, and a single



Left: edge of the Carson Valley and foothills of the Pine Nuts; above: gliders at Minden-Tahoe (www.soarminden.com)

turn point set up using the co-ordinates of a mountain peak in the Whites range, close to Tinemaha Dam.

The day looked promising but that turned out to be slightly deceptive. Getting launched was the first issue: my Discus was full of water and at about 5,000ft elevation and over 30°C I needed almost the whole 4,000ft paved runway to get airborne, even being towed by a 260bhp Pawnee.

I released from tow and got a feel for the day's thermals then headed for the start, which I passed through at about 8,000ft. After getting out of the valley (basically by working higher and higher up the slopes, where the inversion layer is gradually getting pushed up by the proximity of the ground) I climbed to 14,000ft over the Pine Nuts range which forms the eastern edge of the valley. This is my idea of a reasonably safe altitude to depart from the Carson Valley given the horrendous sink that you can often meet as you head south towards Mount Patterson and Mount Grant.

I worked my way down towards Mono Lake, gradually gaining height, and regretfully jettisoning my waterballast at a judicious altitude (the freezing level that day was around 16,000ft, and despite the gliding operation's use of anti-freeze I would rather not take any chances).

Then I had to decide whether to try and hop across to the Whites by the shorter route east of Mono Lake or take the longer, safer route on the Sierras to the west. The sky looked promising ahead so I took the eastern route and managed to find enough lift on my way across to reach the Whites at around 12,000ft. I took a climb there to about 16,000ft and then set off down the Whites hardly turning at all since there was such raging lift all along their western face. Mainly I had to adjust my flying speed to avoid accidentally climbing through FL180!

After getting to my turn point I headed back northwards along the Whites, following almost exactly the same path as on the way

south – having a logger is really useful for analysing flights afterwards. As I neared the northern end of the Whites I could see a horrific group of storms which had set up over Mono Lake and the area around it, with virga hanging down several thousand feet from the main cloud base. I now know that, in the summer, afternoon storms such as these are quite commonplace in the Minden region, caused by the monsoonal flow which sets up – there is a huge amount of rain but virtually none gets to the ground.

The storms were worst by the Sierras so I could see that if I was to get back to the north I would need to fly to the east of Mono Lake, in an area that still looked pretty unattractive and where, once I'd left the Whites, the next airfield I could land at (I didn't fancy Platypus Flats in the middle of nowhere with a several-hour or a day walk to get out and get a retrieve) was about

### 'I found myself under what must have been a quite active cu-nim, flying at VNE'

70km away. Talk about being committed to getting it right!

My spirits were lifted when I heard a radio call from an American glider pilot who had made it across along more or less the same route as I was planning, so I set off. I had expected there to be huge sink given the virga hanging down, but I found myself under what must have been quite an active cu-nim and I ended up flying at VNE to more or less maintain altitude. Even so I only just kept under FL180. Then I hit the sink, and eventually emerged into overcast, watery sunlight on the northern edge of the storm.

I found some weak lift on the edge of a cloud and started to climb, then decided to move a bit, quite a bit, further away when I saw lightning come out from the cloud. I flew towards Barron Hilton's ranch and airstrip, thinking that even if I couldn't find any lift I could land there. However my luck

was in and I managed to take a climb to about 16,000ft and set off for home, albeit flying a lot more slowly than on the way out.

The storms had the effect of draining most of the energy in the area and I found myself getting lower and lower around Mount Patterson; it looked like I would end up landing out after all. Then I managed one more decent climb and tiptoed back into the southern end of the Carson Valley following the line of convergence that sets up roughly in the middle there in the afternoon as air falls back down the valley sides.

I made it back to the finish and landed at Minden with a huge feeling of satisfaction at having flown the 500km, although at that point I was still wondering whether it would be invalidated by my going through FL180 – as good fortune would have it, I remained a couple of hundred feet clear. The whole flight from take off to landing took just a bit over six hours, and my average speed over the whole task was just short of 90km/h.

Since then I've made a number of abortive attempts at substantially longer distances, but one problem I can see is that flying a rented glider I can't carry enough oxygen for really long flights, since the single bottle that is fitted is only enough for about six hours. Now I need to work out how to persuade my wife that it would be a good idea not just to head out to Minden to fly but also to buy a glider for my occasional use out there!

I think Minden is a real soaring Paradise, and you learn a lot from flying in such different conditions compared to those in the UK. Since I'm still renting gliders perhaps I shouldn't say this, because it will only make it harder for me to get the better ones myself, but I really would encourage anyone contemplating a gliding holiday to head out to Minden – you'll probably get hooked, just as I've been.

Graham Turner

For more information on visiting the USA, see: [www.ssa.org](http://www.ssa.org) (Soaring Society of America) [www.usembassy.org.uk](http://www.usembassy.org.uk) (US Embassy in London)



# Gliding and UK Airspace

**Carr Withall, chairman of the BGA Airspace Committee, provides a brief assessment of 2003 and the annual reminder on airspace knowledge that all glider pilots should know**

**I**N 2003, the many airspace changes to the East of Manchester were introduced as well as the new airway from Manchester to Newcastle. These changes have greatly affected the high wave climbing areas in Yorkshire. The wave cross-country flights to the north have been assured by an agreement with Newcastle ATC.

As I mentioned last year, the next area of airspace that was to be redesigned was in the Clacton area. This was completed and came into effect on March 18, 2004. You will see from the map (*opposite*) that it is mostly high-level airspace. It does affect a couple of clubs, whose pilots will have to fly further before they can take high climbs into cloud.

The next area for redesign is to the West of London and Birmingham (The West End Development). See *Future airspace concerns* later in this article.

Last season British gliding had some very bad publicity, when – it is alleged – that on two occasions a glider infringed a Temporary Restricted Airspace (TRA) where an air display was taking place. The Red Arrows had to stop their display. There is NO excuse for this to happen when information on air displays, royal flights, and so on is readily available from several sources. The Red Arrows display programme can be seen on their web site: [www.raf.mod.uk/reds](http://www.raf.mod.uk/reds)

I know that the introduction of the new AIS website caused mass confusion but it is now more user friendly ([www.ais.org.uk](http://www.ais.org.uk)). The BGA website ([www.gliding.co.uk](http://www.gliding.co.uk)) link to Airspace gives details of how to use the site for flight planning. This together with the free Avbrief and NOTAMPLOTv2, that can be downloaded to show any area pictorially, will assist all General Aviation (GA) users to be properly briefed before flying.

The "One Sky One Day" European airspace strategy has achieved its first objective of a common upper division Flight Level of FL195. Above this level all airspace is Class C airspace. Some states made this change on November 27, 2003. The UK is unlikely to make it until November 2004. When this happens, Class B airspace will no longer exist. Our existing agreements for high flying wave areas will continue as at present. This change means that the upper airspace will start at FL195 instead of FL245 as it is today. The strategy's next objective, to achieve total controlled airspace above a lower level, possibly as low as FL95, is being strongly opposed by the UK and some other European states.

## Transponders

Following a mid air collision between two airliners over India, some years ago, ICAO

decided that every aeroplane should be fitted with a transponder. The UK has agreed that the date for all GA aircraft and gliders to be fitted with a Mode S transponder is 2008. However other European states, including France and Germany, are implementing this rule from March 31, 2005 when flying in certain designated areas – Class D airspace, for example.

The UK is developing a low power (20 watt) Mode S transponder that is suitable for gliders and this may be available by the end of this year. A full history and explanation of transponders appears on p20 of this issue.

## ICAO Airspace Classification

In November 1991 the UK adopted the new system of international airspace classification developed by the International Civil Aviation Organisation ICAO. The status of a piece of airspace is denoted by a letter which will be shown on all aeronautical charts, and it is this letter rather than the title of the airspace that will determine the rules applying to it. For example, in the UK airways will all be Class A, but in other countries they may be Class E. In order to fly within Controlled Airspace, gliders will often require legal exemptions, and the availability and nature of these will vary from country to country.

## Class A Controlled Airspace

**Cotswold CTA Daventry CTA  
London CTR London TMA  
Manchester TMA Worthing CTA  
All Airways (except where they pass  
through a TMA, CTA or CTR of lower  
status)**

As from November 6, 1997 NO airways can be crossed by gliders.

Exceptionally, gliders may cross sections of Class A airspace by virtue of a Letter of Agreement (LoA), which will have very detailed procedures to be followed. These LoA will be specific to a club operation. Camphill has an agreement for crossing airway B1. There is also an agreement for crossing airways B2 and B226 in Scotland, which applies nationally. However both these agreements require pilots to have read the detailed procedures and signed the BGA form, which MUST be given to the CFI before undertaking a crossing flight.

## Class B Controlled Airspace

The entire airspace over the UK above FL245, comprising the Upper Airspace CTA and the Hebrides Upper Control Area (UTA), is Class B Airspace.

Gliders are no longer allowed to fly in this

airspace without restriction.

Specified areas have been agreed that can be activated by clubs using the procedure for glider operations in Class B airspace. The requirement for notice of activation of these areas has been reduced to two hours.

## Class C Controlled Airspace

No UK airspace falls in this category at the time of going to press, although this is likely to change later this year (*see above*).

## Class D Controlled Airspace

All Class D airspace (formerly Special Rules Airspace) requires an ATC clearance to enter and transit this airspace. Pilots will also be flying in VMC conditions. Any pilot wishing to enter it must:

1. Contact the ATC unit and pass details of aircraft's position, level and proposed track.
2. Obtain entry clearance.
3. Listen out on the frequency whilst in that airspace.
4. Comply with ATC instructions.

The above rules apply to gliders in all Class D Areas:

**Aberdeen CTR/CTA  
Belfast CTR  
Belfast City CTR/CTA  
Birmingham CTR/CTA  
Bournemouth CTR  
Bristol CTR/CTA  
Brize Norton CTR  
Cardiff CTR/CTA  
East Midlands CTR/CTA  
Edinburgh CTR  
Glasgow CTR  
Leeds/Bradford CTR/CTA  
Liverpool CTR  
Lyneham CTR/CTA  
London Gatwick CTR/CTA  
London Stansted CTR/CTA  
London City CTR  
London Luton CTR/CTA  
Manchester CTR/CTA  
Newcastle CTR/CTA  
Scottish TMA  
Solent CTA  
Southampton CTR/CTA  
Teesside CTR/CTA**

There is a form to complete after flying through Class D airspace. All clubs do have copies. Completing this form will give the BGA and the CAA statistics on how many gliders have been granted clearances to continue their flights and identify any ATC units that may be unhelpful. There is NO restriction to asking any ATC unit in Class D for clearance to fly through their area. Most

### Clacton Airspace - ATS Routes and Airspace Below FL245

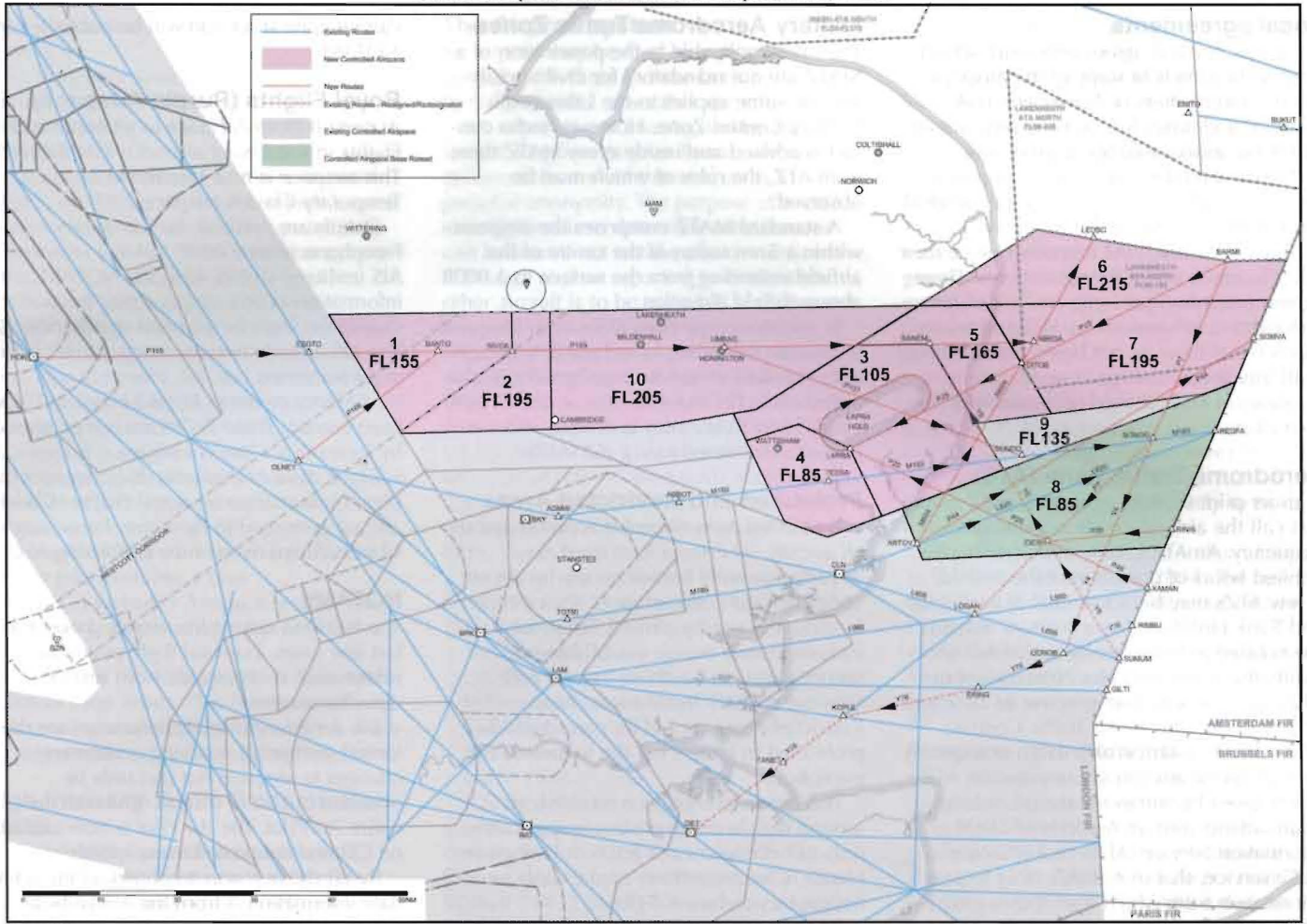

Changes to Clacton Airspace below FL245

(map courtesy of the Civil Aviation Authority)

are only "busy" for short periods usually early morning and late afternoon. Much of the traffic is transiting light aircraft or flying school traffic.

The Code of Conduct for Glider Flights through Class D airspace is still relevant as it sets out good airmanship practise.

Most pilots who have asked for clearances obtain them from helpful controllers but a few have been refused clearances. With more education and visits from pilots to their local ATC unit, clearances should become the norm.

#### Code of Conduct for Glider Flights Through Class D Airspace

With the ever-increasing size of Class D areas the need to fly through them on cross-country flights will occur more frequently. Pilots can ask for a clearance to fly through ANY Class D airspace. The code set out below is a guide to good airmanship practise.

1. Glider pilots should plan to route their flights through Class D airspace when it is clear that there are advantages from so doing, such as better weather and shorter track distance.
2. Flights should try to spend the minimum time in Class D airspace. Pilots should avoid

circling on or close to the runway extended centre lines, since this may well interfere with departing or arriving traffic.

3. Keep the controller informed if, for any reason, such as massive sink, you have to change your planned course.
4. Good lookout is vital at all times, and glider pilots should be prepared to initiate avoiding action notwithstanding their right of way priority. Gliders are not always visible on radar.
5. Competition tasks should NOT be set through Class D airspace. Where a task leg has to be set close to Class D airspace the ATC unit should be informed. When possible, control point(s) should be established, to help ensure that gliders remain outside the airspace.

#### Class E Airspace

The Belfast TMA and parts of the Scottish TMA are notified as Class E and permit all aircraft (including gliders) to fly in this area without ATC clearance subject to maintaining VMC.

#### Class F Airspace

An Advisory Route (ADR) is a route used by airline type traffic without the full protection

of an airway. Although depicted only as a centreline on UK aeronautical charts it is nominally 10nm wide. Gliders may cross Class F airspace without restriction but caution should be exercised.

#### Class G Airspace

This is the term given to the "open" FIR (Flight Information Region), which is the uncontrolled airspace not subject to any of the previous classifications. Within Class G airspace there are various non-ICAO types of airspace, which are described below. Within Class F and G airspace aircraft are separated on a purely see and be seen concept. If requested, a flight information service (FIS) may be provided by civil and military ATC units. Most small light aircraft talk to whoever will listen as they fly around the country.

#### Visual Meteorological Conditions (VMC)

VMC conditions for Class D, E and in the open FIR below FL100 are: that an aircraft shall remain 1,000ft vertically, and 1,500 metres horizontally from cloud in a flight visibility of 5km. Below 3,000ft AMSL an aircraft shall remain clear of cloud in a flight visibility of 5km and in sight of the ground. Additionally when flying in the Open FIR below 3,000ft and below 140kt flight is permitted in flight visibilities of 1,500 metres.

## Local agreements

A number of local agreements exist, which modify the effects of some of the airspace listed above. Letters of Agreement (LoA) between a gliding club and a nearby airport can make airspace either more or less restrictive than described above, depending on circumstances. These arrangements are too numerous to list in full.

Clubs that have LoAs must encourage their pilots to make use of the agreements. These agreements take up a large amount of time and effort to achieve and if ATC authorities can see that they are not being used then we shall lose them. Use it or lose it!

Copies of LoAs should be available from your club.

## Aerodrome Traffic Zone (ATZ)

A glider pilot wishing to enter an ATZ must first call the airfield on the notified radio frequency. An ATZ is only active during the notified hours of operation of the airfield. A few ATZs may be active only at weekends and Bank Holidays. Many military airfields are notified as permanently active though in reality this is not the case. Nonetheless the ATZs must be regarded as active at all times. At an airfield with an Air Traffic Control (ATC) unit, that unit is able to give or refuse permission for any aircraft to enter the ATZ and to give clearances to take-off or land. At an airfield with an Aerodrome Flight Information Service (AFIS) or Air/Ground (A/G) service, that unit is able only to pass information from which a pilot may judge whether or not it is safe to enter the ATZ or to take-off or land; in other words, the unit cannot issue clearances or withhold permission.

The following categories of airfield are protected by an ATZ: Government aerodromes and licensed aerodromes with one of the above types of service.

The ATZ comprises the airspace extending from ground level to 2,000ft above the level of the aerodrome and within a radius of 2 or 2.5nm of the centre of the aerodrome, depending on the length of the main runway.

At airfields without ATZs, including most gliding sites, regardless of how busy they are, a itinerant aircraft may legally penetrate the airspace near and over the airfield, provided that the pilot conforms to the traffic pattern or keeps clear of the circuit airspace, and observes the normal rules of good airmanship to avoid conflicting with other aircraft.

For landing at airfields with or without ATZs, it should be noted that many are listed in the UK Air Pilot as "PPR", "PPR to non-radio aircraft" or even "not available to non-radio aircraft". PPR (Prior Permission Required) means that landing permission must be obtained in advance of the flight, for example, by telephone. All military airfields are effectively PPR and will not permit landings by civil aircraft except where they have been pre-arranged, or in an emergency.

## Military Aerodrome Traffic Zones

The rules applicable to the penetration of a MATZ are not mandatory for civil aircraft and the same applies to the Lakenheath Military Control Zone. However, radio contact is advised and inside every MATZ there is an ATZ, the rules of which must be observed.

A standard MATZ comprises the airspace within a 5nm radius of the centre of the airfield extending from the surface to 3,000ft above airfield elevation.

In addition, projecting stubs 5nm long and 4nm wide extending from 1,000ft to 3,000ft above airfield elevation are aligned with the approach to the main runway at one or both ends. Some MATZ may lack stubs or form part of a combined MATZ (CMATZ)

## Prohibited and Restricted Areas

A Prohibited Area (P-prefix) is prohibited to all aircraft, whereas a Restricted Area (R-prefix) permits limited access by aircraft under defined circumstances, for example, landing at a nearby airfield. These areas include atomic energy establishments, security areas in Northern Ireland and sensitive military installations. Most Restricted Areas should be considered as prohibited to gliders but the following are exceptions:

The Restricted Airspace established around high security prisons is applicable only to helicopters and R105 at Highgrove House, Gloucestershire, applies only to helicopters and microlights.

R313 at Scampton exists for the purpose of protecting the Red Arrows' display training. The area is a circle of 5nm radius extending to 9,500ft amsl and active only during Scampton's normal operating hours, which are weekdays and as notified by NOTAM. During these times, a glider may enter the area by permission of ATC Waddington.

## Temporary Restricted Airspace

Major air displays such as Farnborough or the International Air Tattoo (IAT) display at Fairford are protected by Temporary Restricted Airspace (TRA).

This year the IAT is again at RAF Fairford on July 17-18, 2004. Be aware that Friday 16 and Monday 19, when the aircraft arrive and depart, are almost as busy as the show. Farnborough Air Show is from 19-25 July 2004.

Local gliding clubs usually negotiate limited access routes to and from their sites to enable non-radio gliders to continue operating but a glider equipped with suitable radio may fly in the area if it contacts the ATC unit designated by the NOTAM as the controlling authority.

Other types of Temporary Restricted Airspace are effectively closed to gliders. They are established to protect Red Arrows displays throughout the country, plus major flypast formations, over events of political significance and over the sites of major disasters. The duration and extent of the restriction

can be quite short and will be published by NOTAM.

## Royal Flights (Purple Airspace)

At certain times Airspace to protect Royal Flights in fixed wing aircraft is established. This airspace is now referred to as Temporary Class A airspace.

Details are available by using the Freephone service 0500 354802 or from AIS (military) 01895 426153. NOTAM information of this airspace may be available should the flight be planned in advance. The AIS website ([www.ais.org.uk](http://www.ais.org.uk)) will have this information.

NOTAMs covering Royal helicopter flights have ceased. These flights are not protected by Temporary Class A airspace.

Clubs should telephone daily in order to obtain information on Royal Flights. Gliders are not permitted to fly within Temporary Class A Airspace, even by contacting ATC.

## NOTAMs

The NOTAM system has changed over the last few years. Essential flight planning information is obtainable from several different sources.

UK Air Pilot AIRAC Supplements are the formal method of notifying permanent changes to airspace but can only be obtained as part of a subscription to the entire *Air Pilot*. The *Air Pilot* is now available on CD and is updated every month.

By far the best way to obtain all the up-to-date information is from the AIS website ([www.ais.org.uk](http://www.ais.org.uk)).

## Danger Areas

The UK is covered with Danger Areas of many types, shapes and sizes. They are active part-time, permanently or when notified by NOTAM. Full details will be found in the UK Air Pilot, RAC Section. The chart of UK Airspace Restrictions is also useful.

The UK Air Pilot lists only the type of activity most likely to be encountered, but in practice various hazards may be encountered when manoeuvring outside the confines of the Danger Area especially if it is a Weapons Range Danger Area.

Many Danger Areas contain areas over which flight is prohibited at times within the period of activity of the Danger Area by reason of bye-laws made under the Military Lands Act 1892 and associated legislation.

It is also worth noting that the UK Air Pilot does not list Danger Areas with upper limits 500ft or less above the local surface, to which prohibiting bye-laws may also apply.

With these exceptions, flight through a Danger Area is not prohibited, but may be foolhardy.

For certain Danger Areas, a Danger Area Crossing Service, most notably for Salisbury Plain, is available, call Salisbury Plain Control on 122.75Mhz. A Danger Area Activity Service is available in other cases: this should be viewed as a means of establishing the state of activity of a Danger

Area at a particular time, not as a clearance to cross it.

A convenient summary of these two services and the ATC units to contact is printed at the foot of the 1: 500 000 series CAA charts.

Particular care should be taken to avoid Weston on the Green (D129), which is used extensively for military paratroops training. Brize Radar (on 134.3) will confirm activity status.

## Parachuting

There are many sites around the country and a few operate every day and are extremely busy. The list of parachute sites and the appropriate contact ATSU/AC for transit information is on the maps.

The airspace is contained in a circle radius 1.5 or 2nm from the centre of the drop zone up to a maximum of FL150.

*You will NOT see a free fall parachutist in time to take avoiding action.*

The BGA website's Airspace section has a link showing all parachute sites and radio frequencies.

NOTE: This list adds another 0.5nm to the radius of drop zones. This is for pilots flying with moving map displays to receive a warning when within 0.5nm of a drop zone.

## High Intensity Radio Transmission Areas

These contain powerful radio emissions, which may cause interference with glider radios, electric variometers, electronic barographs and loggers. In particular Fylingdales is so powerful that prolonged exposure may be injurious to health.

## Areas of Intense Aerial Activity

An AIAA is airspace not otherwise protected by regulated airspace but where the activity of civil and/or military flying is exceptionally high or within which aircraft regularly participate in unusual manoeuvres.

Gliders may penetrate these areas but in view of the hazards, a sharp lookout is essential.

## Military Low Flying System

Low flying by high performance military aircraft takes place in most parts of the UK up to 2,000ft agl, with the greatest concentration between 250ft and 500ft. A chart is available denoting the system (*UK Air Pilot*, RAC Section).

Most gliding sites are notified to the Ministry of Defence, which affords them the status of a Military Avoidance Zone, usually with a radius of 1.5nm.

## Radar Advisory Service Area

A RASA is an area of airspace in which a pilot may, if he/she so chooses, avail him/herself of the services of a radar unit.

There is no requirement to do so, and a glider pilot should not assume that other aircraft are being separated from him, nor even that the radar unit is aware of the glider's presence.

## The Airprox system

An airprox may be filed by a pilot who considers his flight to have been endangered by the proximity of another aircraft.

All airproxes are investigated by the United Kingdom Airprox Board, whose deliberations are confidential so as to preserve anonymity. The purpose of a UKAB investigation is to determine what lessons can be learnt, not to take punitive action.

Prompt airprox reporting is vital if the other aircraft is to be traced. If in radio contact with an ATC unit report to them at once, or if this is not possible, telephone soon after landing. Call AIS (MIL) at LATCC West Drayton on 01895 426153, who will start tracing action at once and inform the UKAB. Follow this up with a written report on form CA1094 to the UKAB within seven days. Always use GMT (UTC is the same) in reports. Every club has been issued with this form.

UKAB can be contacted in working hours on 01895 815125 or fax on 01895 815124. Their address is:

The Director,  
UKAB,  
Hillingdon House,  
Uxbridge,  
Middlesex,  
UB10 0RU.

If filing an Airprox or if you suspect one may be filed against you then please also contact the following BGA contacts: Bruce Cooper [bruce.cooper68@virgin.net](mailto:bruce.cooper68@virgin.net) or Carr Withall 01442 862577. If carrying a logger please keep the trace. The use of traces may well provide evidence against exaggerated claims.

## Use of radio

A glider pilot possessing a radio operator's licence (R/T Licence) is entitled to use all the available aeronautical frequencies of a 760-channel radio. This permits seeking access to the following types of airspace that may be otherwise closed to gliders: the new Class B airspace areas, any Class D airspace and Aerodrome Traffic Zones, and some types of permanent and Temporary Restricted Airspace and some Danger Areas.

Radio cannot be used to request entry clearance into Class A airspace (except by special arrangement).

All clubs have a copy of where and with whom one can take the R/T licence test. The licence will be valid for ten years.

## Future airspace concerns

As mentioned earlier, the next major change is the redesign of much of the controlled airspace to the west of London and Birmingham. These changes are due to take place in March 2006.

Bristol and Cardiff are requesting more controlled airspace and an extension to the airway parallel to A25 over Wales is planned. The base of Airway A25 is to be raised. All the clubs affected are actively involved.

East Midlands airport's proposed expansion

to the Class D airspace has been delayed until the end of this year.

Edinburgh plans to change most of their local airspace from Class E, no radio, to Class D. Meetings with Edinburgh ATC have been very constructive and friendly.

## Maps

There is much useful information at the bottom and side of CAA charts that can greatly assist on cross-country flights: for example, ATZ frequencies, parachute site contact frequencies, Danger Area activity and so on.

With ever increasing numbers of gliders and light aircraft flying around it is essential to use every bit of airspace possible. This can only be achieved if the correct frequency is immediately to hand when you wish to inform airfields that you are likely to fly over or through their zone.

The new Southern UK half-million Edition 30 is due out on April 15, 2004. The new Northern UK Edition 27 is due out on May 13, 2004.

See the BGA website ([www.glidering.co.uk](http://www.glidering.co.uk) Airspace, Charts) or the advert on page 6 of this S&G for a complete listing.

## Airspace infringements

If due to the difficulty of trying to stay airborne one drifts into controlled airspace then PLEASE call the ATC unit and apologise giving your good reason for the intrusion. They DO NOT CARE if you do not have an R/T licence but they DO CARE if the airspace that is in their control is infringed. With the requirement to obtain an R/T licence to fly within Class D airspace, pilots should become more confident to talk to other airfields that they may be flying close by. A brief courtesy call is welcomed by most controllers and will reinforce the position that we are "professional" pilots.

## Finally, if you're lost,...

Remember if you are truly lost and worried about infringing controlled airspace call on the distress frequency 121.5. This service can very quickly find an aircraft as long as it is about 2-3,000ft and South of Manchester.

## References

The information in this article is only a brief synopsis of the airspace rules as they affect glider pilots and is believed to be accurate at the time of writing. In case of doubt authoritative references should be consulted. These are:

Air Navigation Order 1989;  
Rules of the Air Regulations 1991;  
UK Air Pilot, RAC section.

BGA Laws and Rules, 14th edition, June 2003, reflects the current legislation.

Abbreviations. CTA = Control Area, CTR = Control Zone, TMA = Terminal Manoeuvring Area (the lower limit of a CTA or TMA is an altitude or flight level above the surface, whereas a CTR extends to ground level)



*MOUNTAINS high are a major element of the soaring scenery on RAFGSA expeditions to France and Chile. Carl Peters takes his camera with him when he joins them, and this page shows the results.*

*Above: Carl took this shot of an Italian glider while he was flying in a Janus near the gliding site of Flieti, the exped was based at Sisteron in the French Alps*

*Left: The imposing scenery over the Aconcagua and Colorado River Valleys, seen from 12,000ft. A good climb here gives you access to the bigger mountains.*

*Below: it all looks considerably more daunting from here – a Janus glider, flown by Paul McLean, goes “down amongst the rocks” to use the best lift close to the slope*





# Mountain high, valley low

*OKAY, at around 700ft AMSL it's not exactly a mountain, but Dave Bland of the Bristol & Gloucestershire GC recorded these magnificent views across the valley below his home site, Nympsfield, at the end of 2003.*

*Above: looking over the Severn Valley towards Wales  
Top right: the picture from Nympsfield, looking down the Cotswold edge towards Bath. In other weather, this is part of the long ridge used on winter cross-countries*

*Right: the hilltop club, on the escarpment, with its line of white trailers visible in front of the treeline and the fog*



*Below: back to the mountains, with Richard Bennett's latest pictures from his regular trips to the Austrian Alps*

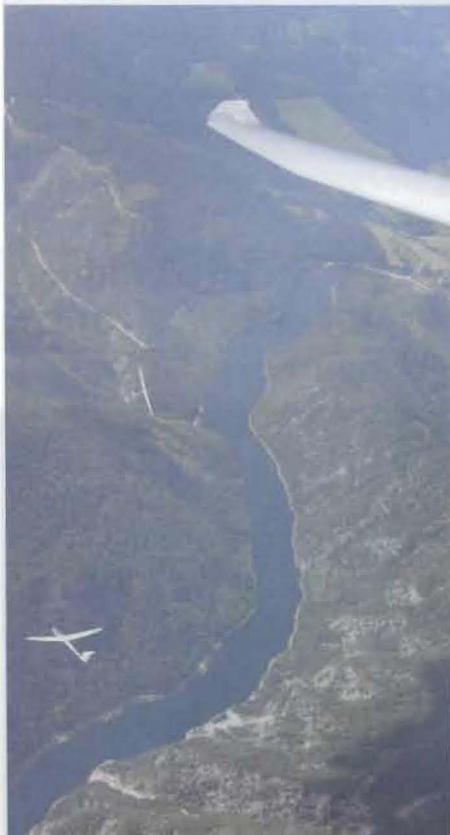

# The Black Mountains Gliding Club

**MAKE 2004 YOUR YEAR - COME TO TALGARTH**

Average flight times in excess of 1 hour means you can really get some air time.

Courses available:

- ab-initio consolidation training, accelerate your club training.
- solo to bronze get solo at Talgarth, aerotow training, get your bronze legs, and ground school prior to sitting the paper.
- Advanced hillsoaring courses.
- Mountain wave flying.

The club operates 7 days a week from Easter.

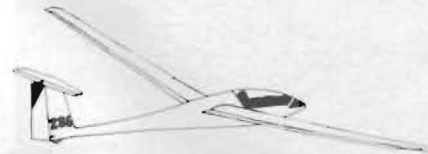

For more details:- Visit our web site [www.talgarthgc.co.uk](http://www.talgarthgc.co.uk) E mail (Preferred) [blackmountainsglidingclub@hotmail.com](mailto:blackmountainsglidingclub@hotmail.com) Telephone 01874 711463



## Tasman Instruments

## V1000 Vario



- No flask - simple to install 2.25"
- Digital audio LCD display with average
- Digital differentiation for precise response
- Variable response speed
- Inbuilt speaker
- Low power consumption
- Voltmeter display
- Repeat display for two seat installation available

Special introductory price **£315.00** inc. VAT from

### SOUTHDOWN AERO SERVICES LTD

0044 (0) 1256 381359 • 0044 (0) 1256 381816

E-Mail: [info@southdownaero.com](mailto:info@southdownaero.com) • [www.tasmaninstruments.com.au](http://www.tasmaninstruments.com.au)

fly the Vale of York



# Thermal Wave

- Brilliant site
- Tarmac & grass runways
- No airspace restrictions
- 2 Pawnee tugs
- 2 winches
- 3 x 2 seat training gliders
- 3 x single seat
- 2 motor gliders for faster glider training
- Approved site for glider pilot NPPLSLMG
- Plenty of caravan and trailer spaces
- Full time staff 7 day operation
- 5 day courses £330
- fixed price to solo £895 (winch & aerotow)

**Rufforth Airfield, York Tel: 01904 738694** [www-users.york.ac.uk/~mdc1/ygc.html](http://www-users.york.ac.uk/~mdc1/ygc.html)

**York Gliding Centre**



## BALTIC SAILPLANES

SOLE UK AGENTS FOR SPORTINE AVIACIJA

LAK 19 Standard/18m Class  
Sailplane  
Available with Turbo (Solo Engine)

For details contact:

**Tony Pozerskis or Ron Bridges**

Tel: 01858 468820 or 01327 857636 • Fax: 01327 857636  
e-mail [tony.poz@virgin.net](mailto:tony.poz@virgin.net)



# FUENTEMILANOS AIRFIELD SEASON 2.004

**Where a Ka.6 can do 750 Km.? JUST IN FUENTE!!**

Here you can fly High on the mountains with the safety of the planes!!  
Every 20 miles we have an alternative airfield!

Professional Staff!

Gliders for Rent: G-103, G-102, LS.7, ASW19 b, DISCUS b, NIMBUS 4DM. Even  
with English Speaker Instructors.

Daily Briefing with Weather Info, help for beginners, ... In English.

Campsites and Bungalows on side, Hotels nearby the area and close to  
Segovia (10 miles) Tourist Town. Madrid Airport not far than 50 miles.

VISIT OUR WEB PAGE:

[www.fuentemilanos.com](http://www.fuentemilanos.com) for prices and details

e-mail: [Fuentemilanos@fuentemilanos.com](mailto:Fuentemilanos@fuentemilanos.com); [info@fuentemilanos.com](mailto:info@fuentemilanos.com)  
phone+34921426963 • fax : +34921426963

## EW Avionics



**The EW "D type"**

**IGC approved flight recorder.**

**Just £295 plus VAT and delivery.**

IGC approval for use with the most popular Garmin GPS receivers.  
Comes with DOS software and all you need to connect to your GPS and  
computer. Ideal for competitions and badge claims up to Diamond C.  
Incorporates the following features: 24 hours of recorded position and  
height data at a 4 second sample rate, motor and pilot event ports,  
electronic declaration, 9-16 volt external power input and 9 volt internal  
battery giving up to 40 hours stand alone recording time, standard  
electronic barograph with 15Km altitude range and 5m altitude  
resolution, user selectable sample intervals from 1 to 999 seconds,  
extremely robust and simple 1 button start up routine.

Looking for a Windows software program which can  
upload your EW unit, analyse IGC format files as well  
as task set, upload your Garmin logs and download  
your TP's to your Garmin? Look no further than the  
tried and tested EWView3 for Windows program.  
Free trial disc set available on our web site.

Just £ 49.95 inc. VAT & p&p

## Upgrades

Upgrade your existing Model A & B GPS recording  
units to the latest IGC approved FR specs  
£ 75.00 + VAT inc. of servicing and 2 year calibration  
certificate.

Upgrade + Calibration + EWView3 £95.00+ VAT

Visit our comprehensive web site

[www.ewuk.co.uk](http://www.ewuk.co.uk)

or phone us to get more information  
about any EW products.

**EW Avionics, Seymour Barn, Widmere Lane, Marlow SL7 3DF, England.**

**E-mail [ew@ewuk.co.uk](mailto:ew@ewuk.co.uk) - Phone & Fax 01628 477999**



## Glide Navigator II

Soaring Software for Pocket PCs  
by Chip Garner



### Cambridge Aero Instruments

- 302 - Vario/Speed-to-fly/GPS/Logger
- 302A/CFR - IGC Approved GPS/Flight Recorder
- 303 - Nav. Display for 302/302A with final glide



### Software for Pocket PCs

- Glide Navigator II
- Flight Analysis
- VL (Volkslogger) to IGC



### Modular Cable & Power Systems



### Mounts for Pocket PCs and GPSs

### GPSs for Pocket PCs



- Moving map
- Final glide
- Reachable airports highlighted
- Automatic wind calculation
- Turnpoint Area Task support
- Improved menu navigation
- Optimized for in-flight ease-of-use
- Large "finger sized" buttons
- Record unofficial IGC flight log files
- Final glide around multiple turnpoints
- FAI photo sectors displayed
- Compatible with any GPS
- Used by top competition pilots
- Perfect for new cross-country pilots
- Free upgrades for 1 year
- \$200 (£120)

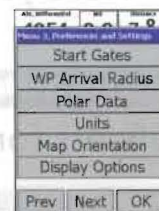
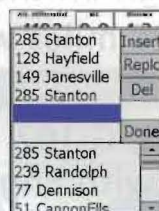

[www.cumulus-soaring.com](http://www.cumulus-soaring.com) • [paul@remde.us](mailto:paul@remde.us) • 1-952-445-9033 • Minnesota • USA



## Adventure & Excitement with every flight

There is no such thing as an ordinary flight at Aboyne; just year-round soaring over the most spectacular scenery in the UK. Significant X-country flights are possible every month. On-hand is local, expert advice together with our enhanced out-landing database, we'll help you get the most out of the day.

For the less experienced we offer individually tailored courses and holiday courses at times to suit.

Launch queues are unknown (outside our 'Visitor' Season) and we have a superbly fitted glider fleet available, if you can't bring your own.

For the non-flying members of your party there is a wealth of activities in the area offering adventure & excitement of a more terrestrial nature!

We look forward to welcoming you to Aboyne in 2004.

**UK Mountain Soaring Championship 5th-11th September 2004**  
(The competition with Altitude!)

**September and October 2004 (only):**

Mary-Rose: 01569 730687

**All other enquiries:**

Roy Ferguson-Dalling: 013398 85339 or

e-mail: [deeside@glidingclub.co.uk](mailto:deeside@glidingclub.co.uk)



# www.szdujezow.com.pl

**We offer the following services**

**Manufacture & sale of approved spare parts for all SZD gliders.**

**Inspection of & accident damage repairs to all makes of gliders – in particular major overhauls & life span extensions of the SZD-9bis Bocian 1D & E, SZD-36 Cobra, SZD-24C Foka, SZD-30 Pirat, SZD-50-3 Puchacz and the SZD-51-1 Junior.**

**Cosmetic work.**

We hold the following: BGA No. I/A/1288, P-035 JAR 21/subsection G and D-11/JA/2001/subsection JA. • We issue BGA Certificates of Airworthiness. • Our work is fully guaranteed, at highly competitive rates and delivered on time. • We are located in Polish Lower Silesia – near the German border at pre-war Grunau (home of the Grunau Baby), with easy road access to the factory.

### UK Contact:

Stan Kochanowski on: +44 (0) 1623 64 88 91, Fax: +44 (0) 1623 43 78 22, Mobile: 07944 94 12 74 or e-mail [stanislaw.kochanowski@ntlworld.com](mailto:stanislaw.kochanowski@ntlworld.com)

### Contact in Poland:

"Jezów" Glider Works (ZS "Jezów") – owner, Henryk Mynarski +48 (0)33 812 50 27 or e-mail [szd\\_bielsko@szdujezow.com.pl](mailto:szd_bielsko@szdujezow.com.pl)



## Learn to Soar at the Yorkshire Gliding Club

*The Best Soaring Centre in the North of England*

- Professional 7 day a week operation
- Fantastic modern fleet with a brand new DG1000
- 5 day courses & One Day Introductory Intensive Courses

*Places still available in the NORTHERN REGIONALS*

*Entry Fee ONLY £100 (£75 for Juniors)*

[www.the-northerns.co.uk](http://www.the-northerns.co.uk)

**THE YORKSHIRE GLIDING CLUB**

Sutton Bank, Thirsk, North Yorks. YO7 2EY • 01845 597237  
enquiry@ygc.co.uk • www.ygc.co.uk

## ZULU GLASSTEK LTD

*SOLE UK AGENT TO ALEXANDER SCHLEICHER AND SILENCE FLUGZEUGBAU • SALES, SPARES AND REPAIRS*

*All Schleicher Gliders are manufactured entirely in house by hand at Poppenhausen as they have been for 75 years*

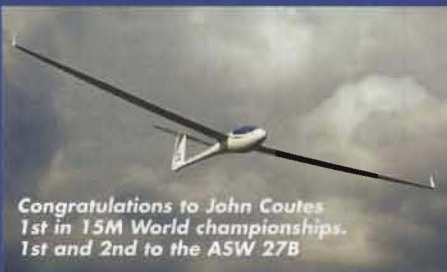

*Congratulations to John Coutes  
1st in 15M World championships.  
1st and 2nd to the ASW 27B*



*Gerhard's latest creation the ASW28/18*

*Silence Aircraft  
TWISTER  
+/-10 G,  
derig-able  
single seater  
available  
with Cobra  
trailer, first 2  
kits in UK*



*If you wish to buy one of these or one of the many other Alexander Schleicher gliders and motor gliders, contact:*

**Zulu Glasstek Ltd., Peter & Sally Wells, Baileys Farm, Westfield Road, Long Crendon, Bucks HP18 9EN**  
Tel: Pete/Workshop 01844 208157 • Office/Fax: 01844 201028 • email: [zuluglasstek@clara.net](mailto:zuluglasstek@clara.net)

## TaskNAV v2.4 .. from **£45**

- V2.4.116 – comprehensive top function gliding software.  
Full product is available by internet download or on CD. It provides quality topographic vector mapping (worldwide gliding coverage). The CD includes hundreds of racing flight examples by top pilots.
- **Download** from web site [www.tasknav.com](http://www.tasknav.com)  
Upgrades £39  
Full product £45
- **On CD** including post and pack  
Full product £55.
- TaskNAV is World Championships and World Air Games proven.  
Suitable for all pilots.

Contact: D J Robertson

20 Duffield Lane, Stoke Poges, Bucks SL2 4AB

Tel: 01753-643534 E-mail: [RobertsonDJ@Compuserve.Com](mailto:RobertsonDJ@Compuserve.Com)



# ANNUAL STATISTICS

GLIDING CLUBS	AIRCRAFT				ALL LAUNCHES	NO. OF AEROTOWS	HOURS FLOWN	KMS FLOWN	MEMBERSHIP		
	Club 2s	Club 1s	PO	Tugs					Full Flying	Estimated No. of Temporary Members	No. of Female Members
Andreas Gliding Club	1	0	5	0	342	52	69	0	19	32	0
Angus Gliding Club	3	1	4	0	537	0	102	0	11	2	0
Aquila Gliding club	3	3	25	2	1312	1312	934	5176	66	360	3
Bath Wilts & North Dorset Gliding Club	4	3	30	1	3490	979	1705	11375	121	230	9
Bidford Gliding Centre	3	3	45	0	2949	2649	0	0	89	604	3
Black Mountains Gliding Club	2	1	32	1	2176	2176	2611	0	79	447	5
Booker Gliding Club	8	9	86	5	9175	9175	0	0	233	1500	34
Borders Gliding Club	3	2	34	2	2132	2048	1961	0	104	65	4
Bowland Forest Gliding Club	3	4	30	0	5409	0	2126	0	141	387	13
Bristol & Gloucestershire Gliding Club	4	4	67	2	4893	1813	3587	0	206	475	17
Buckminster Gliding Club	3	2	22	1	3309	2007	1829	4010	74	241	5
Burn Gliding Club	5	3	31	1	5668	1474	2309	9200	121	571	7
Cairngorm Gliding Club	2	0	11	1	998	880	929	600	36	79	3
Cambridge Gliding Club	4	5	68	2	10080	2742	6800	223000	239	1629	17
Carlton Moor Gliding Club	1	1	0	0	458	0	70	0	9	43	0
Channel Gliding Club 2002	2	1	6	0	1827	0	217	0	41	249	3
Connel Gliding Club	2	0	7	0	0	0	0	0	4	0	0
Cornish Gliding Club	2	2	6	1	928	738	363	0	36	261	1
Cotswold Gliding Club	4	4	47	0	8366	219	3164	0	177	666	10
Crown Services	1	2	4	0	116	100	39	0	14	0	2
Dartmoor Gliding Society	2	2	11	0	2311	0	616	850	58	151	6
Deeside Gliding Club	3	3	16	2	3958	3958	4452	63370	84	471	12
Denbigh Gliding Centre	3	1	15	0	3790	150	1650	3500	50	96	4
Derby & Lancs Gliding Club	4	3	41	0	5775	0	2545	5500	167	569	7
Devon & Somerset Gliding Club	4	1	43	1	6271	532	2317	8806	186	361	22
Dorset Gliding Club	2	2	12	1	1583	351	509	0	38	161	2
Dukeries Gliding Club	2	2	11	0	2023	19	344	1500	38	168	4
Dumfries & District Gliding Club	1	1	2	0	366	0	100	200	12	13	0
East Sussex Gliding Club	4	4	17	1	3892	935	1387	9854	105	599	7
Essex & Suffolk	4	3	21	0	5055	15	2163	30225	115	275	7
Essex Gliding Club	4	3	26	1	2782	670	1096	0	94	335	5
Herefordshire Gliding Club	1	1	8	1	685	685	510	0	23	75	1
Highland Gliding Club	1	1	15	0	1898	743	352	0	44	101	5
Imperial College Gliding Club	1	2	0	0	506	135	199	0	25	23	3
Kent Gliding Club	4	3	36	1	7021	1280	2200	0	173	787	18
Lakes Gliding Club	2	1	11	1	671	661	384	0	34	47	1
Lasham Gliding Society	11	0	150	5	25000	10000	0	0	535	2186	29
Lincolnshire Gliding Club	3	1	7	0	2259	0	377	1987	50	121	3
London Gliding Club	7	5	127	4	17889	8927	7128	278000	262	2054	12
Mendip Gliding Club	4	2	10	1	2693	72	708	2500	71	274	4
Midland Gliding Club	4	4	39	1	9683	615	4726	16437	178	501	9
Needwood Forest Gliding Club	3	2	9	0	2629	0	741	0	52	255	6
Nene Valley Gliding Club	3	2	18	0	3259	10	1006	2499	61	202	6
Newark & Notts Gliding Club	3	4	10	0	3734	84	929	2780	65	319	6
Norfolk Gliding Club	3	3	49	2	4277	2404	2295	71000	127	326	8
North Devon Gliding Club	2	0	8	0	996	996	0	0	13	270	1
North Wales Gliding Club	2	2	4	0	1030	0	160	0	27	72	0
Northumbria Gliding Club	3	2	12	1	2614	625	681	1000	88	462	5
Oxford Gliding Club	4	4	24	0	4369	0	1318	6000	90	405	12
Oxfordshire Sportsflying Club	0	0	7	0	0	0	1450	18000	56	15	3
Peterborough & Spalding Gliding Club	3	2	33	2	2236	2236	1685	0	67	448	8
Rattlesden Gliding Club	3	2	2	0	3214	541	1276	4500	83	352	13

# OCTOBER 1, 2002 TO SEPTEMBER 30, 2003

GLIDING CLUBS	AIRCRAFT				ALL LAUNCHES	NO. OF AEROTOWS	HOURS FLOWN	KMS FLOWN	MEMBERSHIP		
	Club 2s	Club 1s	PO	Tugs					Full Flying	Estimated No. of Temporary Members	No. of Female Members
Sackville Gliding Club	2	3	8	0	250	225	245	0	15	13	1
Scottish Gliding Union	4	4	52	1	9787	1076	5060	0	263	618	13
Shalbourne Soaring Society	3	3	30	0	4251	58	1358	7000	84	374	9
Shenington Gliding Club	3	4	41	0	9203	879	2200	0	174	450	19
Shropshire Soaring Group	0	0	8	1	195	195	297	2600	17	0	1
South Wales Gliding Club	2	4	31	1	2985	888	1625	16000	78	211	4
Southdown Gliding Club	3	3	54	3	4680	3966	3618	43386	176	681	20
Staffordshire Gliding Club	3	4	20	0	3768	738	1503	8000	108	272	10
Stratford On Avon Gliding Club	4	3	27	0	6473	0	2280	24945	114	619	13
Strathclyde Gliding Club	1	1	6	0	220	0	21	0	11	28	0
Surrey & Hants Gliding Club	0	12	0	0	0	0	0	0	112	6	5
Surrey Hills Gliding Club	4	3	5	0	4929	0	665	0	85	487	4
The Motor Glider Centre	0	0	0	0	0	0	205	2000	18	0	1
The Soaring Centre	6	6	97	3	10913	6870	6194	35156	307	1214	22
Trent Valley Gliding Club	3	2	19	1	3655	712	1439	0	66	229	4
Ulster Gliding Club	3	2	17	2	1657	1600	1060	800	65	218	5
Upward Bound Trust Gliding Club	2	1	5	0	1456	0	427	177	23	30	3
Vale of Neath Gliding Club	2	1	3	1	185	169	137	0	17	6	1
Vale of White Horse Gliding Club	2	2	10	1	1155	975	839	7650	45	126	3
Vectis Gliding Club	2	1	6	1	706	706	242	0	33	82	4
Welland Gliding Club	3	4	20	0	2380	356	952	7332	59	3	7
Wolds Gliding Club	4	2	41	2	8724	1355	3248	4560	184	1050	5
York Gliding Centre	5	3	28	2	5138	3615	2003	10000	188	1059	12
Yorkshire Gliding Club	5	5	48	3	5259	3861	4479	112582	184	615	9
<b>SECTION TOTALS</b>	<b>226</b>	<b>191</b>	<b>1930</b>	<b>66</b>	<b>286603</b>	<b>93252</b>	<b>114216</b>	<b>1064057</b>	<b>7317</b>	<b>28726</b>	<b>540</b>
<b>CLUB TYPE: SERVICE</b>											
Anglia Gliding Club	3	3	1	0	2204	3	505	1540	51	0	0
Bannerdown Gliding Club	4	3	19	0	5112	37	2150	6856	89	318	10
Chilterns Gliding Club	2	3	14	0	4607	17	1612	6053	97	369	0
Cleveland's Gliding Club	2	3	11	2	1530	916	1100	12000	52	40	4
Cranwell Gliding Club	3	3	15	1	3838	389	1463	7515	58	287	8
Crusaders Gliding Club	3	1	1	0	2603	10	366	0	36	1	3
Fenland Gliding Club	2	2	4	0	1641	6	532	3500	28	167	1
Four Counties Gliding Club	3	3	10	1	3894	524	1840	28302	42	13	2
Fulmar Gliding Club	2	1	2	1	271	183	139	540	16	27	4
Heron Gliding Club	2	2	5	0	1341	33	396	0	30	50	4
Kestrel Gliding Club	2	2	5	0	1381	0	457	9965	24	108	0
Portsmouth Naval Gliding Club	6	5	18	3	6322	2088	1440	17256	208	663	9
RAF GSA Centre Bicester	5	5	31	3	11534	4870	7335	103000	106	448	10
Seahawk Gliding Club	3	3	4	1	1932	1210	419	300	46	233	3
Wrekin Gliding Club	3	4	6	1	2604	731	864	5500	82	0	6
Wyvern Gliding Club	3	3	7	0	6753	111	1789	9943	59	108	3
<b>SECTION TOTALS</b>	<b>48</b>	<b>46</b>	<b>153</b>	<b>13</b>	<b>57567</b>	<b>11128</b>	<b>22407</b>	<b>212270</b>	<b>1024</b>	<b>2832</b>	<b>67</b>
<b>CIVILIAN CLUB TOTAL</b>	<b>226</b>	<b>191</b>	<b>1930</b>	<b>66</b>	<b>286603</b>	<b>93252</b>	<b>114216</b>	<b>1064057</b>	<b>7317</b>	<b>28726</b>	<b>540</b>
<b>GRAND TOTAL</b>	<b>274</b>	<b>237</b>	<b>2083</b>	<b>79</b>	<b>344170</b>	<b>104380</b>	<b>136623</b>	<b>1276327</b>	<b>8341</b>	<b>31558</b>	<b>607</b>

# Club focus



## London

Above: the historic London GC site at Dunstable, Beds  
 Opposite: on approach, the bowl in the background  
 Below: a Pruffing launching in the club's early days

**T**HE British Gliding Association was formed in December 1929 at a lunch held in London, and at the same lunch a group of 37 London-based enthusiasts decided to form a club in the London area. The London Gliding Club was officially inaugurated in February 1930 and the annual fee for membership was set at one guinea. One member, "Doc" Slater (in his time, editor of *The Sailplane and Glider* and *S&G*), thought it would be a good idea to go to Germany, from where epic flights were being reported, and learn how to do it and how to teach it. Then the search for a suitable site began.

Westerham and Guildford were tried out, and then a "permanent" site was found near Tring. With a road running up a dry valley, and with steep north-east and south-west slopes, it was seen as ideal. Ivinghoe Beacon became the focal point of many of the founders of British aviation, enthralled by the pioneering spirit on show (some flights lasting more than 10 seconds!). However, the National Trust, whose land it was, were not amused by so many visitors "spoiling the peaceful enjoyment of the public" – we were moved off. We quickly found our present stunning location, half a mile south of Dunstable. With its ridge facing the prevailing winds running the length of the site and beyond (providing bungee launches and sustained flight) and with its undulating field (ideal for the early training of the *ab initio*) it was perfect. It is ironic that these aspects of the site that made it so appealing then are now seen as a challenge to those who have been bought up on large flat sites.

It wasn't too long before pilots found they could climb within thermals using S-turns (to avoid being blown back over the hill) and, at height, circle in them. And then in 1939 came Geoffrey Stephenson's headline-making winch-launched soaring flight from Dunstable to Boulogne. This was a fantastic achievement, and deserves far more recognition in the world of aviation. The club was



used a prisoner of war camp during the war years, but recovered well and over the next few years became the leading club in the country for producing great cross-country pilots at world standard.

Our pilots hold many national and world records. Our tradition of being at the centre of cross-country flying has been aided by the fact that we are close to the centre of the country and not affected by sea breeze, that we are on quick-drying chalk, that we have local wave effects (and occasional wave from the Welsh mountains), and that our training can encompass sustained flight on the hill throughout the year. More recently, we have taken the lead in the training of aerobatics, and have added a club Pilatus to the fleet.

Although a large club, we are very friendly and welcome visitors at any time of year. (We don't charge reciprocal membership). We have a very beautiful clubhouse, a large fleet, and great fun.

*Adrian Hobbs*



## SOARING (OXFORD) LTD

- UK agents for all Grob aircraft including full support for single seat Astir gliders
- Suppliers of all general gliding and winching parts and accessories including everything from tyres and instruments to weak links and winch cable
- All at very competitive prices

**We will save you money!**

**SOARING (OXFORD) LTD**  
 Main Hangar, RAF Syerston  
 Newark, Nottinghamshire, NG23 5NG  
 Tel: 01636 525318 Fax: 01636 525287  
 Email: [soaring.oxford@virgin.net](mailto:soaring.oxford@virgin.net)



## At a glance

**Full membership cost:** £480 pa

### Launch type and cost:

Aerotow £21.50/2,000ft, Winch £6.20

**Club fleet:** K-13, K-21 (x5), K-23 (x3), ASW 24, Duo Discus, Pilatus B4, Super Cub, Robin (x3); also FFF motorglider

**Private gliders:** 45

**Instructors/flying members:** 85/262

**Types of lift:** ridge, wave, thermal

### Accommodation:

Rooms for course members. Professional catering

**Operates:** every day except Christmas Day

**Contact:** Val or Liz on 01582 663419  
[www.londonglidingclub.co.uk](http://www.londonglidingclub.co.uk)

**51° 52.48 N 00° 32.71 W**

**Radio frequency:** 129.90

### Important information:

Prior permission required.  
 Site is in London Luton CTR (Class D airspace).  
 Visiting pilots must be briefed  
 or call Luton Approach on 129.55

# Club news



Vintage and modern gliders enjoy the soaring over Anglia GC's base at Wattisham in East Anglia last summer

## Anglia (Wattisham)

WE had a good 2003 with plenty of good soaring and many successes. Our SkyLaunch winch was converted to LPG, bringing about a dramatic reduction in launch costs from £1/launch to 25p/launch while reducing the maintenance costs as well. Essex University students were present throughout the summer and some will solo shortly. Qwyn Thomas finished 27th in the Club Class Nationals and 8th at the Eastern Regionals and Robbo Roberts came 18th at the Easterns and 31st at the Inter-services. Our growing vintage collection includes a T-21, two Skylarks, L-Spatz 55 and a K-6; an expedition to the Vintage Rally in Poland is being planned for August 2004. Special thanks to our CFI Andy Hill, who has kept the club going and put in a terrific amount of work. The club is actively looking for new members and offers attractive membership fees, a good glider fleet, year-round flying and winch and aerotowing from one of the largest airfields in East Anglia.

Michael Powell

## Angus (Drumshade)

WE had a double first in January: Peter Downie became the first member of the affiliated Abertay University GC to go solo in Angus. Not only that, he is also the first student of our new Assistant Instructor Alex Maitland to go solo. Congratulations to both. We decided to modify the winch by cutting the lorry part off (after the latter's engine failed); it is now towed by a tractor. We thank and say goodbye to Evelyn Mands, long-standing member and club secretary for the last four years. She decided to retire as secretary and move to foreign (warmer) climes. Good luck with your new venture, Evelyn. New contact numbers and e-mail addresses are available on our website ([www.angusglidingclub.ukf.net](http://www.angusglidingclub.ukf.net)).

Wolf Rossmann

## Aquila (Hinton in the Hedges)

WE have taken advantage of poor winter weather to have our faithful Pawnee completely refurbished, our Super Cub coming to the fore in the meantime; all being well Victor Papa should be back with us looking brand new in time for summer soaring. Our ASW 19 has acquired a new trailer, making rigging and retrieves more attractive. Finally, we decided to slightly reduce our level of Red Letter Day activity to better utilise our two-seaters for increasing numbers of *ab initios*.

Robert Cronk

## Bannerdown (Keevil)

AT our AGM we celebrated another successful and safe year. The club is financially very sound and boasts flying and ground equipment to be proud of. The Discus looks good after re-gelling in Poland, while the LS8 has enabled Al Stacey to learn the whereabouts of every stick and stone on our local ridge in recent northerlies. Awards were made to Taz Hocking, for most progress, and to Simon Foster for overall merit in maintaining club aircraft. The CFI's Trophy went to Keith McPhee in recognition of a range of club activities. Jon Arnold's award was for competition successes, and our ever-present Mike Knell was declared Hog of the Year. Eddie Cole's skills in keeping vexatious electrics in order earned him the John Burn Trophy, and the Keevil (Best flight) Cup went to Megan Montgomery, for a much sought after five hours. John Dawson was congratulated on his 500km, after a lengthy absence from flying.

Derek Findlay

Please send news to [editor@sailplaneandgliding.co.uk](mailto:editor@sailplaneandgliding.co.uk) or Helen Evans, 7 Ollney Road, Minchinhampton, Stroud GL6 9BX to arrive by **April 13** for the June-July issue (June 15 for the August-September issue)

## Bath, Wilts & N Dorset (The Park)

WE are very fortunate in having among our members so many with the expertise and time to keep our aircraft flying throughout the year. Some have been lucky enough to do their work in our newly-heated M3 workshop! The tug re-covering project is almost finished and the Pawnee is now resplendent in new fabric and paint and should be flying by the end of February thanks to Dick Yerburch, who has almost lived in the workshop since November. Our Venture is now flying again thanks to Ed Gunner and his team after its overhaul and re-cover. Alastair MacGregor and Mark Hawkins are organising a club expedition to Sutton Bank this spring.

## RAF GSA Bicester (RAF Bicester)

LATEST news on closure is that RAF GSA Centre and JSAT(G) operations are moving to RAF Halton to be operational by June 7, 2004. New club formed and hopes to lease land from MoD to continue gliding at the site – [www.windrushers.org.uk/](http://www.windrushers.org.uk/) It's been a long and wet winter but the diehards have flown at every opportunity; many thanks to all those who have put in the effort to fly/instruct, etc. The maintenance is all but completed and one of our Pawnees (G-IY) is now sporting a shiny new colour scheme. The Oxford Uni is planning an exped to The Mynd and is hoping for some good soarable conditions so that new members can sample ridge and wave flying. A big party is planned, provisionally for May 22, to mark the end of RAF GSA gliding at Bicester. All welcome, especially past and present members of Bicester/RAF GSA. Please contact Nick Aram at [nicktheparty@rafgsa.org](mailto:nicktheparty@rafgsa.org) for info and to register interest. Inter-service regionals at RAF Cosford this year (July 31-August 8) – applications at [www.rafgsa.org](http://www.rafgsa.org).

Nick Aram

## A KEEN EDGE



Is what we can offer when it comes to aviation insurance. That's because we give you the same prompt and personal attention, whether you are taking out a policy or making a claim!

 **hill** aviation  
insurance  
services ltd

MEMBER  
  
General Insurance  
STANDARDS COUNCIL

Phone, fax or write to: **Stephen Hill**

Phone: 01765 690777 Fax: 01765 690544

Unit 1A, Sycamore Business Park, Copt Hewick, Ripon, North Yorkshire, HG4 5DF.

# Club news



Les Fletcher (in glider) and Keith Brackstone at Bidford

paint the rails, winches, wing dollies and so on to meet the completion date. Many thanks for all their efforts. Each owner can remove and replace their glider without assistance if required. We have even managed to squeeze the LAK 12 into the main hangar for the winter. Bookings for wave weeks are coming in and we will host an expedition from Hus Bos. Congratulations to Ian Surley and Richard Abercrombie on completing Bronze. **Andy Henderson**

## Bowland Forest (Chipping)

WE are enjoying some flying despite variable weather. Bob Pettifer is organising Saturday evening lectures for pilots preparing for Bronze. Our third K-13 is being painted ready to come on line in spring. We are considering implementing a 'Management Plan for Conservation' in association with the RSPB, whereby the airfield area could be enhanced to create good areas for wildlife, especially to benefit the already present breeding waders such as lapwings and curlews. This plan may bring a small annual income, but would also forge positive links with the local community. For information about the club, see [bfgc.co.uk](http://bfgc.co.uk).

**Eileen Littler**

## Bristol & Gloucestershire (Nympsfield)

THERE has been increased interest in a proposed six-aircraft hangar. Plans have been received from New Zealand and costs are being generated. Roger Targett has agreed to pay for another planned new hangar for Sailplane Services. A useful meeting was held with Development Officer Roger Coope about our grant application to rebuild our clubhouse. Subs are to rise by 3.25% and aerotow prices are being reviewed. Options for mobile signs to the club and improvements to the entrance are being explored. Payments by debit card are to be introduced. Chairman Steve Parker and secretary Bob Williamson were re-elected at the AGM. Peter Bray continues to act as treasurer. Our summer instructor, Gavin Wrigley, from Australia, arrives just after Easter to replace Danny Goldsworthy, who has left, with our thanks. Student James Fordham did his five hours in the LS4 and landed just before the snow started. Members are being urged to lock up if they are the last to leave. There's still time to book to try for some of the excellent prizes in the Rolex Western Regionals, August 7-15.

**Bernard Smyth**

## Burn (Burn)

FEBRUARY 5 brought our first hour in thermals this year, the wave pundits had already achieved long flights but we don't count these. We are very pleased we are on hard runways given all the wet weather. The club Panto was a sell out ("Oh yes it was") when pilots were reminded of those naughty moments they thought everyone had forgotten. Our day in court is booked in our attempt to stay at Burn. Our new landlord, a Government agency, has at least increased the level of negotiation now that a court application has been made. It's quite annoying when we consider as club members and taxpayers that we are having to pay the lawyers on both sides of this dispute.

**John Stirk**

## Cairngorm (Feshiebridge)

WE haven't been flying at Feshie because we've returned the runway (it looks so good we're thinking of taking up golf!). Carol Osborne has made the most of Highland GC's kind hospitality and has passed her Bronze there. We're looking forward to Mayfest from May 1-16 - contact Chris Fiorentini on 01540 673231 for details. We know that it's a long way for people to come, but you'll be assured of a very warm welcome.

**Ruth Binks**

## Cambridge (Gransden Lodge)

BY the time you read this, our brand new K-21 should be flying. Also on site is a Faulkes Flying Foundation



The new 22-glider hangar at Borders GC, Milfield

## ➤ Bidford (Bidford)

CONGRATULATIONS to Les Fletcher on being sent solo by Keith Brackstone in the Puchacz and to Alan Broadbridge, who has achieved his Diamond Badge. John Pride has his NPPL conversion. We have had a blitz over the winter, cleaning and hard-waxing the club gliders, led by CFI Frank Jaynes: they look and fly like new! Thank you to members who gave up their time to help. A series of Bronze lectures has been run by Gordon Burkert for up-and-coming post-solo pilots. We say farewell to our full-time office manager Alan Peever, who has decided to 'officially' retire, after a number of years' service keeping the club running smoothly. His organisational skills and cheerful manner will be greatly missed. We will open seven days a week from the end of March and our Regionals is from June 12-20.

**James Ward**

## Black Mountains (Talgarth)

THANKS to the sterling efforts of Steve Blackman, we now have a warm and cosy clubhouse - a long way from the previous old, wet, leaky caravan! Despite the very wet January, the field has held up. Keith Richards is throwing all his effort into his new business at Talgarth. On site most weekdays, he will provide useful midweek backup for launching and instructing. Don Puttock will be employed full time from Easter as manager, instructor and tug pilot. By the end of December, we had clocked up nearly 2500 launches during 2003, the best for several years, and look forward to another cracking year in 2004. We are always happy to see expeditions from other clubs (pre-booking essential). The Burns Supper was the usual success with members tasting haggis and fine malt whiskies.

**Robbie Robertson**

## Booker (Wycombe Air Park)

THE first thermals were soared in late January and we've had some decent north-westerlies on our home, or Chinnor, ridge. Most of the activity at this time of the year is in the planning stage. There are expeditions to Shobdon and Serres in the spring, and possibly Jaca in September; the dinner dance and AGM are imminent; two Robin tugs are away for extensive refurbishment in France. That should give us five club tugs as well as a private Robin for the season. The refurbishment of our second K-18 (Eighteen) is also coming along well. A substantial number of members are due for instructor courses in the very near future. Our "no entry fee" regionals is back again for June - all welcome.

**Roger Neal**

## Borders (Milfield)

SEVERAL wave flights in excess of 12,000ft got the New Year off to a great start. The new 22-glider hangar was officially completed at the end of December and we hope to hold the official opening as part of the BGA National Gliding Week. All owners have contributed significant amounts of time to manufacture, install and

Rotax Falke. The CFI will shortly be issuing detailed schematics to show how all these aircraft will fit in the hangar. Work continues on various improvements: we have much more car parking space, a concrete ramp to taxi the tugs up for refuelling and a tremendous amount of unsightly junk has gone. We are also well on the way to having waterballast tanks in the trailer parks. Those who volunteered to help, and particularly the planners and organisers, well done. We have benefited again this year from winter refresher courses as a more productive alternative to annual check flights. Several new winch drivers are being trained, which should relieve roster pressure. Gransden is hosting an inter-club league heat at the end of May and our Regionals is August 7-15.

**Gavin Deane**

## Chilterns (RAF Halton)

GOOD news for solo UCL pilots - the UCL GC have (thanks to a grant from the Union) bought the Chilterns K-6CR - and no longer have to vie with *ab initio* for the K-21. Early February saw the first cross-counties of the year - albeit along the Chilterns scarp slope to the south-west. Some useful streeeting allowed one ASW 27 pilot to cover over 120km one Sunday afternoon, the rest having to content themselves with 70-80km out and returns purely using the ridge. In late January we used the annual Burns Night to well and truly christen our temporary bar/clubhouse; thanks mainly to Moira for organising with support from Derek... We look forward to early June and having the use of our hangar again - shared with our brethren from Bicester.

**Andy Hyslop**

## Cleavelands (RAF Dishforth)

WE had our usual crop of visitors over our Christmas Wave Camp, some old and some new. Most of them were rewarded with a flight or two in the wave and even on days it didn't wave we had plenty of pleasant flying weather. Christmas Day itself wasn't flyable so we had Christmas dinner early. This was a traditional affair expertly prepared by Andi Causer and a few little helpers. Everybody enjoyed the occasion and a big thanks goes to Andi for that. Our current crop of youngsters have all converted to the Discus but we must temporarily say goodbye, and good luck, to one of them, Michael Desmond, who has joined the Army. Karl Dagger went solo just before Christmas.

**JM**

## Cornish (Perranporth)

WE have some of the loveliest scenery in the country and a friendly club. Mary Meagher, a gliding granny to be reckoned with, spoke at our annual dinner-dance. It was a good do. Trophies allocated for services to the club are especially notable, so congratulations to John Dale and his field maintenance crew, and to Brian Farrow for his tireless efforts in maintaining the Super Falke. The Falke has had a complete strip-down and

overhaul, thanks to Brian, Dave Puttock and Pete Arthur, who was in overall charge. A first class job! Thanks to John Shaw, our CFI (again), who has (again) outdone his agreed stint in keeping the club going, along with his wife Shaunne. And also to Nigel Climpson, our newest Assistant Instructor, who has been thrown in at the deep end and stayed afloat remarkably well, with good humour.

Dean Penny

### Cotswold (Aston Down)

THE club AGM elected Tim Barnes as chairman. Our thanks go to Andrew Flewelling, who stood down from the role after three years. The club will celebrate its 40th anniversary on July 3, which coincides with the last weekend of Competition Enterprise, so get your entries in and enjoy the party. More details later ... watch the website. Our recent dinner dance was a great success; cup-winners were: (Pre-Silver) Gerald Birt, (over 50s) Simon Buckley, (Junior) Alistair Harrison, (height gain) Jane Randle, (best 100km triangle) Rob Corbin, (cross-country) Doug Gardner, (two-seater) Gary Fryer and Mike Oliver and best competition placing was the Duo Discus syndicate. Our new Skylaunch arrives in March. Gap-year student Sally Longstaff has used the power of her pen to secure a Skylark 2.

Frank Birlison

### Cranwell (RAF Cranwell)

AS with most clubs, winter has seen a lot of glider maintenance and talk of deeds past. The club has four new BIs in Chris Franklin, Tim Davies, Peter Kingwill and Gareth Baker. We have managed to get through a number of annual checks for solo pilots and the CFI has pointed out the many simple but essential routines on the ground to preserve our kit and our safety.

Paul Skiera

### Dartmoor Gliding Society (Brentor)

WEATHER, holidays, festivities, and in some cases I suspect SAD have restricted flying but there have been enough good days for the enthusiasts to keep current. Work has continued as usual on the site and equipment during this quieter period. Chris Matten, our fundraiser, reports that our vouchers are selling well and he is hoping to increase income and recruitment by more flying with visiting evening groups. It is hoped also to encourage participation by a local special school. Plans are being laid for an exciting 21st anniversary celebration of the club's first flight on July 24, 1983. Our Field Treasurer is excited by the installation of his new software. There is a rumour that it will have the capacity to freeze the personal bank accounts and ground the gliders of members going into the red with the club.

Phil Brett

### Deeside (Aboyne)

IN January we had a number of good wave days and cross-country flights, one in excess of 200km! Bronze



Hare and tortoise at **Dartmoor**: Gavin Short (right) got Silver in just over a year; Martin Cropper after 32 years



**Dorset GC** celebrated the Centenary of Flight by flying on a sunny December 17 with blue skies (Colin Weyman)

lectures have continued throughout the winter, thanks to Graham Holloway and this should result in a crop of new Bronze pilots for the spring. Congratulations to Steve Thompson on achieving his Full rating. The club celebrates its 40th anniversary this year – details in the next issue. We can offer courses to suit all levels of ability, contact Roy Dalling on 013398 85339.

Sue Heard

### Derby & Lancs (Camphill)

CONGRATULATIONS to Jeff Daniel on his first solo, and to trophy winners: Mike Armstrong, Nigel Howes, John Klunder, Andrew Fletcher, Roger Fielding, Bob Makin, Tony Smurthwaite, and Peter Gray. On one of the few good days this wet winter, CFI Mike Armstrong got his ASW 20 up to FL140, his last flight in 271 before it migrated south. We had another good day in early February and he took our DG-500 to FL 160, both flights opening our wave box with Manchester ATC's cooperation. The AGM saw a few changes to the committee, but none to subs. We said goodbye to Viv Chadwick, local farmer's wife, who kept Camphill fit for human habitation for over 25 years. Thank you Viv, and good luck. By the time this appears Miranda Cobb should be back to cater for our culinary needs.

Dave Salmon

### Devon & Somerset (North Hill)

THE part of the field that was levelled and re-seeded is progressing well and should become usable again once it has been rolled. Meanwhile winter gliding has proceeded with excellent days in the mild weather. Gliders with engines seem to be proliferating with the addition of a Ventus Turbo and ASW 26E in surprising quarters. Meanwhile those of us not so blessed finish our domestic tasks to amass Brownie points and await the spring thermals with eager anticipation.

Phil Morrison

### Denbigh (Lleweni Parc)

OUR Super Blanik is flying at last – a big improvement on our old, but still much-loved K-7. We hope to aerotow this season. Over the past six months flights in the Falke have proved that wave is often present on just about all points of the compass. We are to start a young pilots scheme in conjunction with Denbighshire County Council's sports development team, offering scholarships to the two best candidates after selection tests. We will start recruiting soon from local schools, colleges and youth organisations. We believe it is possible to get good media coverage and improve the sport's profile. Work goes on with maintenance and improvements, we are as always indebted to the usual suspects, Tony and Jane, just two of them, are planning a tour of UK gliding clubs this summer. We are still looking for instructors (weekends and midweek). If you think you help please contact us on 01745 813774 or via email at [office@denbighglidingclub.co.uk](mailto:office@denbighglidingclub.co.uk)

Ian Walton

### Dorset (Eyes Field)

NOVEMBER, December and January were fairly kind to us and we managed to keep flying for most of the time. Our tug is still going well, with a lot of us opting for 3,000ft aerotows during winter. We had a flying day on December 17, instigated by Kevin Westwood, to celebrate the Wright Centenary. As well the entire club fleet, nearly all our private gliders were rigged, with most pilots taking high tows on a day with sunshine and clear blue skies. Our club fleet consists of two K-13s, two K-8s, our ageing Tost winch, which has recently had much refurbishment (thanks, guys, you know who you are), and our Beagle Husky 180 tug. Oops, nearly forgot, our two stalwart dumper retrieve vehicles. The dates for our task week and weekends are: May 28-31 inc; July 24-August 1 inc; and August 27-30 inc. We welcome all visitors. For a map, directions, and application form, see: [www.dorsetglidingclub.freeserve.co.uk](http://www.dorsetglidingclub.freeserve.co.uk). If any "old" club members from Tarrant Rushton or Old Sarum would like to get in touch, my email is: [colteresa.weyman@virgin.net](mailto:colteresa.weyman@virgin.net)

Colin Weyman

### Dukeries (Gamston)

OUR clubroom, which was suffering from every kind of rot imaginable, has been demolished and burned and a new clubroom purchased. We have a new Portakabin, ideal if we ever have to relocate because of Finningley restrictions. Our fleet is being updated in line with our 2004 objective of pushing up cross-country kilometres this year. We hope to be getting our Janus back (after its crash last year). We hope to graft our B wings on to an ex-Bicester Janus C fuselage. Perhaps the first Janus BC in the country. It is to be fitted with LNAV, as is our Vega. Work parties are working on the grounds, trailer park, etc, so that we present a good image to visitors. We still have the cheapest fixed-price-to-solo (£300).

Mike Terry

### Essex & Suffolk (Wormingford)

WE have had flights in recent weeks in excess of 40 minutes! I don't usually get to write double digits in the flight log until at least April. We have added a rather nice Pegase to the fleet. The usual culprits have been diligently involved in a complete strip-down of one of our Tost winches. I have to correct a typo that crept into the last club news. Viv Halley did 500km not 800 as reported (sorry, Viv); still very, very impressive. A resolo to report: Graham Wright, after some 30 years from his first with the ATC. Well done. A new initiative at ESGC is seven-day flying for July and August – trial lessons as well as one- and five-day courses. We are taking bookings now, so call John Bone on 01206 241701.

Steve Jones

### Essex (North Weald/Ridgewell)

CONGRATULATIONS to Peter Berridge on Gold height at Aboyne, Darren Smith on solo and Kevin Smith on his R/T licence. The restriction on part of our Ridgewell

# Club news

Y site has been lifted by the authorities so we are back to the full 28-day use of the 22 acres in question. Even better, we have negotiated with a local farmer to extend the site to part of the old east-west runway, making our operation much more flexible. Many thanks to all those concerned for their hard work. David Jones is working hard on a second winch. We have been very pleased to welcome into the club some youngsters. By the time you read this we will have returned to our Ridgewell site for weekend flying whilst continuing at North Weald on Wednesdays.

Peter Perry

## Fenland (RAF Marham)

AN official vote of thanks to AJ for all her hard work as she is now standing down as Stats person – all claims and stuff now go to John DD. A note from Pete Harris to all from the last committee meeting: let's have a few more people out on Saturdays please; spread the load. Congrats to Olly Chubbock, who has graduated from his RAF training at Cosford and starts a new life at Wattisham, and takes on the duty of Parachute Member. Welcome back to Dave Wren, who is on the airfield again after a short lay-up.

Graham French

## Highland (Easterton)

WE are having a bit of a mixed bag of flying weather this winter: weekends with gliders up in good wave and some good ridge days but we also had some very wet weekends. These latter have been put to good use and great progress has been made on our new clubhouse. We now have two new tug pilots, Jules Collis and Mike Cryle. Who knows, this may be the year I get my Silver distance and will I let you know it!

Roy Scothern

## Imperial College (Lasham)

AFTER the thrill of ridge and wave soaring at Long Mynd over the New Year with other juniors, circuit bashing at Lasham in grotty weather feels a little depressing. Despite this, members are still appearing in numbers; several have developed an unhealthy interest in aerobatics. Congratulations to Jamie Denton on his Basic Instructor rating. Recent activities include trailer scrubbing to raise money for Imperial College RAG, and our annual dinner. We expect a busy Easter Course as several members are either close to first solo or completing Bronze. Following club trips abroad in previous years, planning is well under way for this summer's expedition to Ontur, Spain.

Luke Cooper-Berry

## Kent (Challock)

AT our well-attended AGM Stefan Bort, our chairman, reported a good level of activity in the previous year, with 29 new members. A number of social activities are planned, starting off with our making chumps of ourselves at a quiz night. A big send-off is also planned for instructor Chris Luton, who is moving to Nottingham in a new job and Hus Bos in his free time. A move to hold more flying evenings is being made, and our open weekend will coincide with National Gliding Week.

Caroline Whitbread

## Kestrel (RAF Odiham)

THANKS to Sylvia Scott and helpers for organising our well-attended post-Christmas party. At our recent AGM the following presentations were made: Chairman's award to Barry Sealey for his work on the K-13, CFI award to Bernd Vermeulen, who got his full cat and MGIR, Alison Farrel memorial trophy to Shane Naish for best improver, Cross-country award to Marc Morley and Junior award to Rob Armstrong for retrieve driving endurance. We should all be wiser by now, having completed our winter lecture programme.

Simon Boyden

## Lasham Gliding Society (Lasham)

A DG-1000 has been ordered as an addition to our glider fleet. Our new Falke G-CCHX flies beautifully. The Wright Centenary was celebrated by a barbecue in December and by fireworks. The staff and committee members in fancy dress with the theme of Those Magnificent Men in Their Flying Machines did a great job of feeding members at the Christmas party, courtesy of Mike Evans and the canteen staff. A full programme of general interest lectures and Bronze lectures is in progress. A new flight briefing room has been installed in the Brown Elephant, complete with computer set-up for internet net access and NPPL studies. We thank Ray Partridge, who is retiring after a long and distinguished period as club treasurer. Gary Pullen flew his ex-Crown Service GC K-13 for more than 200 hours in 2003, gaining all three Silver legs and collecting the Dunstable Plate in the process. During the autumn expedition to Aboyne, Gold heights were achieved by Paul Barnett, Shaun Lapworth, Heindrik Stheetman, Martin Conboy and Chris Mann. Gareth Bird, Dave Bowtell and Nicky Marchant have their NPPLs.

Tony Segal

## Lincolnshire (Strubby)

THE club is now 25 years old. We celebrated with a party at the Woodthorpe Inn, our watering hole, well



Bradley Parker of Mendip GC soloed as soon after his 16th birthday as conditions allowed (Keith Simmons)

organised by our treasurer Phil Niner and enjoyed by a large gathering of members past and present and their guests. We have had a successful winter with kind weather. The Blanik has been sold and is to return to its native Eastern Europe. Plans are under way for the coming season with a first flying week commencing May 3. A challenge to Trent Valley: we still have the rosebowl cluttering up the cupboard so come over and get it, or we will really take the Mick and bring it back.

Dick Skerry

## London (Dunstable)

OVER the winter our hill has been working well, and there has been a good turnout of pilots eager to stay current. In February cadet Matt Robain used it to gain his five hours. We have many new solo pilots, our annual Bronze lectures are well attended, and our trips to Shobdon and Cerdanya are fully booked, as is our Regionals. We have replaced a Super Cub with another Robin DR400, with a three-bladed constant-speed prop. Steve Jarvis, Mike Woollard and Alex Yeates gave a hugely entertaining talk on aerobatics. The graphics were breathtaking, and the coincidental visit by some BAeA judges was a delight, as they started giving marks out of 10 for each animation! This talk generated even more enthusiasm and brought a twinkle to our treasurer's eyes the next morning when he saw the queue of pilots waiting to climb into the g-meter-carrying K-21s.

AH

FASTENERS, HANDLES & CASE FITTINGS - AVAILABLE IN STAINLESS OR ZINC PLATED STEEL DIRECT FROM U.K. MANUFACTURER



**protex.com**  
PROTEX FASTENERS LTD, Redditch, B98 8PA, U.K.

Tel: 01527 63231 Fax: 01527 66770

e-mail: sales@protex.com



Please call us for a FREE catalogue

## Mendip (Halesland)

IN mid-December the tug proved its worth by enabling members to reach wave to 12,000ft over Weston-super-Mare. The more impeccable amongst us took winch launches and flew circuits! Bradley Parker's 16th birthday was in December, which meant that the chances of "first solo" (conditions were remote (bear this in mind when planning offspring)! It was mid-January before conditions were favourable. Bradley produced a textbook circuit with a greaser landing. Mat James, another of our 16-year-old solo pilots, has converted to his Skylark 4 and has already outsoared the CFI!

Keith Simmons

## Midland (The Long Mynd)

THE rise of young pilots continues. Sarah Platt and Ian MacArthur have been chosen for Ted Lysakowski Trust awards and John will go to Australia to spend two weeks with George Lee before training in Spain with the UK juniors. Oldies can't complain. Three of them have had facelifts in Poland (gelcoats and instruments) whilst the most venerable, K-21 ELE, has been given the nod from Father Germany to fly for another 6,000hrs. There's a Tarmac apron outside the hangar. Smokers can now be found by the windsock, which is a bit hard but was an overwhelming members' decision. And speaking of wind, if you want guaranteed bungy days, join our Dutch visitors in April. They haven't missed yet. The bunkhouse has been refurbished by Mike Whitton and Dave Crowson. Courses are booking well.

Roland Bailey

## Needwood Forest (Cross Hayes)

MOST of our club fleet has seen action recently, except the new K-13, being fettled by Alan Roberts. Thanks go to him for the continued effort he puts into maintaining our aircraft. Thanks, too, to Adriana and Peter Kent for redecorating our clubroom. Despite flying getting in the way we are managing to do some more serious stuff in the form of club development workshops and various social events, including a karting evening won by Justin Strachan. Members have already organised a trip to Ontur. For our news see [www.gogliding.co.uk](http://www.gogliding.co.uk).

Paul Machacek

## Norfolk (Tibeham)

ON January 10 we were treated to Matt Cook's account of the Junior World Championships, a very entertaining and enlightening presentation, supported by photos and maggot racing. "NGC Racing" has been very well attended and supported. Thanks to all the individuals who are supporting it. Gavin Searle has soloed, Tom

Smith has his Silver and James Baker his 100km Diploma. CFI Dave Munro is instigating a new intensive *ab initio* training scheme and Dave and Bob Grieve now have CAA motorglider instructor ratings. We have done a considerable amount of flying this winter and managed more launches on December 17 than on the longest day! The Christmas Party was an unrivalled success, hosted by Woody. Bonnie Wade has, after 10 years, produced her final *Tibeham Thermaller*. This excellent newsletter has entertained and informed members and appeared at many other clubs. We thank Bonnie for her literary and editorial enrichment of our gliding culture. Josie Briggs has taken over with a monthly email newsletter called *Low and Desperate*.

Ray Hart

## Northumbria (Currock Hill)

ADVERSE winds and a waterlogged airfield have restricted flying of late. However, there has been a limited amount of weak wave occasionally. Alan Adams has become a BI. Roy Mitchison has gained a Diamond height in a Discus from Minden, Nevada. The old workshop has been demolished and the new one is in use. The second phase of the new airspace restrictions will not be enforced until August 2004. Having disinterested the club newsletter, I have handed on the editorial mantle to the brothers Craig and Chris Storey, who have produced their first excellent edition. They have resurrected the title "Thermal". This might be in homage to heat-retaining underwear (necessary), rather than to atmospheric convection (rare).

Len Dent

## Nottingham University (RAF Syerston)

AFTER a very successful Freshers' Fayre, the club continues to thrive with a membership of over 100. We have some very keen new members who are making fast progress. The annual expedition to Portmoak will be at Easter and we have organised a trip to Ontur in late June. There have been a number of very successful socials, notably the Murder Mystery Party. We are also in negotiations for possible sponsorship.

Rachel Hine

## Oxford (RAF Weston on the Green)

LIKE a 'carbuncle on the face of an old friend', the OGC hangar has now got a spiffing new extension, in which all manner of stuff can be, er, stuffed. Apart from that, the club surges on with maintenance, Cs of A and general fettling in anticipation of a stunning soaring season. As if.

Steve McCurdy

## Peterborough & Spalding (Crowland)

MEMBERS are shocked and saddened by the tragic death on February 1 of one of our senior members. Robert (Bob) Sharman was a very active member of our club, a working member in every sense of the word. A tug pilot, gliding and motorgliding instructor, Bob was always eager to give help, practical and knowledgeable. He had an incredible enthusiasm for life, which never seemed to diminish. Once in a while a person comes along whose journey through life is no routine traverse. Bob Sharman was such a man and we have all benefited through knowing him. He will be greatly missed and our thoughts are with his wife, Sylvia, daughter, Annie, son in law, Martin, who are all club members, and the rest of the family (see *obituaries*, p61).

Joan Pybus

## Portsmouth Naval (Lee on Solent)

THERE has been some unexpected local thermal soaring but, less surprisingly, the rain has made parts of the airfield resemble Lee in the Solent rather than on it. As a result we are temporarily confined to the paved surfaces and have become an aerotow only club. Two days before Christmas a small group of members gave up a day of Christmas shopping to open the club so that Fran



Fran Aitken of Portsmouth Naval is congratulated by instructor Tony World after soloing on her 16th birthday

Aitken could solo on her 16th birthday. Fortunately the weather cooperated for just long enough. Our very successful annual dinner and dance was at HMS Collingwood, where our new chairman, Andy Edney, took over from Peter Waugh. We welcome Andy to his new role and give our thanks to Peter for all his hard work over the last five years.

Steve Morgan

## Rattlesden (Rattlesden)

DURING the winter and spring CFI Andy Howells has organised many talks: a cross-country discussion led by Andy; a meteorology talk from Weatherjack, and a BGA safety presentation from Kevin Moloney. Some more experienced members plan to hold talks: Grenville Croll on speed to fly; Mark Taylor on task-setting and Tony Bartlett on Notams. The Bird Brain quiz was back again with quiz master Brian Partridge. Congratulations to the winning team 'Rattlesden Old Farts' plus Gren. The K-21 is back from Poland, where it was re-gelled and now looks beautiful, thanks to drivers Martin, Steve and Geoff. Belated congratulations to Helen Varley and Paul O'Leary for getting their Cross-country Endorsement and apologies to anyone whose achievements I have inadvertently missed. Finally a few dates for your diary: task weeks are May 24-28 and August 16-20.

Cathy Page

# Omarama New Zealand Alpine Soaring The Gliding Specialists

We offer the best support and training at all levels and a great friendly atmosphere

- Wave flying • Casual flying
- Courses • Badge flying
- Glider hire • Accommodation

[alpsoar@extra.co.nz](mailto:alpsoar@extra.co.nz)  
[www.soaring.co.nz](http://www.soaring.co.nz)

## The Motor Glider Club

offer:

### NPPL Courses RT Course & Testing Centre

Rates	Dual	Hire
Motor Glider	£55ph	£45ph
C150/2	from £70ph	

NPPL Courses from £750

HINTON IN THE HEDGES AIRFIELD

Tel: 01295 812775

In Association with



Tel. 01865 370814

# Club news

## Scottish (Portmoak)

WE were all surprised to find that one of our members had had a sex change – apparently this comes free with a Silver Badge. When he claimed it, he was good old John Munro – but when it was published in the last S&G (p62, no 11334), she was Joan Munro. John would like me to ask people to stop winking at him or offering him women's clothes. On a more serious note, the foundations have gone down for the club hangar and we expect the steelwork in early April. We plan to celebrate our 70th anniversary and the opening of our new hangar on July 10-11, and would like as many members as possible to join us. If you have ever been a member, please consider visiting that weekend. For more, please see [www.scottishglidingcentre.co.uk/](http://www.scottishglidingcentre.co.uk/) or call 01592 840543.

Ian Easson

## Shalbourne Soaring Society (Rivar Hill)

PRIZE for the longest flight on the shortest day went to Geoff Nicholls with 49 minutes in his LS3. Seven other flights in the region of half an hour or more were also logged. Any post-Christmas blues were banished at our Annual Dinner, organised by Clive Harder. Dave Morrow and Liz Sparrow provided the cabaret act. Ayala Liran received the Dave Maleham Memorial trophy for the most significant progress; Instructor of the Year went to Jerry Pack; John Day was the Club Member of the Year; whilst the Retired (but very active) Member of the Year was Trevor Greenwood. Task Week winners were Carol Pike and John Day; with Martin Hoskins winning the Club Ladder. Martin picked up another 'award', when he and Jim Gavin were deemed to be worthy winners of the Vanish Trophy for Sartorial Elegance, due to their outstanding (?) winter headgear. Matt Carter was the overwhelming choice for the You Landed Where? trophy; and Liz Sparrow collected the Get a Move On award. Finally, the K-13 made a welcome return, having spent a few months being repaired following an unfortunate tussle with a hedge. A grant from Newbury Town Council allowed us to have a hand rudder fitted during the repair work, and this has already been used.

Liz Seaman

## Shenington (Shenington)

WE would like to share with you excerpts from a splendid bit of publicity from the back page of the weekly *Banbury Guardian*. Together with photos of the winch, instructor Dave Heath and a K-13, reporter Euan McCall, who had just experienced a Shenington Winch Launch, described it as follows: "The launch offers a dramatic entry into the sky, by pulling the glider on a chain, propelling it almost vertically into the stratosphere..." Perhaps we should ask the CAA for an extension of vertical airspace? Farmer Gibbs, who owns the airfield, has graciously eliminated the triangle of fence in the centre that has proved so hazardous to visiting Duo Discuses. A small mountain of perimeter rocks has been removed by our winch driver, Kathy Barnes, and the useful landing area greatly expanded. We have acquired John Hampson's Twin Astir, complete with rolling stock and T-hangar. A club trip to Ontur in Spain will go ahead in April. Dave Perkins and Roger Hurley are now Full Cats. Phil Brennan will be stepping down as CFI, to be replaced by Mark Stevens. Congratulations to Janet Mare on becoming a Basic Instructor.

Mary Meagher

## Shropshire Soaring Group (Sleep)

THE longest flight by a member this winter has to be the 500km by Chris and Jo Fox in a Duo – in Australia. Back at Sleep the Twin Astir syndicate has started a training programme with Al Gilson. Visitors from other clubs took advantage of the hard runways over the winter. We had an excellent evening saying a formal goodbye to Charles and Ella Webb. At the same time we

said what we hope is not a final farewell to Alan Levi, our tugmaster for many years. He has just retired from airline flying and has moved to Bangkok. Apart from making plans to visit Jaca in the summer, Dave Triplett is working on a new website to replace our old Welshwave site. In time we hope to post the wave prospects on the site in time to allow visitors to join us for the weekend.

Keith Field

## South London (Kenley)

A DAMP start to the year means that routine maintenance is well ahead and we are now looking forward to a busy season, even if additional Air Cadet activities will deprive us of a few days this year. (It is, after all, their airfield.) We are busy upgrading and standardising our winches. We shall be holding our annual Charity Day on May 3. On weeks when we are closed for Air Cadet training, foreign excursions are planned to Jaca at Easter and to Le Blanc in the summer. We shall organise a summer excursion or two in this country to permit some of our members to secure some of those goals that are quite difficult to achieve in our limited airspace. And just to remind you, although we call ourselves the South London Gliding Centre ([www.southlondongliding.co.uk](http://www.southlondongliding.co.uk)) we are still Surrey Hills Gliding Club!

Peter Bolton

## Southdown (Parham)

THE SF-25 Motor Falke continues to prove invaluable, but we are still looking for an advanced two-seater for cross-country flying. We now have a squad of SLMG pilots and it is hoped that NPPL training will eventually be offered. Visitors soaring the ridge this spring may like to take advantage of Dick Dixon's excellent guide to *Soaring the Southdowns*, available from the office. Chris Backwell has taken over as CFI from Steve Way. We have been fortunate in having Steve's firm leadership of the instructor community and offer our full support to Chris. The Christmas party brought its usual warm glow and the outstanding award went to Craig Lowrie. His flight of 760km won him the Sky Sailing trophy and was the longest flight ever made from Parham. One of the team responsible for basic training, after our move from Firlie Beacon in 1973, was Ray Brigden. It is with sadness therefore, that we report his recent death. Many pilots and instructors who learned to fly during the 1970s will remember him with great affection.

Peter J Holloway

## Stratford on Avon (Snitterfield)

OUR beloved K-21 has returned from Poland having been totally refurbished with a new gelcoat, looking resplendent. A team of hardy volunteers has been working on the instruments, radio and interior ready for the roll-out ceremony. We have maintained flying most days this winter, including when there was a dressing of snow, a new experience for many new members. Our new Safety Officer, Rob Martin, is in place, having brought a wealth of experience, not necessarily gliding, from flying with Kestrel from Odiham. We wish you well, Rob. My apologies for having missed out recording Andy Balkwill's award at the AGM of the cup for the most progress during the past year with his first 300km and Assistant Instructor rating. We understand that a K-6 is on site with BUGC involvement – more later.

Harry Williams

## The Soaring Centre (Hus Bos)

IN 2003, members did 58 flights of over 300km or more and 13 flights of 500km or more, with the longest overall flight being 610km. Dave Booth won the club open ladder, and Malcolm Guard won the club weekend ladder. Well done to everyone. The single-seat hangar door has been rebuilt. The clubhouse, bunkrooms and office have all been redecorated and the function room

soundproofed. Thanks to all who helped. A "new members liaison group" (Derek Abbey, Richard Large and Chris Lee) will help them to find their feet, and provide advice and guidance to existing members if required. Our club Puchacz, FWT, has been refurbished and re-lived in Poland. A full programme of social events is being organised by the Hus Bos "S" team, starting with the "Launch 2004" party on April 10. The BGA starts operations here on April 3. Our weekday flying courses will start on April 13. The club AGM will be held on April 24. The first leg of this year's inter-club league will be at Hus Bos on May 1-3. Claude Woodhouse celebrated 60 years of flying with an appearance on Central TV. It is with sadness that we report that Peter Avery, a life member of the club, died in February.

Siobhan Crabb

## Trent Valley (Kirton in Lindsey)

THE weather has started to improve so we are hoping to soar once again. Some lucky members were able to enjoy the winter wave over Kirton, especially on Christmas Eve. Alan Spencer and Kah Chong have soloed and John Margrave has passed his Bronze – well done. Sadly, Kah has to leave us due to job relocation; we're sure you'll be welcomed at Pocklington. Following the success of our Christmas Dinner we look forward to our annual dinner and prizegiving in March. Members are starting to get excited about the forthcoming visit, in April, of the Fox aerobatic glider.

Janet Nicholson

## Ulster (Bellarena)

SANTA Claus came to the club a few days before Christmas in the form of grant aid approval under a Peace 11 EU fund to the tune of £40,000 towards the purchase of a brand-new DG-505. Tom Snoddy, club secretary, supported by Alan Mc Killen CFI delivered the story of his single-handed achievement to a packed extraordinary meeting in the clubhouse. Delivery is expected in January 2005. The winter months are being used to bring at least eight pilots up to Bronze standard with lectures on the written papers at the club to be followed by an intense gliding instruction week in early March. The new committee has as one of its main objectives to rigorously market its product and attract new membership. Various marketing initiatives are under consideration, including the launch of a new brochure designed to exploit the excitement and pure energy of our sport.

Seamus Doran

## Vale of White Horse (Sandhill Farm)

WE held our AGM in early January and our existing committee was re-elected, with the addition of Graeme Scott who runs our website. Our plans for 2004 include an expedition to Denbigh in late March, an open week, "Ed's week", the bank holiday week at the beginning of March, and a competition over the period of the Bank Holiday week at the end of March. We are also investigating the possibility of starting up a Wednesday operation.

Graham Turner

## Vintage Glider Club

RESTORATIONS in progress in Britain include the Muca 100 at Bannerdown, which is almost ready to fly, and the Minimoa at London, which needs only painting. The canopy is being put together by Peter Underwood. At Booker, our members now own the T-21b, and have had a fine closed aluminium trailer built for it. Graham Saw is re-fabricating and repainting his Lunak. Their Kite II is almost restored and should be flown this summer. Chris Raine and family took their Kite II to the 31st International Rally as the only British entrant; the distance and two ferry crossings prevented other British entries but the rally was a success with 30 gliders: single entries from Norway, Sweden, France, Switzerland,

Austria and Britain, and multiple ones from Germany, Denmark, Finland and Holland. The 32nd International Vintage Rally is to be held in August at Gliwice in Poland, where a new 1936 Salamandra is being built and where 13 wooden sailplanes are already airworthy. They include the last airworthy Jaskolka in Poland, recently purchased in Belgium. It is the first time that the VGC has been to Poland. The VGC 2004 Rendezvous Rally will be the week before at Jezow, the historic Grunau site. In the Czech Republic, two more Orliks have been restored to flying condition and their new Hols de Teufel should be ready this year. In France, an Air 100 and an Edelweiss have been restored to fly. In the Netherlands, a new glider museum, the Aviadrome, has been founded. All the gliders can be adopted, restored and flown by Dutch VGC members. This is a great example for other countries. In Germany, a new Hütter H28-2 has flown and a new Lippisch designed "Grune Post" is due to. A fourth airworthy Kranich 2B-2 is being restored along with two Zugvogel 3as. See page 15 of this issue for news of the Hortens that are being rebuilt in Germany.

Chris Wills

## Welland (Lyveden)

IT is with great sadness that we pen this report. Members of this club, and their respective families, grieve for the loss of our members John Heath and Philip Swinden in a gliding accident at a nearby club in January. More can be found in the obituaries (see right). The last club news omitted to mention that John Heath had won the club's 267 Cup, for the fastest 100km triangle last year. It is sad that he cannot read his name in lights here. The club winter maintenance is being taken on with heavy hearts as the field slowly recovers from its winter soaking. Many of our club members also knew Bob Sharman, and our respects and condolences are offered both to his family and to the nearby Peterborough & Spalding GC. Looking to the future, our *ab initio* week is set for April 19-23 subject to demand. Our Open Weekend is scheduled for May 8-9 but may be subject to move in line with the National Gliding Week. Our Flying Week is to coincide with Upwood's: August 7-14.

Strzeb

## York Gliding Centre (Rufforth)

THE officers elected at the AGM were: Richard Smith, Chairman, Howard McDermott-Row, Secretary and Paul Hepworth, Treasurer. Mike Cohler remains CFI. The club is delighted with its new two-seater, a lovely Grob Acro III, which has proved extremely popular. We are looking forward to having two glass trainers going cross-country to satisfy the increasing demand from our Bronze pilots who have contributed to increased membership in the past year or two. The new buildings that will comprise our new clubhouse are anticipated to be on site in the near future. This should give us a superb facility to cater for virtually all our indoor needs. We are currently awaiting planning permission to go ahead.

Mike Cohler

## Yorkshire (Sutton Bank)

THE approaching spring has brought some furious west winds and the return of the wave bar. Congratulations go to John Marsh for completing his Bronze in a little over a year from solo, and to anyone who made it to the seriously snowed-in New Year's Eve party. Regular visitors will be pleased to learn that, thanks largely to the effort of Peter Clay, Stuart Heaton, Kelly Janski, Chris Teagle and Chris Day, the dormitories and bunkroom have been extensively revamped. New lower ceilings, a fresh coat of paint, and some alterations to the furnishings have led to a 500% improvement! The club has also decided to sell the extremely well-equipped tourer caravan bought by the late Daphne Sharpe some years ago – contact the club for more details.

Alex May

## John Abbott – Midland, Staffordshire

JOHN (1934-2004) flew his first solo in 1948 as an Air Cadet at Shrewsbury School. On leaving school he did National Service in the army, was commissioned during his last week and promptly left to return to civilian life. He had two hobbies – fishing and aeromodelling – both of which he pursued with fanatical attention to detail. In 1988 he returned to gliding. He joined the Midland GC and bought a share in the Olympia 460 #18. It was around this time that Staffordshire GC was becoming established only a few miles from his home. He joined and shortly afterwards helped form a syndicate to buy the Olympia 419 'Wild Goose' originally owned by Sir Peter Scott, and set about restoring this beautiful glider to its original condition and colour scheme. At both clubs he is fondly remembered for his wicked sense of humour and barbed wit. He was very good at winding up the more self-important members and then deflating them mercilessly. Following a very successful career he retired four years ago only to be struck down by cancer. This was apparently overcome and he returned to flying and fishing. He was taken ill again just prior to Christmas and died peacefully, which is probably the only thing he ever did peacefully, in January.

Chris Ellis

## John Heath – London, Welland

JOHN died in hospital on January 18 after a gliding accident earlier in the day. Originally from the Doncaster area, he started gliding at Dunstable in 1986 when his job moved nearer London. In 1991 he established, in memory of his son who was killed in a road accident, the Adrian Heath Trophy, to be awarded to a Cadet annually at the London GC. In 1994 John became an Assistant Instructor at Dunstable and was for some time the Vice-Chairman. Then, anticipating retirement in 1998, he moved to Deenethorpe and soon joined Welland GC. He was Chairman from 2000 until 2002, at the same time continuing to instruct at Dunstable. John was an experienced pilot with 3075 launches for a total of 1120 hours in 46 different types of gliders, in addition he had 88 hours in his PPL log-book. John's experience and enthusiasm will be greatly missed by both clubs and his contribution to them over many years was recognised by the many members of both clubs who were at his funeral. He is survived by his wife Sue and his daughter Sarah, to whom we extend our sympathies in their tragic loss.

Meyrick Jones

## Robert (Bob) Sharman – Peterborough & Spalding, Vintage GC

DIFFERENT people will remember Bob (1922-2004) in different roles because he had such a full and varied life. Joining the Lincolnshire police as a 16-year-old cadet and after the war attaining the rank of Chief Superintendent, his career was interrupted by wartime service in the Royal Navy, where he served aboard Motor Torpedo Boats and was awarded the DSM for his part in saving his boat after the captain ordered it to be abandoned. His refusal to abandon did not go down well initially but was typical of Bob. In the early 1950s, he discovered gliding and threw himself into it with his usual gusto. He eventually became a civilian instructor for the ATC; was commissioned into the RAF VRT and became OC of the Air Cadet Gliding School at RAF Hemswell. For much of his life, he was a member of Peterborough & Spalding GC, where he was instructor, tug pilot and for some years chairman. He travelled Europe to attend VGC Rallies, where he was a popular character always ready to help. Following the death of his first wife, Mary, Bob visited relatives in Australia, where he went gliding and also met Sylvia, whom he married in 1995. Sylvia took to gliding and became a pilot in her own right. She has been Bob's dearest companion, supporting him throughout, and intends to continue flying. Bob also leaves behind a son, Richard, and a daughter, Annie. Last year at the club, a member

was heard to say "I hope I am as fit as that at 80". Bob was playing rounders with the kids and launching water bombs at the time. He is a great loss to the gliding community. I am sure that if Bob had a parting message it would be: "Get airborne, me boy, there's lift all over the sky".

Martin Ewer

## Philip Swinden – Welland

IT is hard to believe that Philip Swinden (1989-2004) joined us only last spring, such was the impression he made on all who met him. From the start it was obvious that he was going to be an exemplary club member: there early to unpack the hangar; leaping on the tractor to fetch cables; hurrying out to retrieve landing gliders. Philip had a maturity beyond his years whilst still maintaining the enthusiasm of youth. He had a fantastic ability to talk to anyone and a real sense of fun. His smile will stay in our hearts and minds for years to come. Taken from us just the day after his 15th birthday, Philip's natural aptitude and love of flying shone through. His ambition was to be a pilot in the Fleet Air Arm and already he had virtually reached solo standard in gliders. He was always eager to learn, and he had many interests, including sailing, fishing, the Scouts and the clarinet. Philip achieved so much in an all-too-short life that he is an inspiration to all of us fortunate enough to know him. His loss is a tragedy for his family, our club, the gliding movement and the world at large. Our thoughts are with his parents, Kevin and Gillian, his brother, Andrew, and his sister, Jessica.

Jane Cooper & Brian McDonnell

## Dick Toop – Dartmoor

WE have all been saddened by the death of Dick Toop (1919-2004). He lived his whole life on the family farm, birthplace of Francis Drake, some four miles south of our site. Dick qualified as a civil engineer. His chief interest throughout his life was in horses but he also learned to fly and for a while held a PPL. When in 1986 as Mayor of Tavistock he paid an official visit to the gliding club this interest was strongly revived; he joined the club and supported all its activities. He bought a life membership, took a share in a K-6 and flew whenever possible. Although never a great soaring pilot he claimed that even a few minutes flying solo did his ego and his liver a power of good. He was the kind of solid supporter we all need to keep the sport popular and inclusive. In 1997 he married his charming young Miranda for a period of great happiness. Dick will long be remembered for his enthusiasm, his humour, his unstinting professional help in erecting our hangar and clubhouse and for his inexhaustible fund of stories. He has been greatly missed at the club since he reluctantly gave up gliding at the age of 82. We all extend our deep sympathy to Miranda and to his step-family.

Phil Brett

## Edwin Whipp – Bath & Wilts, Inkpen, Bristol & Glos

IT is with deep sadness that we report the death of Edwin Whipp (1933-2003), just a few days before Christmas and his 70th birthday. Edwin had, until recently, been Lecturer in Electrical Engineering at Bath University. He started gliding in 1969 with the Bath & Wilts club at Keevil and flew at Compton Abbas and Inkpen before joining Nympsfield in 1976. He joined the long-established Standard Cirrus syndicate 252 in 1979 and particularly enjoyed taking the glider to Le Blanc and Chauvigny in central France, preferring the flatlands to the excitement of the Southern Alps. For many years he was an instructor at both Keevil and Nympsfield, and many pupils will have benefited from his quiet and unruffled guidance. Sadly, just when it looked as if he had overcome his illness, the final blow struck. Our deepest sympathies go to Patricia, the children and grandchildren.

Chris Hughes

# BGA Badges

No	Pilot	Club (place of flight)	Date
<b>DIAMOND</b> 662	Michael Davis	Wrekin	11/11/03
663	Richard Chapman	Bidford	20/6/03
664	Richard Jones	Cranwell	11/11/03
665	Thomas Rose	London	4/12/03
666	Jim McLean	Clevelands	11/11/03
667	Tim Davies	Cranwell	11/11/03
668	Peter Kingwill	Cranwell	26/11/03
669	Michael Gee	Lasham	10/7/03
<b>distance</b> 1-967	Michael Roberts	Cambridge	14/8/03
1-968	Charles Cooper	Bicester (D Downs)	26/11/03
1-969	Gareth Baker	Cranwell (D Downs)	12/11/03
1-970	Dave Postlethwaite	Chilterns (D Downs)	1-9/11/03
1-971	Michael Davis	Wrekin (Darling Downs)	11/11/03
1-972	Stuart Duncan	Wrekin (Darling Downs)	24/11/03
1-973	Richard Jones	Cranwell (D Downs)	11/11/03
1-974	Nicholas Newton	Booker (New Tempe)	4/12/03
1-975	Richard Chapman	Bidford	20/6/03
1-976	Thomas Rose	London (New Tempe)	4/12/03
1-977	Jim McLean	Clevelands (D Downs)	11/11/03
1-978	Tim Davies	Cranwell (D Downs)	11/11/03
1-979	Peter Kingwill	Cranwell (D Downs)	26/11/03
1-980	Ian MacArthur	Midland (Bicester)	15/8/03
1-981	Michael Gee	Lasham (Fuentemilanos)	10/7/03
<b>goal</b> 2-2996	Charles Cooper	Bicester (Darling Downs)	17/11/03
2-2997	Gareth Baker	Cranwell (D Downs)	12/11/03
2-2998	Paul Johnson	Essex & Suffolk	20/7/03
2-2999	Stuart Duncan	Wrekin (Darling Downs)	17/11/03
2-3000	Jim McLean	Clevelands (D Downs)	8/11/03
2-3001	Michael Abbott	Staffs (New Tempe)	1/12/03
2-3002	Tim Davies	Cranwell (D Downs)	10/11/03
2-3003	Shaun McLaughlin	PSGC (Nympsfield)	30/8/03
2-3004	Geddes Chalmers	Highland	15/10/03
2-3005	Rod Christie	Booker	6/5/03
2-3006	John Roberts	Midland (Nympsfield)	30/8/03
2-3007	David Smith	Deeside	5/12/03
2-3008	Ian MacArthur	Midland (Bicester)	15/8/03
2-3009	Julian Sutton	Borders (Fuentemilanos)	8/8/03
<b>height</b> 2-3010	Terry King	Wyvern (Benalla)	9/12/03
3-1622	David Rance	Midland (Aboyne)	25/9/03
3-1623	George Crawford	Oxford (Ormarara)	4/12/03
<b>GOLD</b> 2316	Paul Johnson	Essex & Suffolk	20/7/03
2317	Jim McLean	Clevelands (D Downs)	8/11/03
2318	Michael Abbott	Staffs (New Tempe)	1/12/03
2319	Graham Paul	London (Talgarth)	18/10/03
2320	Ian MacArthur	Midland (Bicester)	15/8/03
2321	Robert Lockett	Staffordshire (Portmoak)	3/10/03
<b>distance</b> 2322	Julian Sutton	Borders (Fuentemilanos)	8/8/03
Peter Sharpe		London	16/8/03
Mark Pickersgill		Kestrel (Bicester)	14/8/03
Paul Johnson		Essex & Suffolk	20/7/03
Stuart Duncan		Wrekin (Darling Downs)	17/11/03
Jim McLean		Clevelands (D Downs)	8/11/03
Michael Abbott		Staffs (New Tempe)	1/12/03
Shaun McLaughlin		PSGC (Nympsfield)	30/8/03
Rod Christie		Booker	6/5/03
Robert Lockett		Staffordshire (Portmoak)	3/10/03
Julian Sutton		Borders (Fuentemilanos)	8/8/03
<b>height</b> Terry King		Wyvern (Benalla)	9/12/03
Charles Hay		Booker (Aboyne)	22/11/03
Dave Paffett		Lasham (Aboyne)	9/10/03
Graham Paul		London (Talgarth)	18/10/03
Robert Lockett		Staffordshire (Portmoak)	3/10/03
<b>SILVER</b> 11358	Andrew Hepburn	Portsmouth Naval	30/8/03
11359	Bruce Duncan	Deeside	2/8/03
11360	Kevin Western	Ratflesden	31/8/03
11361	Stuart Duncan	Wrekin	17/11/03
11362	Ernest Armitage	Derby & Lincs	3/10/03
11363	Rod Christie	Booker	6/5/03
<b>100km</b> Pts 1&2	Shaun McLaughlin	Peterboro & Spalding	30/8/03
<b>Aerobatic</b> T J Brook		Standard Known	14/8/03
D Nisbet		Standard Known	26/9/03

**Shenington Gliding Club**  
www.gliding-club.co.uk

*Learning to Glide?  
No Course availability?  
Check out Shenington –*

## The Friendly Gliding Club

**We are special and this is how we do it:**

- Flying 7 days a week
- Grass/Hard runways (weather resistant!)
- Value for money courses – guaranteed number of launches
- Professional Instructors – maximum ratio 2:1
- Winch, Aerotow and Motorglider available
- A friendly welcome to all visitors

*Clubhouse, Bunkhouse – Bar facilities available to members and visitors*

**Shenington Airfield, Oxfordshire OX15 6NY**  
Tel 01295 680008 • Email: [gliding.club@virgin.net](mailto:gliding.club@virgin.net)



ORDER PARTS, REPAIR MATERIALS & ACCESSORIES FROM THE EXPERIENCED PROFESSIONALS

**WE PERFORM ON THE GROUND TO KEEP YOU IN THE AIR!**

To complement our existing workshop facilities you can now access a huge range of **Parts, Repair Materials and Accessories** from the comfort of your own home - 24 hours a day, most items available for immediate despatch.

Simply visit:

**WWW.SVSP.CO.UK**

*The Smartest Way to Purchase Materials!*

**SHOP ON-LINE IT'S A BREEZE!**

PASSAGE ROAD, ARLINGHAM, GLOS, GL2 7JR



TEL. 01452 741 463  
M. 07860 542028  
SALES@SVSP.CO.UK

## MASON RESTORATION

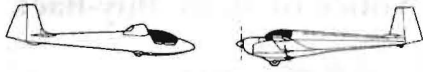

Glider and Motorglider  
CofA Inspections  
Weight and Balance  
Repairs and Refinishing on  
Wood and Glassfibre

27 Kellett Gate, Low Fulney,  
Spalding, Lincs PE12 6EH  
Phone: Dave Mason 01775 723737  
Email: silent.flight@virgin.net

**ATIS  
REAL** Weatheralls

TO LET

## Bicester Airfield To Let

- 327 acre grass airfield plus 1 or 2 "C" type hangars (approx. 4,185 m<sup>2</sup> each) and ancillary buildings
- Suitable for use by gliding operations
- Up to 5 year term available
- Available from Summer 2004

### All enquiries:

Andrew Sack or  
Nick Alexander • 0207 338 4000

andrew.sack@atisrealweatheralls.com  
nick.alexander@atisrealweatheralls.com

www.atisrealweatheralls.com  
22 Chancery Lane, London, WC2A 1LT

## Accident/incident summaries by Dave Wright

AIRCRAFT Ref	Type	BGA No	Damage	DATE Time	Place	PILOT(S) Age	Injury	P1 Hours
126	SZD Junior	3268	Substantial	20-Sep-03 1800	Talgarth	35	None	43

The visiting pilot, taking his first flight on type, returned to the airfield and failed to notice that the wind had changed through 180°. Finding himself too high approaching the up-sloping runway, he flew a second circuit but was again too high and on his third attempt he touched a wingtip as he straightened up, ground-looping the glider.

127	K-18	-	None	-Sep-03	Incident Rpt	77	None	607
-----	------	---	------	---------	--------------	----	------	-----

At 700ft on a winch launch there was a loud bang as the right rudder pedal became disconnected. The pilot released and flew a careful circuit to a crosswind landing. Subsequent inspection could find no wear or defect in the adjusters and they could not be made to slip if correctly engaged. (second time on this glider type. Previously, other pilot baled out)

128	SZD Puchacz-	-	Minor	-Sep-03 1430	Incident Rpt	-	None	-
-----	--------------	---	-------	-----------------	--------------	---	------	---

This was one of about seven gliders that had been left parked on the airfield during a break for lunch. While they had been adequately secured for the morning conditions this was not sufficient when the rotor from the wave system moved across the field. The gusting wind blew this glider down a slope and into a wall.

129	ASW 20	2589	Substantial	15-Sep-03 1410	Feshiebridge	73	Minor	570
-----	--------	------	-------------	-------------------	--------------	----	-------	-----

After a turbulent initial aerotow through rotor, when the pilot experienced severe lateral excursions requiring full aileron to control, he released at 1,400ft in 4kts of lift. This rapidly became 6kts and then over 10kts down as he headed for the airfield. His only option was to stall into the tree canopy, which caused substantial damage.

130	LS4 & Libelle 2806	-	Substantial x 2	11-Aug-03 1553	Didcot	52 44	None None	3,000 1,000
-----	--------------------	---	-----------------	-------------------	--------	----------	--------------	----------------

This MID-AIR COLLISION took place between two gliders flying in a national competition as they approached four gliders turning right in a thermal on track. Before reaching this the first pilot turned left, surprising the other pilot (unknown to the first) following very close behind and who was expecting him to turn right. Both pilots were lucky to make field landings despite extensive damage.

131	K-13	4634	Substantial	28-Sep-03 1720	Rivar Hill	70	None	218
-----	------	------	-------------	-------------------	------------	----	------	-----

The pilot was resolving after remedial training following an undershoot accident a month earlier (see report 143/03). After two well-flown dual flights he was sent solo. During the approach with 3/4 airbrakes he began to undershoot. He thought he had put the airbrakes away but had not and the glider undershot into a hedge.

132	Discus	4030	Minor	09-Sep-03 1710	Bicester	-	None	90
-----	--------	------	-------	-------------------	----------	---	------	----

The visiting pilot had a tiring day. He had trailed the glider from his club, rigged it, had a site and field landing check in a motorglider, then a 90-minute soaring flight in his glider. He then took a "hangar flight" it but found lift and landed after an hour, with the wheel up after using the u/c lever (on the same side as the m/g) as brakes.

133	K-23	2997	Minor	21-Sep-03 1730	Dunstable	43	None	11
-----	------	------	-------	-------------------	-----------	----	------	----

The winch launch, with the glider out of sight of the winch driver, started normally but the pilot did not rotate into the climb as it was too slow. He released the cable and tried to land ahead without using airbrake. This resulted in a pilot-induced oscillation in pitch and the glider bounced four or five times before stopping.

134	ASH 25	3909	Minor	12-Aug-03 1800	Lasham	47	None	3,000
-----	--------	------	-------	-------------------	--------	----	------	-------

This field landing accident took place during a competition flight. The very experienced pilot apparently was distracted by an unusual vibration during the final approach and failed to keep the wings level immediately after touchdown. As a result the glider ground-looped, damaging the tailplane.

135	ASW 22BL	3388	Minor	19-Jul-03 1615	Herriard	63	None	2,200
-----	----------	------	-------	-------------------	----------	----	------	-------

During the final glide in a competition flight the pilot misjudged his height and, too late, decided to land in a field that was now behind him. Turning steeply, and now below 200ft in the 15kt wind, he could not reach his field and had to land in a maize crop and ground-looped the glider.

136	SZD Junior	4042	Substantial	17-Sep-03 1615	Husbands Bosworth	68	None	124
-----	------------	------	-------------	-------------------	----------------------	----	------	-----

After a delay for landing traffic the glider was launched. At about 200ft the airbrakes were seen to open and the launch was abandoned. The pilot failed to notice the open brakes and did not lower the nose sufficiently to gain enough speed to round out. The very heavy landing broke the glider's fuselage.

137	Grob 109B Motorglider	G-BZLY	Minor	27-Sep-03 1705	Dishforth	51 40	Minor None	8 -
-----	--------------------------	--------	-------	-------------------	-----------	----------	---------------	--------

The motorglider pilot landed slightly fast and with little brake. As a result he mishandled the brakes and directional control, allowing the aircraft to swing towards a fuel bowser. The passenger applied correct rudder and stick to avoid the hazard but P1 then pulled full airbrake and wheel brake - tipping the aircraft onto its propeller.

138	IS-29	-	Write-off	-Sep-03 1530	Incident Rpt	-	None	-
-----	-------	---	-----------	-----------------	--------------	---	------	---

The glider was picketed with a trestle under both wings and a 25-litre water barrel holding each down. The tail was tied down using two ground screws. Despite this the glider was flipped on to its back by a severe gust, thought to be up to 70kts. The glider was written off.

139	Astir	5040	Minor	28-Sep-03 1642	Wattisham	32	None	1500
-----	-------	------	-------	-------------------	-----------	----	------	------

The very experienced pilot was seen "to carry out a textbook circuit and approach". Unfortunately he had forgotten to do his pre-landing checks and landed with the wheel retracted.

140	LS8	4450	Minor	28-Sep-03 1745	Aboyne	49	None	320
-----	-----	------	-------	-------------------	--------	----	------	-----

The visiting pilot was seen to fly "an absolutely perfect approach, two thirds brake, the speed was nailed..." and the landing was "beautifully held off" .... but the wheel was up.

141	ASW 19B	3716	Substantial	28-Sep-03 1751	Aboyne	45	None	28
-----	---------	------	-------------	-------------------	--------	----	------	----

This was the pilot's third flight on type. During the circuit he hit lift and found himself high on the approach with a slight tailwind, which he did not notice. Despite full airbrake he felt that he was not descending as quickly as in his previous glider types and, worried about overshooting, misjudged the roundout, collapsing the undercarriage. (cont on p64)

# Accident/incident summaries (cont. from p63)

AIRCRAFT Ref	Type	BGA No	Damage	DATE Time	Place	PILOT(S) Age	Injury	P1 Hours
142	ASW 27	4279	Minor	12-Sep-03 1320	Near Dufftown	-	None	142 680

During a mountain soaring competition flight the experienced pilot had to make a field landing. He failed to carry out his pre-landing checks and subsequently landed in the field with the wheel in the retracted position causing minor damage to the underside of the glider.

143	K-8	2192	Substantial	27-Aug-03 1334	Rivar Hill	70	Minor	218
-----	-----	------	-------------	-------------------	------------	----	-------	-----

The pilot started the approach with "plenty of height" but, after using full airbrake, realised he was sinking due to the wind gradient. He appears to have only partially closed the airbrakes rather than close them and the glider failed to clear the boundary hedge. (See also report 131/03)

144	K-6e	1530	Substantial	28-Jul-03 1405	Wortham near Diss	73	Minor	132
-----	------	------	-------------	-------------------	-------------------	----	-------	-----

After a Silver distance flight from a nearby club the pilot requested an aerotow retrieve. During the tow home the conditions were very thermic and he found it difficult to control, having very little aerotow experience. The rope broke and the pilot was lost so attempted to land in a field. After changing his mind twice he hit trees and a hedge.

145	Duo Discus	-	Minor	-Sep-03 1300	Incident Rpt	-	None	-
-----	------------	---	-------	-----------------	--------------	---	------	---

The very high winds picked up the parked glider and rolled it backwards into some trees causing minor damage to the tail, rudder, elevator and port wing. No details given of any picketing precautions taken.

## 2003-2004

001	Astrif CS	4953	Minor	19-Oct-03 1500	Syerston	23	Minor	16
-----	-----------	------	-------	-------------------	----------	----	-------	----

After two check flights the pilot was fully briefed for a first flight on type including a landing well into the field. During the approach the pilot encountered some wind shear, did not fully close the airbrakes, and appears to have become too slow to achieve a normal roundout. The undercarriage collapsed and the glider slid to a halt on its belly.

002	SHK-1	1623	Write off	05-Oct-03 1530	Bembridge	66	Serious	7
-----	-------	------	-----------	-------------------	-----------	----	---------	---

After a thorough pre-flight briefing the pilot made his first flight on type. On the aerotow the canopy opened and so he held it shut for the rest of the flight. Consequently, rather than lose the canopy, he elected not to use the airbrakes and landed fast, entered a pilot-induced oscillation and crashed heavily, writing off the glider.

003	K-6cr	-	Minor	-Oct-03 1545	Incident Rpt	-	None	-
-----	-------	---	-------	-----------------	--------------	---	------	---

After its last flight of the day the glider was landed to one side of the upwind end of the airfield, clear of the winch run. Following the next launch, the cable fell across the glider causing minor damage. While the launch was normal and the retrieve prompt, the slight crosswind drifted the cable across the full width of the field.

004	LAK-12	4388	Minor	10-Oct-03	Kitson Field	-	Minor	-
-----	--------	------	-------	-----------	--------------	---	-------	---

While preparing for launch the safety release pin on the glider's canopy jettison mechanism was removed (standard procedure). After a brief interval the canopy jettisoned without the lever being touched, falling on to the pilot's head. It is probable that a weak return spring/mechanism enabled the ejection when the canopy rocked laterally.

005	DG-500	4134	Substantial	18-Oct-03 1540	Parham	60	Minor None	824 1586
-----	--------	------	-------------	-------------------	--------	----	---------------	-------------

After a short flight the glider, flown by two experienced pilots, returned to the airfield. On the approach, having selected landing flap, P1 then apparently mistook the flap lever for the airbrakes. As a result he overshot the airfield and had to fly a very low turn through 180° and land downwind, ground-looping severely.

006	Alliance 34	4531	Minor	12-Oct-03	Milfield	51 49	None None	1336 62
-----	-------------	------	-------	-----------	----------	----------	--------------	------------

The visiting pilot was under training on a basic instructor course. As the area being operated from was a little tight for take-offs and landings he chose to land short to keep the take-off path clear. However, the area chosen was rough and one ridge forced the tail down, cracking the fuselage. The landing should have been made well into the field.

007	Falke Motorglider	G-BKVG 1215	Minor 74	19-Oct-03 None	North Hill 352	52	None	267
-----	----------------------	----------------	-------------	-------------------	-------------------	----	------	-----

During the take-off run the motorglider hit a bump in the airfield and became airborne at low airspeed. The pilot carefully avoided a stall but the glider sank back on to the ground after about 15 metres in another patch of uneven ground. The engine note changed, indicating the propeller had struck the ground, and the take-off was aborted.

008	Twin Acra II	3015	Minor	12-Oct-03 1738	Wattisham	44 22	None None	1250 0
-----	--------------	------	-------	-------------------	-----------	----------	--------------	-----------

The student was being taught approach control, roundout and landing. After a good approach he made a reasonable attempt at rounding out but held off about one foot high. During the not unusually firm landing a crack was heard. A very careful internal inspection found damage to the fuselage, which may have caused by a previous heavy landing.

009	K-13	-	None	-Nov-03 1320	Incident Rpt	39	None None	152 0
-----	------	---	------	-----------------	--------------	----	--------------	----------

During a trial lesson the instructor demonstrated ridge lift to his student but later became too low to safely return to the airfield. Realising this, he chose to land on a large common, briefing his student, and carrying out a textbook field landing. The glider was aerotowed out of the field while the pupil returned by car.

## LASHAM Gliding Society

### Notice of Share Buy-Back

In the 1960's Lasham Gliding Society raised funds through the sale of 5 shilling shares. This form of fund raising is now considered to be redundant.

In order to simplify the share structure of the Society the following resolution was passed at this year's AGM:

*By a resolution of the General Meeting of the Society on 12th April 2003, all certified shares in issue are cancelled and their par value is refundable from the society.*

Lasham Gliding Society will buy-back all such shares at their face value.

Please note that the deadline for claims is 31st October 2005.

For a Share Redemption form please contact the Secretary: Lasham Gliding Society, Lasham Airfield, Lasham, Hampshire, GU 3 4 5SS. Tel: 01256 381900

## ROYAL DEESIDE WAVE GLIDING SPECIAL

at the

**Loch Kinord Hotel ★★★**



G.P.S.  
N57° 04.590'  
W002°  
53.699'  
Only 1.5 miles  
from the  
**DEESIDE  
GLIDING  
CLUB**

**7 NIGHTS BED and BREAKFAST from £110pp**

Offering comfortable accommodation, good food, and a fine selection of Malt Whisky to enjoy beside coal fires. (Daily rates available)

**FURTHER GROUP DISCOUNTS FOR PARTIES 10+**

**Telephone 013398 85229**  
**www.lochkinord.com**

## GLIDER/AIRCRAFT INSURANCE?

Contact:  
**Tony Fidler**

Glider pilot for 35+ years  
40+ years insurance  
experience

Telephone/fax/write to:

**ANTHONY FIDLER & CO**  
**INSURANCE CONSULTANTS**  
27 High Street, Long Sutton  
Spalding, Lincs PE12 9DB  
Tel: 01406 362462  
Fax: 01406 362124

### Lake Keepit Soaring Club

Our friendly club atmosphere and all year round good gliding conditions, in Australia, will ensure memorable flying, whether first solo or cross country.

Contact Jim Stanley Phone +61 267697514 Fax +61 267697640  
E-mail [keepitsoaring@bigpond.com](mailto:keepitsoaring@bigpond.com)  
Web info: [www.users.bigpond.com/keepitsoaring](http://www.users.bigpond.com/keepitsoaring)

**www.market.aero**

**Buy and sell  
your sailplane online**

# Classifieds

Please send the text of your advert, and your payment, to Debbie Carr at the BGA office (not to the editor).

Please remember that, if you are emailing text, your advert may not appear unless we have received payment by the deadline

The deadline for classifieds to be included in the June-July issue of S&G is **May 5** after which any adverts received will be published in the following issue.

Text: 80p/word, minimum twenty words (£16). Black and white photographs: £6 extra Box number: £3 extra. All prices include VAT.

## FOR SALE

**SMOKIN VID 2004.** All new awesome gliding DVD. Order your copy today. Only £10 + p&p. Visit [www.smokinvid.co.uk](http://www.smokinvid.co.uk)

**K7** glider hangered Tibenham £1,500 ono. Tele. Malcolm Wood 07710 762588

**LS8a** 15m 2 1/4 shares or outright sale kent based. Very good gel, Becker radio, Bohli comp'. L-nav 5.8. Blue tinted canopy, lift top trailer with many accessories. £8500/share contact peter w. 07939816679/07764683068 for full details.

**15M TRAILER** Aluminium AMF, insulated, rewired, axles and brakes serviced, new jockey wheel. Would fit most 15-18m glass gliders. £1400 Tel: 01494 865647 Email: peter@hurd218.freeseerve.co.uk

**STANDARD JANTAR.** 38:1 glide. Good condition, New Clever Box Vario, Radio, Dolly, Fair Trailer. £7500 Tel: Plymouth 01752 227779

**DART 17R.** CofG hook, XK10 & averager, T&S, radio, parachute, oxygen, barograph, tow out gear, rigging aids, trailer. £4900 Tel: 01865 735833

## FOR SALE

Probably the best example of a Ka7 in the country! Very low time machine in immaculate condition with new C of A. Also, purpose built all metal trailer, with twin axles. Would suit ka7/13/21. £4,750 ono.

Phone Simon Waters 01304 375825, day or 01304 365189 eve.

# SF 25C Rotax-Falke

THE IDEAL MOTORGLIDER FOR TRAINING, SOARING, CRUISING AND AEROTOW



**SCHEIBE-FLUGZEUGBAU GMBH**

D-85221 Dachau, August-Pfaltz-Str. 23  
Tel: 0049 8131-72083 or -72084 • Fax: -736985  
**UK Contact: Peter Serge Fink**  
Tel: 01293 885147 • Fax: 01293 873214

# Skywings

is the official monthly magazine of the British Hang Gliding and Paragliding Association. £27 per annum subscriptions from BHPA, The Old Schoolroom, Loughborough Road, Leicester, England LE4 5PJ. Tel: 0116 2611322 <http://test.ebrd.com/skywings/home.html>

**ASW19B** Excellent condition. Aluminium trailer, Flight Director, Electric Vario, Radio. Winter Barograph, Parachute, T/O Gear. £13 500 Based Kent. Tel: 01892 722460 (Mike)

**DISCUS BWL** Complete outfit, mint condition, 600 hours, 200 starts. Excellent metal trailer. 01984 623227

**NIMBUS 2B** Excellent condition, low hours, Komet trailer, full panel and logger, GPS, etc. Tow out kit, 1 man rig, good gel, fully sealed. £1650 Tel: Dave Peters 01226 295596 work 0797 3718809 mobile.

**BERGFALKE 4** in pristine condition. Completely overhauled and recovered in 2000. New trailer, easy 2 person rig. £7000 offers. Tel: 01302 850913

**PIC 20b** 15M flapped glider 42:1 at 63kt. 12 months CofA. Tinted canopy. Normal mechanical instruments plus Tasman Electronic Vario/Averager. Air Pol parachute d.o.m. 1999. Factory built fibreglass trailer. 3 new tyres June 2003. Currently based Talgarth could be demonstrated elsewhere if you are really interested. Offers around £8000 Tel: 0117 9109111 (day) 01934 838096 (H) 07774 628110 (M) gordon.dennis@koala-pub.co.uk

**SKYLARK3b.** Exceptional condition throughout. Must be seen. Aluminium trailer, GQ Parachute, Garmin GPS, Rigging & Tow out aids. View Welland G.C. £3500. Call John Parsons 01832 270055 or email dave.chisholm@btinternet.com

**LS3a** 1978, 607 launches 2145H. One owner from new, outstanding condition - no accidents. Based Switzerland. Full panel, horizon, t/s, oxygen, ELT, parachute. Excellent aluminium trailer. £12,500 o.n.o. Enquiries to Simon Waddell: +41 79 775 1557, simon@leswaddells.ch.

**Omarama, New Zealand.** Return container space for 15m glider available for 2004/05 season. Cost about £2,000 for 3 months of great flying. Shared use of LS6 also available. Contact john.gorringe@blueyonder.co.uk 020 8274 0250

**ROLA-TRAC.** Excellent firm trailer base. No more sinking in mud. Click panels together, lay straight onto grass. Cost £750. Accept £500 ono. Richard 07710368338 (Surrey)

# Gliding Magazine

For the latest news, articles by leading writers, reviews and photos see <[www.glidingmagazine.com](http://www.glidingmagazine.com)>

**WITTER**

**TOWBARS TO TRUST**

- EC Type Approved bars use all car manufacturers fitting points
- Fitting does not affect the vehicle warranty
- Lifetime guarantee under the Witter Shield of Safety
- See Yellow Pages for your nearest specialist fitter or stockist.

**WITTER TOWBARS, CHESTER CH5 2NY**  
Tel. 01244 284500 • Web: [www.witter-towbars.co.uk](http://www.witter-towbars.co.uk)

**ASTIR 15m** single seater, nice condition, 1/6 share based at Southdown, trailer, parachute etc. Low running costs. £1450 Tel: 01293 884393 kjgouldstone@aol.com

**K6c** adapted for paraplegic flyers, optional hand operated rudder control (fully approved, with doc's). Really nice example of type. £3250 Tel: 01327 830897

**DG300 ELAN** in Komet trailer, parachute, oxygen, barograph, tow out gear. £20 000 Tel: 01905 381261

**SPORT VEGA.** Complete outfit including aluminium trailer, T/O gear, radio, electric vario and parachute. Syndicate disbanding Rattlesden based, £5500 ono. Tel. Martin 01284 766621.

**SZD Cobra** (1973). Complete with nearly-new trailer. £12,000 ONO. Ring John 07711 047832.

**DG100** GRP Trailer. Rigging aids and tow out gear. Filser LX4000 GPS/flight director and parachute. Based at Usk. £10 000 Tel: 01886 880236

**NIMBUS 3** 120,000 kms, ( 3 x round the world without an engine) £35 000. Buy now before prices go up from D.B. James. Tel: 01492 585130

**COMPAQ AERO** with all cables and software £35.00. **Demand Mask** with mic - New. Original cost £430 £75.00. **RAF 'H' Mask** with mic used but 'S' £35.00. **RAF 'P' demand mask** with mic used but 'S' £35.00. **Green Demand LP hose** with fittings - new £15.00. **Dynamic mics** to fit in masks with lead £9.00. Dickie Feakes 01869 245948 or 07710 221131 dickie@fsd.uk.net

**SLINGSBY SKYLARK II** complete outfit. Airframe good condition, trailer needs repair/replacement. Seen near Dunstable. Offers. Phone Graham 07905018998

**OPEN CIRRUS** 18.8M. Very good condition, oxygen, parachute, GPS and logger. Full rigging aids and good trailer. £8500 Contact Martin McCurdie office@longmynd.com 078660 25252 (M) 01694 722420 (eves)

**ASW22BLE AE50R** 1999 motor glider. Excellent performer and condition. 4 water ballast tanks, 3 fuel tanks, tinted canopy, side vent windo, bug wipers, Oxygen, Zander SR940 computer, GP940 logger including compass option and remote control column mounted controller, Cambridge logger and display, Sage competition vario, Dittel radio, solar panels for ground and trailer, 2 winglet sets (24.8m and 26.3m as per latest ASH25), Jaxida covers, Cobra FRP trailer yr 2000, with tow damper, electric one man rig, tow out gear July 1999 for Bayreuth WGC (4th), reprofiled and painted polyurethane wings and tail and fuse top, 760 hrs and 24 hrs engine. Contact John Buchanan Australia +61 7 5442 7509 or jbukes@hotmail.com-emailto:jbukes@hotmail.com>

**Cotswold Gliders**  
<http://www.cotswoldgliders.co.uk>

**BGA M3 FACILITY**  
**ALL TYPES OF WORK UNDERTAKEN**  
**PFA RATING**

**HIGH QUALITY SPECIALIST WORK IN**

Carbon, kevlar and glassfibre, wood and metal. Alloy airframe repairs a speciality. All types of repair work undertaken, from minor trailer rash to large insurance claim. Kestrel/Libelle rudder and aileron drive rebuilds, also NDT testing of rudder drive. Engine overhaul. Engine approval. Machining facilities for wing pins, axles, etc. Tig welding.

**If you require any of the above services, please contact us on any of the following**

Tel: Workshop 01993 779380 Fax 01993 779380  
Email: [office@cotswoldgliders.co.uk](mailto:office@cotswoldgliders.co.uk)  
Mobile No. 07944 885117  
or The Old Dairy, High Cogges Farm, High Cogges, Witney, Oxon. OX29 6UN

**VEGA 15/17** 1 Owner from new. 765 hrs, basic instruments, Garmin 100, parachute, tow-out gear. Metal trailer with new chassis. CofA to September 2004. Bargain £8200 Tel: 07770658438

**KE21** - Completely Refinished in 2-pack, Refurbished cockpits, Basic Instruments, 1 year C of A. £31,500 + VAT ono. Contact Paul Crabb - 01858 575665 or paul@crabb.biz

**ASW20 CL** - Completely Refinished in 2001, Lift top trailer, Oxygen, Basic Instruments, 1 year C of A, £19,750ono, Contact Paul Crabb - 01858 575665 or paul@crabb.biz

**WANTED**

**Wanted Single Seat Turbo.** Tel: 020 8398 8473

**SITUATIONS VACANT**

**Seasonal Instructor** required to assist Staff Instructor until end of October. Prefer minimum Asst. Cat. rating. Accommodation available. Send your details, marked 'FAO The CFI' to; Deeside Gliding Club' Aboyne Airfield, Dinnet, Aberdeenshire AB34 5LB

**Wanted MGIR CAA** Required, preferably retired full/part time. Oxford area. Ring 01608677208



**STEMME S10-VT**  
The Ultimate self-launch 2-seater  
125 knot cruise or 50:1 glide  
2463km gliding record  
Side-by-side comfort

For information, please contact:  
www.STEMME.co.uk  
Tel/Fax: 01277 823066  
MikeJefferyes@stemme.co.uk

**INDEX TO DISPLAY ADVERTISERS**

advertiser	page
Airborne Composites	14
Alpine Soaring	59
Anthony Fidler	64
Baltic Sailplanes	48
Benalla	14
Bicester Aviation Services	66
Black Mountains	48
BGA Courses	6
Bruno Brown	66
Cair Aviation	12
Civil Aviation Authority	6
Cotswold Gliders	65
CP West Ltd	11
Crabb Computing	7
Cumulus Soaring Supplies	50
Deeside GC	50
DG Flugzeugbau	inside front cover
EW Avionics	49
Flightmap Software	13
FlywithCE.com	15
Fuentemilanos	49
Glider Instruments	66
Hill Aviation	55
Ideal Microsystems	32
Jaca	23
Jaxida Covers	32
Joint Air Services	7
Lars Erik Bloom	11
Lasham Gliding Society	31, 64
Loch Kinord	64
London GC	37
LX Avionics Ltd	8
Mason Restoration	63
McLean Aviation	inside front cover
Midland GC	31
North Yorkshire Sailplanes	32
Optronic	11
Oxfordshire Sportflying	32
Pilot Flight Training	59
Protex	58
RD Aviation/AFE	inside back cover
Roger Targett	14
Scheibe Falke	65
Scottish Gliding Centre	66
SeeYou	32
Severn Valley Sailplanes	62
Shenington GC	62
Sky 4	66
Skycraft Services	25
Soar Minden	14
Soaring Oxford	54
Southdown Aero Services	48
Southern Sailplanes	outside back cover
Stemme Motorgliders	66
SZD Jesow	50
TaskNav	51
The Platypus Papers	32
The Soaring Centre	23
Weatheralls	63
www.refinish.biz	10
York GC	48
Yorkshire GC	51
Zulu Glasstek	51

**NEW!**

**See You Mobile**  
The latest in-flight program to run in your IPAQ - as seen at the BGA Convention  
Download your copy from [www.seeyou.ws](http://www.seeyou.ws)  
**Activation Fee £149.00**

**See You v2.6**  
Probably the best Task Planning and Analysis software yet - Try it today  
**Activation Fee - Still only £88**

Barograph and IGC Logger BGA Approved Calibration - All Types £15 + £6 return post

**Dickie Feakes**  
**Bicester Aviation Services**  
01869 245948 or 07710 221131  
[dickie@fsd.uk.net](mailto:dickie@fsd.uk.net)



Shenington Gliding Club offers Individual Tuition with Bruno Brown. Specialising in:

**CONFIDENCE BUILDING COURSES**  
**INSTRUCTOR WORK UP TRAINING**  
**GROUND STUDIES IN ALL GLIDING ASPECTS**

All courses will be tailored to your own requirements but will include:

- ✓ STALL APPRECIATION AND SPIN AWARENESS
- ✓ LAUNCH FAILURE RECOVERY TRAINING
- ✓ UNDERSTANDING THE DANGERS OF LOW FLYING

**"SAFETY THROUGH KNOWLEDGE" IS GOOD**

**SAFETY THROUGH UNDERSTANDING IS BETTER**

Talk to Bruno on  
**01295 258700**  
[www.glidetrain.com](http://www.glidetrain.com)  
e-mail: [brunobrown@tesco.net](mailto:brunobrown@tesco.net)

**GLIDER INSTRUMENTS**  
(M. G. Hutchinson)

PZL, Winter and Smiths Instruments repaired and overhauled.  
Contact us with your requirements.

Write or phone:  
'Tanfield'  
Shobdon  
Nr. Leominster  
Herefordshire HR6 9LX  
Tel: 01568 708 368

**THE SCOTTISH GLIDING CENTRE**  
*Portmouak*

For almost 70 years our members have been enjoying one of the best Ridge Soaring Sites in Scotland

Why not join us and see for yourself

**Scotland's Premier Training Site**  
**Training Courses for 2004**

Clubhouse accommodation, coravan and camping space

Call us on **01592 840543**  
The Scottish Gliding Centre  
Portmouak Airfield, Scotlandwell KY13 9JJ  
Web <http://www.scottishglidingcentre.co.uk>  
email: [office@scottishglidingcentre.co.uk](mailto:office@scottishglidingcentre.co.uk)



Service, maintenance, C's of A, repairs and rebuilds on composites, wood & metal,  
email: [mike@sky4aviation.co.uk](mailto:mike@sky4aviation.co.uk)  
Website: [www.sky4aviation.co.uk](http://www.sky4aviation.co.uk)  
**Tel: 01297 680360**  
**Mobile: 07810 517916**  
Branscombe Airfield, Branscombe, Devon EX12 3BL



Shadow

### Irvin-GQ Parachutes

RD Aviation is proud to announce its renewed distributor contract for Irvin-GQ safety parachutes. Irvin-GQ was formed in 2001 from the merger of Irvin Aerospace Ltd and GQ Parachutes Ltd. For more than 65 years, these two companies have been at the forefront of parachute design and technology. With many thousands of safety parachutes sold

world-wide, Irvin-GQ deserves its reputation for innovation, quality and reliability.

The Shadow and Silhouette safety parachutes are manufactured on the same production line and to the same stringent standards as their highly regarded safety and recovery systems (in use with the Military), giving that assurance of quality and reliability essential with the purchase of safety equipment.

The Shadow is a back-type parachute without seat cushion, for use in cockpits with limited headroom. Made from heavy-duty fabric, with a packed size 52 x 32 x 7cm thick it weighs just 6.8kgs. The 4.8m aeronautical canopy is designed for use in emergency escape assemblies and gives a smooth controlled inflation at high speeds. The canopy is rated for use at all-up weights of 115kg, speeds up to 150 knots and altitudes up to 12000ft ASL. An inflatable lumbar pad is provided for extra comfort. Carrying bag provided.

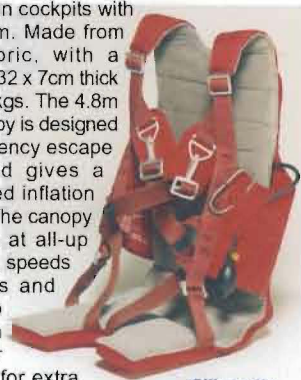

Silhouette

**GQ/SH £950.00**

The Silhouette has the same specifications as the Shadow, but with an integral seat cushion and cross-over harness. Dimensions: 127 x 38 x 6cm thick.

**GQ/SIL £950.00**



**FREE catalogue**  
Winter 2003/04

Contact us for your  
**FREE** copy

**All prices include VAT at 17.5%**

UK Carriage Rates:		Offshore UK & Rest of EEC	
Order value	Charge	Order value	Charge
Below £25	£2.99	Below £25	£3.99
£25-£100	£3.99	£25 - £100	£5.99
Over £100	£4.99	Over £100	£8.99

AFE/RD Aviation  
Pilot Shop, Oxford Airport,  
Oxford OX5 1QX  
Tel 01865 841441 Fax 01865 842495  
Email: tech@afeonline.com

## NEW



### ATR500

The younger brother to the popular ATR600, the 500 offers the same excellent manufacture quality and reliability as the 600 version, but at a more affordable price. Features include a 9 channel memory (easily accessed via the top dial), a dual frequency display — allowing you to have one frequency on standby and one active. Squelch and volume are handled via the lower dial, and when used in powered aircraft the 500 has a VOX intercom.

The ATR500 is a simple installation requiring a 57mm cut-out and 10.5 to 14v power input. With low power drain (150ma on standby and 1.8A during transmission) and at a competitive price, the 500 makes an ideal installation in gliders and homebuilt aircraft. Measures 178mm (without connector).

**ATR500 £769.00 New price — save £30.00**



### A Fine Week of Soaring

An exciting insider's view of the Mifflin, Pennsylvania regional contest from the back seat of a Duo Discus high performance glider, with 15-time US national champion Karl Striedieck at the controls. Flying at high speed at treetop level over the Appalachian ridges or climbing under majestic snow showers, we get a sense of how a champion pilots his craft. The supporting cast includes competition director Charlie Spratt, two-time world champion George Moffat, still a formidable competitor at 75, and the contest pilots and organizers.

69 minutes, video. Available on DVD or VHS (PAL)

*The best film I have ever seen on contest flying. The photography is super and the story line perfect.*

CHARLIE SPRATT, Competition Director

Juan Mandelbaum's new film, *A FINE WEEK OF SOARING*, is a must-see for anyone interested in sailplanes, especially contest flying. Filmed at the Mifflin Regionals, it is marked by stunning photography, much of it featuring the famed Pennsylvania ridges, up close and personal. In the 70 minute film, producer/director Juan, an accomplished soaring pilot as well as a professional movie maker, flies with Karl Striedieck in his Duo Discus on each contest day, and we get to listen to The Master's laconic and often amusing commentary on why he does what. Several other pilots are featured, showing varied viewpoints on each day's flight, with experience varying from a World Champion down to a relative newcomer. An interesting and helpful added feature is the use of SeeYou animation to show the tracks of some of the gliders. This film is a highly professional job and a delight to watch.

GEORGE MOFFAT, 1970 and 1974 World Champion

**VID/AFWOS £29.95 DVD/AFWOS £29.95**

### Looking for a career in aviation?

Airplan Flight Equipment are looking for further full and part-time staff in our Manchester and Oxford Airport pilot shops. You should be enthusiastic about flying, understand the needs of our customers and be able to learn about our wide range of products and services. Your daily workload will be interesting and varied — multi-tasking skills are essential! We offer flexible working arrangements, a friendly team atmosphere in a go-ahead company and competitive rates of pay.

Send your CV for the attention of  
Jeremy M Pratt, Managing Director,  
to: afe@afeonline.com



Find our latest news, products  
and on-line shop at  
**www.afeonline.com**

## CAMBRIDGE

The Cambridge 300 series is once again in stock at RD Aviation. Based on over 20 years of experience designing and building state-of-the-art instruments for soaring, advanced technology, including a 32 bit microprocessor and flash memory, makes the system versatile and easily upgradeable by the pilot. No more returning the unit to the factory or service dealer for firmware upgrades.

**MODEL 302** — Altimeter, Vario, Averager, Audio, Accelerometer and Secure GPS Flight Recording including engine detection

The 302 contains the specialised sensors needed for a modern soaring instrument, and displays all the information needed for efficient climb and cruise on a single 57mm panel instrument, ideal where panel space is limited.



**C/302 £1,595.00 New Price — save £200.00**

**MODEL 303** — Basic Navigation and Final Glide Display

The 303 display works in conjunction with the 302. Using 302 sensors and computing power, the 303-Nav combines GPS based navigation, wind measurement and final-glide calculation in a single, intuitive set of screens.



**C/303 £265.00 New Price — save £34.00**

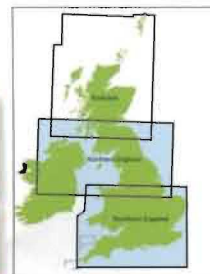

### CAA 1:500,000 charts Southern England

The new edition of the Southern 1:500,000 is due out on April 22nd this year. In order to guarantee your position in the start grid at this year's competitions why not order one from us by telephone or online at sales@afeonline.com and forego that last minute panic!

**SOUTHED30 £13.99**  
**Northern England**

The CAA's Northern England 1:500,000 chart is due for release 20th May. If you would like to back-order one please contact us by telephone or online at sales@afeonline.com.

**NORTHE27 £13.99**

**AFE**  
General mail order sales enquiries  
call our Manchester Office: 0161 499 0023

# Southern Sailplanes

For the purchase, maintenance and repair of your pride and joy, come to the most experienced people out there.

Membury Airfield,  
Lambourn Woodlands,  
Hungerford,  
Berkshire RG17 7TJ

Tel: 01488 71774 Fax: 01488 72482  
Evenings: 01488 682058 & 01488 688484  
Mobbles: 07808 328747 & 07774 429404  
Email: [office@southernsailplanes.freemove.co.uk](mailto:office@southernsailplanes.freemove.co.uk)

## So who's the best on paper...?

The same people who are the best on wood, glass, carbon, kevlar and paint.