



# VGC News

**No 55      Summer 1985**





## *The Vintage Glider Club of Great Britain*

President: C. Wills

Hon. Secretary: R. Traves

Hon. Treasurer: K. Crack

Rally Secretary: G. Moore

Sales Manager: P. Woodcock

Archivist: Sally Shepard

V.G.C. News No.55

SUMMER 1985

### EDITORIAL

The long winter gave way to a wet spring. Those of our gliders which were lucky enough to have had winter storage were brought out only to have their wood's moisture content topped up by deluges of rain. In Britain, one thinks that if only we can get through to March, then the winter will have passed. But to have had to wait until mid May before anything resembling a soaring day should occur... is a long wait indeed.

The Spring was livened up for the President by him being invited to give an account of the "objects and state of the VGC" before the Conference International de Vol a Voile (C.I.V.V.) in Paris on the 21st March.

In spite of being fully aware that he was in the presence of such great pilots as Hans Nietlispach, Edward Makula, etc., etc., who had flown our vintage gliders rather further and better than some of us are ever likely to fly them, C. Wills, being finally invited by Bill Ivans, the President, to speak, was able to give an account which appeared to be received like a breath of fresh air.

Unfortunately, the VGC's International events could not be accepted by the FAI for inclusion in their annual calendars, as the VGC is not one of their members. However, it has now become clear that our International events and their locations can be submitted to them for inclusion in their calendars, providing they are sent in by National Aero Clubs, in whose countries our events are to be held, which are members of the FAI.

---

### CAPTION TO COVER PHOTOGRAPH:

Wolf Hirth and Joan Price (then Joan Meaken) at the occasion of the 1937 British National Contest at the Derby & Lancashire Gliding Club, Bradwell Edge, Camphill. Wolf Hirth had come with Hanna Reitsch and Eva Schmidt to demonstrate the two-seater "Minimoa". Joan had been taught to glide by him in Germany and was then, in 1937, flying for the Sir Alan Cobham Air Circus. During the next year she owned the Rhönbussard, BGA 337, which is still airworthy in 1985.

## EDITORIAL cont'd.

It is now only a question of resolving these dates and locations early enough in the years, before the years in which International Rallies are to be held.

A letter which was received by C. Wills dated 3rd May from Barry Rolfe, Administrator of the BGA:

"Thank you for your letter of the 26th April and I had already heard from Tom Zeally and Ben Watson that you had a good reception at the recent C.I.V.V. Meeting in Paris.

I will now apply through the Royal Aero Club to the F.A.I. for the inclusion of your two 1986 events in the next International Calendar. I feel that they will be happy to comply with this request and I hope that this will be helpful for some of your other European Vintage Clubs." Barry Rolfe, Administrator.

From Barry Rolfe, BGA Administrator. 17th May 1985

### Extract:

"I confirm that the Royal Aero Club have now written to the F.A.I. Director asking for the inclusion of the Vintage Rallies on the 1986 F.A.I. International Calendar."

We thank the BGA, and their administrator, for giving us so much encouragement and help. We also thank the C.I.V.V. and in particular its President, Bill Ivans, for inviting us to take part in their proceedings.

As can be noticed in this VGC News, there is unprecedented building and restoration activity in Britain, and everything points to us having a very exciting future.

To our knowledge, none of our aircraft have suffered exposure and wind during the previous winter. We congratulate our members for keeping their aircraft safe.

### BGA Certificates of Airworthiness based in Europe

Already the first T.31 has gone to Europe. Before it left Britain, it was able to obtain a BGA C of A, which it had not previously had, on account of it being in Air Training Corps Service.

Other T.21s and T.31s will probably soon follow it to Europe. Because of difficulties which may be experienced in obtaining Certificates of Airworthiness for these aircraft from some European airworthiness authorities, it will be far easier and cheaper if the BGA C of A's can be annually renewed by BGA Inspectors in Europe.

Recent information received at the RAFGSA Centre at Bicester suggests that, although at present it is not possible to know which RAFGSA BGA Inspectors will be stationed on RAF airfields in Germany next year, because of posting, it will be possible to provide a list of these inspectors and which RAF airfields they are on next year when the C of A's have to be renewed. These RAF airfields are Bruggen, Laarbruch, Gutersloh, etc.

Therefore, it would seem that the prospects are still good for the renewal of T.21 and T.31 BGA Certificates of Airworthiness on the continent of Europe. This should also be for any Slingsby Grasshoppers and Eon Eton (SG.38) Primary Gliders that should also find themselves in Europe.

### The International Rally, Amlikon - 20th-28th July, 1985

So far the indications are that this is going to be a successful event with first class organisation from Hugo Roth and 4 Piper towplanes.

We have heard that the Hungarian team are coming with Cimborá and Vöcsök and perhaps even their P.O.2 towplane. Among them will be Eva Simo Avararosy and Imre Mitter.

So far as is known, the British entries will be:-

T.21C - Colin Street and Gang

T.31 - Colin Anson, Mrs. Anson, Ian Smith and Jane & David Ballard.

King Kite - David Jones

Slingsby Sky - Richard Moyses

Scud 2 - Peter Bourne

Rhönbussard - C. Wills

Harbinger - Geoff Harrison and Syndicate

T.21b - Phil Lazenby, Michael Maufe and Tony Maufe

Prefect - Robert Sharman

With the team will also be Ted Hull, who hopes to fly a Swiss glider, Geoff Moore and others.

Hugo Roth's address is: Santistrasse 1, 8472 Seuzach, Switzerland. Tel. Switzerland 52 22 62 84.

Australia will be represented by Mr. & Mrs. Kevin Sedgman. Kevin is one of the pioneer glider pilots of Australia. He is, and has been for years, the organiser of the Scouts' Gliding Club at Blanchtown, South Australia, which has operated an ES.49 two-seater. He himself has been flying an Eon Olympia, which had its nose modified for installation of an engine.

Oldtimer Meeting on the Wasserkuppe - Saturday & Sunday, 10th & 11th August 1985

This is to be run by the OSC Oldtimer Segelflug Club Wasserkuppe and will be held together with the Otto Lilienthal Remembrance Celebration.

The Oldtimer Meeting will be open to aeroplanes and cars as well as sailplanes. On Saturday evening a hangar dance is planned and old films will be shown.

As the Wasserkuppe seems at last to be again in Aufschwung (a great leap forward?) we hope that as many of our gliders and their owners as possible will be present after our International Rally at Amlikon. Those wishing to take part should inform Karl-Heinz Kellermann, Beethovenstrasse 64, 6000 Frankfurt 1, West Germany. The members of the OSC are looking forward to welcoming us.

From the Rally Secretary - Geoff Moore

National British Rally - 18th - 25th August 1985, Long Mynd

As already announced in the Spring VGC News, our big rally in the UK this year is at the Midland Gliding Club, Long Mynd, Church Stretton, Salop. The beautiful Rodi Morgan Trophy will again be presented for the most outstanding performance during the week, together with other awards. A daily prize will be awarded to the previous day's winner at each briefing.

If you are undecided, it is still not too late to enter, either for a few days' visit or for the whole week. Launching will be by winch, supported with bungee launches. These will be specially organized for us. A barbecue will be arranged for us during the week. Parallel with our rally, a Task Week will be run by the Midland GC... and you might like to try the local tasks. We shall be setting up shop in the marquee. Hopefully, with stronger stakes, it will remain up for the whole week and will not be blown down as it was last year on Sutton Bank. Camping is free. Temporary membership is £3.00 per day, but need only be paid for the days that you fly. Winch launches will cost £2.20. Official VGC entry is £5.00 per pilot. Local accommodation addresses are available. Please advise the Rally Secretary if you intend to come. Address is: Geoff Moore, "Arewa", Shootersway Lane, Berkhamsted, Herts., HP4 3NP. Tel. 04427 73258.

End of Season Rally and Presentation of Prizes, Wycombe Air Park - 28th-29th September 1985

The Booker Gliding Club, High Wycombe, Bucks, have invited us for a two day rally on 28th and 29th September. The VGC Annual Awards presentation, together with a

formal buffet, will be held in their restaurant, Wycombe Air Park - on site, at 7.30 for 8.00 p.m. on Saturday, 28th September. The restaurant, on the ground floor, together with its own licensed bar, will be exclusively reserved for ticket holders only. The Open Table Buffet will consist of cooked meats, salads, vegetables, fruit trifle, gateau, cheese, biscuits and coffee. Tickets (£5.00) (cheques made payable to the VGC) can be obtained from Geoff Moore either by post (please send s.a.e.) or from David Richardson or Margaret at Booker.

There is no overnight accommodation at W.A.P. other than own camping on site, which is free. Local accommodation addresses can be forwarded.

Please obtain your tickets early. These functions are always a sell-out!

British Vintage Rally, Usk - Club Gleidio de Cymru Cyf (South Wales Gliding Club)  
4th - 6th May

Should the SW prevailing wind blow, some of us realised that this would come straight from the Bristol Channel and would be damp. Whatever the exact direction of the wind during those three days, we did have intermittent rain storms and rigged fliders became very wet. Because of this, the owners of three of the sailplanes, two of which had clear doped fabric, decided that it was unwise to rig for the whole weekend. The rain would have gone straight through the wings into the casein glued structures. More coats of dope and/or coats of clear varnish might have prevented this.

The sailplanes present were:-

Bergfalke 3 BGA 1464 - G. Beardsley and his family and partner.

Kite I BGA 394 - Ted Hull

Moswey 4A BGA 2227 - David Slobom

Meise BGA 2080 - Thoby Fisher

Rhönbussard BGA 337 - Chris Wills

The Bergfalke 3 currently holds the British two-seater distance and Goal Flight records for a flight from North Hill to the East Coast of 428 kms. For the weekend it was left rigged outside as it only has an open trailer... but, because of this, it did more flying than all the other vintage gliders at the rally. Also flown and kept up was the magnificent Moswey 4, by Ted Hull and David Slobom. Some weak thermals did reveal themselves on the first and last days.

We were glad to have with us on the first day, Gabor Fecacs from Hungary, who brought greetings from all our members there. He had been in London for a one week Computer Software Course. We were sorry that he could not have been with us longer.

We were visited by the Gillmores and McFaddyens from Aston Down, and Geoff & Joyce Moore, our Rally Secretary, came without a glider, as did David Jones.

During the rain Chris Wills showed video tapes of old gliding films in the club house.

Many veteran glider pilots were encountered. One of these was Rodger Reffell, whose father had been aerotowed around the Schneider Trophy Circuit in the RFD sailplane in 1931 and had been a pre-war owner of the Tern.

Everyone retired in good spirits, more than ready to take part in the next VGC rallies. They were amazed to notice how conditions improved as they travelled east of Bristol. The rest of the country seemed to have had a fine soaring day.

Based at Usk were the Olympia 419, BGA 1051, owned by Messrs. Waldock, Voyce Murphy and Ellis, a club Eon Olympia and Ka7.

We are sorry that some of our members had so far to go for such wet bad weather. Such is the cruel school of life concerning weather over Britain... especially this year. However, the new environment was at least a change for everyone.

As usual, we were received with great friendship by members of the South Wales Club and we wish to thank them for their hospitality.

The Late Spring Bank Holiday Rally at the RAFGSA Centre at Bicester  
25th, 26th and 27th May, 1985

As was the previous rally at Usk, and last year's previous rally at RAF Bicester, this will be remembered as being rather a wet occasion. Once again, this was more than made up for by the wonderful hospitality of the RAF.

Whereas last year at Bicester, the weather did not allow us to have any flying, this year we were able to get airborne on the afternoon of the first day and during the morning of the second day, the afternoon of the second day and the whole of the third day being "washed out". Needless to say, as happened last year, the days after the rally looked to be the finest soaring weather of the year.

Gliders present were:-

Mu 13d-3 BGA 1937 - Harry and Valerie Chappel (1943 built)

Grunau Baby 2b BGA 2237 - owners as above (war-time German built)

Mg 19a BGA 2903 - C. Wills, Tony Smallwood & Co.

Rhönbussard BGA 337 - C. Wills (1937 built)

Bergfalke 3 BGA 1461

Harbinger BGA 1091 (1947 designed)

Moswey 4A BGA 2277 - Ted Hull and David Slobom (1950 built)

Kite 1 BGA 394 - Ted Hull (1939 built)

Eon Olympia BGA 997 (1961 built)

Gull 1 BGA 378 - Tony Smallwood (1938 built)

Skylark 2 (special) "Phoenix" BGA 724 (1954 built)

As can be noticed, there was a large turn-out which was unfortunately not supported by the weather. However, we did better than last year, and the following gliders are known to have had flights of more than an hour:-

Mg 19a  
Moswey 4A  
Harbinger  
Mu 13 d-3

We were pleased to have Kevin Sedgman and his wife with us. Kevin is one of Australia's original glider pilots. He had his first taste of British thermals. Of the gliders present, we think that everyone will agree that the Shenstone/Czerwinski "Harbinger" was the sensation of the rally. It is now beautifully restored with transparent fabric and new canopy. It is a worthy successor to the Sto Jeden and "Rekin". (The PWS 101 and PWS 102 which were Poland's greatest sailplanes before the war and were also designed by Czerwinski.) It was designed to be a trainer for pilots who were to fly the Olympia sailplane which, in 1947, was in general use in British clubs. At that time the BGA favoured side-by-side seated trainers, and thus the Harbinger only came 5th in the 1947 BGA two-seater design contest. It is a tragedy that such an excellent design could not have been placed in production. It was left to Fred Coleman to build us one in his home. It is thought that both Shenstone and Czerwinski were in Canada when they designed the Harbinger. One more Harbinger was built in that country, where it was recently placed in a museum.

The RAF hospitality ran to wet weather storage of gliders in their hangar, and an excellent cheese and wine party on Saturday night. We thank them all, particularly Paddy Hogg, for their hospitality and for inviting us to come again next year.

The Grunau Baby Rally

Christian Kroll has reported that this took place as planned near Hamburg during the Whitsun weekend, and was fully successful. Details of this event will appear in our next VGC News.

### Wycombe Air Park in Upswing

Although the members of this gliding club are still not aware of it, there are soon going to be six, if not seven, vintage gliders based there. It only remains for their owners to decide on days when they can all be there together, to help each other rig, etc., and then there can be a grand parade of vintage gliders before the startled club members. WAP is in a good position for vintage gliders to assault Dunstable, Lasham, Bicester, Haddenham, Weston on the Green... or to at least use them as turning points!

Wycombe Gliding Club will welcome Vintage members and their gliders. Towplanes and personnel for rigging will be available. If possible ring: Chris Wills 0491 39245.

Another Hütter H.17a, BGA 321, originally built by Scott and Zander in 1937, has been found in a Suffolk barn by David Almey of Peterborough Sailplanes. He is now doing it up and expects to have it airworthy by the end of the year. He had landed his glider in a field and, while diplomatically explaining to the farmer its reason for being there, discovered from him that he had a glider stored in a barn which had been brought there long ago. The farmer then said "Well, I suppose you'd better 'ave it if you want to fly it", and David bought it on the spot. Such stories are from dreams... but this one is true. David also has major components of the Hütter H.17a, BGA 818, built by Ottley Motors in 1957, which had been the property of the late Mr. Richardson. Both his Hütters are the short aileroned earlier version, which was first designed in 1934 in Austria.

Components of another H.17 are owned by Paul Williams of Warwick. We believe that if the components of this Hütter could be together with those of the above, we would even have another complete Hütter.

It would seem that by the end of this year, three Hütter H.17's will be airworthy in Britain.

### Hütter H.17 plans

As at least 12 sets of these have been sent out to members in Britain, Holland, Germany and Italy, we can well imagine that other H.17's will soon be built. The original drawings were kindly presented to us by Ernst Sanders last summer at Terlet. Prints have been made from these.

### The Krajanek, BGA 655

We are happy to report that this is airworthy and has been bought by Mike Birch of Wycombe Air Park. This is a just post-war built Czech aerobatic soaring glider which was imported by the legendary Ladislav Marmol in 1950 and holds the British single-seat duration record, flown over the Dunstable slope. It weighs only 340 lbs and so it should soar very well. Its Czech registration was OK-8592. Until now, the Krajanek has been based in the North of England.... previously at Camphill, and more recently... at Blackburn.

### The Gull 3, BGA 643

We are happy to announce that Mike Beach was able to buy this aircraft, which was kept in storage since 1971 near Deddington, Oxon. The outer section of one wing is damaged through damp but the rest of the aircraft is still in good condition. As another Gull 3 is being built now, by members of the Blackpool & Fylde Club, we hope that next year there will be two Gull 3's. The Gull 3 is a lighter, cantilever, version of the Gull 1 which showed very good flying and handling characteristics. As its first flight was during the war, and its construction was too expensive to be built after the war, it is another of the vintage gliders which, due to the war, never had a chance to show what it could do. The famous racing driver, Prince Bira of Siam (Thailand) bought the Gull 3 and owned it during 1944 and 1945, when gliding was theoretically banned in Britain. He flew it, with his West Highland terrier "Titch", to 12,000 ft. There is a compartment for the dog behind the pilot's head. The Gull 3 will be repaired after Mike has completed refinishing his Rheinland, which is taking hours of work.

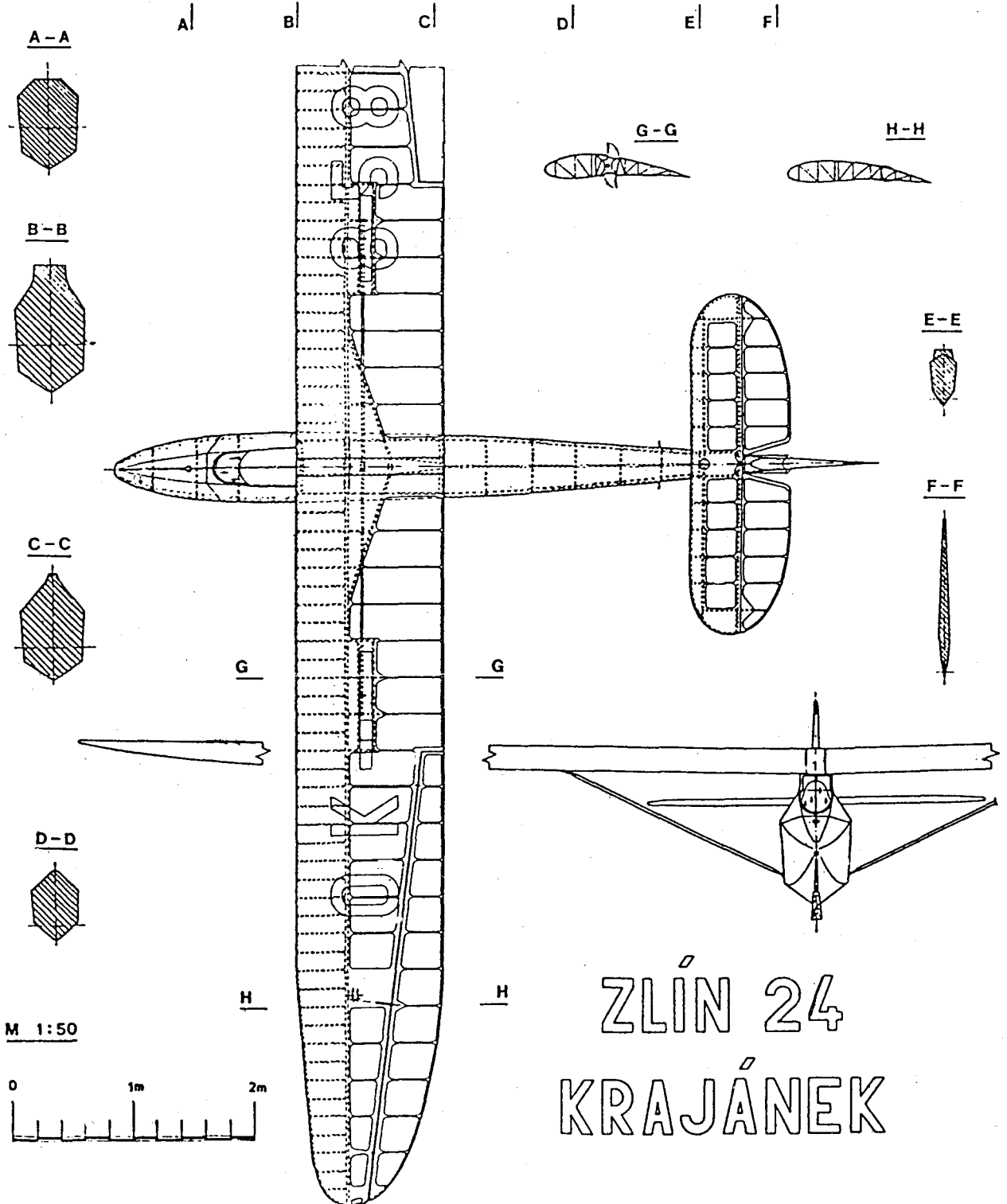
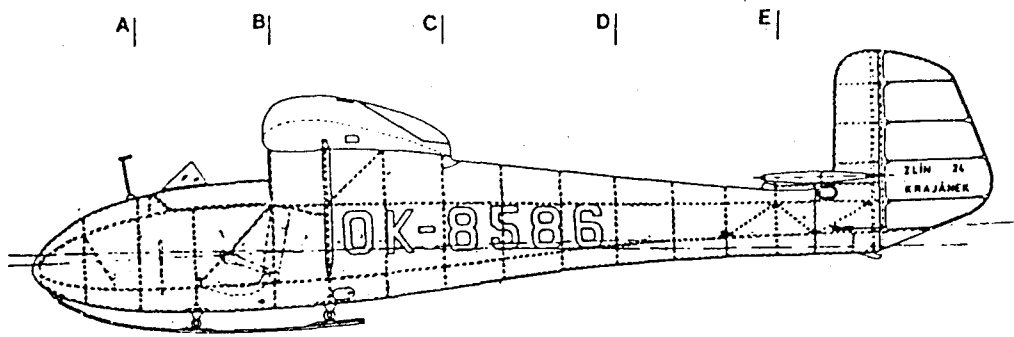

ZLÍN 24  
KRAJÁNEK

The T.31, WT-871 was retrieved from Upavon and brought to BGA C of A standard by C. Wills at Wycombe Air Park. All that was needed was superficial corrosion removal from all struts, lubrication of pins, etc. and the repair of holes in the fabric. WT-871 had done 32,900 launches and over 1,700 hours flying, which averages out at just over 3 mins. a flight.

It was felt that few other aircraft in the world could have given such service and still have been in such good condition, although it had had a major overhaul at Slingsby last year. We believe that all other ATC gliders have given such service. We believe that at least one of them should be put in the place of honour in the RAF museums.

### Spruce, Aerolite Glued, Structures

Clearly no gliding authorities in the world should ever doubt their integrity after the service they have given the British ATC. They are still as good as when they were new and should have many more years of life.

### T.21's and T.31's

We have heard that instructors at more than one ATC Unit in the West of England are getting together to buy the aircraft. Such is their love for the gliders, which they have trusted for so many years.

### An Eon Eton (SG.38)

We believe that our Rally Secretary, Geoff Moore, is to buy the partially restored SG.38 from Robin Traves' school for his next restoration project. It is being restored in the old tradition with clear fabric and would be approved for aero-towing. Geoff and his partner have, besides owning a Mu 13d-3, already restored a 1944 German Grunau Baby 2b. He has also organised all our rallies. Clearly, we have never had a more worthy Rally Secretary... and member of the VGC. We thank him and also his wife Joyce for putting up with us.

### The B.A.C.7

Tony Maufe reports that his father has now finished a new fuselage for this project and has, after lengthening his workshop/garage, started on restoring the original 1935 Drone wing, which, without cut out in the trailing edges' centre for propellor, was similar to that of the BAC.7.

### The Film "To Fly"

This film is to be produced, using the new IMAX technique. Films of this type can only be shown with special equipment. Only the Museum of Photography, Film and Television in the centre of Bradford can show these films in Britain. The 350 mm wide film is drawn out of and into at least 4 ft. diameter drums, horizontally across the projector's lens, to which it is held by vacuum suction. It is projected on a screen as high as a five storey building with totally clear definition from undistorted film. Such definition was only previously comparable to that obtained from glass plate negatives. The director of the film is an 82 year old American. It is clearly another counter attack by the film industry to win back television viewers into the cinemas. No television could ever rival such dramatic effect.

The reason for us mentioning this film is that Southdown Aero Services have been overhauling their Sir George Cayley 1851 Man Carrier to take part in the film. Derek Piggott is to fly it again from bungee launches. The above aircraft, which was the first to carry a man, has been exhibited at the Science Museum, South Kensington, the RAF Museum, Hendon, and at another museum further North.

The 1927 RRG Falke Replica (1931 Slingsby Falcon 1) is being finished off in case it can be flown for the film, which will be shot during the first part of June. A great attempt is being made to find a sponsor for the Falke to recover the huge financial outlay needed to build it. If a sponsor cannot be found, it will be offered for sale. We hope very much that this masterpiece of workmanship can be kept in Britain or Germany, airworthy.

The Minimoa, BGA 1738, which was restored by Southdown Aero Services in 1971/2, has now been sold to John Karlowich of Atlanta, Georgia, USA (address: Box 160, Kingston, G.A. 30145, USA). John is a very experienced pilot, who was once in the US Team. We are sure that he will be a good owner for the Minimoa, which is, at time of writing, still at Lasham. John is a member of the VGC.

Ken Fripp, whose firm has also restored the Hütter H.17 BGA 490, is at present not well with heart trouble. We hope that he will soon recover. He has been a true friend of the VGC.

#### The Film Show

Jan Scott kindly brought the film "Gliding Till Now" into the country for three days (it is now only available in America through the NSM). During this time, it was shown to Dunstable members on Saturday, 9th March, who were, we believe, "spellbound". C. Wills then managed to have it copied on the U-matic and VHS video tapes, so it can be kept for future generations... and any number of copies can be made.

The film more than brings back the atmosphere of the pioneer time of gliding, and especially the 1930's, when many of our gliders appear when they were new. There are the heroes from the days of glory... young and alive. Just to see them again is a tremendous experience for those who can remember them.

It must be remembered that the late Lawrence Wright made the film "Gliding Till Now" and we shall be for ever indebted to him for collecting together such material. We are also indebted to Jan Scott of the Vintage Soaring Assn. of America for bringing it back to us for copying and allowing us to show the film at Dunstable.

C. Wills has also had copied on to video tape Dunstable films which include the 1936 "Plane Sailing", which has sound. Installing sound tracks on to the silent films has caused problems with synchronisation. It is planned to sell two video cassettes... one of "Gliding Till Now" and other pre-war gliding films, including "Plane Sailing" in an attempt to recover considerable financial outlay.

#### The Film "Time of Your Life"

On Wednesday, 10th April, our members, David Bramwell and Colin Anson, were involved in making a television series film "The Time of Your Life" using their T.31 on the airfield of Hatfield. The film described events in 1931 when Barbara Cartland, now 85 years old, was aerotowed from that airfield in a BAC 7 by a Cirrus Moth. Barbara Cartland herself took part in, and enjoyed, the flying in the T.31 and Tiger Moth which was kindly brought over from Duxford by Mike Russell and was the towplane. We understand that archive film of the original flights was used and was "faded" in to the new film. That Wednesday was the only day of suitable weather, for the film, that we have had before or since this year. The film will be shown on television. Noel Edmunds was "anchor man" and interviewer.

#### GERMAN NEWS

##### West Germany

Karl Kässler, Director of the Luftfahrtbundes Amt, has stated that his office will look more sympathetically upon oldtimer aircraft, in spite of there sometimes being no information on them. This is after it was becoming apparent more and more that oldtimers were stealing the limelight at air displays, often from the new products of the aviation industries. This change of attitude dramatically came to a head with the planting of a Ju 52 from America in their midst!

We hope that this attitude will also influence the growth of the oldtimer glider movement in Germany. It seems to us that until now too often old inspectors have to be found to give C of A's to old gliders and that it is now time that young inspectors should be initiated to the ancient art of C of A work on old gliders. Unless this happens, a disaster situation may arise for old gliders in Germany when old inspectors can work no more.

### Finance for the Wasserkuppe Museum

The Museum's organisers have received good news. The Minister of Economy for Hesse in Wiesbaden, Dr. Ulrich Steger, has informed them that the Land of Hesse is prepared to pay up to 70% of the about 2.8 million DM needed to found the German Gliding Museum on the Wasserkuppe. Already the museum has 24 original old sailplanes, countless models, replicas and a large archive of photographic and written material. Minister Steger said that the museum would not only be of interest to the people of Hesse, but to all Germans. It will emphasize the influence of German gliding on the world wide development of the sport and on aviation in general. Also, the museum would make the Rhön to be of special interest to foreign tourists.

### The Oldtimer Club (OSC) Wasserkuppe

Two years ago they finished the restoration of an ES.49, the first 2-seater designed and built in Germany after 1945. They then tried to restore a Grunau Baby 2b, but this was found to have too much glue failure to warrant its restoration. So they decided to restore a SG.38. We believe that this has now been finished. For some time they have decided to attempt to build a DFS Habicht aerobatic sailplane, but the project was held up through some of the vital wing drawings being missing. However, it was discovered that the Habicht had been built in Turkey under licence between 1945 and 1949. Sure enough, in Turkey, a complete set of Habicht drawings was located, but the cost of having them copied was so high as to make the idea impossible. However, negotiations at the highest diplomatic level have achieved a copied set of Habicht drawings at, we believe, reduced cost. The reason for the, at first, very high cost is now apparent. There are hundreds of drawings revealing every smallest detail of the Habicht. There are so many Habicht drawings (even more have arrived from a source in Germany) that it has taken hours and hours for Josef Kurz and Karl-Heinz Kellermann to sort them out! It would seem that some parts of the Habicht have already been built. Projekt DFS Habicht can now go forward without, we hope, any more hindrance.

The Wasserkuppe is to hold an Oldtimer Rally for gliders, aeroplanes and cars on the 10th and 11th August. All OSC members are asked to help run it. We ask our members to patronise it with their gliders if they can for it is just possible that this year will be a turning point in the Wasserkuppe's significance concerning gliding history.

### The Film "From the Wasserkuppe to Baron Hilton"

This film is being produced this year using new film material as the old films were often thought to be of not good enough quality. It is well possible that Peter Riedel's books on Wasserkuppe history have inspired the creators of this film. Peter is, or has been, in Germany advising the direction of the film. As a team from the Wasserkuppe visited the Jungfrau Joch in Switzerland in 1931, with the Fafnir, it has been decided to re-enact this, not with the Fafnir, but with a Ka 8. Klaus Heyn advised them that a Fafnir would be too heavy. For this launching, a new Bungee rope is being ordered from a firm in England. We believe that film crews may arrive at some of our Oldtimer Rallies to re-capture the old Wasserkuppe gliders on new film in full colour!

The Munster Oldtimer Club's Minimoa D-1167 is now fully restored by Rainer Willeke and has been inspected by Horst Kiefer. It has also been flown. We hope to admire its full beauty at Amlikon.

The Munster Oldtimer Club's Goevier 2 D-1080 is ready to fly. It had been intended to build an original Goevier canopy for it if drawings could be found. Sets of drawings have now arrived from Wunsiedel where the Goevier was built by club members, from P. Selinger and 38 Goevier drawings have also arrived from Australia, where Allan Patching also is guarding a set.

The Goevier 2 will fly as it is this year, but will be restored with original canopy during next winter also at Greven (where the Minimoa was) so that both it and the Minimoa can appear in their full beauty at next year's Oldtimer International Rally at Lasham in England.

## A Goppingen 1 "Wolf"

This has now arrived at the Welzhofer Collection at Gunzburg, Bavaria, from Jan Scott in America. As this Wolf was built in the USA in 1941, it has modified, clipped, wing tips and simplified nose. It is rumoured that these will be changed to original..... but first, it must be denazified. Both it and the above mentioned Ju 52 have arrived from America in full Nazi markings!

## Rhönadler 35

Klaus Heyn was again delayed by too cold weather for gluing, but it is believed that its wings are well advanced. The rest of the machine is ready.

## HUNGARIAN NEWS

We have heard that both Vöcsök and Cimborá will take part in the International Rally at Amlikon. The P.O.2 Russian biplane, which was restored last year, will also be there. Among the Hungarian team will be Eva Simo Avarosy, who directed our International Rally in Hungary, and our old friends Imre Mitter and Laszlo Takacs.

Production of vintage gliders in Hungary depends on whether various organisations building and restoring them can obtain aircraft approved materials, which usually require hard currency to enable them to be bought in the West. Aircraft approved wood, fabric and glue does not now exist any more in Hungary. The Agricultural Aviation has been able to sponsor production of the Vöcsök, Cimborá and restoration of the P.O.2 biplane, as the firm imports and uses materials for repairing their own aircraft.

One of the Flying Clubs of the Air Branch of the Home Guard Assn. owns the restored Junius 18. These clubs have almost no opportunity to earn hard currency. The recently formed 70 member strong veteran pilots' gliding club belongs to this organisation. As at present no one can agree on a medical fitness standard for the old pilots (the standards which were proposed last year have not been approved as yet), they were in danger of being unable to fly. However, the leaders of the Air Branch of the Home Guard Assn. have allocated a Gobe two-seater to them, so that they can fly with instructors. In Jozsef Szepesi, an ex fighter Commander, the Air Branch of the Home Guard Assn. has a good leader.

The firm of AEROFA (Aerowood) is fighting for its very existence. This depends on whether production of its seven man workforce can earn enough hard currency to pay for aircraft approved materials in the West to assure their continued production of aircraft. Therefore, they are constructing ultralight biplanes called Aero Famadars (Aero Wood Birds) for sale to the Austrians. They are also working on Attila Ziermann's Szuper Futar and trailer, as well as on a Siraly (pronounced Shirai) Swallow, which was Hungary's top class competition sailplane in 1958, and on some old engines, for the museum. So at present AEROFA is far too busy trying to make itself economic to build or restore old gliders for the Hungarian Oldtimer Club.

No criterion has yet been fixed for the airworthiness of old gliders. It seems that the firms which originally built them gave them "lives" and would not be responsible for their airworthiness after the "lives" had been exceeded. Nobody can be found to make a decision to prolong their lives.

Many firms and club workshops have been restoring old gliders for static exhibition in the new museum, which will also display some interesting aeroplanes such as Brandenburg and Sokol.

Meanwhile, the AEROFA firm desperately needs Western customers and will even organise the fetching of an aircraft for restoration or repair from up to 1,500 kms away. Its Foreign Trade Agent's address is:- TECNICA KULKERESKEDELMI VALLALAT, P.F. 125, 1475 Budapest, Hungary.

The greatest encouragement for the Hungarian Vintage Gliding Club is the acceptance by the Hungarian authorities to organise an International Vintage Gliding Rally, to mark the 60th Anniversary of Hungarian Gliding, in 1989. It is sure that this will give stimulus to further production of Hungarian vintage gliders... such as an M.22 or Szello or Tucsök. As already stated, the Vöcsök and Cimborá replicas belong to the Agricultural Aviation, which built them. Therefore, only members of this organisation can fly them. Istvan Killian left this organisation last year but had special permission to fly the Cimborá at Terlet. We hope that special permission will be given to other members of the team, to fly them, when they are at Amlikon.

The AEROFA firm would dearly like to supply the Hungarian VGC with old gliders but must first earn hard currency to do so.

Clearly present regulations make it far more possible to grant C of A's to replicas of old gliders, rather than to restored originals. Attila's Szuper Futar will be submitted for a Swiss C of A when it is finished. It is a great step forward that replicas of old gliders can be flown. Meanwhile, we hope that the Junius 18 and P.O.2 biplane, which are restored originals, will have many more hours of life. If only the requirements for old gliders' airworthiness, and the medical standards necessary for old pilots, can be resolved, then it is sure that the Hungarian Old-timer movement will have a healthy future.

Meanwhile, we in the West can help by sending the firm AEROFA our restorations and repairs so that it can earn hard currency to buy aircraft materials to continue work on old aircraft, although our National Inspectors will have to clear the work.

We urge our Hungarian friends not to give up their struggle and to remember that we will do all we can to help them.

#### IN AUSTRIA

Austrian representatives at the C.I.V.V. meeting in Paris reported that requirements for old gliders' airworthiness are even stricter this year in their country. This apparently is related to the severe turbulence that can be met with in their mountains. One of the Austrian delegates related how he had done over 700 km distance flights on three consecutive days. Clearly, old gliders should not be subjected to such high speed flying in turbulent conditions, but why cannot their max. rough air permissible speeds be limited, as would be done here in Britain? The Swiss are flying vintage gliders in their mountains, which must also have turbulent areas. Why cannot the Austrians follow their lead?

#### FRENCH NEWS

We are glad to report that the AIR 102, which was damaged at Terlet last summer, is now out of the workshop of the G.P.P.A. at Angers and must therefore be repaired. Into its place in the workshop has gone the Weihe of the Musée de L'Air. The museum has entrusted this aircraft to the G.P.P.A. for restoration. An inspection of the fuselage has revealed that this is sound. As the museum already has a Weihe on display, we hope that this one will be allowed to be flown. Some years ago it was grounded "à cause d'une Colle très fragile" (because of very fragile glue) as were all the remainder of the 450 Kaurite glued sailplanes removed from Germany in 1945. These were all burnt by the clubs because of their taking up hangar space, except for 2 Mü 13d, a Rhönbussard and perhaps a Weihe/Milan?, and S.18 rescued by Francois Ragot.

Thus, this Weihe at Angers may be going to be the last pre 1945 German built sailplane to be flown in France. We imagine that the authorities, who have had a war against Kaurite glued sailplanes, every five years since 1945, will find this Weihe rather small fry after dealing with the others. However, we can well believe that they will have a harder time getting rid of it owing to the present initiative in restoring old gliders in France. Quite clearly, in an emergency the Musée de L'Air or our friends at Angers can give it sanctuary. Other Milans (French-built Weihe's from German parts) the survivors of 29 built in 1950, must still be in France. The G.P.P.A. has also its AV.36 (F-CBRK) flying.

#### The Birth of A.S.P. A.C.

The exact significance of the above letters has so far escaped us, but it is quite clearly the creation of our member Yves Soudit to save the old gliders of Charolais. Thus, this is a third organisation to save old gliders in France besides the G.P.P.A. and "Les Aéroplanes". Others may also exist but all are "spoken for" by Dédale, which continues to be the inspiration for the movement in France. A.S.P.A.C. has in its fleet the well known C.25S F-CRIN, two Nord 2000's (Olympia Meises) F-CBFR and F-CAYQ, which one can see at Bourges, and the C.800 F-CAJK No.370, being repaired. One has great confidence in Yves and his team for the dynamic spirit which they have created.

The Nord 2000's of Charolais are not of pure race!

This scandalous revelation was made, not by a member of a rival association, as one might imagine, nor as a wild rumour, but by A.S.P.A.C. itself. Having used their tired eyes to scan through the archives for documents, the log books, etc., etc., the flagging team of Charolais, around Yves Soudit, have had to reveal that "it is true, our Nord 2000's are composed of parts and pieces"! CAYQ (No.78) has certainly the fuselage of No.78 but its tailplane and elevator are from No.11 (F-CAGF), the wings of No.88 (F-CCYH)... as for the canopy...? Also, F-CAYD, stopped flying in 1971, has come to the rescue of A.S.P.A.C. It is No.35 that has its fuselage, but one wing comes from No.30 (F-CAUN), the other from No.10 (F-CAGE) and its elevator from No.100 (F-?). Among these hybrids, No.13 is a little more original, but has a wing possibly from No.79! These revelations reinforce the belief that N.200's have been cannibalised. We wonder what other glider types have suffered from this perversion? The VGC says "It is clear that N.2000's were built so well that parts can be interchanged without problems." Yves Soudit has found wing and fuselage fittings as new, and moulds to form the rear fuselage plywood, and other parts for N.2000's.

Other French News

N.2000 F-CAOP, Philippe Comte, is for sale at Cognac. Major inspection is now due. Price 7,000 fr.

C.800 - airworthy in 1984, with trailer and the towing vehicle (which usually tows it), 22,000 fr.

Daniel Chateau is looking for an AIR 100 or AIR 102.

Jean Maurice Keller is preparing a technical article on the AIR 100, and wishes to receive all documentation on the type.

Jacky Arnoux is searching for a Breguet 901 or an AIR 102. His address is: 2 rue du Berba, 88000 Epinal, France.

Frank Descatoire offers an AIR 100 (F-CDZF) damaged for repair.

Dom Gats is searching for the "World Sailplanes 1938" edited by Aero Reve Suisse.

Richard Ferriere is trying to produce a technical article on all the AVIA gliders and wishes to have all documents concerning them. Address: 26 ave X. Mornier, 25,000 Besancon.

Jean Daniel Goujon is looking for a 3 view plan of the Cumulus for a modeller.

Germany,

Yves Soudit is looking for parts for all his N.2000's, i.e. Venturi, tube and masts, compass, Badin ASI 0-120 kph. Old vario vacuum bottles.

Laurent Thomas is searching for a Breguet 901's canopy. Theirs, flown from the Aeroclub de L'Est, became damaged in thermal turbulence. Address: 5 rue des Vignes Benestroff, 67670 Albestroff, France.

Dom Gats wishes to obtain documentation for the Arsenal 4-111 on which he has been working for months.

Daniel Chateau is looking for documents concerning the Peyret tandem wing glider (winner 1922 Itford Hill Meeting) which broke the world duration record, ravishing the German monopoly of such records: Aéroplanes, 4 Allée Vivaldi, 44800 St. Herb-lain, France.

Phil Gourges can obtain plastic models of Polish sailplanes 1/72nd scale. He wishes to sell them or exchange them for plastic model aeroplanes. Injected plastic, transparent parts, markings, etc. Residence Formanoir, apt 530/T5 33600 Pessac, France.

The above information was gleaned from the Dédale Newsletter which was received at the beginning of June. It contains an excellent report of the French Gliding Meeting at Combegrasse in 1922.

## AMERICAN NEWS

The Horten 9 semiscale lookalike has successfully flown under Wankel type power at Reno. Both Reimar Horten and Rudi Opitz have shown great interest in the aircraft. However, Reimar is unfortunately not well through heart trouble and is unlikely to be able to leave Argentina to see it.

The Orlik is still being flown at Phoenix Arizona and is in Polish colours of red and white. Its owner, John Serafim, is a Polish expatriate. It is the last pre-1940 Polish sailplane that is still flying, having been brought to America as a Polish exhibit in the 1939 World Fair. It is possible to imagine that it might have been related to the Mucha and Bocian. The type was also in production in Yugoslavia and the VGC is currently trying to discover whether drawings for it might still be there.

Dale Busque is still slowly repairing the H.28 and has most of its drawings. However, he still needs some of the most important ones. Dale also owns the famous pre-war US Zanoia sailplane.

### American Minimoa

There will soon be four Minimoas in America. One is owned, airworthy, by Jan Scott at his air park near Lovettsville, Virginia. John Karlowich of Atlanta, Georgia, will soon possess the John Coxon Minimoa, which is also airworthy. Another, which also came from England (Philip Brown) in 1940, is currently owned by the airline pilot, Joe Jackson, in New York. He has bought a trailer for it from Jan Scott and is believed to be undertaking its restoration. The fourth Minimoa, registered N 16923, is exhibited in the National Soaring Museum at Harris Hill, New York State. This was a famous Minimoa, which was flown by American gliding pioneers in the 1930's.

A fifth Minimoa is exhibited by the Santiago Museum in Chile. This had been delivered in 1936 aboard the Graf Zeppelin Airship to a German in Argentina. It has no landing wheel fitted, but otherwise seems to be a standard production Minimoa.

There will soon be the same number of Minimoas in the USA as there are in Europe. Three of these are owned by airline pilots in America.

Minimoas airworthy in Europe are:- One in Switzerland - HB-225  
One at Münster - D-1163

Minimoas unairworthy in Europe are:- One at Göppingen Betzgenriet - OE-0230  
One at London GC - BGA 1639

One is being constructed by Bob Persyn in Holland.

## JAPAN STARTS

Our Japanese member, T. Uchibayashi, writes that he has taken delivery of a "TAKA-7 KIRIGAMINE" for overhaul. This is the only "TAKA 7" in Japan and was flown until five years ago, since when it has been hangared. Its registration is JA-2011. His beautiful photographs, alas in colour and unprintable in black and white, reveal that the "TAKA" is without fabric. He will send photos later when it is restored. He writes:- "We regret that all sailplanes were missing after World War 2, so that there are no more sailplanes which we can call vintage." The "TAKA 7 KIRIGAMINE" was a re-designed Grunau Baby which was constructed after World War 2.

We remember Wolf Hirth's influence in Japan during the 1930's and that the two prototype Minimoas of 1935 and a Wolf certainly influenced sailplane design there. We are proud to have T. Uchibayashi among our members.

## SWITZERLAND

The Moswey 3 HB-374, which attended our first two International Rallies in 1973 and 1974 at Husbands Bosworth and the Wasserkuppe, owned by Willi Bischof, has now been sold to the Oldtimer Club, Schanis.

We are very sad to hear that the veteran Swiss sailplane builder and repairer, R. Sägesser, has lost his son and wishes to take no part in aviation any more. He was builder of the first Elfes, and many were the alpine soaring camps that he visited with his son, just at the right time to repair damaged sailplanes. We hope that he will recover, for vintage gliding needs such people.

Karl Suter is unfortunately unable to continue flying for medical reasons. Many of us will remember him and his Spalinger S.16 taking part in our Thun International Rally where we came to know this most original Swiss gliding character. He hopes to sell his S.16 in Switzerland. In his own country, he is almost legendary among sailplane pilots, who have given him the name "Rigi" Suter. Between the Vierwaldstätter and Zuger Lake, lies the Rigi mountain, 1.797 m, which can be ascended by means of a rack railway. Karl reasoned that the railway would be an ideal means to transport his glider to the summit, and that is exactly what he did. All that was necessary was to convert a railway waggon to take a sailplane. When at the top, his gull winged aircraft was assembled and accorded a bungee launch. From then on, the trip by rack railway to the top of the Rigi and a glide descent was a favourite trick in his aviation repertoire, even although it took a full day's labour to earn one flight from summit to valley floor. He always found willing hands to help, even in winter. That was in the fifties. His S.16, which he discovered and restored shortly after the war, was in terrible condition, somewhere in Switzerland. Its restoration took an enormount amount of time and money, which took years to pay off bit by bit. However, it is still in the best of health. The designer of the S series is Jakob Spalinger, who was born in 1898 in Winterthur. The first S.16 was sold in 1935.

#### FRANCE

We understand that great efforts have been made to repair the AIR 102, which was damaged at Terlet, in time to come to Switzerland. We believe that such sailplanes as AIR 100's and 102's are beginning to have financial value in France. There is also interest in recovering the AVIA 40P which is at Perrenporth and needs restoration.

#### EGYPT

##### Moisture Content in wood

Four years ago at Wycombe Air Park, an Egyptian was met who declared that he had just grounded all the Bocians in Cairo as their wood had dried out. This year, another Egyptian was met at the March C.I.V.V. meeting in Paris who declared that all these Bocians were still being flown and that they "just take them to Alexandria by the seaside to recover their moisture content", and that Egypt has almost no other sailplanes except Bocians. This once again boosts our faith in wooden sailplanes. We had heard that the rapid changing of moisture content in wood would bring about its cellulose collapse causing brittleness. If the Bocians are being taken backwards and forwards from dry to humid locations and they have shown no signs of collapse, then they are quite some glider and we need never again fear for our wooden structures. However, we still urge our members not to paint their gliders dark colours or even black as these get very hot on the ground in the sun.

#### DUTCH NEWS

##### The "Vereniging Historische Zweefvliegtuigen" Zaltbommel April 2nd 1985

It is a great pleasure to inform you that we have formed in the Netherlands the first national club which has, as objective, the establishing, supporting and developing of vintage glider movements. The first board, elected by members of the club, are the following:-

Jan van Beugen - Chairman  
Jan Forster - Vice Chairman  
Nell Dijkstra - Secretary/Treasurer  
Jan Vermeer - Technica Affairs  
Martin Louwinger - Archivist

Since a vintage glider club with these objectives has not, until now, existed in Holland, many Dutch fans are members of the Vintage Glider Club of Great Britain. For this... and for giving us a good example, we owe the VGC a lot. We certainly will consider them to be the Mother of International Vintage Gliding Movements and will encourage our own Dutch members to continue their subscriptions to the VGC News.

But there is more. Our club will facilitate and maintain communication with all vintage gliding clubs, wherever they are in the world. Another thing is that we have to cope with national regulations from our own Aviation Authority to keep our vintage gliders flying. These considerations have resulted in the forming of the "Vintage Glider Club Netherlands".

We are looking forward to a long and extensive relationship with your organisation.  
Jan van Beugen - Chairman

We are pleased that the above club has been formed, and are convinced that such clubs in individual countries are the proper way of fostering National Vintage Gliding Movements.

On Tuesday, 7th May, the T.31 (WT-871) BGA 3149 left Wycombe Air Park aerotowed by a Cessna 172 for Holland in far from perfect weather conditions. The new owner is Wim Daams, the Dutch aerobatic power pilot, who wishes to try gliding for the first time. The pilot of the T.31 was our member, Friedrich Wevers, who has a collection of vintage gliders in Holland. While Wim Daams has vintage aeroplanes, which include a Swedish Bucker Bestmann, Friedrich has a Hungarian Ifjusag ("Youth") all metal two-seater, an Austrian Grunau Baby 2b, A-Spats and Specht and an Mg 19, which has the wings of both a and b versions, coming from Austria soon. (This is the Mg 19 which held the Austrian records.)

The aerotow left Wycombe Air Park at 5.00 p.m. in a strong crosswind, turbulence and poor visibility. The Cessna had to be headed 30 degrees into wind off course to maintain track to Southend. They were seen going sideways over Watford! One hour 45 mins. later, Southend was achieved. During the next day, the Channel Crossing was undertaken in one hour 5 mins. at 1,500 ft.... to Calais, where the train was grounded through worsening weather. It is not recorded whether the French thought that it was part of the VE Day Celebration! Both pilots had to return to Holland by Cessna 172 to await better weather, while the T.31 was tied down outside at Calais. We hope now that the first T.31 has arrived in Holland.

Instead of buying a T.21b Raymond van Loosbroek, Neale Lee and Dick Ottewanger have decided to buy the semi-repaired Slingsby SKY, BGA 691-to PH-232-to BGA 1073. This was the SKY used by Philip Wills to win the World Gliding Championships in 1952 in Spain, and, from the registrations, it can be seen that it has already been in Holland. The SKY had a bad accident in 1966 and was being repaired by a syndicate of three people, who have dispersed. There remains the mating of the wings to the fuselage and fabric covering the structure.

Ph-232 was in Holland from 1956-1962 and was spun in at Haverford West in SW Wales. Raymond van Loosbroek has sent a plea for Aircraft Handbook, Maintenance Handbook Maintenance Scheme and Schedule, a set of drawings, list of mandatory manufacturers modifications with technical details. We cannot understand how all these things can be necessary when the type is already known in Holland and has flown there. Are memories so short, and where are all the documents that must have been there before?

From Planeur we have gleaned the following information:

"New" old gliders to fly in 1984 were:-

PH-194	Prefect...	built in 1951	-	Owner	Bob Persyn
PH-196	Prefect...	" " "	-	"	B.C. Karer
PH-222	Skylark 2	" " 1955	-	"	S.J. Vermeer

PH-227 .. Skylark 2 and PH-247 - Rhonlerche have now been sold by their owners into gliding clubs.

### The Dutch Oldtimer Fleet

<u>Type</u>	<u>Club 83</u>	<u>Private 83</u>	<u>Club 84</u>	<u>Private 84</u>	<u>Total</u>
Goevier	2	3	2	3	5
Grunau Baby 2A	-	2	-	2	2
Grunau Baby 2N	1	2	1	2	3
Rhönlerche	11	4	11	4	15
Sagitta 013		5		4	4
SIE 3		5		5	5
Skylark 2		3		4	4
Prefect		3		5	5

Total is 43 aircraft

It seems that these will soon be joined by a Fokker Olympia, SG.38 and a SKY, and possibly ex ATC T.31's, T.21's and Grasshoppers.

Above all, it seems that the Dutch Oldtimer Movement has a very healthy development.

### A REMEMBRANCE

#### Martin Schempp - A German-American flying career

Modest in life - Modest in death. He never boasted. He always behaved naturally and as someone well into his subject. Happy people were always there, for them he worked, and for them he was not only the chief but also their father in their labours. From this person must we take our leave... not however from his people or from the fruits of his long sought after labours. We are talking of Martin Schempp, the founder of the second oldest glider firm in the world, who, on 9th July, 1984, died in peace after a long, serious, illness. He was not able to experience the 50th Jubilee of the Schempp-Hirth firm on 4th January 1985.

The story of Schempp-Hirth began in the USA. In 1926 the metallurgist, Martin Schempp emigrated to the USA. Enthusiasm for the exploit of Charles Lindbergh crossing the Atlantic brought him into contact with flying. In 1928 he returned to Germany to learn flying. He started work with Raab-Katzenstein in Kassel. The visit to the Wasserkuppe, the meeting at Vauville, France, and the Klemm Flying School at Böblingen brought him together with Wolf Hirth and increased his progress. In 1930 he founded in the USA, with Gus Haller and the support of Wolf Hirth, the Haller-Hirth Sailplane Co. in Pittsburgh. The building of German gliders, Zoegling, Prüfling and Professor from parts imported from Germany, allowed basic gliding training from first hops to cross country flying. Spectacular flights and staggering performances, by Wolf Hirth in 1930 and 1931, first made American gliding respectable and famous. Martin Schempp, above all known for his development work, is known as one of the fathers of American gliding and took an important part in the organisation of gliding clubs in the universities and the Soaring Society of America (the SSA). Not least has the American Gliding Movement him to thank for its survival through the hard times of the early 1930's.

In 1934 Wolf Hirth brought Martin Schempp back to Germany to be gliding instructor at the Reichssegelflugschule Hornberg. However, soon he made clear his wish to again build sailplanes. On 4th January 1935, with help from Wolf Hirth, the firm Sportflugzeugbau Martin Schempp was founded at Göppingen. The famous (Gö=Göppingen) family of sailplanes was started with the Gö 1 "Wolf". The tandem two-seater Gö 2, followed quickly by the famous gull-winged Minimoa, were produced. The latter still amazes people today with its bird-like swept back leading edged wings. In 1938 the firm was re-named Sportflugzeugbau Schempp-Hirth. Wolf Hirth had now an official position in the firm. At this time Ulrich and Wolfgang Hütter were developing the Gö 4, the two-seater with side-by-side seating. Ulrich Hütter was also busy with the Hi 20 Motorglider Mose and sporting aeroplanes with car engines as powerplants. The Hütter H.17 was placed in production as the Gö 5. In early 1938 was the 100th "Wolf" built and, on the 30th June 1938, the 100th Minimoa was delivered. This last

event took place in Kircheim Teck, in the same workshops where today's Ventus, Nimbus and Discus are finished. Space in Göppingen was too limited, and the former furniture factory at Kreben Street 25 came up for offer. It was also near the airfield (Nabern, Dettingen), and the move was made in the summer of 1938. Wartime brought few orders for gliders. In spite of this, between 1.9.39 and 1943, 71 Goeviers were finished - but there were other contributions to the German aircraft industry, i.e. tailplanes for the ME 321 (Gigant) and ME 109's, sample wings for the ME 163 (Komets) and tasks for the quickly growing "Experimental Werk Wolf Hirth", Nabern.

After the war, from May until October 1945, Martin Schempp was Mayor of Kircheim and did, in this function, much for the normalisation of life. Furniture, model kits, wooden artificial legs and feet, interiors for radio studios, and many other things not to do with aircraft, were constructed in Kircheim. A great number of locomotives and aircraft mock-ups led to the construction of aircraft. The gondola and tailplane surfaces for the airship "Trumpf" were built under the direction of Alfred Vogt (known for designing the Lo 100 and Lo 150's) during 1955/56. The light aeroplane "Himmelheber", the Schempp-Hirth GS6A "Milan", the 15m glider Matteson M-I and the circular wing aircraft Binder B-24, were built as prototypes only. A small number of Piel CP 301 "Emeraudes" and "Smaragd", K.8's - kits, and control surfaces for the Do 27, were witness to the beginning of the 1960's.

The new era began with an order from Eugen Hänle's firm Glasflugel for pairs of wings for the Wolfgang Hütter designed H 301 "Libelle" and thus the renewed climb to today's high standard in the world. The licence for the series production of the OSTIV prize winning Standard Austria was the first mass production of a glider since 1945 and tied with the production of the excellent pre-war machines. Klaus Holighaus improved it with the SHK in 1965 and the first Cirrus was already flying in 1967, an open class glass fibre sailplane. Before his retirement in 1972, the Standard Cirrus and Nimbus were brought out. It was now clear that Klaus Holighaus had taken over direction of the Schempp-Hirth firm. Martin Schempp could only acknowledge the further success of the firm since that time. Since 1977, Klaus Holighaus has led today's Segelflugzeugbau Hirth GmbH as owner. Martin Schempp spent this time, before his serious illness very withdrawn, missing the first flight of new aircraft types, as he never would have when he was young.

The evaluation of his achievement, in the fields of labour relations, for flying, and in the design of original aircraft, can only be incomplete and superficial here. During the war and post war periods, he used to lead his men from the front, when they had difficult tasks. Because of this, many of his men still think of him as their chief and comrade. Perhaps, this gave the firm the ability to survive hard times. Martin Schempp can be considered as the main reason why the firm still has the reputation for producing the best sailplanes.

With the passing of Martin Schempp, we have lost one of the last great pioneers of sailplane mass production.

By Peter Selinger.

Translated from German by C. Wills

---

#### CAPTAINS TO PHOTOGRAPHS

Top to bottom - left to right

1. Martin Schempp when he was young.
2. Martin Schempp, when he was older.
3. Left to right - Otto Bräutigam, 4th 1938 Rhon Contest, flying a Weihe. (Killed with Bernard Flinsch while testing an ME 321 "Gigant" at Leipheim in 1941.) - Wolf Hirth - Martin Schempp.

We are indebted to our German friend, Lothar Döge for sending us these fine photographs. Also, we thank Erika and Josef Kurz and Karl Vey for helping to obtain them.

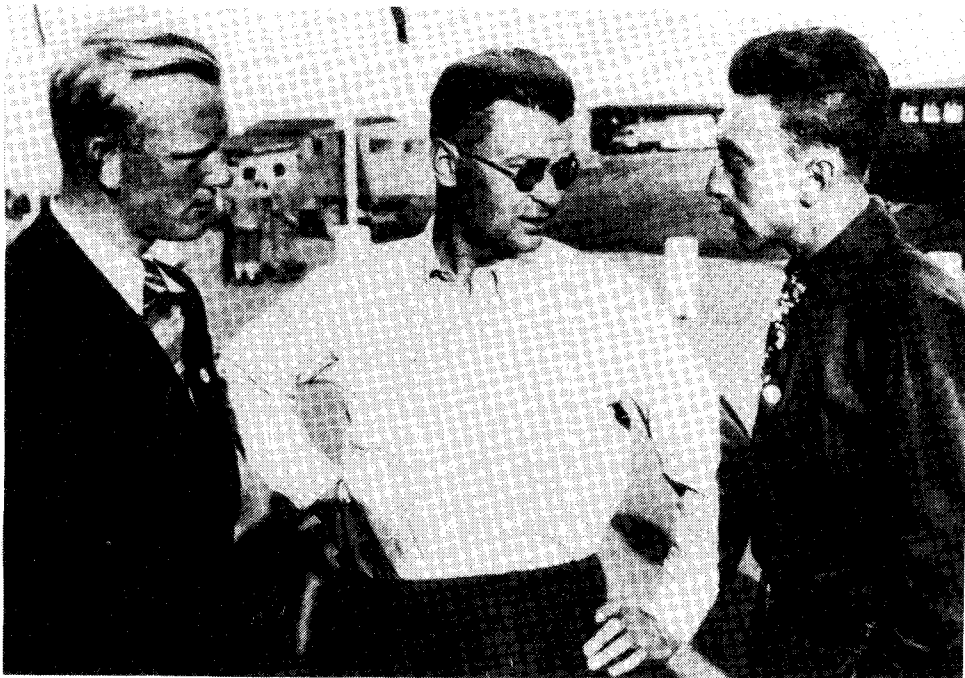



# Sportflugzeugbau Schempp-Hirth

O. H. G.

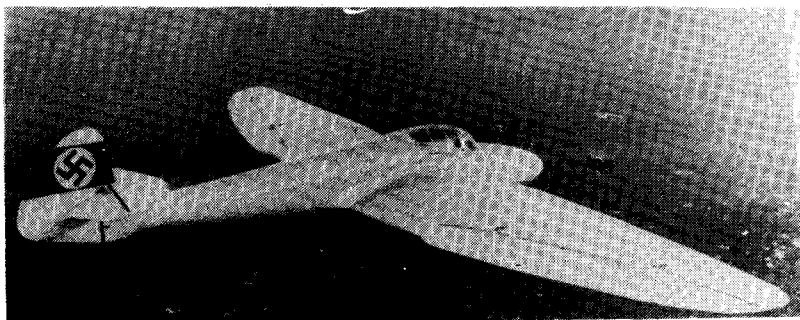
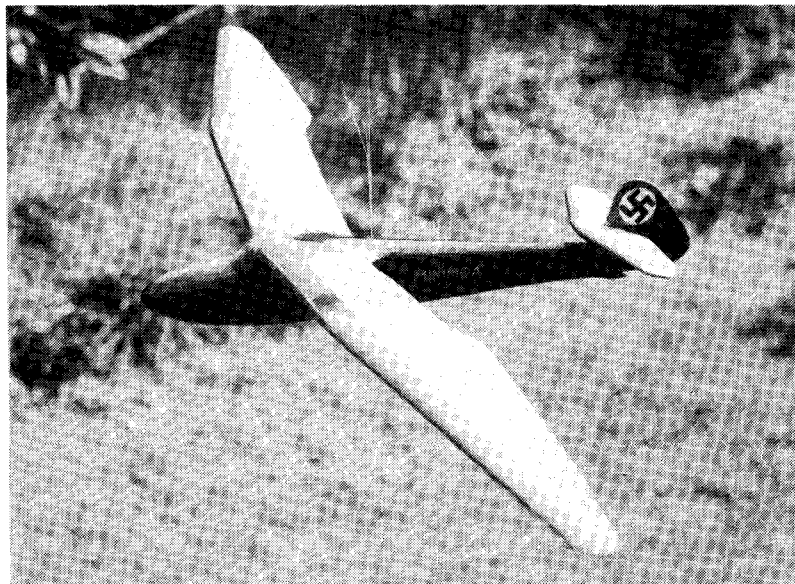
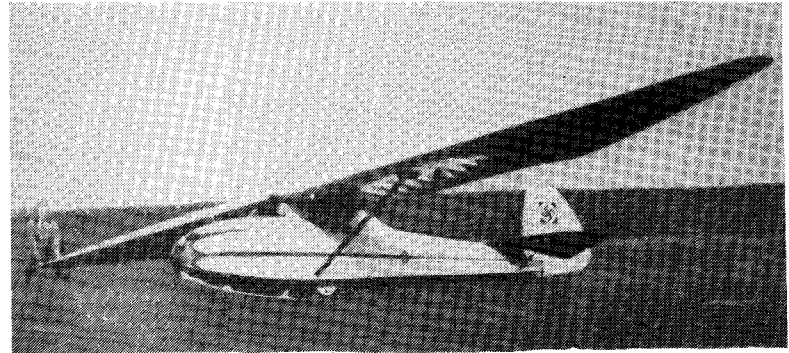

## CAPTIONS TO PHOTOGRAPHS

Top to bottom - Left to right

### The Göppingen family

1. Göppingen 1 "Wolf" 1935 - Over 100 built
2. Göppingen 2 two-seater 1935
3. Göppingen 3 "Minimoa" 1935 - 110 built (Joan Price's model of a 1935 prototype)
4. Göppingen 4 "Goevier" 1937 - Over 130 built
5. Göppingen 5 Hütter H.17 1936, but it was designed earlier in Austria in 1934.

Other Göppingen designs such as the Gö 6 2-seater Minimoa, Gö 7 2-seater light aeroplane, Gö 8 test model for Do 214 flying boat have been left out.

---

As the name of the firm Schempp-Hirth is known widely throughout the gliding world, we thought that it is appropriate, as a remembrance of Martin Schempp has already been included in this VGC News, to write also about Wolf Hirth.

### Wolf Hirth - A Life Devoted to Sporting Flying - by Peter F. Selinger

On 25th July 1984, the death of Wolf Hirth was remembered for the 25th time. No one has achieved so much for sporting aviation as him. Motor gliding, that made cross country flying available at cheap cost, was his idea. He filled young pilots throughout the world with enthusiasm for gliding. Even today, sailplanes bearing the name Schempp Hirth go out to the entire world. They are flown by many races, regardless of politics. What is today taken for granted as equipment for flying, performance or experience, was discovered by him and made known, so that others could enjoy it as well. The flights to Iceland with the 20hp Klemm, and in the Bucker biplane, to South Africa, served also this goal and were also masterful flying achievements. On the other hand, Wolf Hirth was always ready for some fun. One thinks of the film when he aerobatted a Grunau 9 "Skull Splitter" with a wingmounted camera, demonstrating looping, turning and not under control, hanging notices to this effect, on the side of the aircraft, and allowing the stick to descend to the ground on a small parachute. Of course, he had with him a second stick, which he fitted after a few seconds of trimmed straight flight. For the first time, a water ballast tank was built into the Grunau 7 "Moazagotl", in order to increase wingloading and, thereby, its performance for cross country flying.

His capacity to hold an audience and to create enthusiasm predestined him for gliding journeys, should they be from his own inspiration, as it was to the USA or to Japan, which was negotiated by Ernst Udet, or within the framework of the German gliding expedition to South America. After the war, this gift was of much assistance. With the help of glider pilots from the victorious lands, he was able to obtain permission for gliding to re-start in Germany. That, in 1950, he was chosen to be first post-war President of the German Aero Club, was perhaps an omen for this, and was for him a duty as part of his inner compulsion to serve and to help gliding. An expression of his missionary activity was also his 13 books and writings, besides many newspaper articles that he wrote during the 1930's.

His greatest legacy was the invention of the motor glider, the H.20, which had a retractable power unit. The built-in motor was for take offs and crossing thermal-less areas. With retracted engine, it was no different from a sailplane. Today's world distance record for motor gliders of over 1000 kms is impressive. As the number of those wishing to learn to fly annually diminishes, it is still possible for them to get to know Wolf Hirth by flying in a motor glider.

Peter F. Selinger

Translated by C. Wills.

Wolf Hirth - a Life for Sporting Aviation - Peter F. Selinger

Table of Wolf Hirth's Life

- 1900 - Born on 28th February in Stuttgart
- 1913 - Founder of a Model Aeroplane Club.
- 1916 - First flying experiments at Bissingen.
- 1919 - Membership No.3 of the Flight Technical Assn., Stuttgart.
- 1920 - He built, with Paul Brenner, a Hang Glider to take part in the Rhön Contest. He starts studying in the Technical High School in Munich.
- 1921 - The building and flying of the Harth Messerschmitt aircraft S.10.
- 1922 - He flew the S.10 and took part in the 1922 Rhön Contest.
- 1923 - The construction of the S.13. Test pilot for Harth-Messerschmitt. Gliding Licence No.44. Crashed at the Rhön on 11.4.23 (5 months in hospital).
- 1924 - 4. Rhön Contest flying "Roter Teufel" (Red Devil) and "Dja vlar anama"; Motorcycle Race victory on Hellmuth Hirth type (his brother).
- 1925 - Amputation of left thigh following a motorcycle accident. Founded the Akaflieg Stuttgart while in a hospital bed.
- 1926 - Motorcycle Races (Avus - 1st place). Assistant at the DVL and Power-flying Licence.
- 1927 - Started studying at the Technical High School, Stuttgart.
- 1928 - 1.3.28 Diploma Engineer. Gliding Contest at Vauville, France. He won all 41 prizes. Competed in the 9th Rhön Contest with the "Württemberg" sailplane. The foundation of 60 flying and work groups in Württemberg as technical adviser for the Württemberg Air Travel Soc.
- 1929 - 10. Rhön Contest with the "Lore" sailplane. The Hindenburg Trophy for powered flying. German Sport Flyers Badge in Gold No.7.
- 1930 - Married Clara Wagner. Iceland flight (8 hrs. 30 mins. over water with Klemm 25!). 1st Prize in the first Elmira Gliding Contest in the USA. First car launches.
- 1931 - Glider flight over New York after a bungee launch from the side of the Hudson River. Introduction of winch launches (Wander Circus). 2nd place in the Deutschlandflug with Klemm. Silver C No.1. Competed in 12th Rhön Contest with the "Musterle" sailplane.
- 1932 - Round Europe flight with Klemm 32 aeroplane. Competed in 12th Rhön Contest with the "Musterle". Hindenburg Trophy for gliding.
- 1933 - Construction of the "Moazagotl". Foundation and direction of the Hornberg Gliding School. University Lecturer at the Technical High School Stuttgart. Took part in the 14th Rhön Contest and the Deutschlandflug (powered flying).
- 1934 - World record with the "Moazagotl" at the 15th Rhön Contest (352 kms). The Round Europe Flight (Rundflug). The South American German Soaring Expedition.
- 1935 - Foundation of today's Schempp Hirth glider factory, together with Martin Schempp, in Göppingen. He was for three months a gliding instructor in Japan. First flight of the Gö 3 "Minimoa".
- 1936 - Ring of Honour of the VDI. Bad crash with a Grunau Baby in Budapest.
- 1938 - He flew solo a Bucker 131D "Jungmann" to South Africa.
- 1939 - Foundation of the Wolf Hirth Experimental Factory in Nabern/Teck.
- 1940 - Flying Instructor on troop carrying gliders in East Prussia.
- 1941 - Until the end of the war. Construction of DFS "Habicht" aerobatic sailplanes. Aircraft development and construction of wooden tailplanes for Messerschmitt aircraft.
- 1950 - Foundation of the German Aero Club in Gersfeld/Rhön, choice as President. Founding also the BWLV.
- 1951 - Chosen again as President of the German Aero Club. First flight of the Gö 4-111. First flight at the Hahnweide, near Kirchheim/Teck.
- 1954 - Chosen as Honorary President of the German Aero Club. Gliding lecture tours.
- 1958 - The FAI Lilienthal Medal.
- 1959 - Fatal accident on final approach from 80 metres height at Nabern. Buried on the 29th July in the Waldfriedhof (Woods Cemetery) in Stuttgart.

## BOOKS

The book "NURFLUGEL" by Dr. Reimar Horten and Peter Selinger has now completely sold out its second edition. A third reprint is now being considered. It seems that the Weishaupt Verlag in Austria and Stuttgart's Motorbuch Verlag, who refused to print it on account of their thinking that it would not sell, both seriously under-estimated its popularity.

"The World's Vintage Sailplanes 1909-1945" from Martin Simons - reprinted from "Bungee Cord"

"In September 1980 a contract was made between myself and Kookaburra Technical Publications Pty Ltd., of Victoria, Australia, for publication of this work. The publication has not taken place. Currently, litigation is in progress concerning the title and copyright in all the materials delivered by me to Kookaburra Technical Publications. In spite of repeated demands, none of this material has been returned to me. More than 300 photographs and colour transparencies, many of them irreplaceable and rare, over 80 detailed scale drawings done by me, and negative copies of those drawings, together with text and tabulated technical data, colour samples, three of my designs for radio controlled model sailplanes and more, are involved. My claim is that, at all material times, title in these materials vests in me, or in those persons and agencies from whom photographs were borrowed or hired, and only I am entitled to offer any of these items for publication.

I am concerned in case any of my material, or that loaned to me for use in the book, should be published without my permission. This would expose anyone involved, even if acting in good faith, to the likelihood of action for breach of copyright. I have no desire whatever to inhibit publication of information about old time sailplanes or of background information concerning them. Quite contrary! Nevertheless, it would be most wise for any items about which there is the slightest doubt, to be referred to me in advance. As the dates in the title of the book indicate, only sailplanes and gliders designed between 1909 and 1945, inclusive, are involved, but of course many of that era were still being built in post WW 2 years, and some of these are still flying. Rest assured that any enquiries to me will be dealt with fairly and promptly."

Martin Simons, Stepney, South Australia.

Monogram Close-Up 12 - Horten 229 - Illustrated with photographs, drawings and paintings, by David Myhra in English.

This is an American publication, using information gathered from interviews with the Horten brothers and also photographs from Reimar Horten's collection. For the first time is revealed the story on how the Horten Bros. were able to continue their all wing aircraft research and production, unofficially, during the war, and how construction techniques learnt on the Wasserkuppe for light-weight sailplanes were converted for production of a 9 ton twin jet fighter! It is one more incredible story from the Germany of that time.

Monogram Aviation Publications, 625 Edgbrook Drive, Boylston, Massachusetts 01505, USA. It also can be obtained from the Beaumonts Aviation Bookshop, 656 Holloway Road, London N19 3PD, Tel. 01 272 3630. Price unknown, but should not be too expensive as it has a soft cover.

Soon to come out - Monogram Aviation's publication "The Horten Brothers and their All-Wing Aircraft" also by David Myhra. An American publication in English. This was also compiled from information and photographs gathered from Reimar and Walter Horten. Reimar has said that he likes the book, which complements, but does not compete with, his own book "Nurflügel". It will also be obtainable from the above sources.

"Nurflügel" by Reimar Horten and Peter Selinger. The story of the Horten aircraft from 1933 - 1960. An Austrian publication in German, but has an English text by Jan Scott. Publisher H. Weishaupt, Graz, Austria. Amply illustrated with photographs and drawings. Much technical information and data is included. H. Weishaupt Verlag-Graz and from Beaumonts Aviation Bookshop, as above.

"Uber Sonnige Weiten" (Beyond the Sunlit Horizons) Wasserkuppe History from 1932-1939 by Peter Riedel. Although no copy has yet been seen, it must be about to be published. In German but amply illustrated. Published by Motorbuch Verlag Stuttgart. This is the final book of Peter Riedel Wasserkuppe trilogy. If it is as good as Peter Riedel's first two books of self experienced Wasserkuppe history "Start in den Wind" 1911-1926 and "Vom Hangwind sur Thermik 1927-1932" it will be definitely worth having. These should all be obtainable through the Motorbuch Verlag Stuttgart and through Beaumonts Aviation Bookshop... address and telephone number as above.

Segelflugzeuge, Vom Wolf zum Mini Nimbus by Peter Selinger. Motorbuch Verlag Stuttgart. This describes the production of Schempp Hirth from 1935. In German but amply illustrated with photographs and drawings. A fascinating and wonderful book. This can also be obtained from Beaumonts Aviation Bookshop... as above.

Happy to Fly - An autobiography by Ann Welch. Published by John Murray Price £10.50. Obtainable from most bookshops. A most readable and interesting book. Amply illustrated with photographs and drawings.

#### The World's Vintage Sailplanes 1908-1945

The court case to resolve a legal problem was postponed one month and was to have been held on the 8th May in Adelaide Crown Court. It has now been postponed until 19th August, due to the defendant's Counsel being unfit, medically, to defend the case on the 8th May. It is clear that this book by Martin Simons is getting enough publicity!

#### FOR SALE

RRG Falke 1927 (Slingsby Falcon 1.1931) replica - built 1985. Airworthy with BGA C of A. With closed trailer. Masterpiece of construction. Finished in the old style.

Offers to: Southdown Aero Services, Lasham Airfield, Nr. Basingstoke, Alton, Hants. Tel. 0256 83 359. John Sproule and Ken Fripp hope to sell their creation in Britain or Germany.

Meise (built as a labour of love during the 1950's in Germany). With closed metal trailer, barograph and parachute. With C of A. A magnificent aircraft to fly. £2,500 o.n.o. Thoby Fisher, 36 Worall Road, Bristol, BS8 2UE. Reason for sale - he has bought a Dart.

Nord 2000 Olympia Meise - built 1947. Restored. New trailer. Offers to: S. Fothergill. Tel. Basingstoke (0256) 20123 Ext. 523, or 0253 3243.

Scheibe Specht No.4 light two-seater (223 kgs) trainer. Built 1956 by Akaflieg, Munich. Excellent condition. Complete with instruments. Drawing prints available. Not used for training since 1978. Price £3,500 DM. Address: Wolfgang Stang, Auf der Kohlstatt 33, 8871 Rettenbach, West Germany. Tel. 08223 7423.

Slingsby Cadet - needs restoration. All parts available except for struts. Ailerons and tailplane already fabric covered. Can be inspected by appointment at Eric Rolfe's house, London Road, Moreton in the Marsh. Tel. 0608 50530.

Castel C.25S - side by side two-seater. Designed 1941. Built 1947. One of the two standard French training two-seaters of the period. More than 100 built at Air sur Adour between 1945 and 1948. Once flew French two-seater distance record of 370 kms. It can be inspected by appointment at Eric Rolfe's house - above address and telephone number. Offers to: Billie Caldwell, 14 The Towers, Grand Avenue, Worthing. Tel. 0903 40418. Ideal fun glider. Closed canopy and cantilever wings.

Grunau Baby on an open trailer, without C of A. Kept by Fred Butcher at Greycott Farm, which is close to Wroughton Private Airstrip. Price £500. Owner is B. Eyles. Tel. North Ferney (029 583) 313 Gloucester.

For the magnificent photographs on this double page we are very much indebted to our member and aeromodeller, Ian Tunstall.

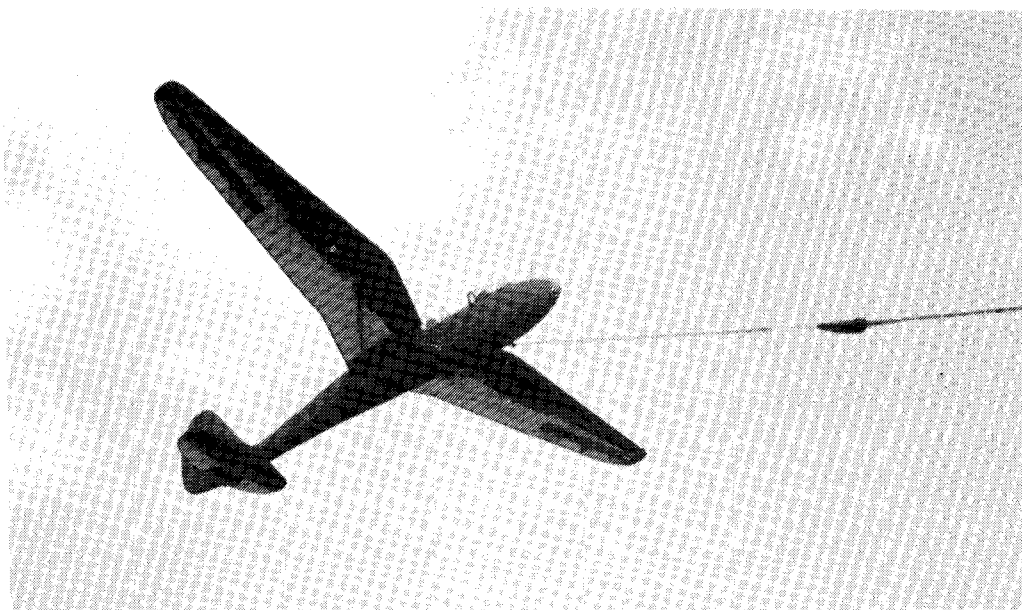

The sensation of our Bicester Rally, the recently restored Shenstone/Czerwinski Harbinger. If Fred Coleman, its builder, could see it now, he would be happy.

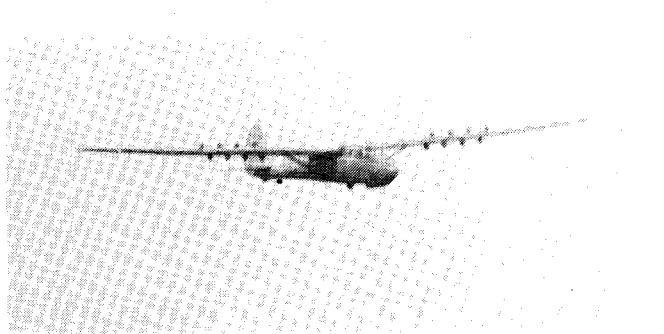

The Harbinger's air brakes defy the imagination.

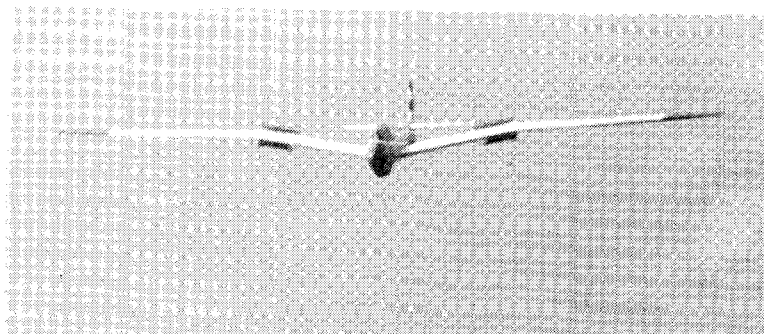

The Mg 19a revealing its air brakes.



Kevin Sedgman, Australian pioneer glider pilot, who has for many years been leading the Scouts' Gliding Club at Blanchtown, South Australia, and Sheila Tunstall, champion womens' golfer, in the Mg 19a.

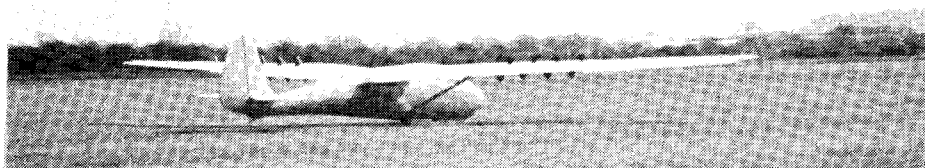

Harbinger landing.

All photographs were kindly made available by Ian Tunstall.



To honour our aeromodeller members, who have built some brilliantly fine models of our vintage gliders, Ian Tunstall launches his model Mg 19 at a recent contest on the Wiltshire Downs.

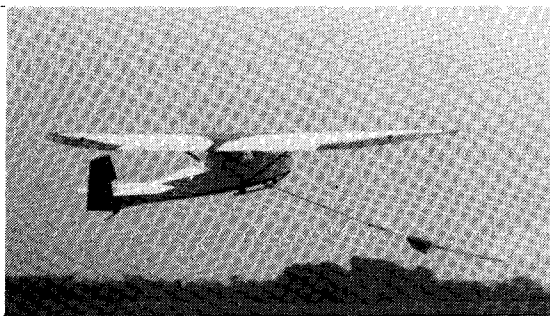

Harry Chapell's 1944 Flugzeugbau Petera Grunau Baby 2b lifts off at Bicester.

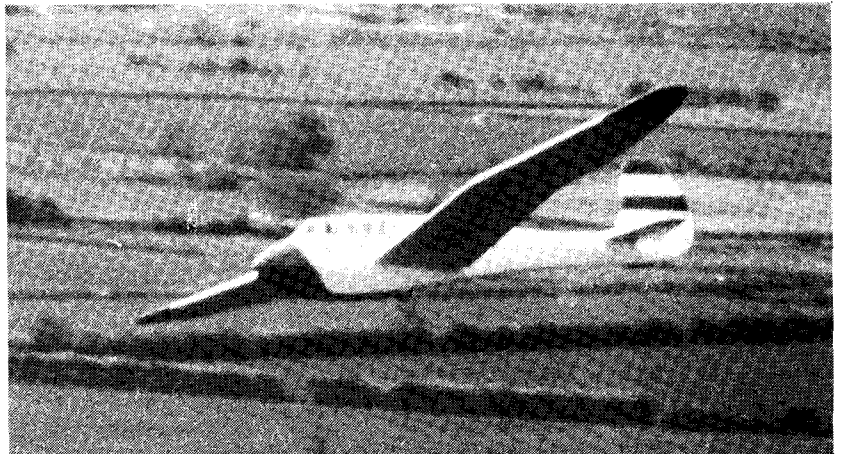

Not the full size Mg 19 indulging in some low hill soaring, but Ian Tunstall's model at the Wiltshire Downs Contest.

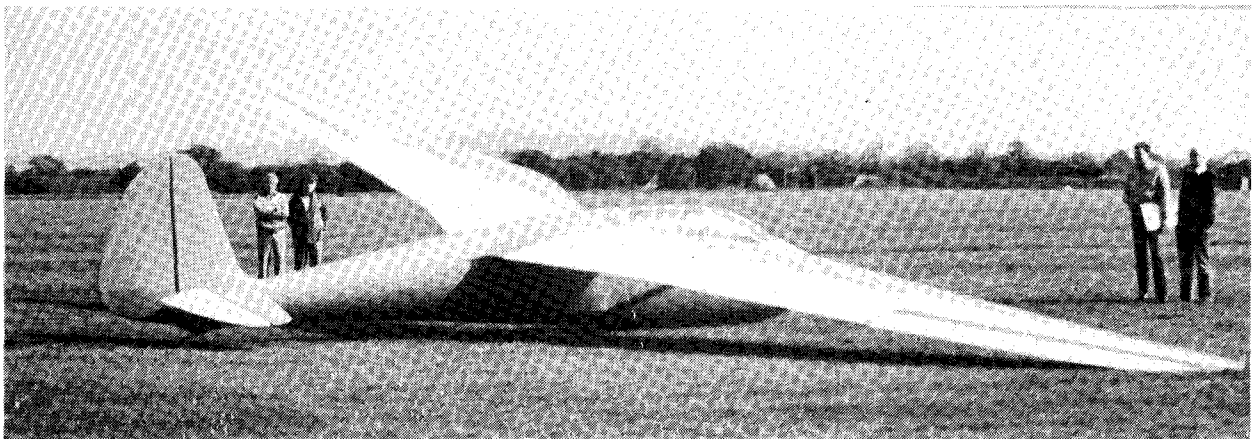

The Harbinger, in which are marching the ghosts of the vanished pre-war PWS sailplanes. Another is said to languish in store on an open trailer at the Ottawa Museum, Canada, and they do not even know what it is.

Two Video Cassettes of ancient gliding films - VHS or Betamax. Each runs for over an hour, with sound commentaries. The first is "Gliding Till Now" by Lawrence Wright 1960. Period from Leonardo de Vinci until Goodhart and Foster's win in 1956 of the World Two Seater Class. The second includes the Nyborg film "Plane Sailing 1936" and others. £35 each to cover huge financial outlay. C. Wills, "Wings", The Street, Ewelme, Oxon OX9 6HQ. Tel. 0491 39245.

Eon Olympia 2b - Crusaders' GC, Cyprus. Sqdn. Ldr. Mackay, RAF 33 Signals Unit, Ayios Nikolaos, B.F.P.O. 58, Cyprus. The aircraft is airworthy and very cheap. Perhaps it will be sold for £300. RAF could arrange its transport to Britain in a Hercules.

**W-W-1**



**Aero**  
THE JOURNAL OF  
THE EARLY AEROPLANE

Join collectors, restorers, replica builders, historians, and modellers all over the world in the only authoritative organization devoted to Those Magnificent Flying Machines.

Receive five issues a year of WW1 AERO featuring all types of aircraft 1900-1919, each issue containing histories, photographs, construction drawings, engines, performance data, models, and lore written by experts. Learn about projects all over the world. Discover the most complete source for information, parts, models. Published regularly since 1961.

SAMPLE ISSUE \$4.00

**WORLD WAR 1 *Aeroplanes*, INC.**  
15 Crescent Road, Poughkeepsie, NY 12601, USA

```

*****
*
*   SUPPORT YOUR CLUB   *
*
*   The V.G.C. Has for Sale   *
*
*   Tee-Shirts  Sweat-Shirts  Ties   *
*
*   Key Rings  Pens  Pencils   *
*
*   and much more, all with club emblem   *
*
*   For details and price list contact   *
*
*   P.F. Woodcock 61 Matlock Road   *
*   SHEFFIELD S6 3RQ (England)   *
*   Tel.(0742) 349875   *
*
*****

```

Published by:

C. Wills,  
"Wings",  
The Street,  
Ewelme,  
Oxon.

Tel. 0491 39245

R. Traves,  
"Rose View",  
Marden Road,  
Staplehurst,  
Kent.

Tel. 0580 891625

Secretary's Note

I must apologise for the extreme lateness of these accounts. However, the problems have been solved now and we expect to publish the accounts for 1983 and 1984 in the next VGC News.

VINTAGE GLIDER CLUB

INCOME AND EXPENDITURE ACCOUNT

FOR THE NINETEEN MONTHS ENDED

31st DECEMBER 1982

	<u>£</u>	<u>£</u>
<u>INCOME</u>		
SALES		761.46
SUBSCRIPTIONS AND DONATIONS		2,210.61
OVERSEAS POSTAGE		367.14
TECHNICAL ARTICLES		71.20
MISCELLANEOUS INCOME		11.50
DUNSTABLE RALLEY SURPLUS		56.00
BANK DEPOSIT INTEREST		<u>505.61</u>
		3,983.52
<u>EXPENDITURE</u>		
STOCKS AT COST	600.68	
PURCHASES FOR RESALE	1,088.94	
POSTAGE	455.91	
NEWSLETTER	1,419.54	
STATIONERY	173.96	
RALLIES	198.98	
ANNUAL DINNER	301.79	
MEMBERS EXPENSES	317.40	
AUDITORS REMUNERATION	65.00	
BAD DEBT	3.22	
DEPRECIATION	<u>10.00</u>	
<u>Less:</u>	4,635.42	
STOCKS AT COST	<u>793.33</u>	<u>3,842.09</u>
<u>SURPLUS FOR THE PERIOD</u>		<u>£ 141.43</u>

NOTES TO THE ACCOUNTS

1. STOCK HAS BEEN VALUED AT COST TO THE CLUB.

VINTAGE GLIDER CLUB

BALANCE SHEET - 31st DECEMBER 1982

	<u>£</u>	<u>£</u>
<u>FIXED ASSETS</u>		
EQUIPMENT, LESS DEPRECIATION		41.00
<u>NET CURRENT ASSETS</u>		
STOCKS AT COST	793.33	
CASH IN HAND	1.85	
CASH AT BANK	<u>2,583.38</u>	
	<u>3,378.56</u>	
 <u>Deduct:</u>		
<u>NET CURRENT LIABILITIES</u>		
8th INTERNATIONAL	73.00	
SECRETARIES EXPENSES	67.40	
AUDITORS REMUNERATION	<u>40.00</u>	
	<u>180.40</u>	
<u>NET CURRENT ASSETS/(LIABILITIES)</u>		<u>3,198.16</u>
		<u>£3,239.16</u>
 <u>REPRESENTED BY:</u>		
INCOME AND EXPENDITURE ACCOUNT BROUGHT FORWARD		409.12
<u>Add:</u>		
SURPLUS, 8th INTERNATIONAL		514.11
NO.1 FUND		1,408.07
NO.2 FUND		254.93
NO.3 FUND		11.50
SURPLUS FOR THE PERIOD 1/6/81 TO 31/12/82		<u>141.43</u>
		2,739.16
INTERNATIONAL RESERVE		<u>500.00</u>
		<u>£3,239.16</u>

I HAVE EXAMINED THE ABOVE BALANCE SHEET DATED THE 31st DECEMBER 1982 WHICH IS IN ACCORDANCE WITH THE CLUB'S BOOKS OF ACCOUNT AND THE INFORMATION AND EXPLANATIONS GIVEN TO ME.

*M.E. Wakerly*

M.E. WAKERLY

INCORPORATED ADMINISTRATIVE  
ACCOUNTANT