

CORROSIVE RESISTANT TRULOK PRELUDE 24 TLX

24mm Exposed Suspension System

Key Attributes

- Corrosion resistance 700 hours salt spray test on grids according to EN ISO 9227 standards
- **Peakform** patented universal main runner profile
- The **Peakform** bulb design increases strength and stability for improved performance
- **Superlock** main runner clip engineered for a strong, secure connection and fast accurate alignment confirmed with an audible click
- Easy to cut due to the **Peakform** bulb
- Rotary stitched for additional torsional strength and extra stability during installation
- Main Runner slotted at 100mm centres for increased flexibility
- Prelude TLX cross tee with staked on hook clip end detail and butt cut end
- **TLX** clip is a unique composite construction that provides superior corrosion protection
- Easy to remove and relocate
- Armstrong Global White
- Full range of corrosive resistant suspension accessories

Peakform Main Runner 24 Corrosive Resistant with Superlock clip

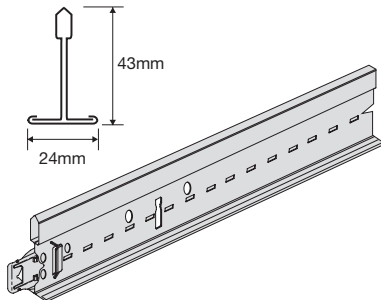

Item Nr.	Dimensions		Content /Carton		Weight/Carton kg	Cartons/Pallet
	length (mm)	height (mm)	pcs	lm		
BP 284042	3600	43	20	72.00	21.00	30

BP 284042	50	100	33 x 100	100	50
------------------	----	-----	----------	-----	----

Prelude 24 Corrosive Resistant TLX Peakform Cross Tees (Hook system, butt cut)

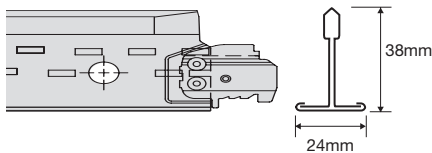

Item Nr.	Dimensions		Content /Carton		Weight/Carton kg	Cartons/Pallet
	length (mm)	height (mm)	pcs	lm		
BP 143032	1200	38	60	72.00	18.20	72
BP 142032	600	38	60	36.00	9.08	144

BP 143032	1200	300	300	300	300
------------------	------	-----	-----	-----	-----

All measurements are in millimetres.

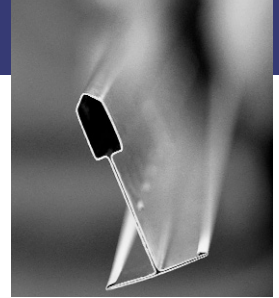

Perimeter

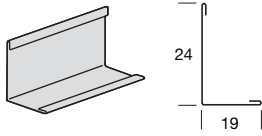

Item Nr.	Description	Dimensions		Content /Carton		Weight/Carton kg
		length (mm)	height (mm)	pcs	lm	
BPT 1924 LB	Corrosive resistant perimeter angle	3050	0.45	36	109.80	27.60

Accessories

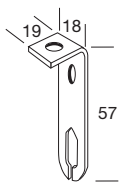

BPA WDNCR 20 H Bent tee bar hanger for threaded rod

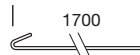

BPA CR827 G 1700mm hanger with hook

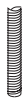

BPA CR1829 G Threaded rod dia. 6mm

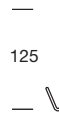

BPA CR11 G Small hook



BPA CR1827 G Nut for threaded rod

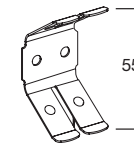

BPA CR12 G Butterfly

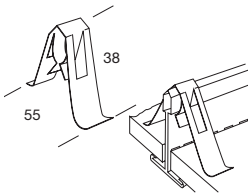

BPA CR7890 G Universal retaining clip

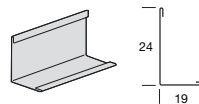

BPT 1924 LB Corrosive resistant suspension angle

Physical Data

- **Material**
Double-web pre-painted steel
- **Surface Finish**
Baked polyester paint
- **Product Family**
Exposed tee system
- **Main Runner/Cross Tee Interface**
TLX clip hook system
- **End Detail**
Main Runner : bulb-to-bulb connection, staked-on **Superlock** clip, single stitching
TLX cross tee : staked-on TLX clip, double stitching

Load Capacity

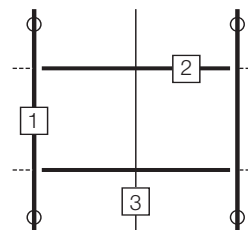

Maximum load = 10.5kg/m²
Suspension points at 1200mm centres, deflection L/500 (4mm max.) according to EN13964 standard

- 1 **BP284042**
- 2 **BP143032**
- 3 **BP142032**

All measurements are in millimetres.

United Kingdom
Republic of Ireland
Armstrong World Industries Ltd.
Building Products Division
Armstrong House
38 Market Square
Uxbridge UB8 1NG

0800 371849 (UK) **1800 409002 (ROI)** **FREEPHONE**
Fax: +44 (0) 1895 274287
www.armstrong-ceilings.co.uk
www.armstrong-ceilings.ie
sales-support@armstrong.com
Other markets: www.armstrong-europe.com

