

LCP-PD9-FTS-UK

LUTRON CONTROL PANEL - 9 RAIL
FEED THROUGH SIDE - UK SPEC

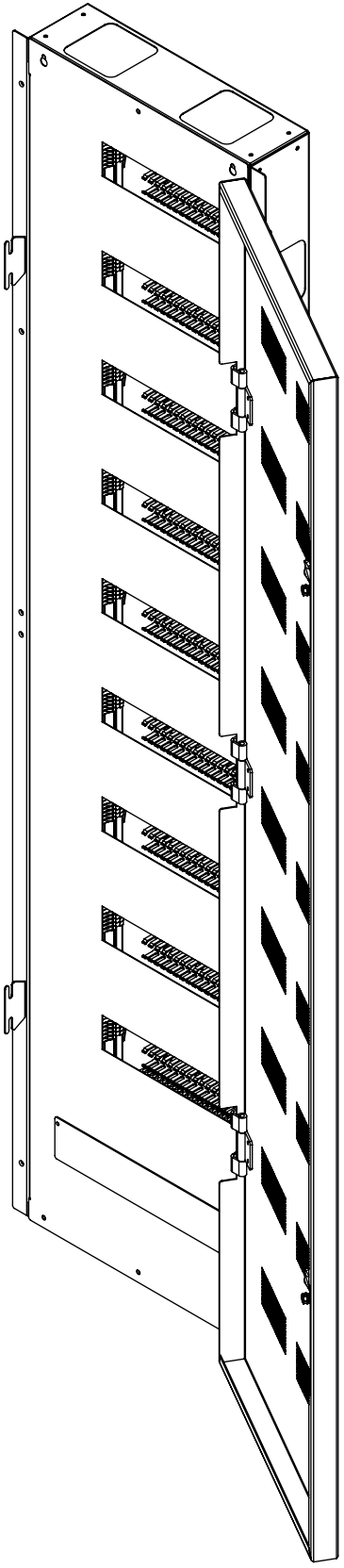

future automation



LCP-PD9-FTS-UK

LUTRON CONTROL PANEL - 9 RAIL FEED THROUGH SIDE - UK SPEC



future automation

SPECIFICATION	MEASUREMENTS
Product Dimensions	1623mm (63.9") x 401mm (15.8") x 138.5mm (5.5")
Number of DIN Rails	9
Finish (Custom Available)	Lid - Black Textured Paint, Box - Zintec Coated Steel
Depth From Wall	141.5mm (5.6")
Wall Mount Type	6.5mm (0.26") Keyhole Slots
Shipping Dimensions	1740mm (68.5") x 550mm (21.7") x 240 (9.5")
Shipping Weight	27.0Kg (60lbs)

LCP-PD9-FTS-UK



future automation

LUTRON CONTROL PANEL - 9 RAIL FEED THROUGH SIDE - UK SPEC

ENCLOSURE DIMENSIONS

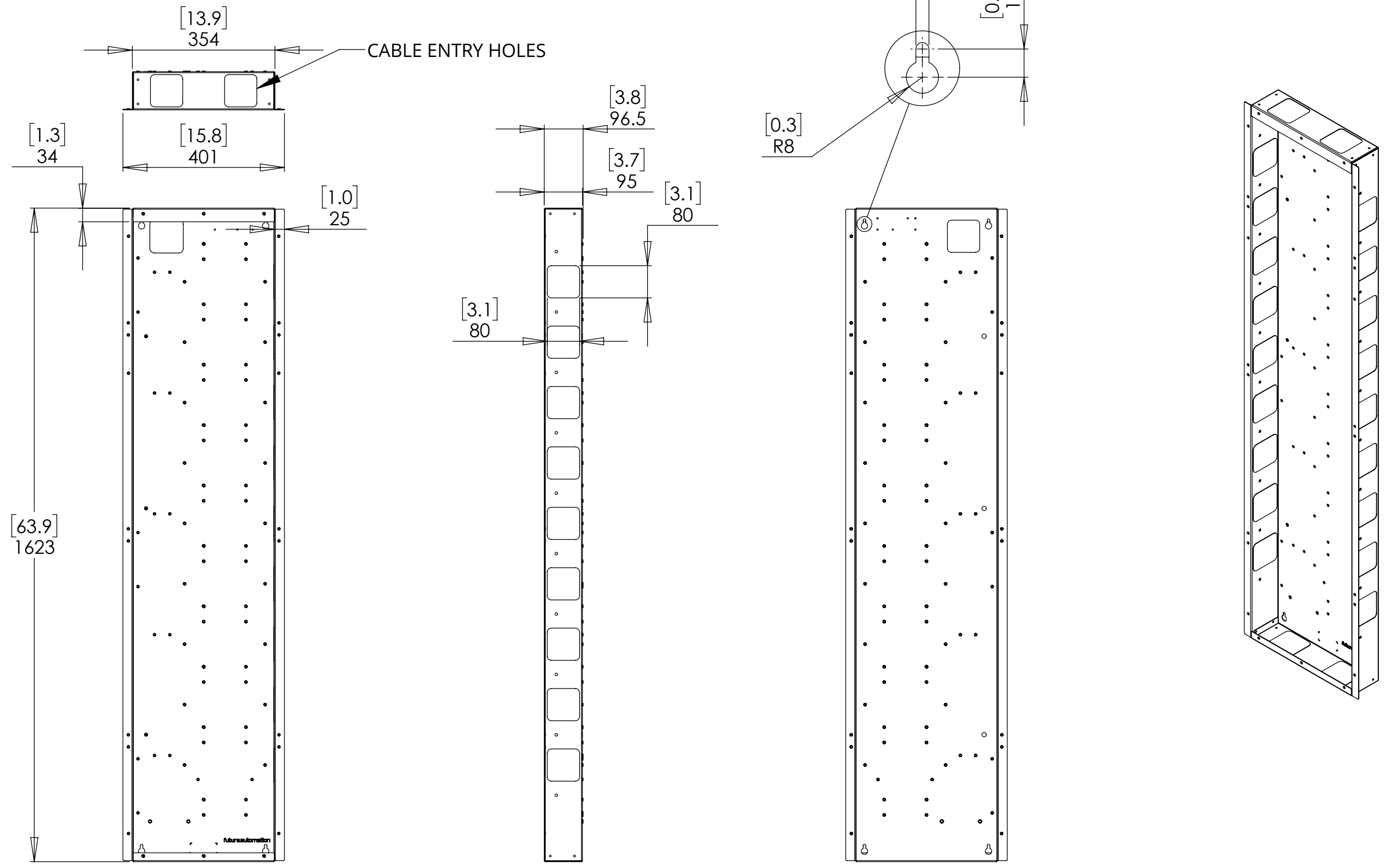

LCP-PD9-FTS-UK

LUTRON CONTROL PANEL - 9 RAIL FEED THROUGH SIDE - UK SPEC

OVERALL DIMENSIONS

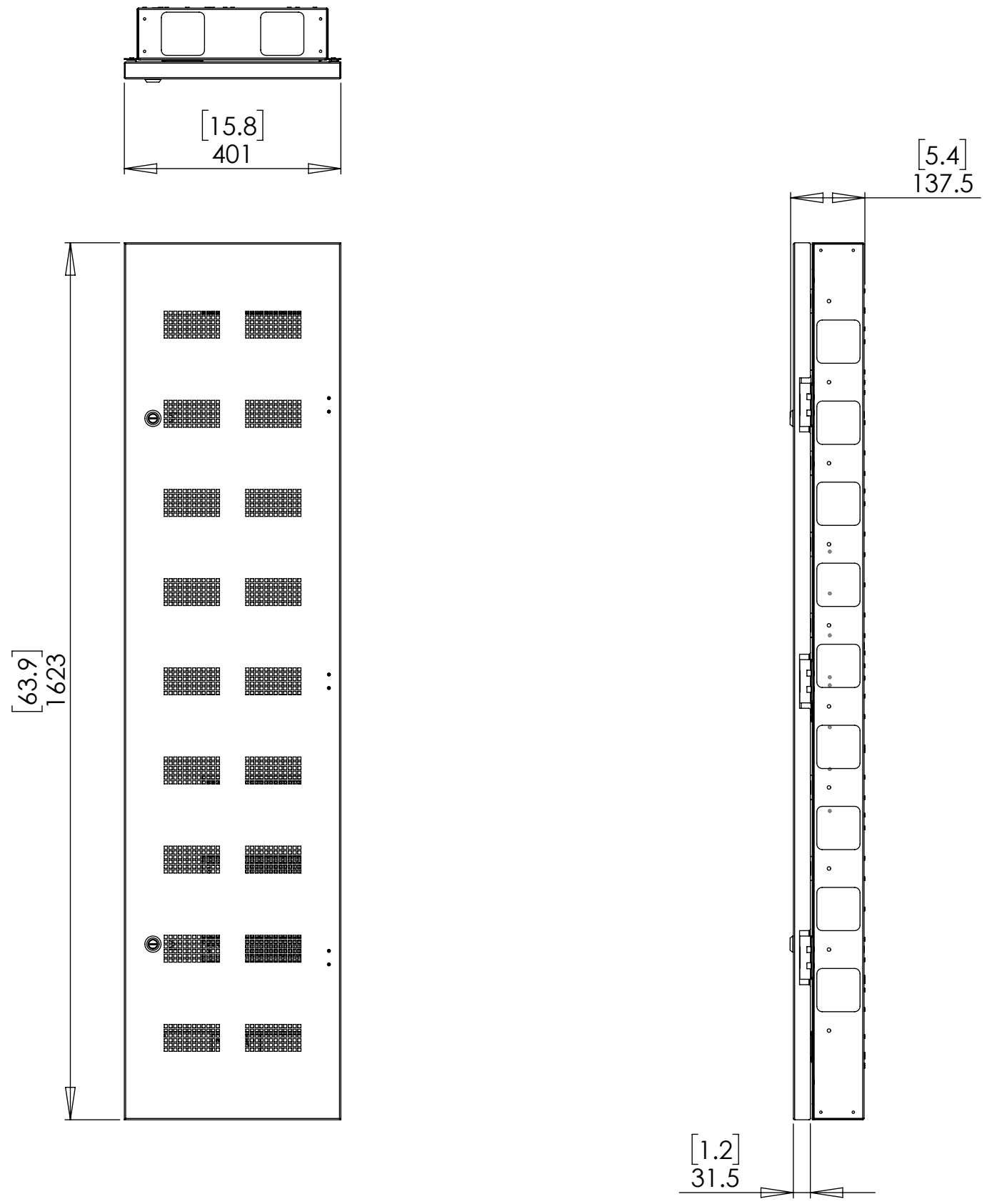

LCP-PD9-FTS-UK

LUTRON CONTROL PANEL - 9 RAIL FEED THROUGH SIDE - UK SPEC

PANEL BOX LAYOUT

Exploded View

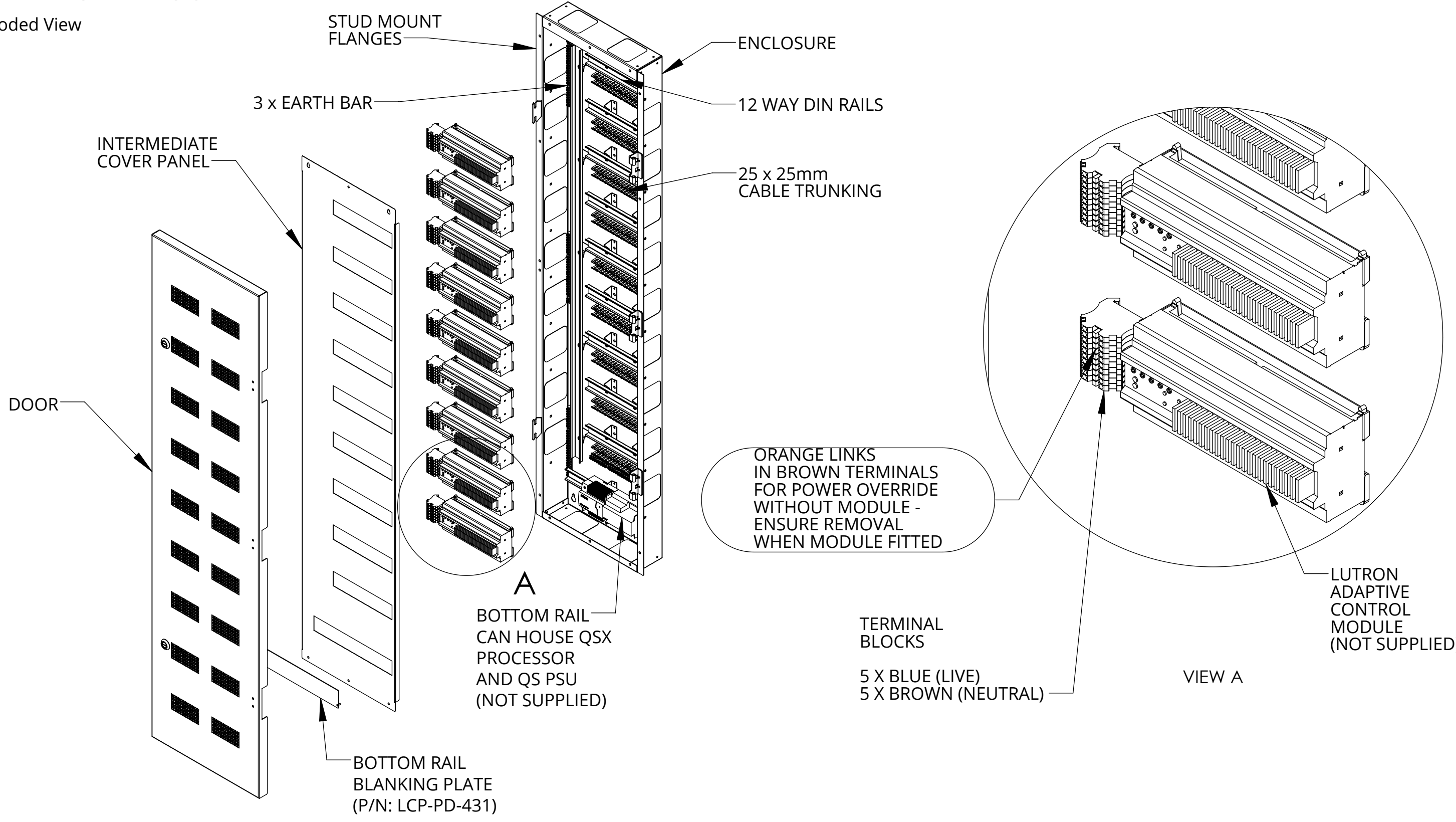



LCP-PD9-FTS-UK

LUTRON CONTROL PANEL - 9 RAIL FEED THROUGH SIDE - UK SPEC

PANEL BOX LAYOUT

Front cover removed
and example PS (Power Supply)
add on unit shown

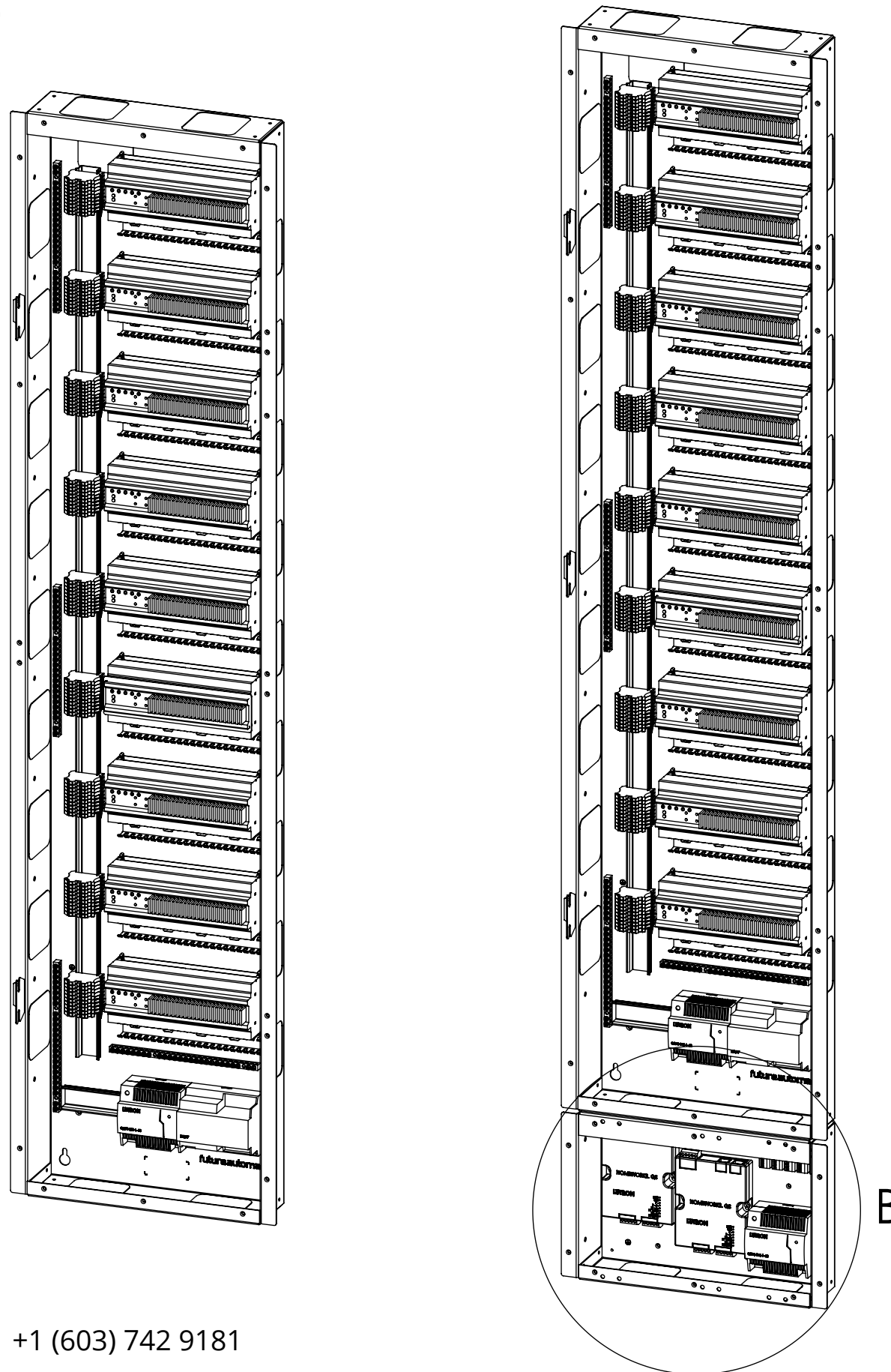

LCP PDPS - POWER SUPPLY ADD ON UNIT (NOT SUPPLIED)

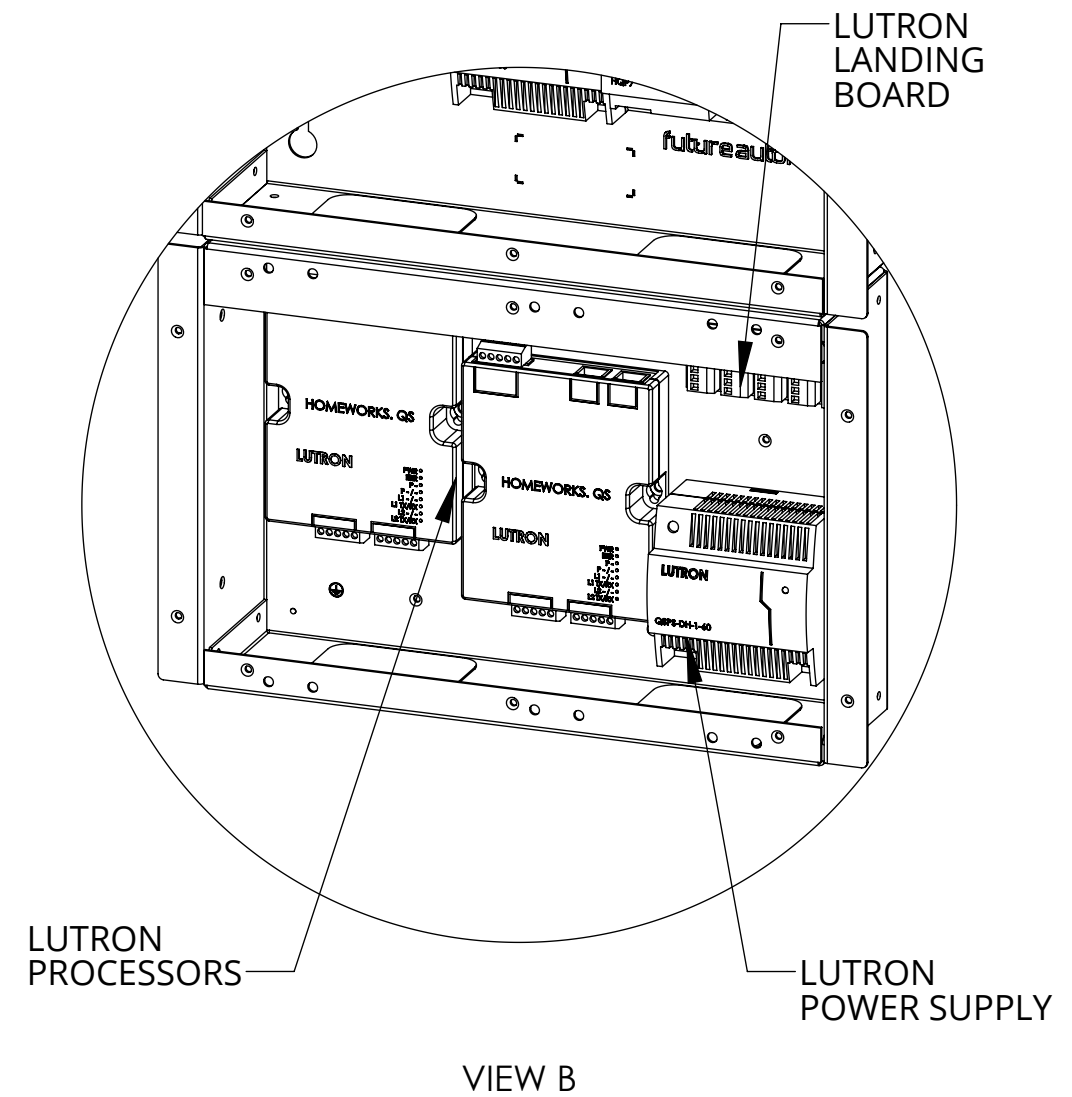



LCP-PD9-FTS-UK

LUTRON CONTROL PANEL - 9 RAIL FEED THROUGH SIDE - UK SPEC

REVERSIBLE DOOR OVERVIEW

Door shown opening towards the right hand side

In order to switch to left hand side opening, simply remove front cover panel and swap latch brackets and hinge outers over

