



## DESIGN HIGHLIGHTS

- Quiet smooth action at approximately 40mm [1.6] per second
- Full cable management
- Wide range of mounting options
- 24V DC motor. Suitable for direct DC supply
- Robust lifting beam

## OPTIONS

- Heavy duty option

## NON-TELESCOPIC OPTIONS

- Box Enclosure with Swivel
- Box Enclosure
- Advance & Rotate
- Custom screen back cover

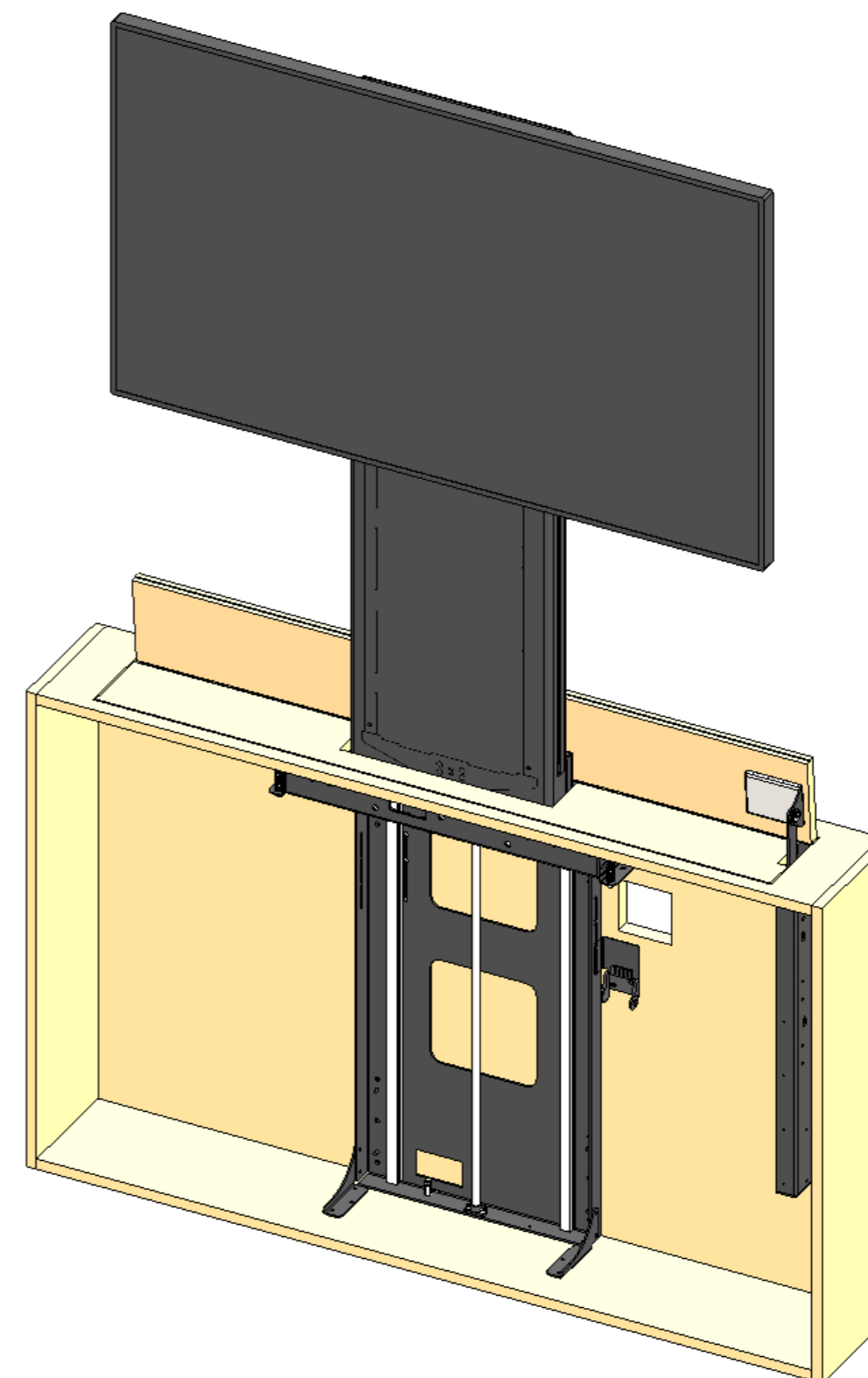
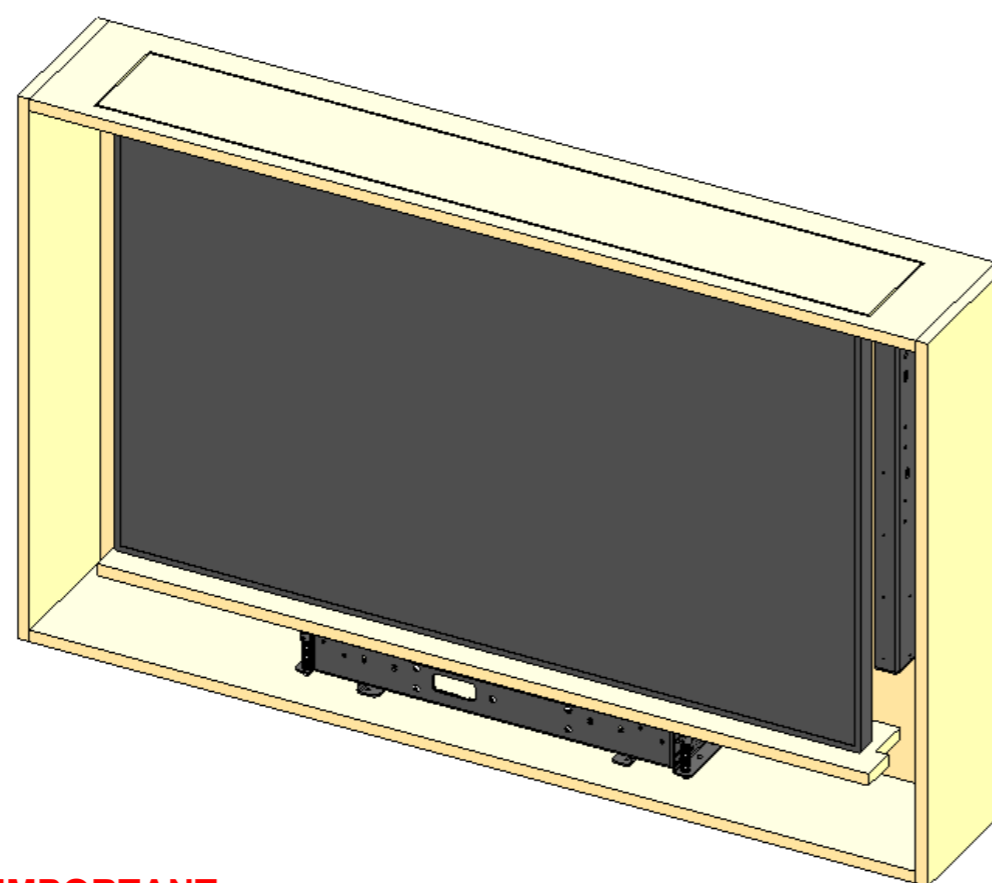

## FUNCTION

An electric mechanism to lift a flat screen television. Shown for use with a Telescopic Unit and Heavy Duty Electric Flap Unit.

## SUITABILITY

Suitable for a total lifting weight of 30Kg [66lbs]

Maximum Screen Height  
920mm [36.2]

Maximum Screen Depth  
60mm [2.4]

Maximum Lift Distance  
1495mm [58.9] (Top edge of screen to cabinet top)

Lift systems to suit different screen heights are available.

## SPECIFYING

Check screen mounting details and request a suitable mount plate

## CONTROL

Supplied with basic infrared remote. Can be learnt by many learning remotes.

Also has switch control and RS232 so can be operated by relays, switches, Crestron / AMX or Lutron systems.

## WARNING

It is the responsibility of the installer to warn all potential end users of the dangers of interfering with mechanisms during operation

## IMPORTANT

Mechanisms which lift or move weights need to be checked on a yearly basis for any damage which may result in an accident

## Design Highlights

A space efficient and robust lifting mechanism.

A robust 24V DC motor with a purpose made lead screw enables a quiet and smooth lifting action at approximately 40mm [1.6] per second.

High precision linear guideways ensure stability and durability of the beam to prevent any unwanted movement of the screen.

Adjustable UP and DOWN positions allow for a precise final setup within the cabinet.

The safety switched base reduces the risk of damage to the mechanism or injury to the user by cutting power to the motor when there is an obstruction between the cabinet and base panel.

Full cable management protects all screen and power cables from damage and is easily accessible for future changes to the AV setup.

A wide range of mounting options are available to suit different screens and speaker arrangements.

The Heavy Duty Flap Actuator mechanism eliminates the need for a lid or box to be mounted around the screen.

The Telescopic Unit allows the screen to be lifted a further 575mm [22.6], producing a Maximum Lift Distance of 1495mm [58.9].

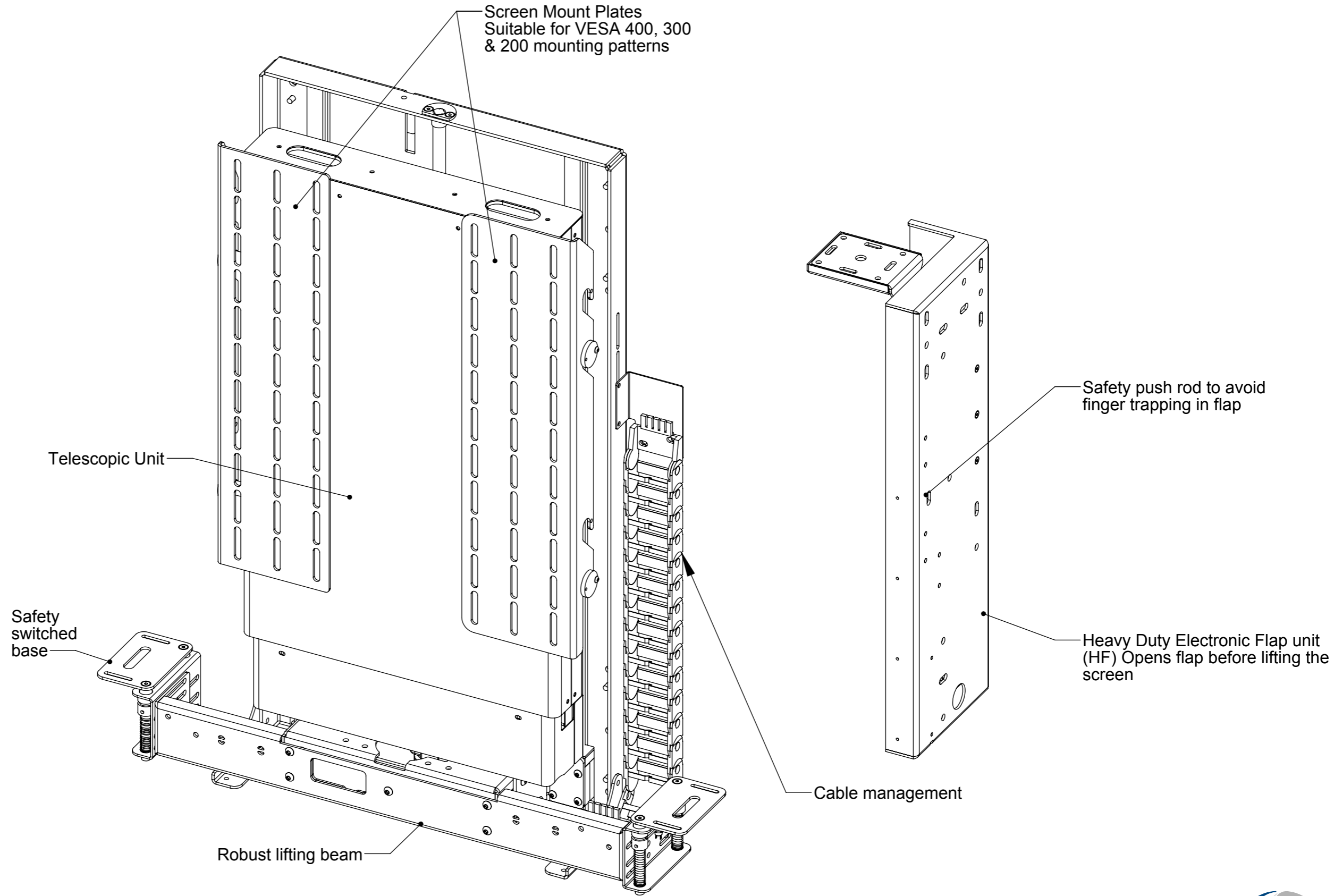

## Cable Routing

Screen Cables enter the top of the Telescopic Unit and are fed down through the Cable Track within. This can be accessed by removing the two front covers of the Telescopic Unit. The cables then pass through the LSM Beam and into the LSM Cable Track. Cables must be routed carefully to prevent any interference with the LSM beam as it operates.

Screen and Mechanism cables should be routed to a control box outside of the cabinet via an opening in the back of the cabinet or a conduit leading to the bottom.

- - - SCREEN CABLE
- - - MECHANISM CABLE
- - - POWER CABLE

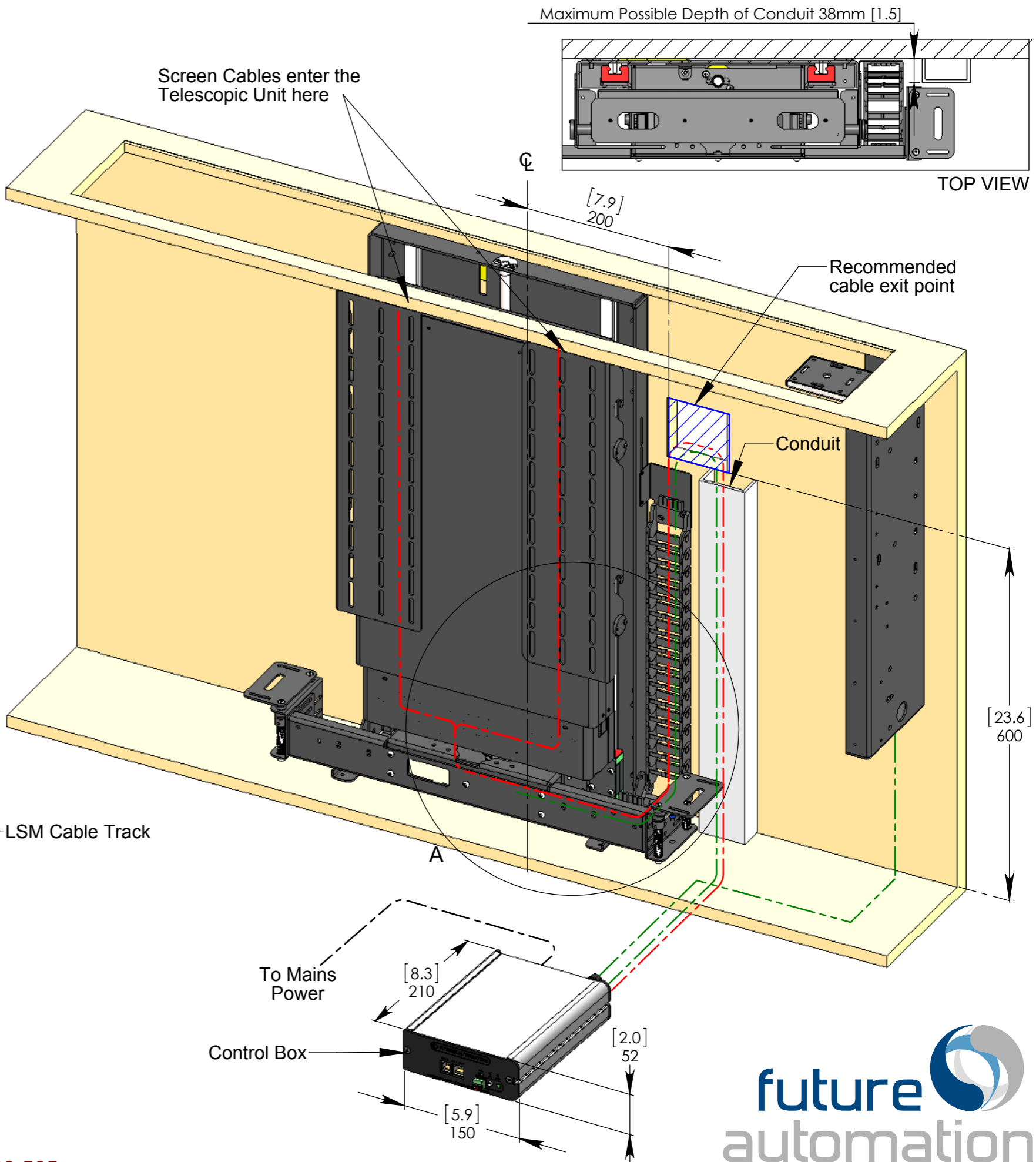
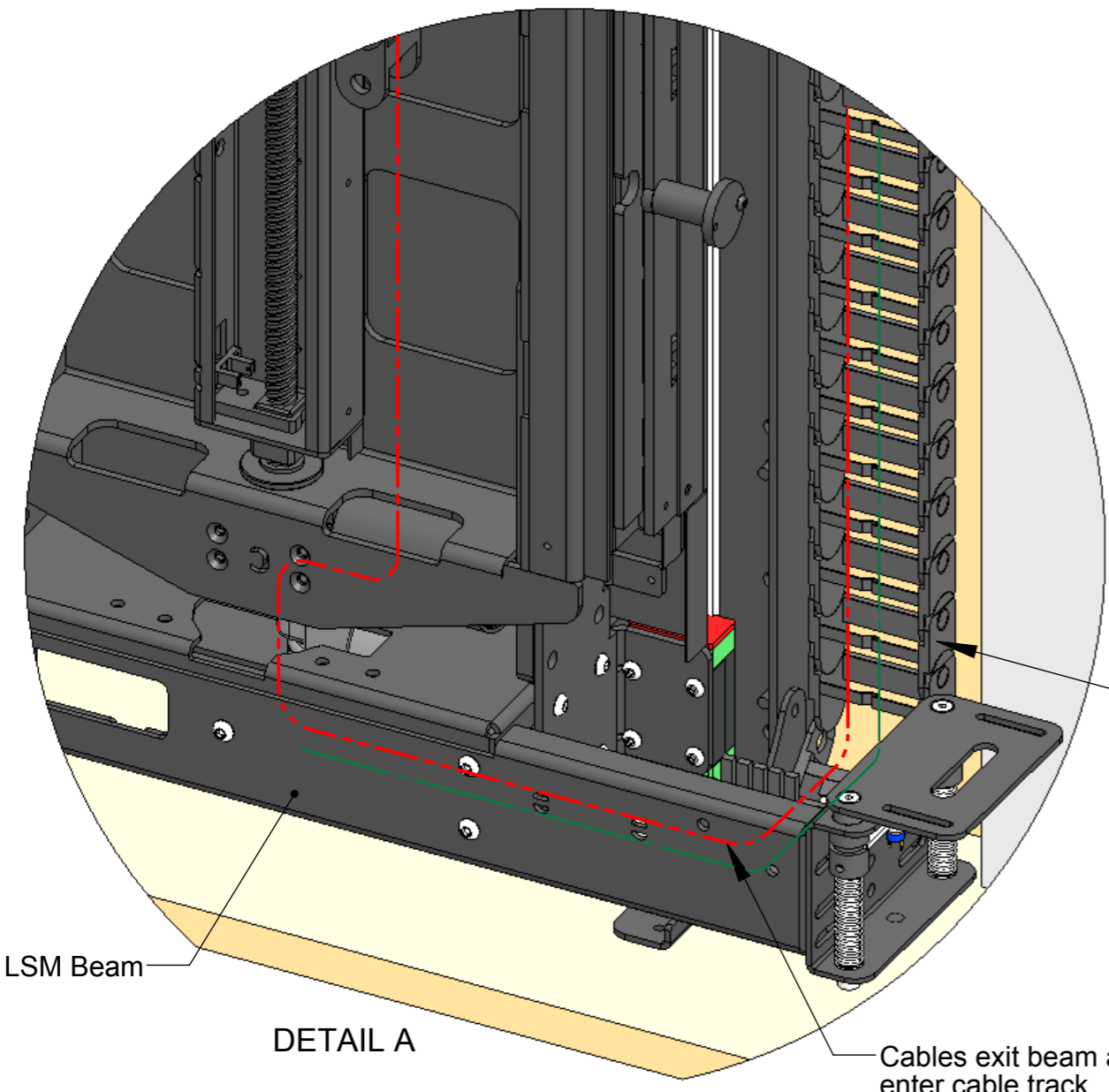

## Mechanism Up - In Cabinet

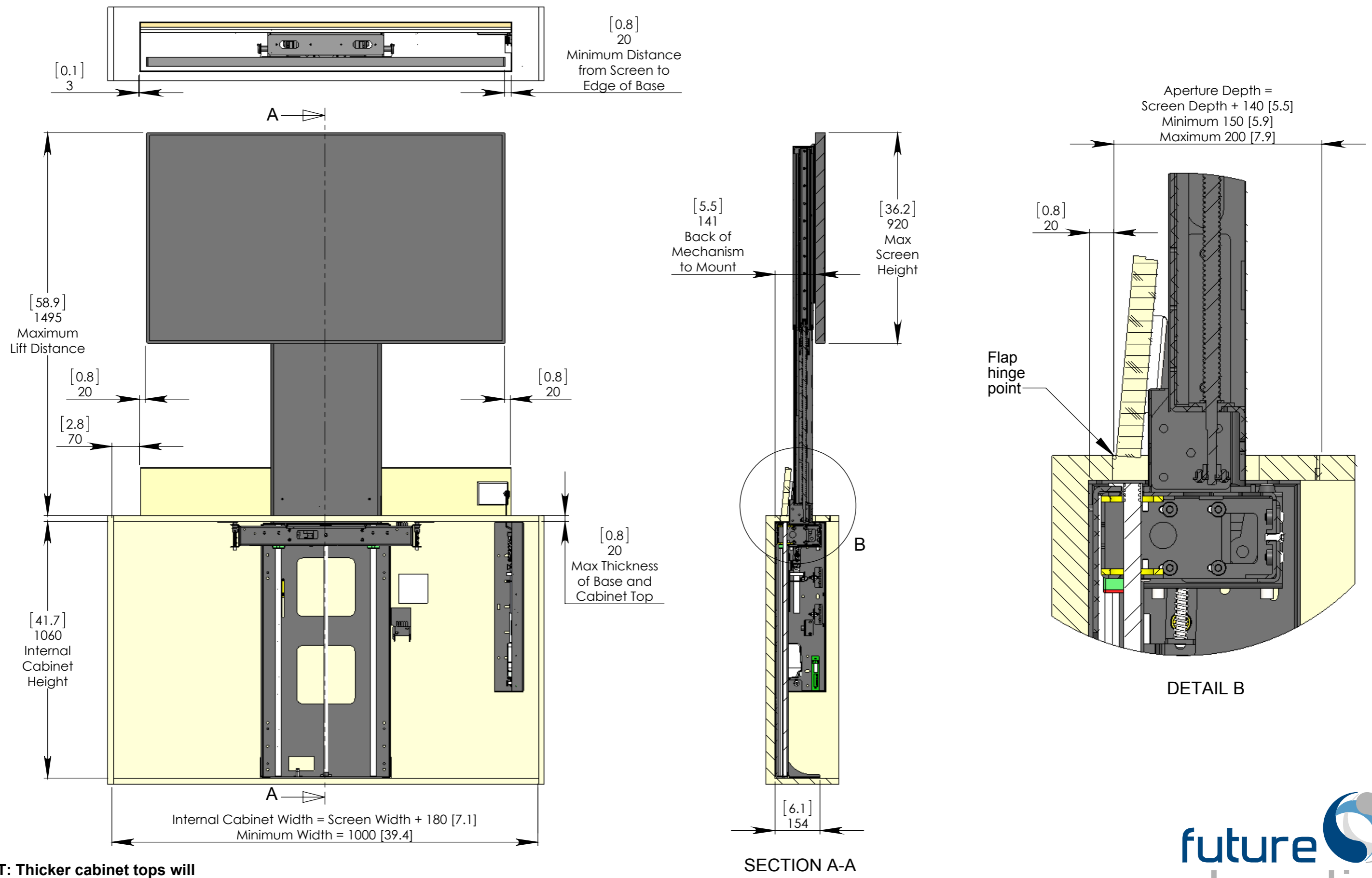

**IMPORTANT: Thicker cabinet tops will require a reduced maximum screen height**

## Mechanism Down - In Cabinet

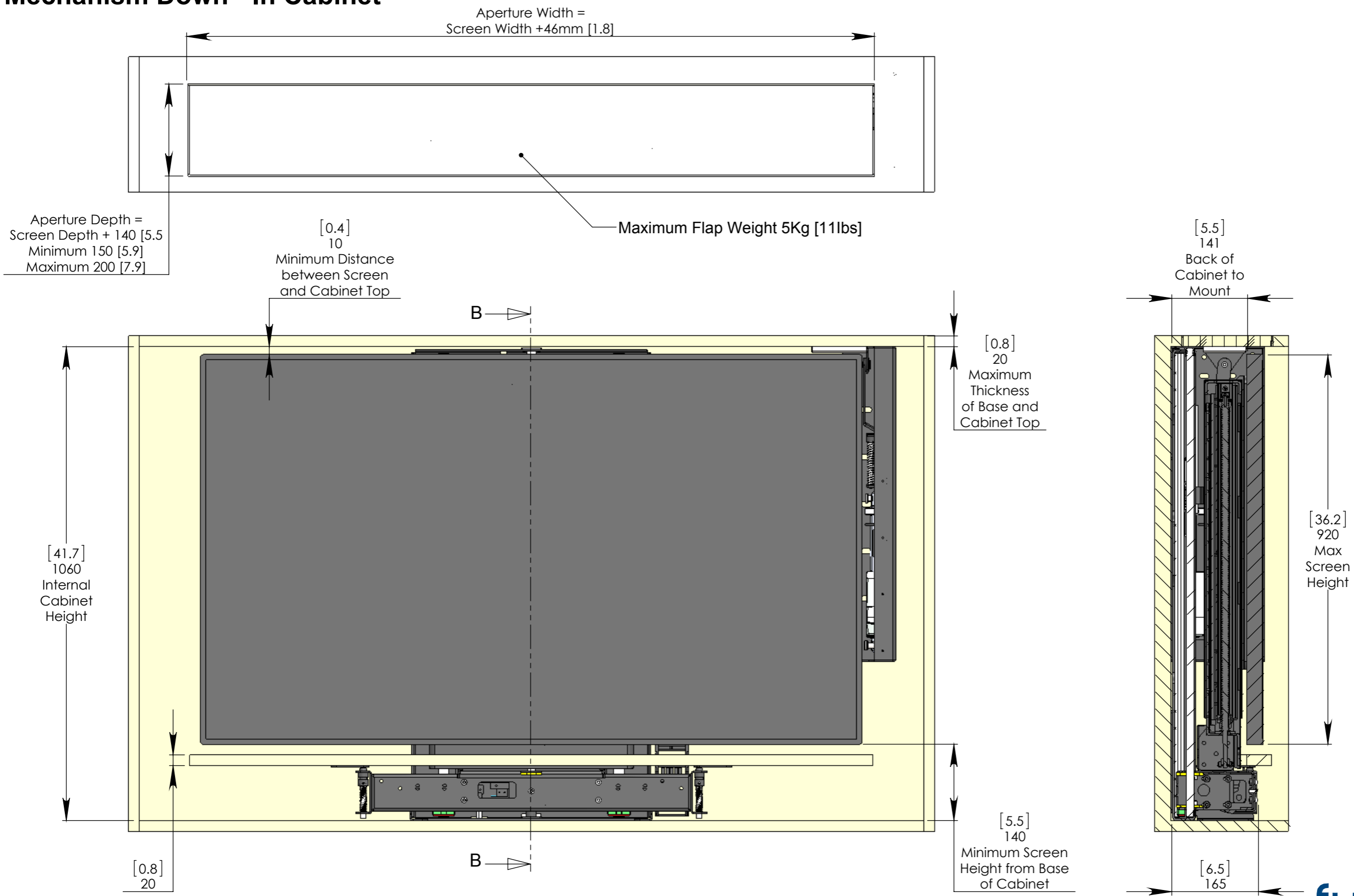

**IMPORTANT: Thicker cabinet tops will require a reduced maximum screen height**

## Base Panel and Flap Panel Details

Flap depth dimensions are based on a 3mm thick piano hinge

Required flap dimensions may vary dependant on the hinge used

**IMPORTANT: Flap Panel weight must not exceed 5Kg [11lbs]**

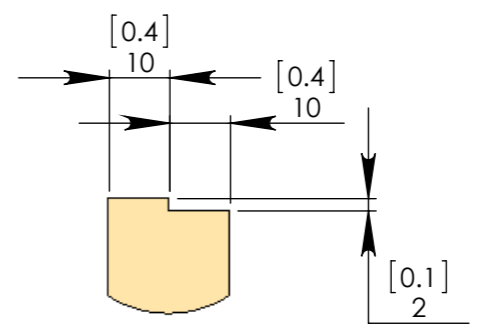

**FLAP PANEL - BOTTOM VIEW**

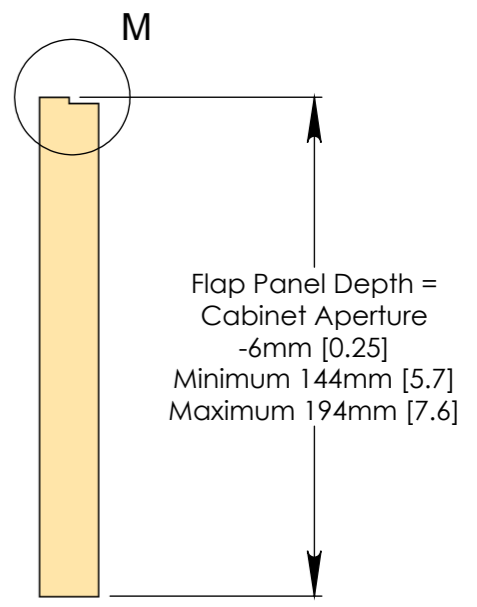
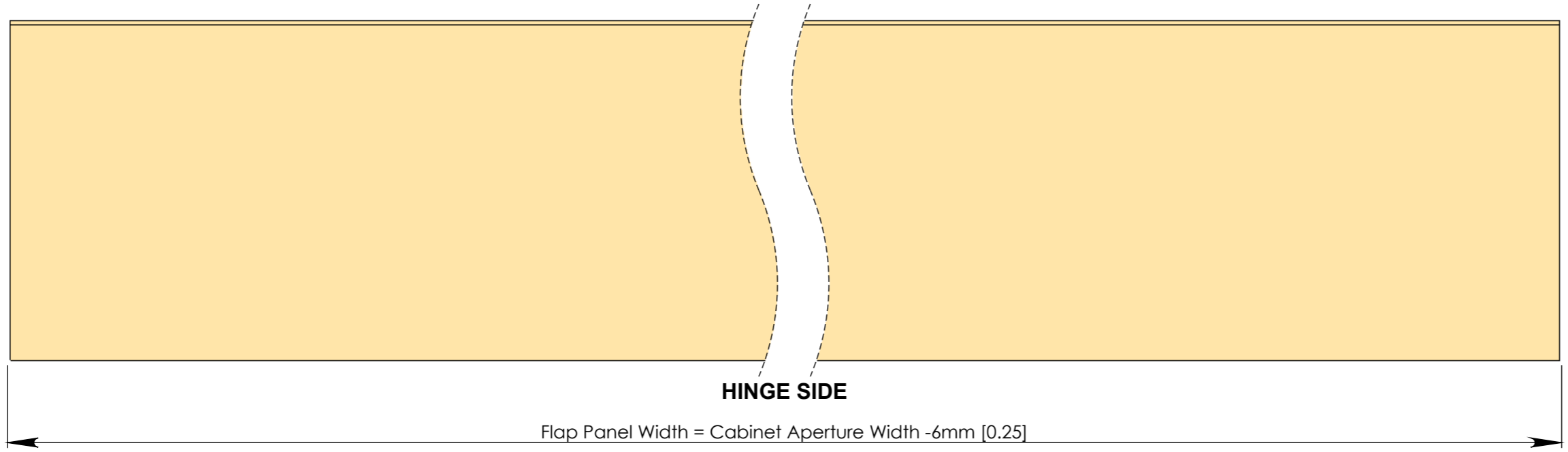

**BASE PANEL - TOP VIEW**

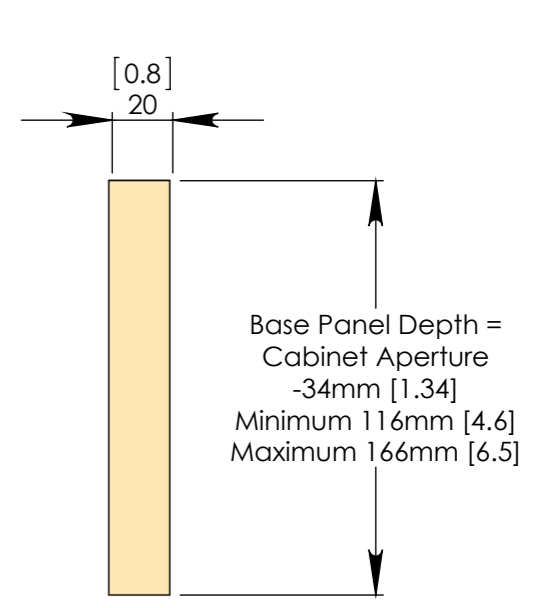
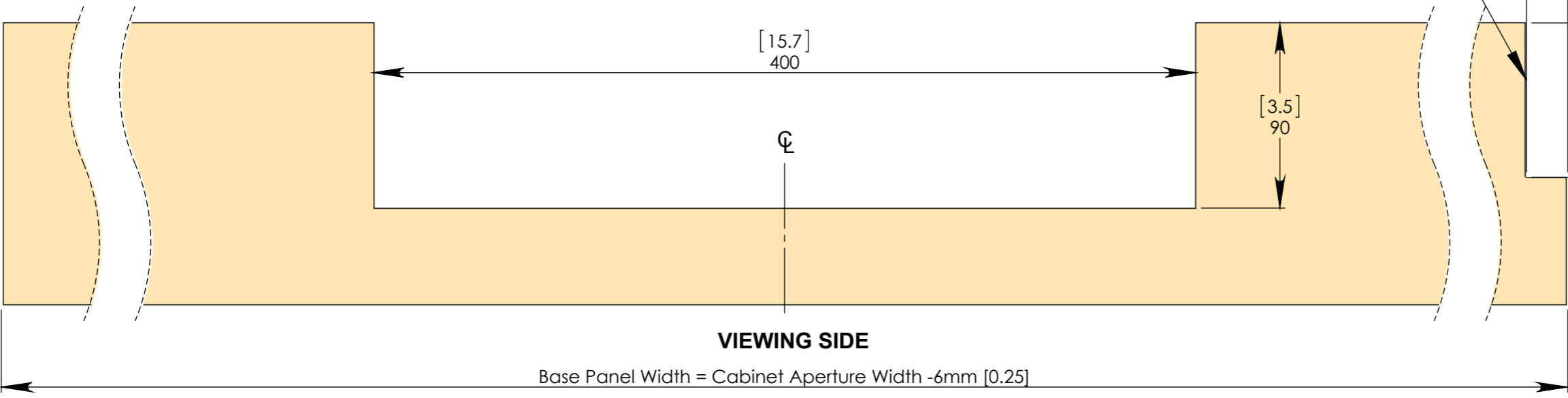

## Screen Mount Adjustability

A standard adjustable height VESA 400 mount is included. This is also compatible with VESA 300 and 200 mounting patterns

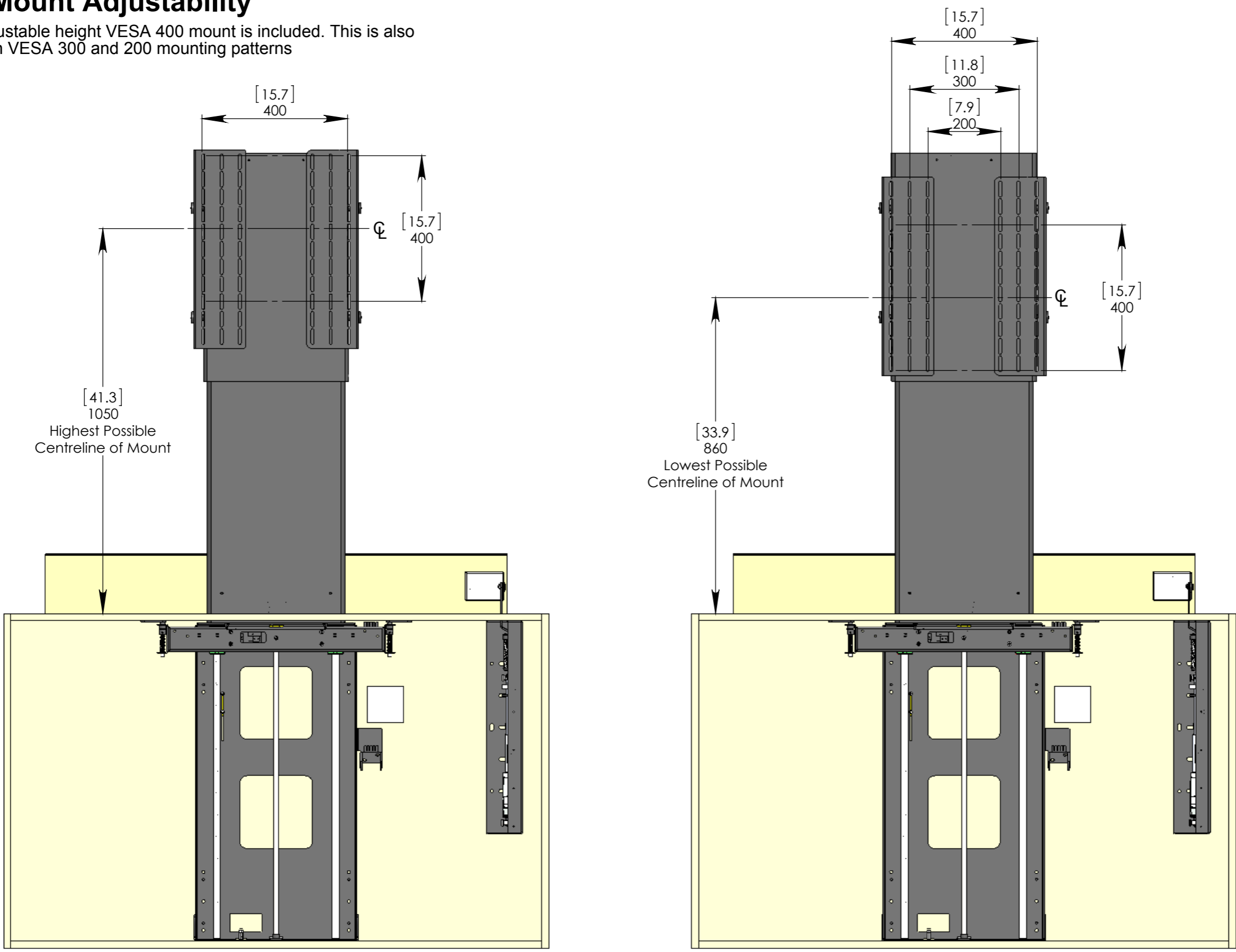

## Mechanism Installation Overview

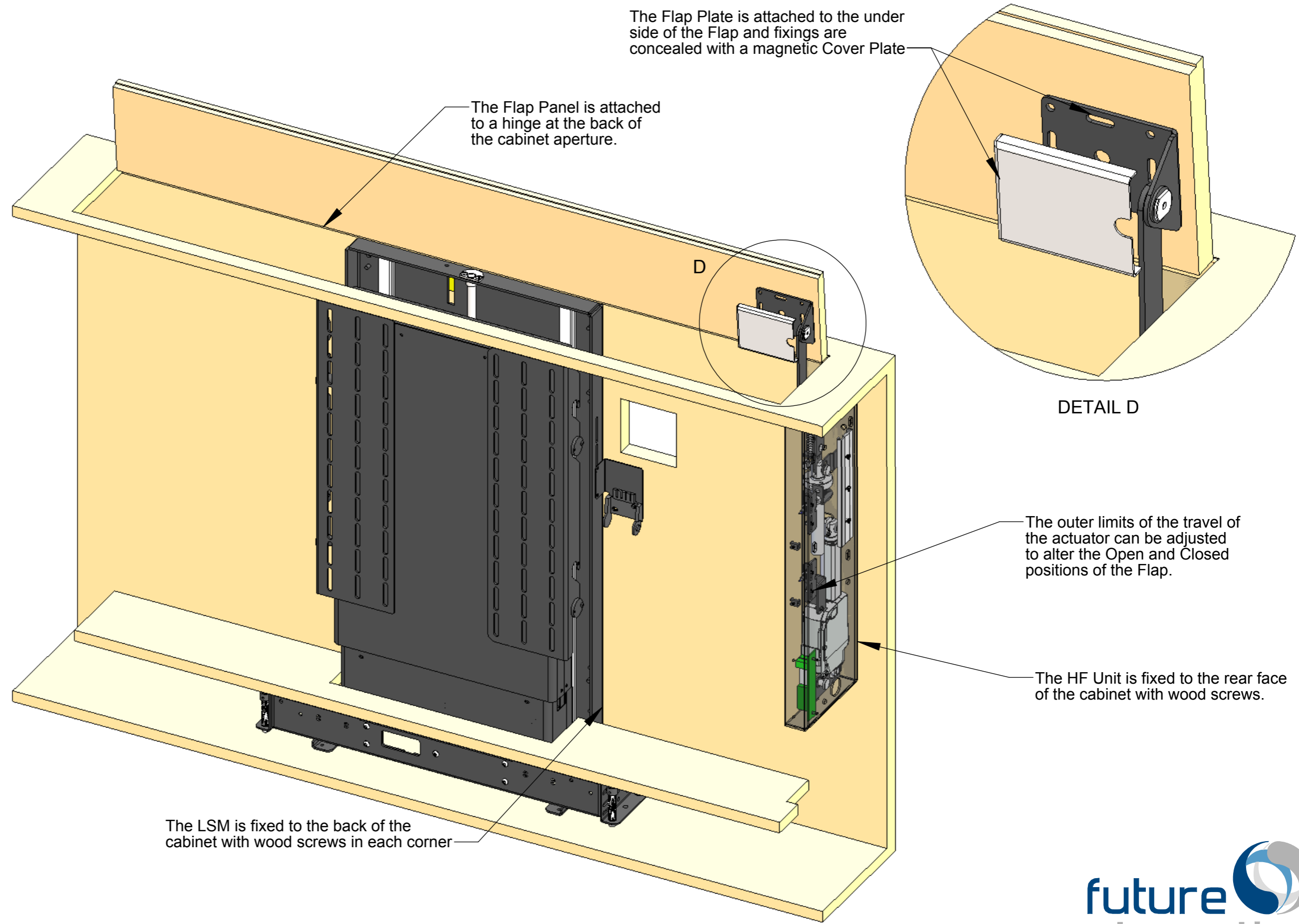



## Overall Mechanism Dimensions

MECHANISM - UP POSITION

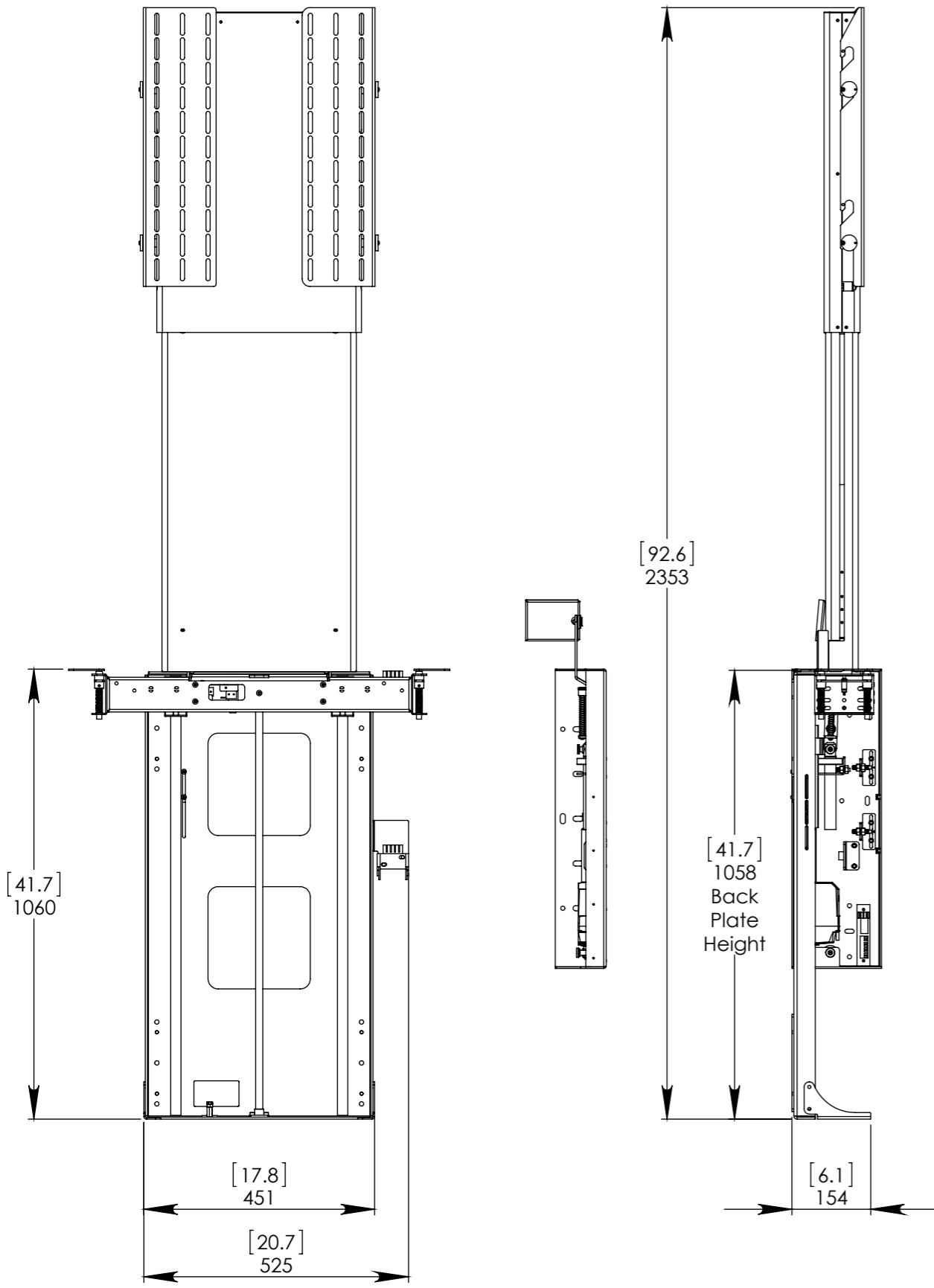

MECHANISM - DOWN POSITION

