

UNOCODE 399 EVO



PER:
FOR:

ABLOY (S)

OPTIONAL

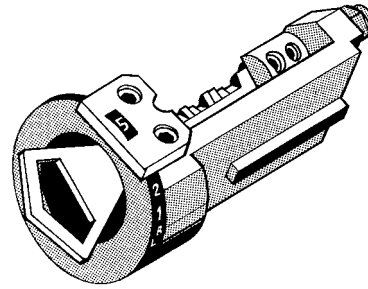
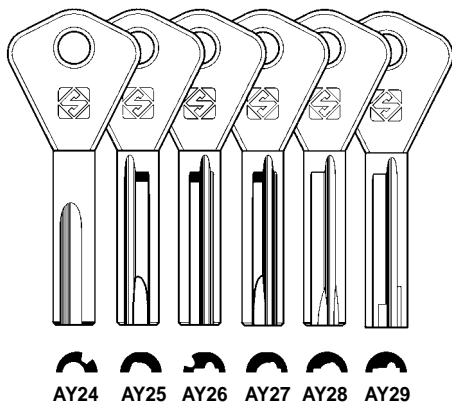
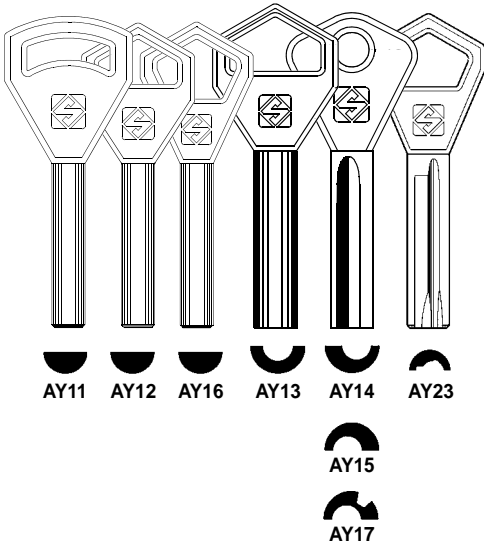
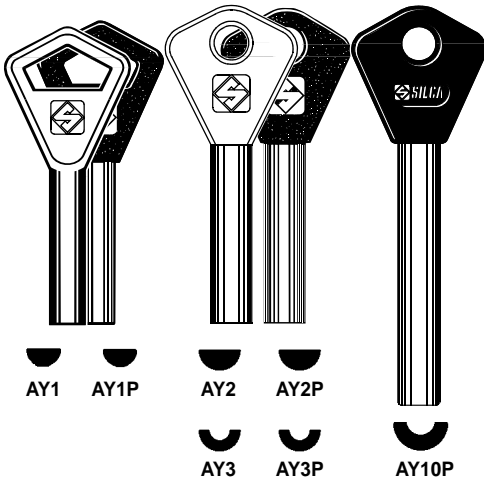

D708708ZB

Code attachment for ABLOY keys
Dispositivo a codice per chiavi ABLOY
Code-Vorrichtung für ABLOY Schlüssel
Dispositif à code pour clés ABLOY
Dispositivo a código para llaves ABLOY

D705040ZB

Cutter 06 (HSS)
Fresa 06 (HSS)
Fräser 06 (HSS)
Fraise 06 (HSS)
Fresa 06 (HSS)

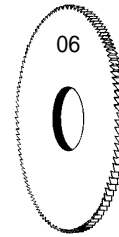

D706128ZB

Cutter 06W (carbide)
Fresa 06W (metal duro)
Fräser 06W (Hartmetall)
Fraise 06W (au carbure)
Fresa 06W (metal duro)

On Unocode 399 EVO it's advisable the use of hard metal cutter.

Per Unocode 399 EVO è consigliato l'uso della fresa in metallo duro.

Auf Unocode 399 EVO die Fräser aus Hart Metall ist empfehlenswert.

Avec Unocode 399 EVO il est conseillé l'usage de la fraise au carbure.

Con Unocode 399 EVO es recomendado el uso de la fesa en metal duro.



UNOCODE 399 EVO



PER:
FOR:

ABUS (D)

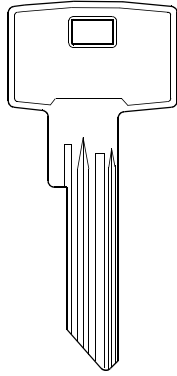

XY14
V14
Y14

CARD 2658
SN 3771

PFAFFENHAIN (D)

OPTIONAL

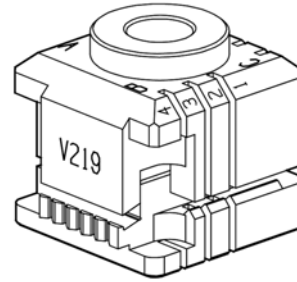

D739764ZB

Clamp V219
Morsetto V219
Spannbacken V219
Étau V219
Mordaza V219

PER:
FOR:

ANCHOR LÅS (S)

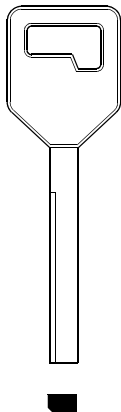

OPTIONAL

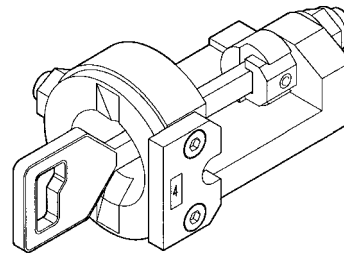

D708275ZB

Code attachment for ANCHOR LÅS keys
Dispositivo a codice per chiavi ANCHOR LÅS
Code-Vorrichtung für ANCHOR LÅS Schlüssel
Dispositif à code pour clés ANCHOR LÅS
Dispositivo a código para llaves ANCHOR LÅS

PER:
FOR:

ASSA (S) (+ various...)

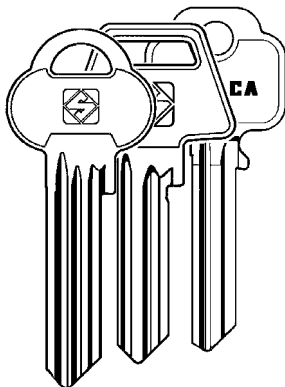

6-7 PIN KEYS

(D-12, DP, CLIQ)

OPTIONAL



OPTIONAL



OPTICAL READER
LETTORE OTTICO

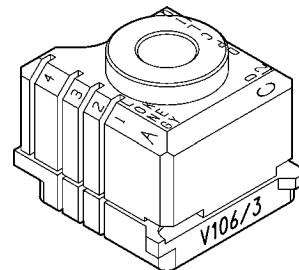

D736732ZB

V106/3 clamp for ASSA type keys (long keys, D-12*, DP, CLIQ)
Morsetto V106/3 per chiavi tipo ASSA (chiavi lunghe, D-12*, DP, CLIQ)
Spannbacke V106/3 für ASSA Schlüsseltyp (lange Schlüssel, D-12*, DP, CLIQ)
Étau V106/3 pour clés type ASSA (clés longues, D-12, DP, CLIQ)
Mordaza V106/3 para llaves de tipo ASSA (llaves largas, D-12*, DP, CLIQ)

*D-12: Key duplicable by code only
*D-12: Chiave duplicabile solo a codice
*D-12: Kopierenschlüssel nur zur Code
*D-12: Clé à copier uniquement par code
*D-12: Llave duplicable sólo a código



UNOCODE 399 EVO



PER:
FOR: **AVA CHUBB (S)**

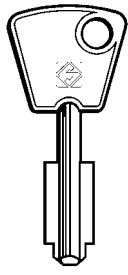

ACH

ANCHOR (S)

OPTIONAL

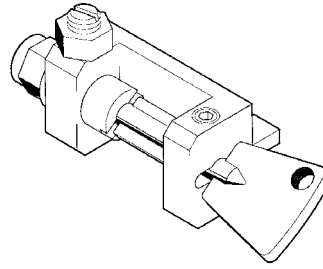

D710378ZB

*ACH adaptor
Adattatore ACH
ACH Adapter
Adaptateur ACH
Adaptadores ACH*



D702837ZB

*Cutter 05 (HSS)
Fresa 05 (HSS)
Fräser 05 (HSS)
Fraise 05 (HSS)
Fresa 05 (HSS)*

D705633ZB

*Cutter 05 (hard metal)
Fresa 05 (metal duro)
Fräser 05 (Hartmetall)
Fraise 05 (au carbure)
Fresa 05 (metal duro)*

On Unocode 399 EVO it's advisable the use of hard metal cutter.

Per Unocode 399 EVO è consigliato l'uso della fresa in metallo duro.

Auf Unocode 399 EVO die Fräser aus Hart Metall ist empfehlenswert.

Avec Unocode 399 EVO il est conseillé l'usage de la fraise au carbure.

Con Unocode 399 EVO es recomendado el uso de la fesa en metal duro.

PER:
FOR: **BILOCK (AUS)**

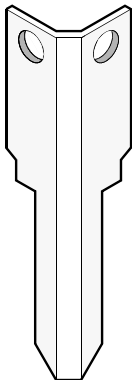

OPTIONAL

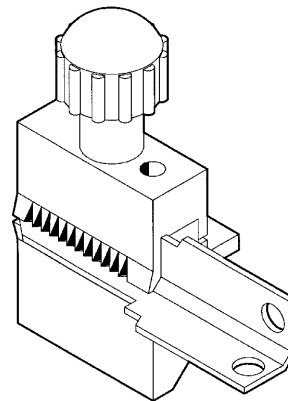

D711704ZB

*Adaptor for BILOCK keys
Set adattatore per chiavi BILOCK
Adapter für BILOCK Schlüssel
Adaptateur pour clés BILOCK
Adaptador para llaves BILOCK*

PER:
FOR: **BKS (D)**

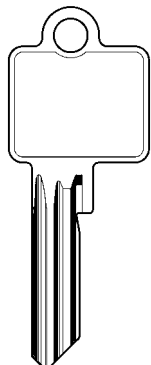

OPTIONAL

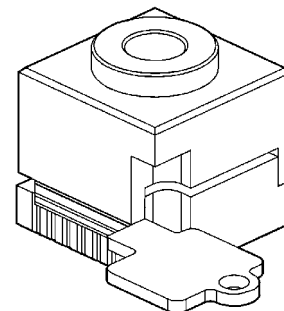

D731822ZB

*Clamp V211 for BKS type keys
Morsetto V211 per chiavi tipo BKS
Spannbacke V211 für BKS Schlüsseltyp
Etau V211 pour clés type BKS
Mordaza V211 para llaves de tipo BKS*



UNOCODE 399 EVO



PER:
FOR: **CHRYSLER (USA)**

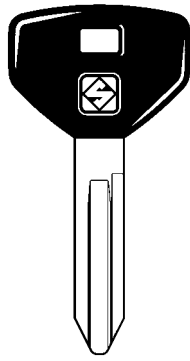

CY19P

OPTIONAL



D709576ZB
Pair of shims
Coppia spessori
Passtücke
Jeu de cales
Par de chapas de espesor

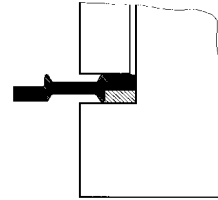
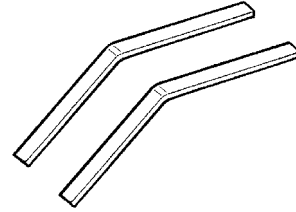

PER:
FOR: **CISA (I)**

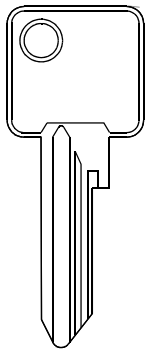

ABUS (D)

OPTIONAL



System protected by a password issued by Silca on receipt of authorization.
Sistema protetto da Password rilasciata da Silca a fronte di autorizzazione.
System geschützt durch von Silca geliefertes Password auf Genehmigung.
Système protégé par un Password qui est émis par Silca sur demande d'émission.
Sistema protegido por Password que expide Silca contra autorización.

D735434ZB
Clamp V103 for SP/TSP type keys
Morsetto V103 per chiavi tipo SP/TSP
Spannbacke V103 für SP/TSP Schlüsseltyp
Etau V103 pour clés type SP/TSP
Mordaza V103 para llaves de tipo SP/TSP

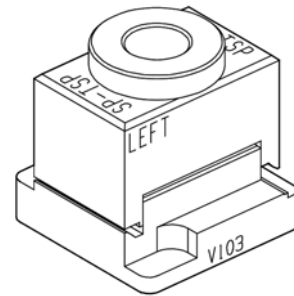

PER:
FOR: **CITROËN (F)**

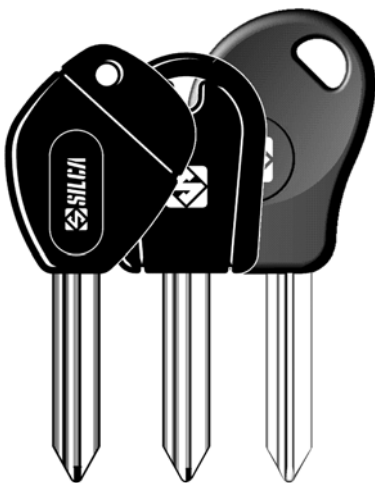

VALEO - SIMPLEX (F)

OPTIONAL

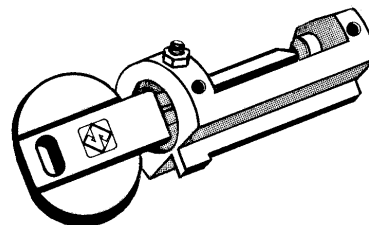

D708040ZB
Code adaptor for SIMPLEX
Adattatore a codice per chiavi SIMPLEX
Code-Adapter für SIMPLEX Schlüssel
Adaptateur à code pour clés SIMPLEX
Adaptador a código para llaves SIMPLEX



UNOCODE 399 EVO



PER:
FOR:

DOM (D)

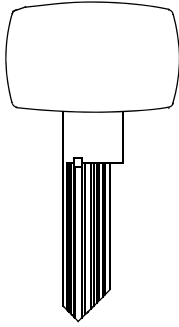

RS8
(Profil 134-135-135b-147-148)

OPTIONAL



D741046ZB

V216 clamp for DOM RS8 type keys
Morsetto V216 per chiavi tipo DOM RS8
Spannbacke V216 für DOM RS8 Schlüsseltyp
Étau V216 pour clés type DOM RS8
Mordaza V216 para llaves de tipo DOM RS8

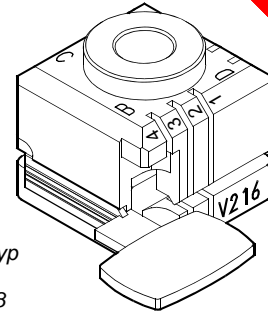

This accessory code has been updated from D735896ZB to D741046ZB.
Il codice di questo accessorio è stato aggiornato da D735896ZB a D741046ZB.
Der Kode von diesem Zubehör wurde von D735896ZB bis zum D741046ZB aktualisiert.
Le code de cet accessoire a été mis à jour de D735896ZB à D741046ZB.
El código de este accesorio ha sido actualizado de D735896ZB a D741046ZB.

PER:
FOR:

ESETY (I)

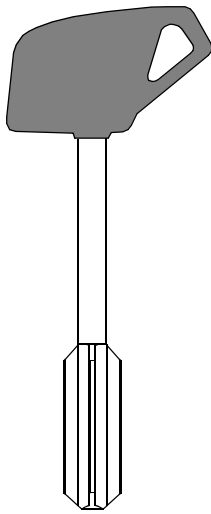

Omega

OPTIONAL

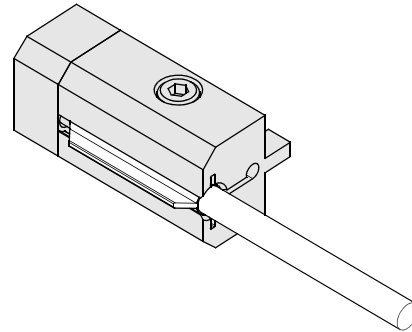

D724330ZB

B14 - Adapter for Omega keys
B14 - Adattatore per chiavi Omega
B14 - Adapter für Omega Schlüssel
B14 - Adaptateur pour clés Omega
B14 - Adaptador para llaves Omega

PER:
FOR:

FORD (EU)

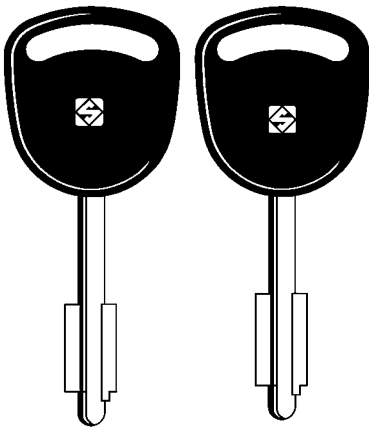

FO19P

FO20P

CHUBB (GB)

OPTIONAL

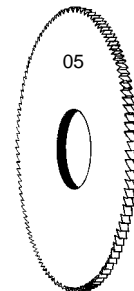
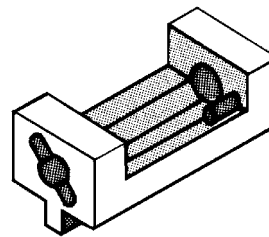

D706127ZB

Adaptor for FO19P-FO20P keys
Adattatore per chiavi FO19P-FO20P
Adapter für FO19P-FO20P Schlüssel
Adaptateur pour clés FO19P-FO20P
Adaptador para llaves FO19P-FO20P



UNOCODE 399 EVO



PER:
FOR:

FORD (EU+USA)

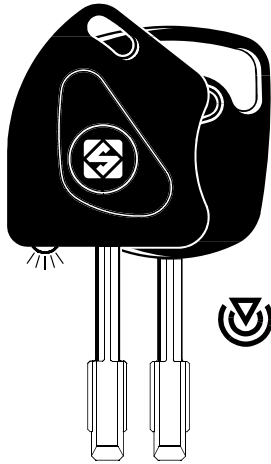

FO21T3L FO21T3 FO21PL

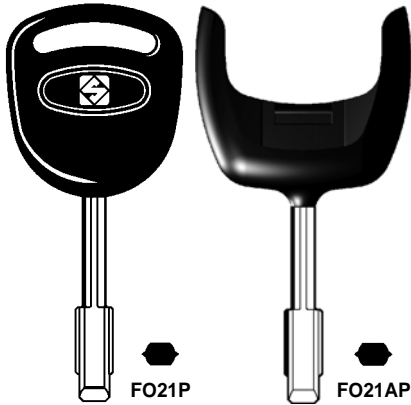

FO21P

FO21AP

IMPORTANT!

KEY BLANK TO BE APPLIED TO THE ORIGINAL REMOTE CONTROL (THE REMOTE CONTROL INCLUDES THE TRANSPONDER CHIP)

TIBBE (D)
VALEO (F)

OPTIONAL

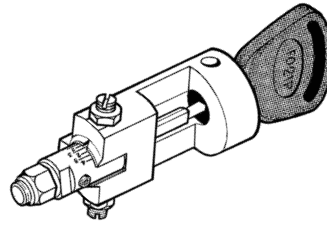

D708704ZB

Code attachment
Dispositivo a codice
Code-Vorrichtung
Dispositif à code
Dispositivo a código

D705040ZB

Cutter 06 (HSS)
Fresa 06 (HSS)
Fräser 06 (HSS)
Fraise 06 (HSS)
Fresa 06 (HSS)



D706128ZB

Cutter 06W (carbide)
Fresa 06W (metal duro)
Fräser 06W (Hartmetall)
Fraise 06W (au carbure)
Fresa 06W (metal duro)

On Unocode 399 EVO it's advisable the use of hard metal cutter.

Per Unocode 399 EVO è consigliato l'uso della fresa in metallo duro.

Auf Unocode 399 EVO die Fräser aus Hart Metall ist empfehlenswert.

Avec Unocode 399 EVO il est conseillé l'usage de la fraise au carbure.

Con Unocode 399 EVO es recomendado el uso de la fesa en metal duro.

PER:
FOR:

GEGE (A)

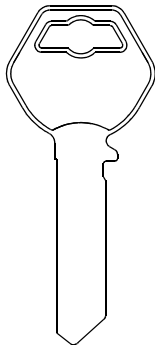

AP3000

OPTIONAL



D735433ZB

AP3000 jaw set
Set morsetto AP3000
AP3000 Spannbacken
Etau AP3000
Mordaza AP3000

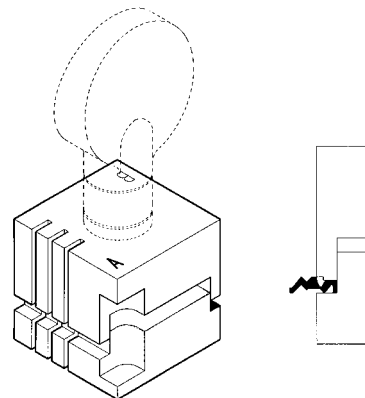

UNOCODE 399 EVO



PER:
FOR: **HYUNDAI (J)**



OPTIONAL

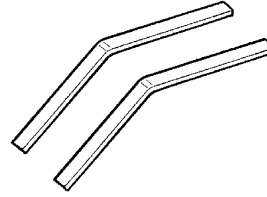

D709576ZB
Pair of shims
Coppia spessori
Passtücke
Jeu de cales
Par de chapas de espesor

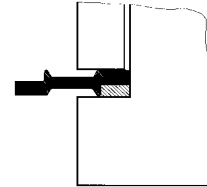

PER:
FOR: **JAGUAR (GB)**

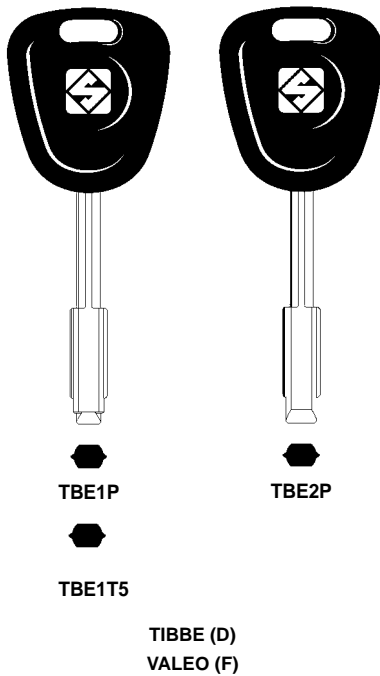

OPTIONAL

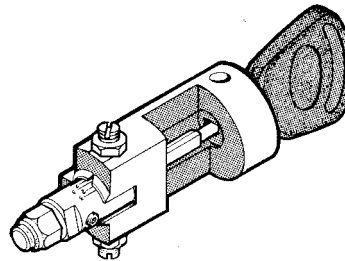

D708710ZB
Code attachment for TBE1P-TBE2P keys
Dispositivo a codice per chiavi TBE1P-TBE2P
Code-Vorrichtung für TBE1P-TBE2P Schlüssel
Dispositif à code pour clés TBE1P-TBE2P
Dispositivo a código para llaves TBE1P-TBE2P



D705040ZB
Cutter 06 (HSS)
Fresa 06 (HSS)
Fräser 06 (HSS)
Fraise 06 (HSS)
Fresa 06 (HSS)

On Unocode 399 EVO it's advisable the use of hard metal cutter.

Per Unocode 399 EVO è consigliato l'uso della fresa in metallo duro.

Auf Unocode 399 EVO die Fräser aus Hart Metall ist empfehlenswert.

Avec Unocode 399 EVO il est conseillé l'usage de la fraise au carbure.

Con Unocode 399 EVO es recomendado el uso de la fesa en metal duro.

D706128ZB
Cutter 06W (carbide)
Fresa 06W (metal duro)
Fräser 06W (Hartmetall)
Fraise 06W (au carbure)
Fresa 06W (metal duro)

PER:
FOR: **MEDECO (USA)**

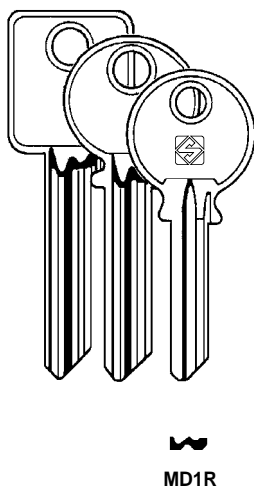

OPTIONAL

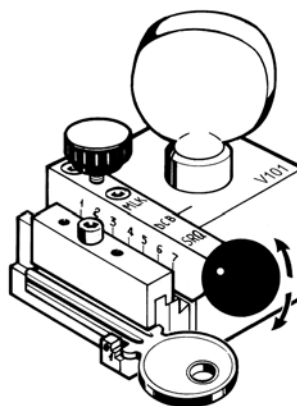

D707546ZB
Code device for MEDECO keys
Dispositivo a codice per chiavi MEDECO
Code-Vorrichtung für MEDECO Schlüssel
Dispositif à code pour clés MEDECO
Dispositivo a código para llaves MEDECO

D702851ZB

Cutter
Fresa
Fräser
Fraise
Fresa



UNOCODE 399 EVO



PER:
FOR:

MIWA (J)

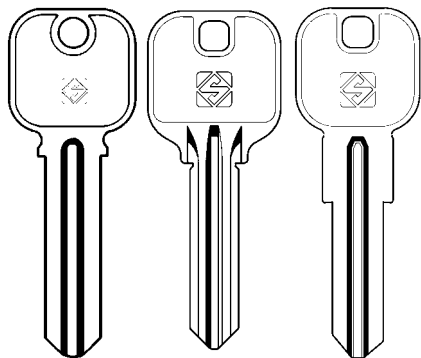

MIW1



MIW3



MIW7



MIW2



MIW12

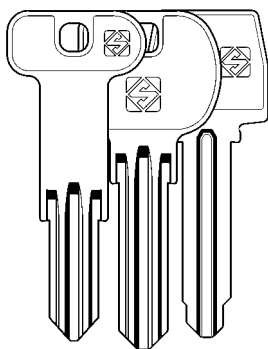

MIW4



MIW5



MIW6



MIW13

OPTIONAL

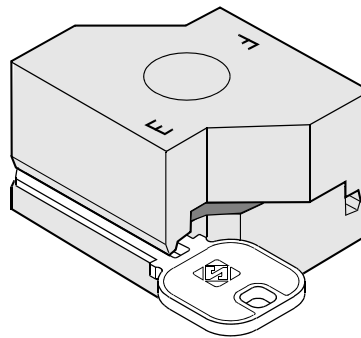

D735432ZB

Clamp for MIWA keys
Morsetto per chiavi MIWA
Spannbacken für MIWA Schlüssel
Étau pour clés MIWA
Mordaza para llaves MIWA

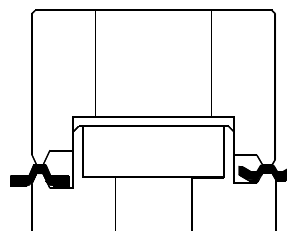

PER:
FOR:

PORSCHE (D)

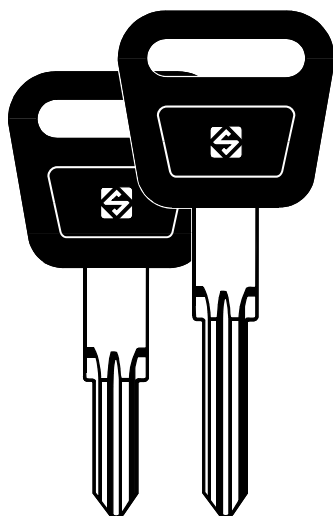

HU42P



HU45P

HUF (D)

OPTIONAL

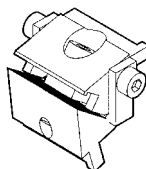

D711151ZB

Adaptor for HU42P-HU45P keys
Adattatori per chiavi HU42P-HU45P
Adapter für HU42P-HU45P Schlüssel
Adaptateur pour clés HU42P-HU45P
Adaptador para llaves HU42P-HU45P



UNOCODE 399 EVO



PER:
FOR:

RENAULT (F)

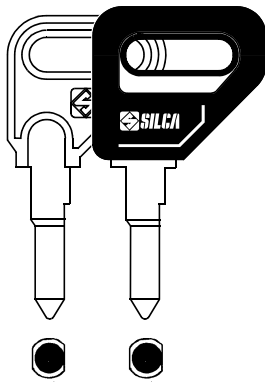

NE33S NE33SP

VALEO - NEIMAN (F)

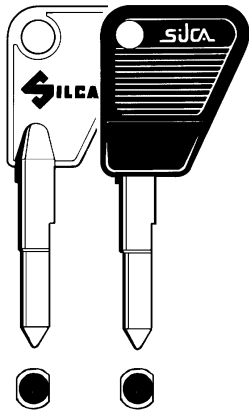

VAC64S VAC64SP

VACHETTE (F)

OPTIONAL

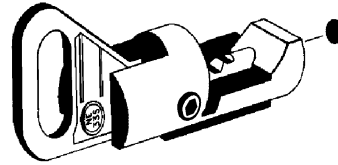

D706019ZB

*Adaptor for NE33S-VAC64S keys
Adattatore per chiavi NE33S-VAC64S
Adapter für NE33S-VAC64S Schlüssel
Adaptateur pour clés NE33S-VAC64S
Adaptador para llaves NE33S-VAC64S*

PER:
FOR:

WINKHAUS (D)

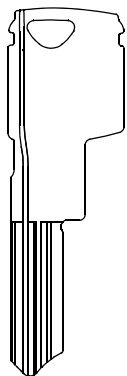

RPE - RPS

OPTIONAL



CARD 3362
SN 4262

D740056ZB

*Clamp V220
Morsetto V220
Spannbacken V220
Etau V220
Mordaza V220*

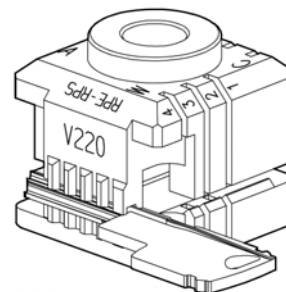

UNOCODE 399 EVO



PER:
FOR:



UNOCODE 399 Unocode 399 Evo

OPTIONAL



"V1" rotating clamp

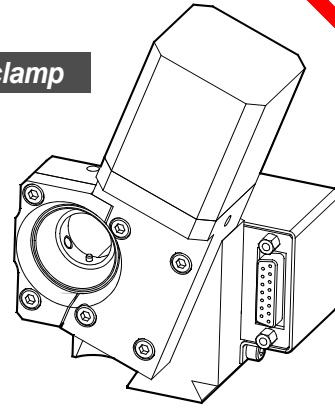

D722893ZB

"V1" rotating clamp
Morsetto girevole "V1"
Drehbarer Spannbacken "V1"
Étau pivotant "V1"
Mordaza giratoria "V1"

KIT TOOLS FOR "V1" ROTATING CLAMP

PER:
FOR:

ABLOY (S)

OPTIONAL

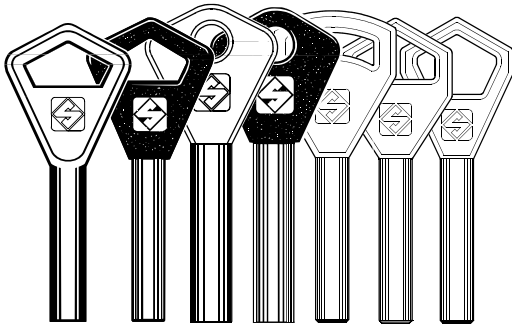

AY1 AY1P AY2 AY2P AY11 AY12 AY16
AY3 AY3P

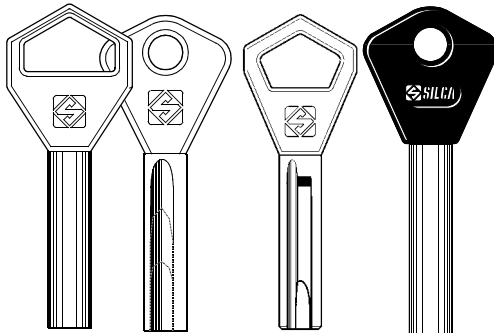

AY13 AY14 AY18 AY21
AY15 AY20 AY23 AY10P
AY17

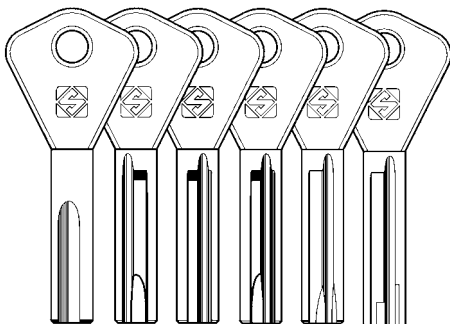

AY24 AY25 AY26 AY27 AY28 AY29

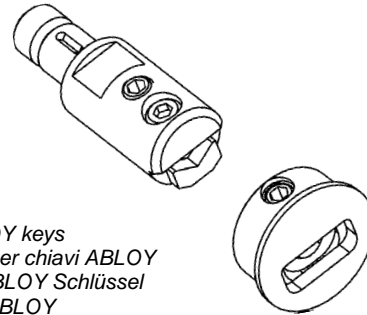

D723053ZB

Kit tools for ABLOY keys
Set contropunta per chiavi ABLOY
Werkzeuge für ABLOY Schlüssel
Outils pour clés ABLOY
Utiles para llaves ABLOY

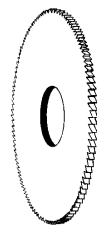

D705040ZB

Cutter 06 (HSS)
Fresa 06 (HSS)
Fräser 06 (HSS)
Fraise 06 (HSS)
Fresa 06 (HSS)

D706128ZB

Cutter 06W (carbide)
Fresa 06W (metal duro)
Fräser 06W (Hartmetall)
Fraise 06W (au carbure)
Fresa 06W (metal duro)

On Unocode 399 EVO it's advisable the use of hard metal cutter.

Per Unocode 399 EVO è consigliato l'uso della fresa in metallo duro.

Auf Unocode 399 EVO die Fräser aus Hart Metall ist empfehlenswert.

Avec Unocode 399 EVO il est conseillé l'usage de la fraise au carbure.

Con Unocode 399 EVO es recomendado el uso de la fesa en metal duro.



UNOCODE 399 EVO



PER:
FOR:

ABUS (D)

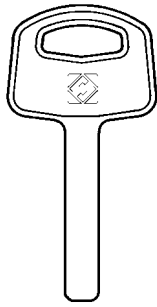

AB32

OPTIONAL

CODE

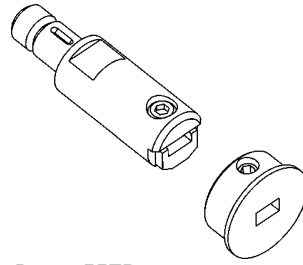

D723055ZB

Kit tools for AB32 keys
Set contropunta per chiavi AB32
Werkzeuge für AB32 Schlüssel
Outils pour clés AB32
Útiles para llaves AB32

D705040ZB

Cutter 06 (HSS)
Fresa 06 (HSS)
Fräser 06 (HSS)
Fraise 06 (HSS)
Fresa 06 (HSS)

D706128ZB

Cutter 06W (carbide)
Fresa 06W (metal duro)
Fräser 06W (Hartmetall)
Fraise 06W (au carbure)
Fresa 06W (metal duro)

On Unocode 399 EVO it's advisable the use of hard metal cutter.

Per Unocode 399 EVO è consigliato l'uso della fresa in metallo duro.

Auf Unocode 399 EVO die Fräser aus Hart Metall ist empfehlenswert.

Avec Unocode 399 EVO il est conseillé l'usage de la fraise au carbure.

Con Unocode 399 EVO es recomendado el uso de la fesa en metal duro.

PER:
FOR:

ABUS (D)



AB38P

AB60P

IMPORTANT!

Patented key, please contact Silca for information.

Chiave brevettata, rivolgersi a Silca per informazioni.

Patentierter Schlüssel, Bitte, für Informationen an Silca sich wenden.

Clé brevetée, contacter Silca pour information.

Llave patentada, contactar Silca para informaciones.

OPTIONAL

CODE

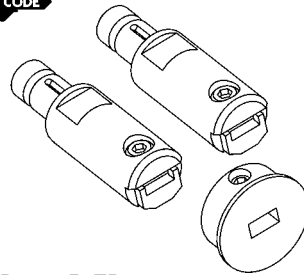

D723057ZB

Kit tools for AB38P-AB60P keys
Set contropunta per chiavi AB38P-AB60P
Werkzeuge für AB38P-AB60P Schlüssel
Outils pour clés AB38P-AB60P
Útiles para llaves AB38P-AB60P

On Unocode 399 EVO it's advisable the use of hard metal cutter.

Per Unocode 399 EVO è consigliato l'uso della fresa in metallo duro.

Auf Unocode 399 EVO die Fräser aus Hart Metall ist empfehlenswert.

Avec Unocode 399 EVO il est conseillé l'usage de la fraise au carbure.

Con Unocode 399 EVO es recomendado el uso de la fesa en metal duro.

AB60P

D712450ZB

Cutter SG13 (HSS)
Fresa SG13 (HSS)
Fräser SG13 (HSS)
Fraise SG13 (HSS)
Fresa SG13 (HSS)

D723158ZB

Cutter SG13W (carbide)
Fresa SG13W (metal duro)
Fräser SG13W (Hartmetall)
Fraise SG13W (au carbure)
Fresa SG13W (metal duro)

AB38P

D705040ZB

Cutter 06 (HSS)
Fresa 06 (HSS)
Fräser 06 (HSS)
Fraise 06 (HSS)
Fresa 06 (HSS)

D706128ZB

Cutter 06W (carbide)
Fresa 06W (metal duro)
Fräser 06W (Hartmetall)
Fraise 06W (au carbure)
Fresa 06W (metal duro)

PER:
FOR:

AVA CHUBB (S)

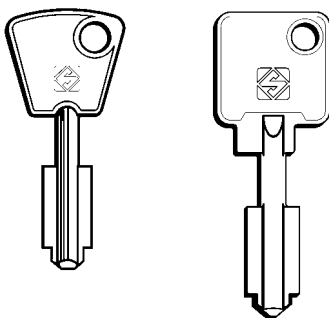

ACH

5ACH4

OPTIONAL

CODE

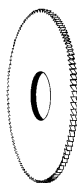

D723043ZB

Kit tools for AVA CHUBB keys
Set contropunta per chiavi AVA CHUBB
Werkzeuge für AVA CHUBB Schlüssel
Outils pour clés AVA CHUBB
Útiles para llaves AVA CHUBB

D702837ZB

Cutter 05 (HSS)
Fresa 05 (HSS)
Fräser 05 (HSS)
Fraise 05 (HSS)
Fresa 05 (HSS)

D705633ZB

Cutter 05W (carbide)
Fresa 05W (metal duro)
Fräser 05W (Hartmetall)
Fraise 05W (au carbure)
Fresa 05W (metal duro)

On Unocode 399 EVO it's advisable the use of hard metal cutter.

Per Unocode 399 EVO è consigliato l'uso della fresa in metallo duro.

Auf Unocode 399 EVO die Fräser aus Hart Metall ist empfehlenswert.

Avec Unocode 399 EVO il est conseillé l'usage de la fraise au carbure.

Con Unocode 399 EVO es recomendado el uso de la fesa en metal duro.



UNOCODE 399 EVO



PER:
FOR:

ANCHOR LÅS (S)

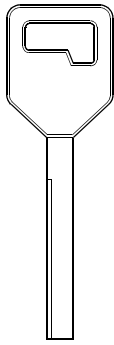

OPTIONAL



D723049ZB

Kit tools for ANCHOR-LÅS keys
Set contropunta per chiavi ANCHOR-LÅS
Werkzeuge für ANCHOR-LÅS Schlüssel
Outils pour clés ANCHOR-LÅS
Útiles para llaves ANCHOR-LÅS

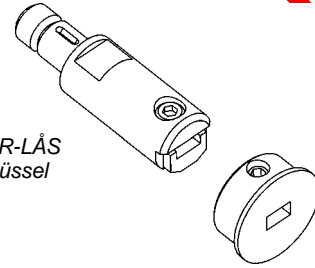

D705040ZB

Cutter 06 (HSS)
Fresa 06 (HSS)
Fräser 06 (HSS)
Fraise 06 (HSS)
Fresa 06 (HSS)



D706128ZB

Cutter 06W (carbide)
Fresa 06W (metallo duro)
Fräser 06W (Hartmetall)
Fraise 06W (au carbure)
Fresa 06W (metal duro)

On Unocode 399 EVO it's advisable the use of hard metal cutter.
Per Unocode 399 EVO è consigliato l'uso della fresa in metallo duro.
Auf Unocode 399 EVO die Fräser aus Hart Metall ist empfehlenswert.
Avec Unocode 399 EVO il est conseillé l'usage de la fraise au carbure.
Con Unocode 399 EVO es recomendado el uso de la fesa en metal duro.

PER:
FOR:

CHUBB (GB)

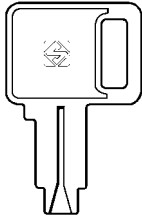

CHU5

OPTIONAL



D723160ZB

Kit tools for CHU5 keys
Set contropunta per chiavi CHU5
Werkzeuge für CHU5 Schlüssel
Outils pour clés CHU5
Útiles para llaves CHU5

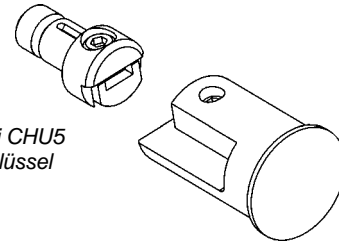

D702837ZB

Cutter 05 (HSS)
Fresa 05 (HSS)
Fräser 05 (HSS)
Fraise 05 (HSS)
Fresa 05 (HSS)

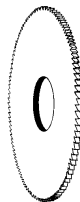

D705633ZB

Cutter 05W (carbide)
Fresa 05W (metallo duro)
Fräser 05W (Hartmetall)
Fraise 05W (au carbure)
Fresa 05W (metal duro)

On Unocode 399 EVO it's advisable the use of hard metal cutter.
Per Unocode 399 EVO è consigliato l'uso della fresa in metallo duro.
Auf Unocode 399 EVO die Fräser aus Hart Metall ist empfehlenswert.
Avec Unocode 399 EVO il est conseillé l'usage de la fraise au carbure.
Con Unocode 399 EVO es recomendado el uso de la fesa en metal duro.

PER:
FOR:

FORD (EU)

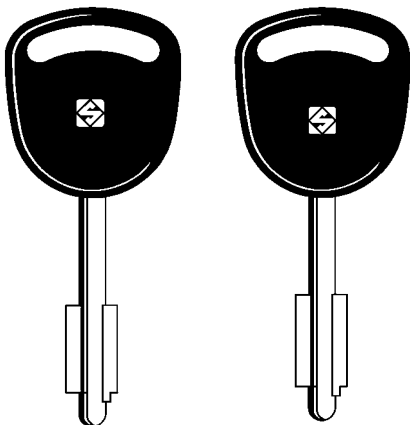

FO19P

FO20P

CHUBB (GB)

OPTIONAL



D723051ZB

Kit tools for FO19P-FO20P keys
Set contropunta per chiavi FO19P-FO20P
Werkzeuge für FO19P-FO20P Schlüssel
Outils pour clés FO19P-FO20P
Útiles para llaves FO19P-FO20P

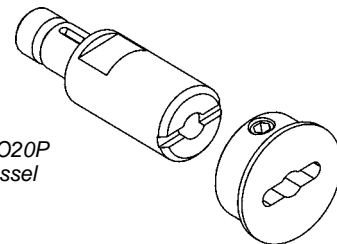

D702837ZB

Cutter 05 (HSS)
Fresa 05 (HSS)
Fräser 05 (HSS)
Fraise 05 (HSS)
Fresa 05 (HSS)



D705633ZB

Cutter 05W (carbide)
Fresa 05W (metallo duro)
Fräser 05W (Hartmetall)
Fraise 05W (au carbure)
Fresa 05W (metal duro)

On Unocode 399 EVO it's advisable the use of hard metal cutter.
Per Unocode 399 EVO è consigliato l'uso della fresa in metallo duro.
Auf Unocode 399 EVO die Fräser aus Hart Metall ist empfehlenswert.
Avec Unocode 399 EVO il est conseillé l'usage de la fraise au carbure.
Con Unocode 399 EVO es recomendado el uso de la fesa en metal duro.



UNOCODE 399 EVO

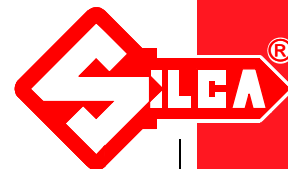

PER:
FOR:

FORD (EU+USA)

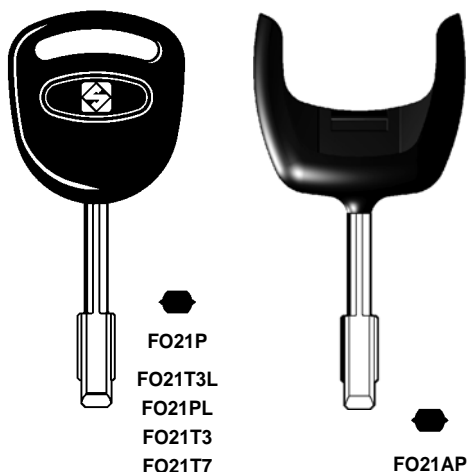

FO21P
FO21T3L
FO21PL
FO21T3
FO21T7

FO21AP

TIBBE (D)
VALEO (F)

OPTIONAL



D723059ZB

Kit tools for FO21P keys
Set contropunta per chiavi FO21P
Werkzeuge für FO21P Schlüssel
Outils pour clés FO21P
Útiles para llaves FO21P

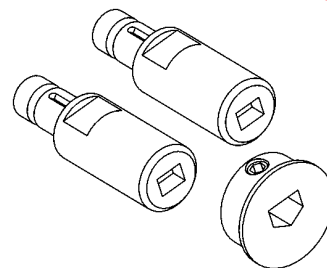

D705040ZB

Cutter 06 (HSS)
Fresa 06 (HSS)
Fräser 06 (HSS)
Fraise 06 (HSS)
Fresa 06 (HSS)

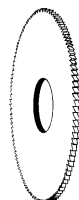

D706128ZB

Cutter 06W (carbide)
Fresa 06W (metal duro)
Fräser 06W (Hartmetall)
Fraise 06W (au carbure)
Fresa 06W (metal duro)

On Unocode 399 EVO it's advisable the use of hard metal cutter.
Per Unocode 399 EVO è consigliato l'uso della fresa in metallo duro.
Auf Unocode 399 EVO die Fräser aus Hart Metall ist empfehlenswert.
Avec Unocode 399 EVO il est conseillé l'usage de la fraise au carbure.
Con Unocode 399 EVO es recomendado el uso de la fesa en metal duro.

PER:
FOR:

JAGUAR (GB)

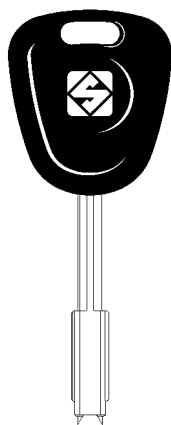

TBE1P
TBE2P
TBE1T5

TIBBE (D)
VALEO (F)

OPTIONAL



D723059ZB

Kit tools for TBE1P-TBE2P keys
Set contropunta per chiavi TBE1P-TBE2P
Werkzeuge für TBE1P-TBE2P Schlüssel
Outils pour clés TBE1P-TBE2P
Útiles para llaves TBE1P-TBE2P

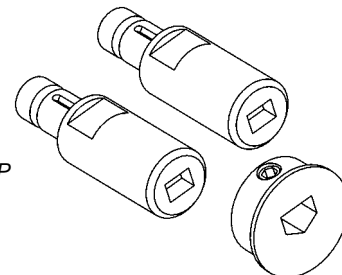

D705040ZB

Cutter 06 (HSS)
Fresa 06 (HSS)
Fräser 06 (HSS)
Fraise 06 (HSS)
Fresa 06 (HSS)



D706128ZB

Cutter 06W (carbide)
Fresa 06W (metal duro)
Fräser 06W (Hartmetall)
Fraise 06W (au carbure)
Fresa 06W (metal duro)

On Unocode 399 EVO it's advisable the use of hard metal cutter.
Per Unocode 399 EVO è consigliato l'uso della fresa in metallo duro.
Auf Unocode 399 EVO die Fräser aus Hart Metall ist empfehlenswert.
Avec Unocode 399 EVO il est conseillé l'usage de la fraise au carbure.
Con Unocode 399 EVO es recomendado el uso de la fesa en metal duro.

PER:
FOR:

LUMA (E)

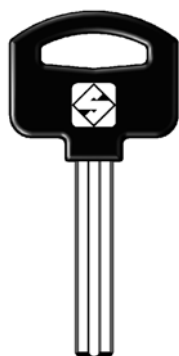

LM5P

OPTIONAL



D723045ZB

Kit tools for LM5P keys
Set contropunta per chiavi LM5P
Werkzeuge für LM5P Schlüssel
Outils pour clés LM5P
Útiles para llaves LM5P

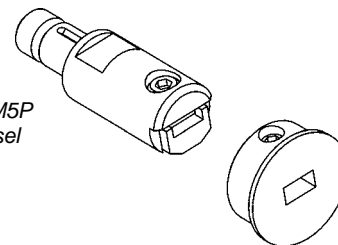

D705040ZB

Cutter 06 (HSS)
Fresa 06 (HSS)
Fräser 06 (HSS)
Fraise 06 (HSS)
Fresa 06 (HSS)

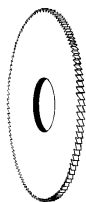

D706128ZB

Cutter 06W (carbide)
Fresa 06W (metal duro)
Fräser 06W (Hartmetall)
Fraise 06W (au carbure)
Fresa 06W (metal duro)

On Unocode 399 EVO it's advisable the use of hard metal cutter.
Per Unocode 399 EVO è consigliato l'uso della fresa in metallo duro.
Auf Unocode 399 EVO die Fräser aus Hart Metall ist empfehlenswert.
Avec Unocode 399 EVO il est conseillé l'usage de la fraise au carbure.
Con Unocode 399 EVO es recomendado el uso de la fesa en metal duro.



UNOCODE 399 EVO



PER:
FOR:



UNOCODE 399 Unocode 399 Evo

Cutting flat keys
Cifratura chiavi piatte
Fräsen von Flachschlüsseln
Taillage de clés plates
Duplicación de llaves planas

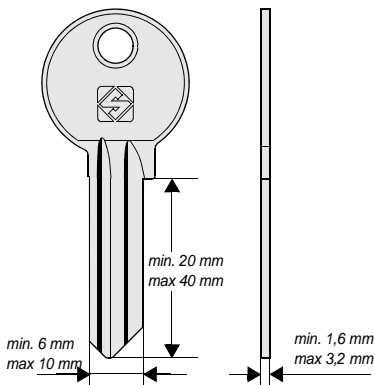

IMPORTANT NOTE:
in order to use the automatic key feeder with keys characterized by dimensions closed to the min./max indicated please contact Silca Technical Assistance Dept.

OPTIONAL



Automatic key feeder - Set caricatore di chiavi piatte - Grundzuführung
Set Alimentateur de clés plates - Alimentador de llaves planas

D717228ZB

Automatic key feeder
Set caricatore di chiavi piatte
Grundzuführung
Alimentateur de clés plates
Alimentador de llaves planas

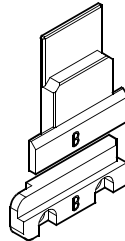

D721322ZB

"B side" jaw set
Set ganasce "lato B"
Backen "Seite B"
Mâchoires "côté B"
Quijadas "lado B"

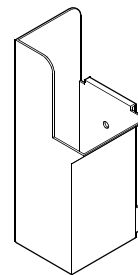
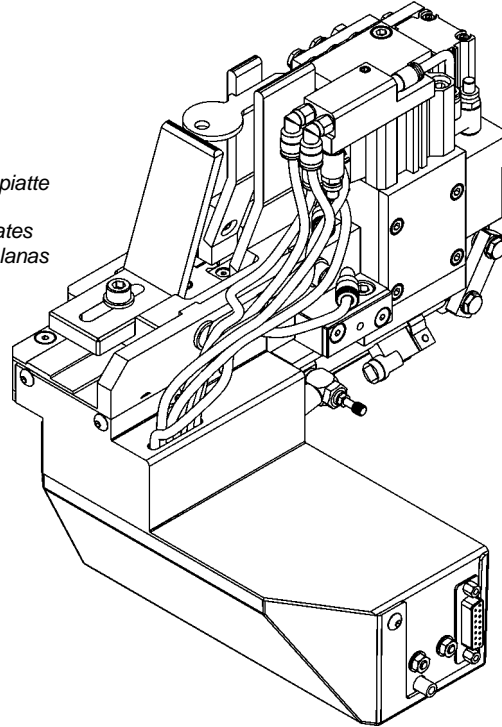

for Unocode 399

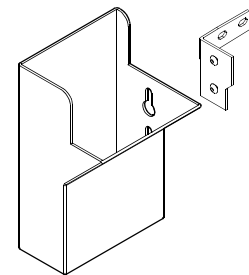

for Unocode 399 EVO

TECHNICAL DATA - CARATTERISTICHE TECNICHE - TECHNISCHE DATEN - CARACTERISTIQUES TECHNIQUES - DATOS TÉCNICOS

Working - Funzionamento - Funktionsweise Fonctionnement - Funcionamiento	by compressed air* - collegamento ad aria compressa* - mit Druckluft* - avec air comprimé* - con aire comprimido* 0,5 - 0,6 MPa					
Dimensions - Dimensioni - Abmessungen Encombrement - Dimensiones	width - larghezza - Breite larghezza - anchura	230 mm	height - altezza - Höhe hauteur - altura	220 mm	depth - profondità - Tiefe profondeur - profundidad	200 mm
Mass - Massa - Gewicht - Poids - Masa	Kg. 5,5					

* Not supplied - Non in dotazione - Nicht Zubehör - Non fourni - No en el equipamiento



UNOCODE 399 EVO

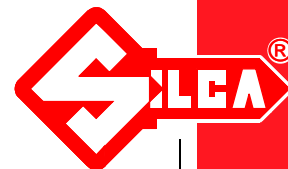

PER: **UNOCODE 399**

FOR: **UNOCODE 399**

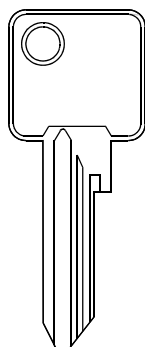



 "SP" "TSP"
 ABUS

OPTIONAL

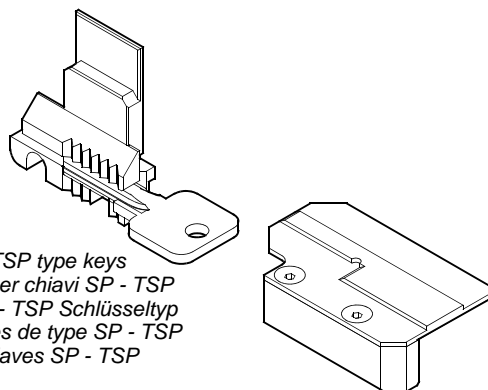

D723136ZB

Tool set for SP - TSP type keys
 Set attrezzatura per chiavi SP - TSP
 Werkzeug für SP - TSP Schlüsseltyp
 Set outils pour clés de type SP - TSP
 Accesorios para llaves SP - TSP

To fit on automatic key feeder
 Da applicare al caricatore di chiavi
 Auf Grundzuführung zu installieren
 A installer sur l'alimentateur de clés
 A instalarse en alimentador de llaves

PER: **UNOCODE 399**

FOR: **UNOCODE 399**

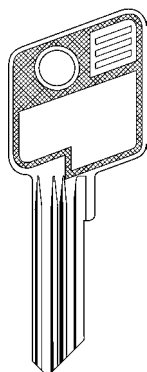

EVVA DPS

OPTIONAL

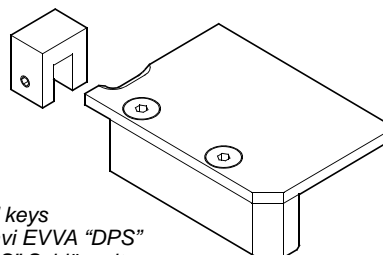

D723123ZB

Tool set for EVVA "DPS" keys
 Set attrezzatura per chiavi EVVA "DPS"
 Werkzeug für EVVA "DPS" Schlüsseltyp
 Set outils pour clés de type EVVA "DPS"
 Accesorios para llaves EVVA "DPS"

To fit on automatic key feeder
 Da applicare al caricatore di chiavi
 Auf Grundzuführung zu installieren
 A installer sur l'alimentateur de clés
 A instalarse en alimentador de llaves

PER:
FOR:



UNOCODE 399
Unocode 399 Evo

OPTIONAL

Swarf vacuum set

D722823ZB

Swarf vacuum set
 Set aspirazione trucioli
 Späneabsaugungssatz
 Ensemble d'aspiration des copeaux
 Conjunto aspiracion de virutas

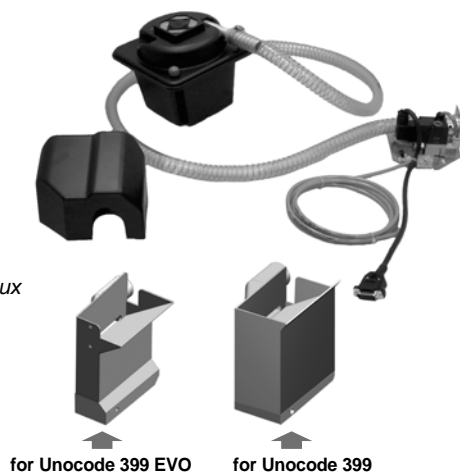

for Unocode 399 EVO

for Unocode 399



UNOCODE 399 EVO

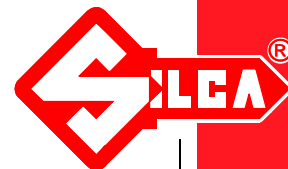

PER:
FOR:



Unocode 399 Evo

OPTIONAL

Swarf tray for vacuum system

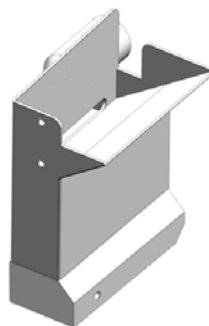

D735714ZB

*Swarf tray for vacuum system
Kit vaschetta in metallo per aspiratrucioli
Splitterschutz für für Späneabsaugung
Cuvette à copeaux pour kit d'aspiration
Cubeta virutas para aspiración*

