



Unocode 399 Evo

Operating manual



D434731XA

vers. 3.0



(c) 2011 SILCA S.p.A. - Vittorio Veneto

This manual is written by SILCA S.p.A.

All rights reserved. No part of this publication may be reproduced or used in any form or by any means (photocopying, microfilm or other) without the written permission of SILCA S.p.A.

Edition: april 2011

*Printed in Vittorio Veneto
by SILCA S.p.A.
via Podgora, 20 (Z.I.)
31029 VITTORIO VENETO (TV) - Italy*

IMPORTANT NOTE: *in compliance with current regulations relating to industrial property, we hereby state that the trade-marks or trade names mentioned in our documentation are the exclusive property of authorized manufacturers of locks and users.
Said trade-marks or trade names are nominated only for the purposes of information so that any lock for which our keys are made can be rapidly identified.*

INDEX

REFERENCE GUIDE	1
GENERAL	2
1 MACHINE DESCRIPTION	4
1.1 MAIN CHARACTERISTICS	4
1.2 SAFETY	5
1.3 MAIN WORKING PARTS	6
1.4 TECHNICAL DATA	7
1.5 ACCESSORIES PROVIDED	8
2 TRANSPORT	9
2.1 PACKING	9
2.2 UNPACKING	10
2.3 MACHINE HANDLING	10
3 MACHINE INSTALLATION AND PREPARATION	11
3.1 CHECKING FOR DAMAGE	11
3.2 ENVIRONMENTAL CONDITIONS	11
3.3 POSITIONING AND INSTALLATION	11
3.4 DESCRIPTION OF WORK STATION	12
3.5 GRAPHICS	12
4 "SET UP" AND USE OF THE MACHINE	13
4.1 USE OF THE CLAMP	13
4.2 CUTTING BY ELECTRIC CONTACT	15
4.3 IMPROPER USE OF ELECTRIC CONTACT	15
4.4 FITTING THE CLAMP TO THE MACHINE	16
4.5 CUTTER	16
4.6 CHANGING THE CUTTER	16
5 OPERATING GUIDE	17
5.1 INITIAL OPERATIONS	17
5.2 MACHINE KEYBOARD AND FUNCTION BUTTONS	18
5.3 COPY FROM ORIGINAL	19
5.4 COPY WITH ADJUSTMENTS	20
5.5 COPY FROM CUTTING CARD	23
5.5.1 SPECIAL CASES	32
5.5.2 LIMITED ACCESS TO DATA (PROTECTED SYSTEMS)	34
5.6 PC QUEUE	36
5.7 CODE MAKER	39
5.8 GAUGING	42
5.8.1 CALIBRATE JAWS	43
5.8.2 CALIBRATE CUTTERS	47
5.8.3 CALIBRATE ADAPTERS	47
5.9 MAINTENANCE	48
5.9.1 OPTIC READER TEST	48
5.9.2 MOTOR TESTS	48
5.9.3 DIGITAL INLETS TEST	48
5.9.4 DIGITAL OUTLETS TESTS	49
5.9.5 KEYPAD TEST	49
5.9.6 DISPLAY TEST	49
5.9.7 SERIAL PORT	50
5.9.8 MACHINE ZERO POINTS	50
5.9.9 PHOTOCELLS AND SENSORS REGULATION	53
5.10 OPTIONS	56
5.11 ENABLING	59
5.12 MESSAGES	60
5.12.1 ATTENTION MESSAGES	60
5.12.2 ERROR MESSAGES	62

	5.12.3 ALARM MESSAGES	63
	5.12.4 CODEMAKER MESSAGES	64
6	CLEANING	66
7	MAINTENANCE	67
	7.1 TROUBLE SHOOTING	67
	7.2 MAINTENANCE OPERATIONS	69
	7.3 CUTTER REPLACEMENT	69
	7.4 BELT REPLACEMENT AND TENSION ADJUSTMENT	70
	7.5 CHECKING AND/OR REPLACING FUSES	71
	7.6 ELECTRONIC CIRCUIT BOARD REPLACEMENT	72
	7.7 KEYBOARD/DISPLAY REPLACEMENT	73
	7.8 ACCESS TO BACK COMPARTMENT	74
	7.9 ACCESS TO BOTTOM COMPARTMENT	74
	7.10 SENSOR REPLACEMENT	75
	7.11 PHOTOCCELL REPLACEMENT	77
	7.12 BRUSH REPLACEMENT	78
	7.13 BATTERY REPLACEMENT	78
	7.14 WIN-TRANSFER PROGRAM	79
8	DISPOSING OF MACHINE	80
9	ASSISTANCE	81
	9.1 HOW TO REQUEST SERVICE	81

Appendix 1 - ELECTRICAL DIAGRAM I - VIII

Appendix 2 - DECLARATION COMPLIANCE

REFERENCE GUIDE

This manual has been produced to serve as a guide for users of the UNOCODE 399 EVO electronic key-cutting machine. Read it carefully; it is essential if you wish to operate your machine safely and efficiently.

CONSULTATION

The contents of the manual are divided into sections relating to:

• Machine description	Chapter	1
• Transport and installation	Chapters	2-3
• Regulation and use	Chapters	4-5-6
• Maintenance	Chapters	7-8-9

TECHNICAL TERMS

Common technical terms are used in this manual.

To assist those with little experience of keys and key-cutting, below is an illustration of the terms most frequently used.

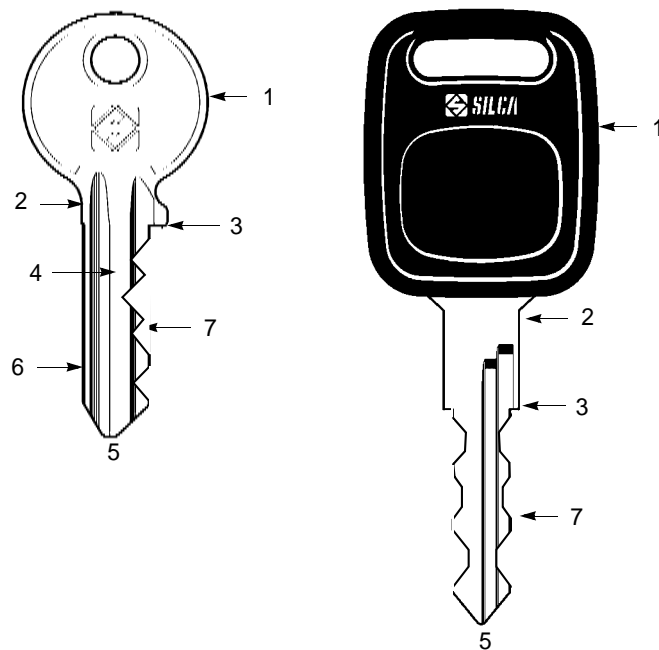


Fig. 1

- 1) Head
- 2) Rim
- 3) Stop
- 4) Stem
- 5) Tip
- 6) Back
- 7) Cuts

GENERAL

UNOCODE 399 EVO has been designed in compliance to the European Community normative (CE). From the design stage, risks for the operator have been eliminated in all areas: transport, regulation, cutting and maintenance.

Further risks have been eliminated by means of protective devices.

The materials used to manufacture this machine and all its components are not hazardous.

USE

UNOCODE 399 EVO is designed for cutting keys of ferrous materials: brass, silver nickel, etc.

It must be installed and used according to the instructions indicated by the manufacturer.

If the key-cutting machine is used differently or for purposes different from those described in this manual, the customer will forego any rights he may have over Silca S.p.A. Furthermore, unforeseen danger to the operator or any third parties may arise from incorrect use of the machine.

INSTRUCTIONS MANUAL

The instructions manual provided with the machine is essential to its proper use and to carry out the necessary maintenance.

We therefore recommend protecting the manual from damage in a safe sheltered place, easily to hand for quick consultation.

INCORRECT USE

Operator negligence resulting in improper use of this machine or failure of the operator to observe the instructions written in this manual. The manufacturer may decline all guarantees and responsibilities.

It is therefore essential to carefully read this operating manual.

IMPROPER USE OF ELECTRIC CONTACT

- **it is not permitted** to cut ultralite anodized **aluminium** keys, **plastic** keys or any keys with materials that do not have electrical conductivity by means of electric contact.
- **cuts cannot be repeated** on the same side of the key when electric contact cutting is used.

FURTHER RISKS

No further risks will arise when properly using the UNOCODE 399 EVO.

PROTECTION AND SAFETY PRECAUTIONS FOR THE OPERATOR

UNOCODE 399 EVO is entirely built in compliance to the Machine Directives. The operations for which it has been designed are easily carried out with no risk to the operator.

The adoption of general safety precautions and observation of the instructions provided by the manufacturer in this manual eliminate all human error, unless deliberate.

UNOCODE 399 EVO is designed with features which make it completely safe.

• **Power supply**

UNOCODE 399 EVO is supplied with electricity by means of a grounded plug and differential switch.

• **Pneumatic power**

With compressed air.

• **Start-up**

The machine is turned on by means of a master switch that is located on the Unocode's lower left back side.

• **Maintenance**

The operations to regulate, service, repair and clean the machine are structured in the simplest and safest way possible. Parts that the operator can dismount cannot be incorrectly replaced therefore avoiding any risks.

• **Machine identification**

The machine is provided with an identification label which includes the machine's serial number (fig. 2).

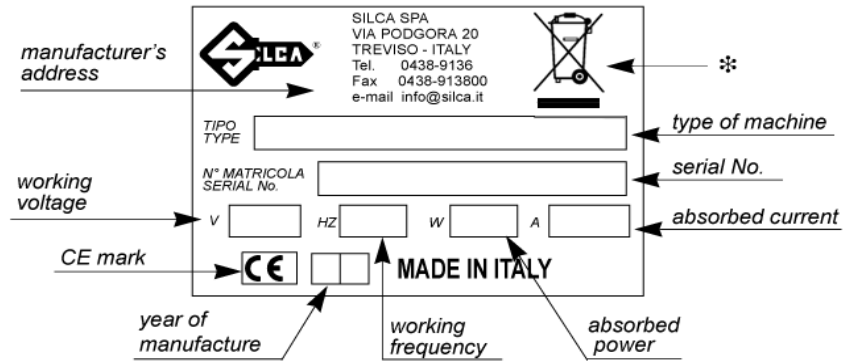


Fig. 2

(*) see chap.8 "DISPOSING OF MACHINE", page 80.

1 MACHINE DESCRIPTION

UNOCODE 399 EVO is an electronic machine operating on two axes (3rd axis optional) with controlled movement. Accurately studied, it adds a high degree of cutting precision to operating speed and ease of use.

UNOCODE can be used in 3 different ways:

- **entering the key code directly by means of the machine keyboard**
- **reading the key with a laser reader and reproducing it**
- **linking to a PC and Silca software**



Fig. 3

1.1 MAIN CHARACTERISTICS

- **Movements**

Movement of the two axes (X-Y) operates on ball screws activated by step motors, on rectified roller guides.

- **Clamp**

Standard four-sided clamp, specially designed to grip most flat keys.

- **Working tool**

Consists of a cutter in hard metal carbide, that is easily replaced. Suitable to the type of work and speed rotation needed.

- **Display**

Placed on the front of the machine.

Its technical features and positioning make it highly practical in use.

- **Laser reader**

Designed to read cuts on keys to be reproduced.

1.2 SAFETY

- **Protective shield**

The transparent protective shield is designed to cover the working parts as completely as possible, ensuring operator safety.

The shield (U) (fig. 5, page 6) must be raised in order to fit keys for cutting or carry out other operations. Raising of the shield is controlled by a microswitch and deactivates the operating and movement functions, including the cutter. A special message appears on the display to warn that the shield is not closed.

To re-start the work cycle, place the shield in its original position and press START on the machine's keyboard.

- **Emergency stops**

The red emergency button (N) (fig. 5, page 6) placed on the right-hand side of the machine is used to stop it immediately in the event of faulty operation or danger for the operator.

When the cause of the emergency has been eliminated, turn the button 45° clockwise to deactivate it.

Note: *the operator is responsible for keeping the area around the button clear so that it can be reached as quickly as possible.*

- **Laser warning**

Regulations require that warning labels in the language to be used be attached to the laser reader, as shown in fig. 4.

The adhesives are in the accessories kit provided (chap.1.5, page 8).

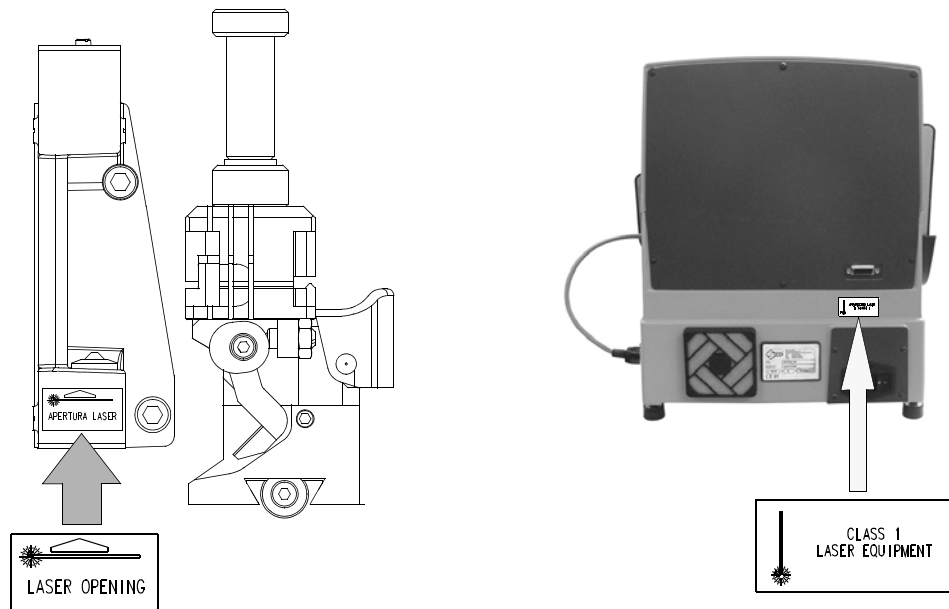


Fig. 4 - laser warning

- **Cutter motor protection**

The cutter motor is protected against overheating by a cut-out switch (located inside the motor) that will automatically stop the motor if it reaches a certain temperature. Should the switch activate:

- 1) turn the machine off and disconnect the power supply cable.
- 2) contact Silca's Technical Assistance Dept.

1.3 MAIN WORKING PARTS

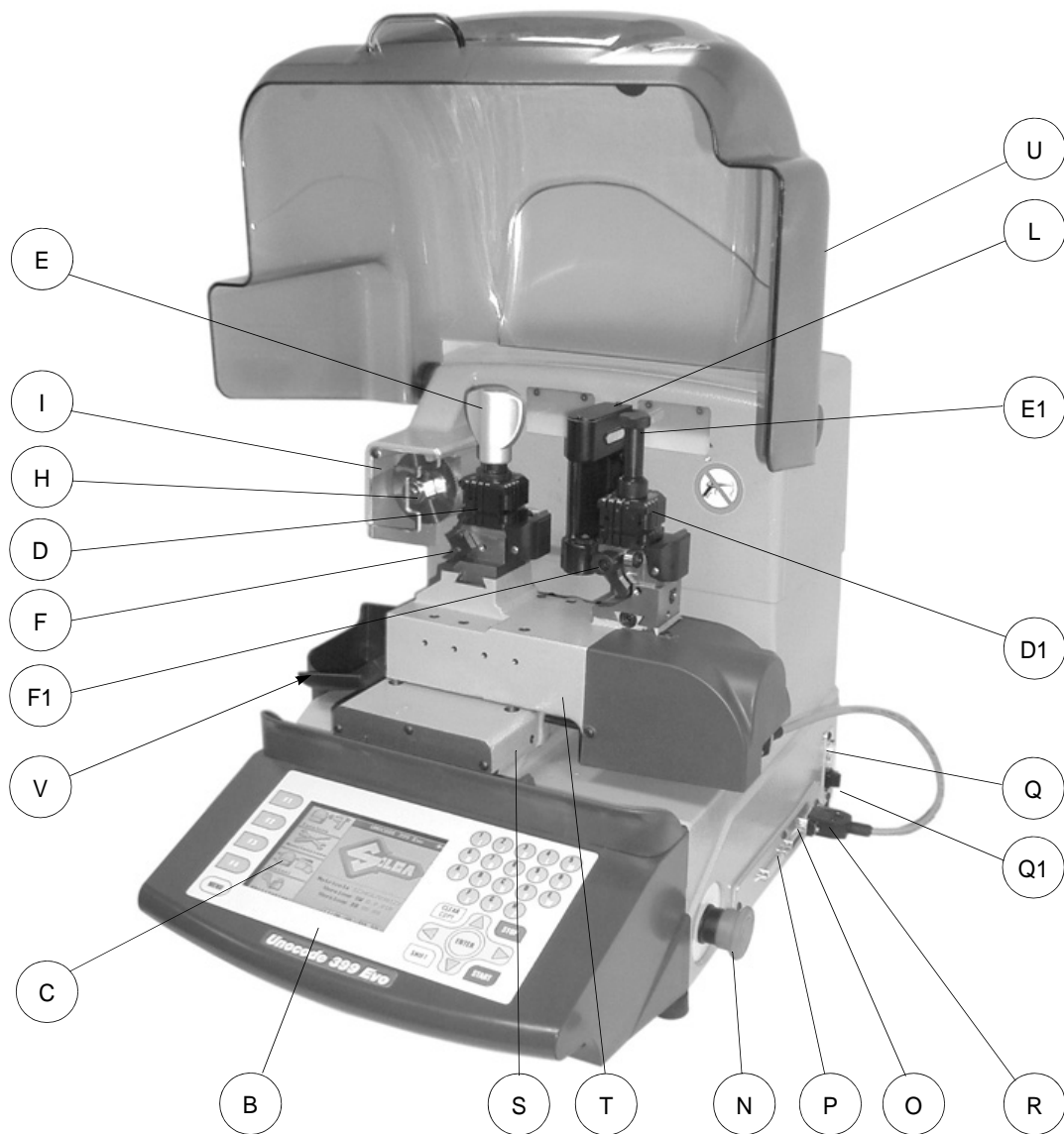


Fig. 5

- A - master switch
- B - keyboard
- C - display
- D - clamp - cutter side
- D1- clamp - optical reader
- E - clamp knob
- E1 - optical reader clamp knob
- F - key gauge - cutter side
- F1 - key gauge - optical reader side
- H - cutter
- I - cutter shield
- L - optical reader
- N - emergency button
- O - 3rd axis
- P - IN/OUT port
- Q - serial port
- Q1- USB port
- R - Y axis connector
- S - X axis carriage
- T - Y axis carriage
- U - protective shield
- U2- vacuum systems connector
- V - swarf tray



1.4 TECHNICAL DATA

Electricity supply:

230V-50Hz

100V-50/60Hz

Nominal power:

230V: 1,1 Amp. 210 Watt

100V: 3,5 Amp. 310 Watt

cutter motor:

single phase and speed

cutter:

hard metal

Tool speed:

50Hz: 2370 rpm (+/- 10%)

60Hz: 2800 rpm

Movements:

on 2 axes with ball screws activated by step motors, on rectified roller guides.
Possibility to add a 3rd axis to activate the optional tilting and rotating clamps.

Clamp:

universal 4 sided clamp to grip flat, car and cruciform keys

Runs:

X axis: 57 mm Y axis:: 32 mm

Dimensions:

width: 450 mm depth: 600 mm height: 440 mm (with raised shield 680 mm)

Mass:

Kg. 38


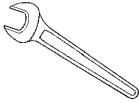
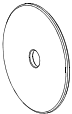

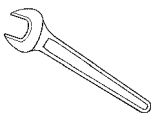

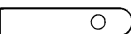

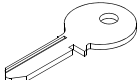


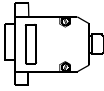


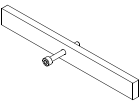





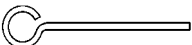

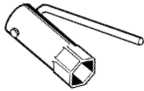



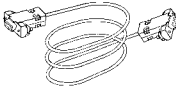

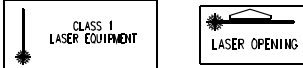

Noise level:

sound pressure Lp(A) = 80 dB(A) (cutting iron keys)

77 dB(A) (cutting brass keys)

1.5 ACCESSORIES PROVIDED

UNOCODE 399 EVO comes with a set of accessories for its operation and maintenance (tools, hex wrenches, fuses) supplied in a special tool kit comprising:

tool kit 	10 mm spanner 	D916657ZR Z1 template (regulating disk) 
D931090ZR tip stop bar with notch 	13 mm spanner 	Z20 setting template 
tip stop bar 	D912423ZR 2 Amp fuse - delayed 	D916658ZR Z3 template (regulating key) 
D900754ZR cutter release rod 	D901185ZR (230V-50Hz) 4 Amp fuse - rapid 	Z4 serial test connector 
D931082ZR 2 mm allen key 	D916568ZR 10 Amp fuse - delayed 	belt tension plate 
2,5 mm allen key 	D908726ZR 4 Amp fuse - delayed 	D908699ZR Anti-tilting device 
3 mm allen key 	D910652ZR 6,3 Amp fuse - delayed 	D933777ZR ø 1,7 mm steel pin 
4 mm allen key 	D906963ZR 19 mm socket wrench 	ø 1,2 mm steel pin 
5 mm allen key 	D906935ZR slanted brush 	D909281ZR serial cable 9/9 
6 mm allen key 	laser warning labels 	D929095ZR USB cable 

2 TRANSPORT

The key-cutting machine is easily transported and is not dangerous to handle. The packed machine should be carried by at least two people.

2.1 PACKING

The packing for UNOCODE 399 EVO is designed to ensure safe transportation and to protect the machine and all its parts.

It comprises a pallet base (b) to which the machine is attached, and a cardboard box as a cover (a).

The machine is fixed to the base of the pallet with screwed down brackets that hold it firm into place. This prevents the machine and its protective shield from any damage.

The closed packing is held in place by two straps which hold the cardboard box firmly on the pallet.

Symbols are printed on the outside of the cardboard box to give instructions and warnings for transportation.

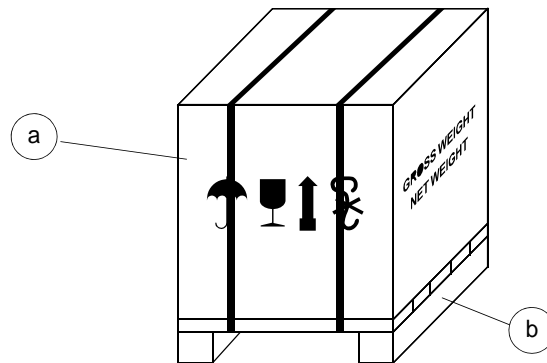


Fig. 6



Keep dry



Handle with care



This side up



Use no hooks

To prevent any damage to the machine it is advisable to save and use the brackets provided for future transportation.

2.2 UNPACKING

To remove the machine from the packing box:

- 1) cut the straps with scissors and remove
- 2) raise the top part of the cardboard box
- 3) loosen the screws, both on the front and back brackets that hold the machine to the pallet
- 4) use the special spanner (provided in the tool kit), to loosen the nuts on the machine's feet
- 5) remove the metal brackets and re-tighten the nuts on the feet.
- 6) check the contents in the box, that should comprise with the following:
 - 1 UNOCODE 399 EVO key-cutting machine
 - 1 set of documents, including: an operating manual, a spare parts list and a guarantee
 - 1 power supply cable
 - 1 tool kit

Note: *we strongly recommend you keep the packing intact for future transportation*

2.3 MACHINE HANDLING

When the UNOCODE 399 EVO has been unpacked, place it directly on its workbench; this operation should be carried out by at least two people.

Take care to lift the machine firmly holding the base, and no other part.

ATTENTION: never lift the machine by holding the keyboard stand (fig. 7).



INCORRECT!



CORRECT!

Fig. 7

3 MACHINE INSTALLATION AND PREPARATION

The key-cutting machine can be installed by the purchaser and does not require any special skills. It is supplied ready for use and does not need any special set up. However, the operator may have to control a few things before operating the machine.

3.1 CHECKING FOR DAMAGE

UNOCODE 399 EVO is solid and compact and will not normally damage if transport, unpacking and installation have all been carried out according to the instructions in this manual. However, it is always advisable to check that the machine has not suffered any damage.

3.2 ENVIRONMENTAL CONDITIONS

To ensure that the best use is made of the key-cutting machine, it is important to place it in a well-aired area which is not too damp.

The ideal conditions for the machine are:

temperature between 10°C and 40°C; relative humidity: approx 60%

3.3 POSITIONING AND INSTALLATION

- 1) Place the machine on a horizontal surface, solid enough to support the weight of 38 Kg.
 - to work with ease, we suggest that the workbench be approximately the height of the operator's hip.
 - it is important to leave clearance of at least 30 cm behind the machine and on each side to ensure proper ventilation.
- 2) Ensure that the machines voltage is the same as that of the mains power supply, which must be properly earthed and provided with a differential switch.
- 3) Connect the power supply cable to the power supply socket.

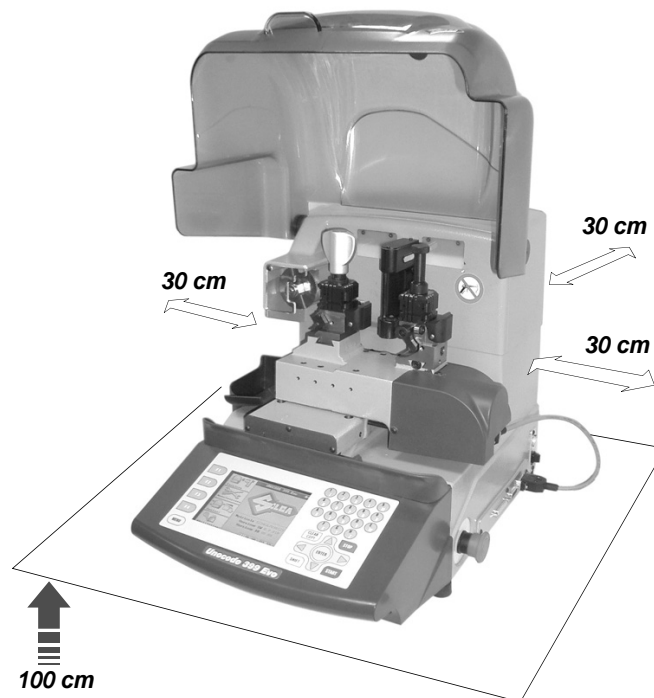


Fig. 8

3.4 DESCRIPTION OF WORK STATION

The machine needs only one operator, who has the following controls at his/her disposal (fig. 5, page 6):

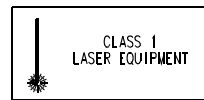
- master switch placed on the back of the machine
- key-positioning clamp
- keyboard
- display
- emergency button

3.5 GRAPHICS

- There is a prohibition warning label on the front side of the reader (fig. 9). This label must never be removed.
- Two laser warning labels must be attached to the optical reader (chap.1.2, page 5).



Do not use compressed air
for cleaning



laser warning labels

Fig. 9

4 "SET UP" AND USE OF THE MACHINE

4.1 USE OF THE CLAMP

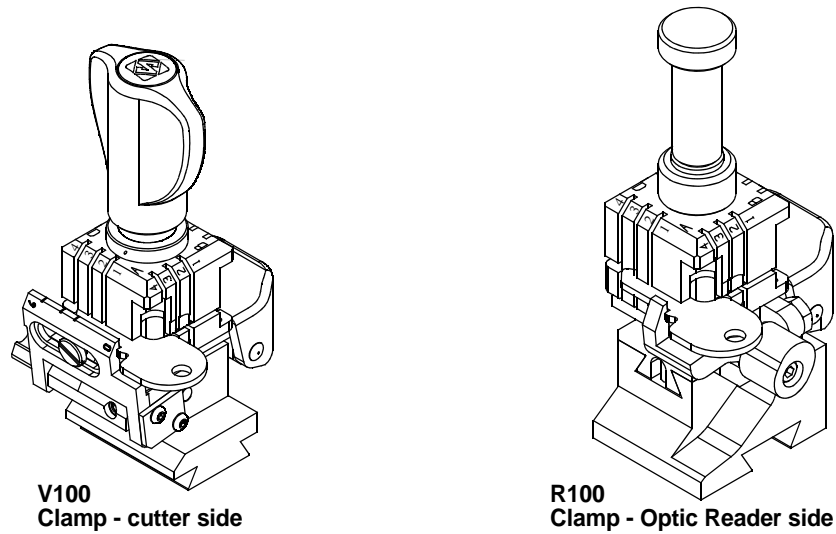


Fig. 10

The four-sided clamp ensures excellent grip on the keys placed on their back or profile sides (fig. 11).

- Keys with 1 or 2 cuts to reproduce by code should be fitted mainly on the A and/or B side of the clamp.
- When copying with the optical reader the key can be fitted to any side (A, B, C or D) of the clamp.

- For keys to be cut by code the side of the clamp on which to place the key is shown on the machines display.
- For keys to be copied with the optical reader the side of the clamp to be used is at the discretion of the operator.
- To fit keys with tip stops on the optic reader clamp, fit the bar provided into the special grooves (fig. 12).

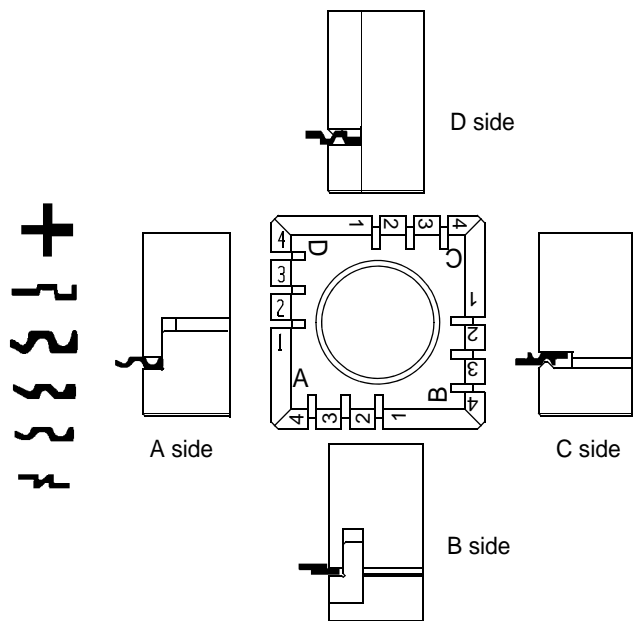


Fig. 11

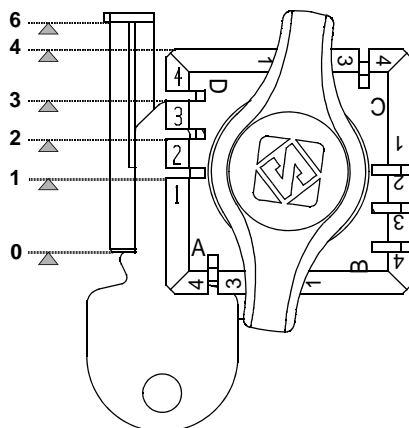


Fig. 12 - key stops

ATTENTION: the knobs are gauged so that they do not exert too much pressure for closing (if pressure is too high they only idle), which would damage the key and the parts of the clamp (including the knob).

To turn the clamps:

With loosened handle (E) a light rotation of the clamp is sufficient (gripping by the 2 jaws) to turn it to the required side. Alignment is automatic and guaranteed by the mobile pressure device (D5) (fig. 13).

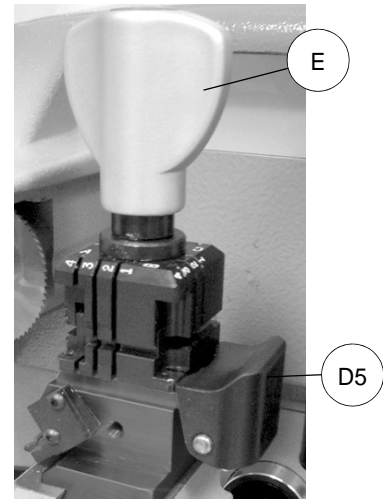


Fig. 13

Note: before starting to cut a key the V100 clamp gauge goes automatically to the idle position so there is no need to lower it, but the R100 clamp gauge must be lowered manually.

USING THE PINS

Copying with the optical reader

For keys with narrow stems the pins must be placed between the bottom of the clamp and the back of the key so that the key protrudes sufficiently out of the clamp and therefore can be properly read and cut. If the key has a narrow stem and is also very thin, 2 pins must be used (fig. 14).

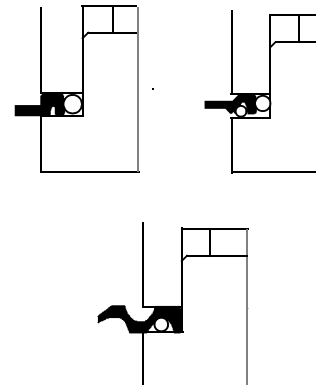


Fig. 14

If the original key is broken, place a suitable sized pin in the groove of the keys stem so that it is properly held in place and therefore can be copied (fig. 15).

Note: the diameter of the pin used for the original key must be the same as that of the pin used for the blank key; only in this way will the two keys be locked in the same position.

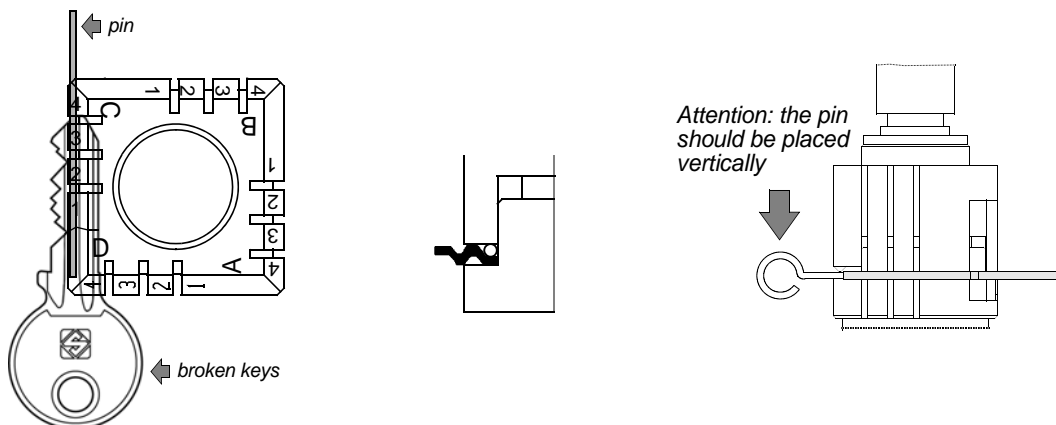


Fig. 15

4.2 CUTTING BY ELECTRIC CONTACT

The UNOCODE 399 EVO key-cutting machine is equipped with a low voltage electrical contact device which permits the cutter to individualize the key blank as it approaches the cutter during the cutting phase (fig. 16).

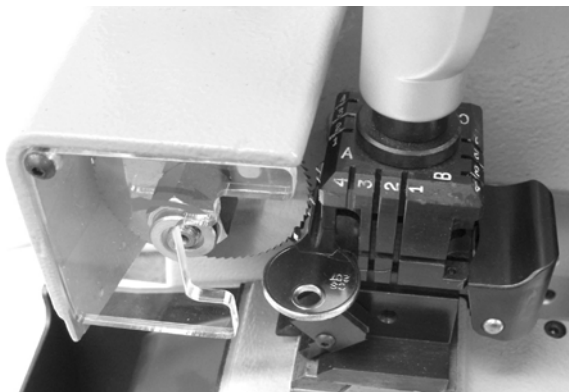
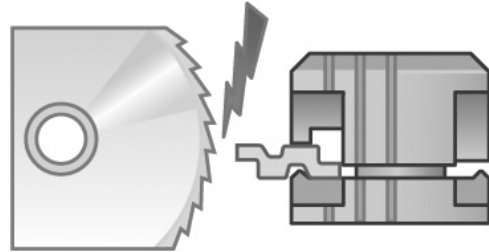


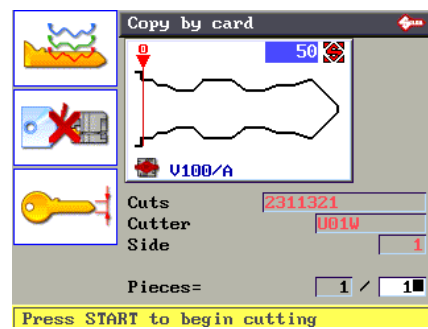
Fig. 16



This technical solution permits the operator to secure the key to the more appropriate side of the 4 faced clamp (A, B, C or D) therefore improving the grip on the key and eliminating the need of pins and/or adaptors.

With the electrical contact card enabled, depth calibration is automatically calculated when the cutter touches the keys during the cutting process.

Electrical contact is guaranteed for keys in steel, brass, silver nickel, Zamak or iron (with or without nickel-plating).



- Press F2 to enable or disable the electrical contact function to read the key blank measurements.

The symbol * in the clamp field means that the key will be cut reading the key blank measurements by electrical contact.

A red "X" on the electrical contact icon means that it has been disabled.



Note: some cutting cards do not include electrical contact. In such cases the software does not allow editing.

4.2.1 IMPROPER USE OF ELECTRIC CONTACT

It is not permitted to cut ultralite anodized aluminium keys, plastic keys or any keys with materials that do not have electrical conductivity by means of electric contact.

ATTENTION: for these types of materials, insert standard cutting.

Cuts cannot be repeated on the same side of the key when electric contact cutting is used.

All data cards provided by Silca are in the machine's memory. The cards are enabled or disabled for code cutting by electric contact at Silca's discretion.

4.3 FITTING THE CLAMP TO THE MACHINE

To remove the clamp unit:

- loosen the grub screw (D2) (fig. 17) and slide the clamp out of the dovetail guide.

To install the clamp unit on the machine:

- slide the clamp into the dovetail guide, pushing it all the way in, then secure it by tightening the grub screw (D2).

These instructions refer exclusively to the standard clamp (V100). For the use of optional clamps please refer to the instructions provided along with them.

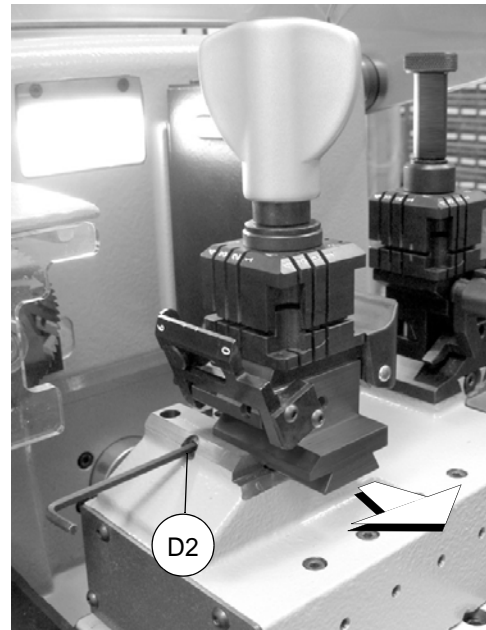


Fig. 17

4.4 CUTTER

The majority of keys utilize the standard cutter for code cutting. Only in certain cases some special keys with particular type cuts require different cutters. To change the cutter see chapter 4.5.

4.5 CHANGING THE CUTTER

- 1) raise the protective shield.
- 2) remove the cutter protective shield (i) by loosening the screw (i2).
- 3) slide the cutter release rod (X) into the hole located on the left side of the machines cutter shaft chassis (fig. 18).
- 4) loosen the cutter locking nut (turning it clockwise) with the 19 mm socket wrench (X1) provided with the machine.

ATTENTION: the thread is left-handed.

- 5) replace the cutter, then tighten the nut (turning it counter-clockwise) and remove the rod from its hole.
- 6) place the cutters protective shield (i) back into position securing it with the screw (i2).

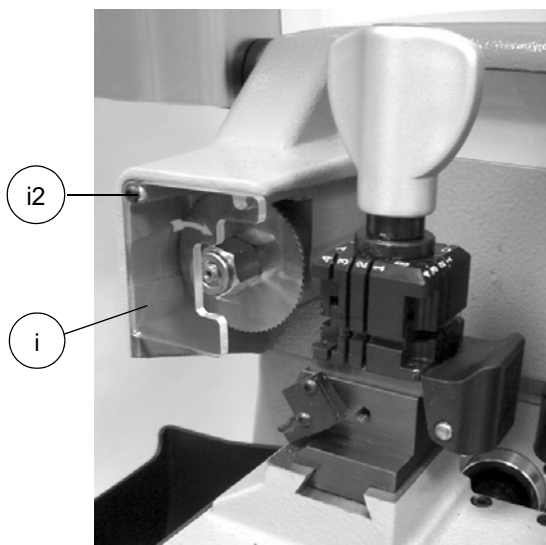
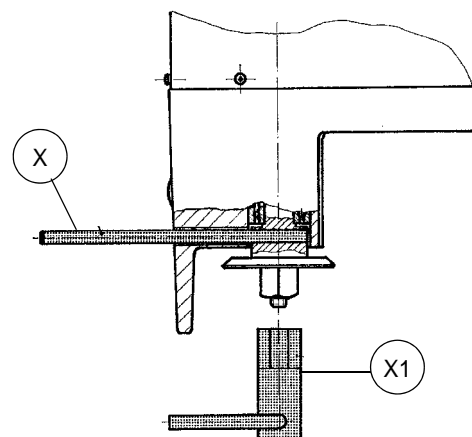


Fig. 18



ATTENTION: when replacing a worn cutter with a new one or with a re-sharpened cutter consult chap.5.8 "GAUGING", page 42.

5 OPERATING GUIDE

Introduction

The Operating Guide below explains how to use the UNOCODE 399 EVO without a Personal Computer.

All operations to manually use the key-cutting machine are explained step by step.

The programs available for Personal Computers connected to the key-cutting machine are able to transmit data for cutting, reading or decoding keys.

Programs for Personal Computer eliminate manual procedures of certain functions, once the data has been transmitted to the machine it bypasses some of the operating guides screens.

When the UNOCODE 399 EVO is used with a Personal Computer, the operating guide does not change its displays logic, with the exception of all the screens that are rendered unnecessary.

5.1 INITIAL OPERATIONS

When the key-cutting machine has been placed on its workbench and connected to the mains (chap.3.3, page 11), proceed as follows:

- 1) make sure that the emergency button is not turned on.
- 2) turn the machine on by means of the main switch that is located on the back of the machine.
- 3) to check or alter the parameters for use of the machine, consult the "OPTIONS" menu (chap.5.10, page 56).

When the machine is turned on the display shows the following screen:



Fig. 19

Besides the first 4 icons relating to the main functions, listed on the left, the following information appears:

- **Name of the key-cutting machine**
- **Serial number of the key-cutting machine**
- **SW version: machine program version**
- **DB version: version of the cutting card Database on board the machine**
- **Date**
- **Time**
- **Flashing word MENU (press MENU to view the other main functions)**

5.2 MACHINE KEYBOARD AND FUNCTION BUTTONS

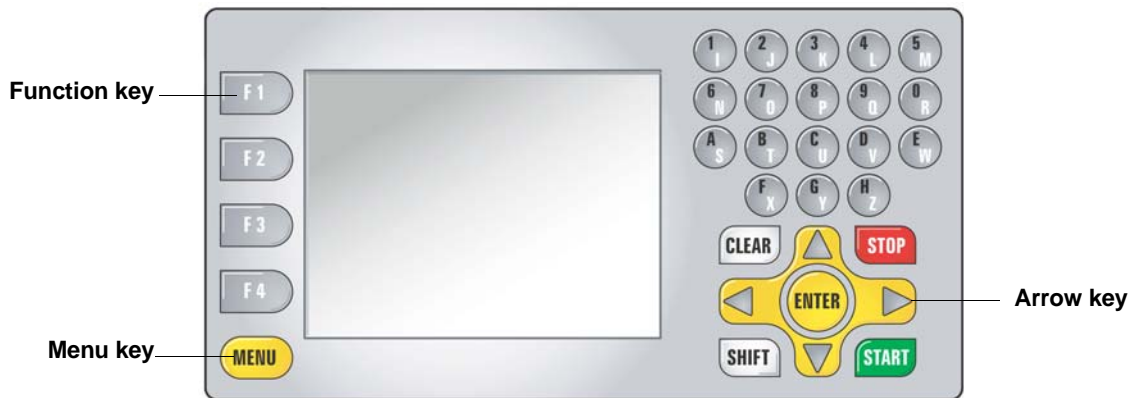
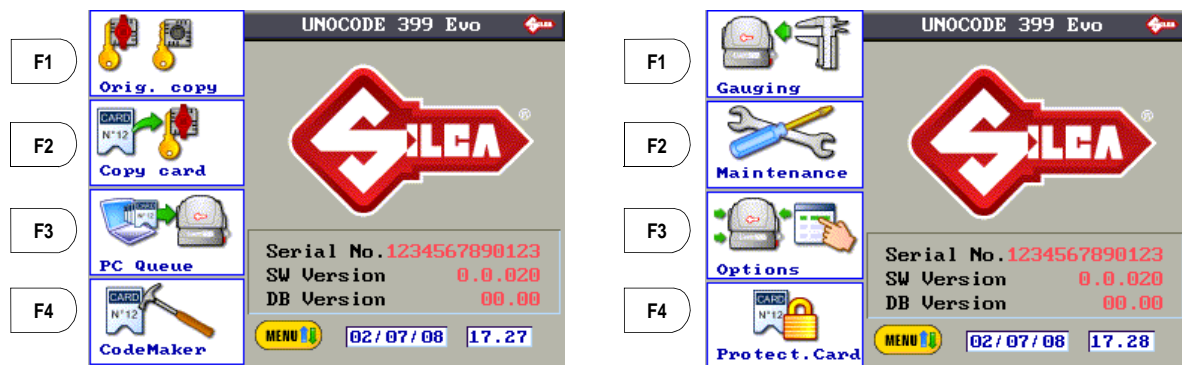


Fig. 20

- The MENU key is used to view the list of main functions. The MENU key is always active from any of the windows.
- F1 - F2 - F3 - F4 function keys are used only for accessing one of the functions (icons) listed on the side.
- Arrow keys (right/left/up/down) are used to move the cursor (navigation) in the various fields on the screen that require the entry of values/parameters.
- The CLEAR key is used to delete a single character.
- Press the SHIFT+CLEAR keys together to delete a whole line.

Main menu functions

- Copy from Original
- Copy card
- PC queue
- CodeMaker
- Gauging
- Maintenance
- Options
- Enabling

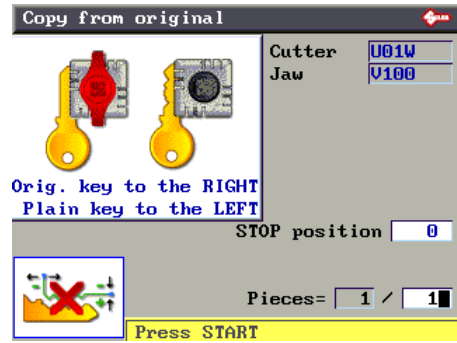


Press the MENU key repeatedly to view the list of icons relating to the main functions of the machine program.

5.3 COPY FROM ORIGINAL

In the initial screen press F1 to use the function. This function is used to make a direct copy from the key, without further stages. The "Copy from Original" window shows certain data and icons:

- **Cutter to use (cannot be edited)**
- **Clamp to use (cannot be edited)**
- **Stop position (settings go from 0 to 6; other values can be written but will not be confirmed)**
- **Pieces = 1 / 1 (up to 999 pcs. can be set)**



Minimum distance:

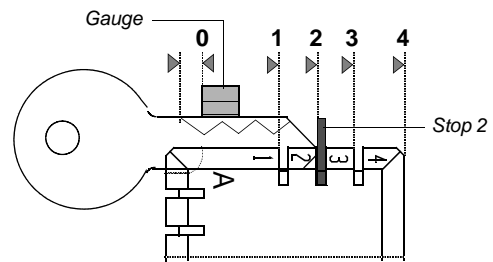
The number shown on the machine's display represents the X axis distance between the key blank shoulder and the beginning of the first cut. This function is extremely important with keys that require cuts on both sides as it ensures precise positioning on the key 2nd side.

The set figure is 50 hundredths of a mm, which can be varied:

- min.0 - max. 99 hundredths of a mm.

ATTENTION: settings that are too high may render precise cuts impossible, with the following message on the display:

MIN. Parameter of DISTANCE FROM STOP is incompatible with selected card!



Note: the icon in the lower left corner of the menu can be activated by the F4 key (see chap.5.4 "Copy with adjustments", page 20).



Set the number of pieces to be cut, the type of Stop to use (up/down arrow keys to move and numerical keys for entry). As illustrated in the figure, with Stop 0 and pieces 1, fit the key blank into the clamp on the cutter side and the original key into the clamp on the reader side. Lower the right-hand clamp gauge and press START to begin.

Note: after placing the original key in the r/h clamp, remember to lower the gauge. If this is not done, when reading starts the machine will stop and show the following message on the display:

In this case lower the gauge and press START to continue.



First the display will show:



and then:

- Press STOP to confirm the end of the operation.
- Press ENTER if you wish to cut other keys.

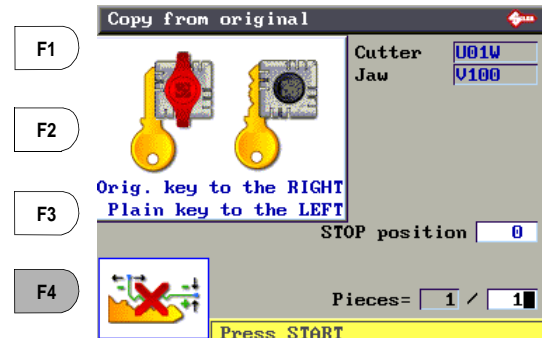


5.4 COPY WITH ADJUSTMENTS

In this mode an original key is copied in 3 stages:

- Reading
- Setting up of adjustments
- Cutting

The icon in the lower left corner of the menu can be activated by the F4 key. Press F4 again to return to the "Copy from Original" menu.

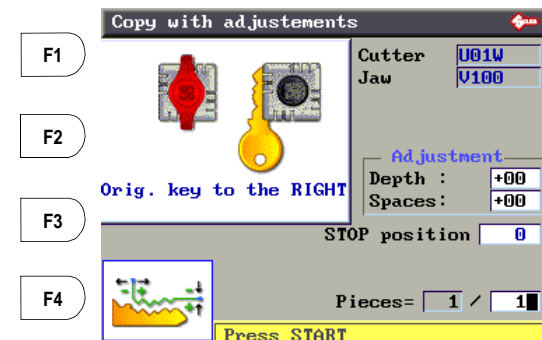


When you click on F4 the screen changes:

- The icon/figure of the original key placed in the right/hand clamp (reader side) and an empty left-hand clamp (cutter side):

A box appears containing adjustments in depth and spaces.

- Press START to start reading.

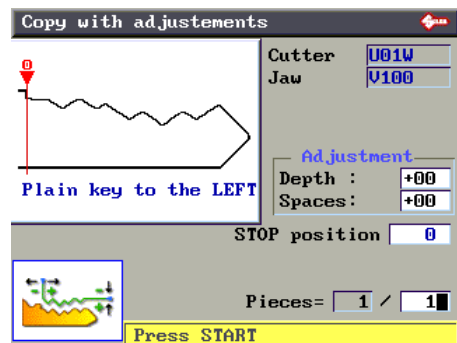


Note: after placing the original key in the r/h clamp, remember to lower the gauge. If this is not done, when reading starts the machine will stop and show the following message on the display:

In this case lower the gauge and press START to continue.



When reading is finished, to enter the adjustments, use the "up/down" arrow keys over the fields (Depths and Spaces) in which the adjustments are to be made:



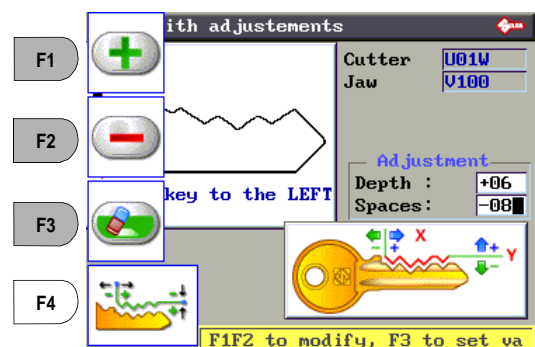
- Press F1 to get positive values (+).
- Press F2 to get negative values (-).
- Press F3 to cancel the set adjustments.

Adjustments possible for Depth (-30 to +30 hundredths of a millimetre):

- One value (positive or negative) raises or lowers all cuts.

Adjustments possible for Spaces (-30 to +30 hundredths of a millimetre):

- One value (positive or negative) moves all the cuts (from the stop) to the right or left.

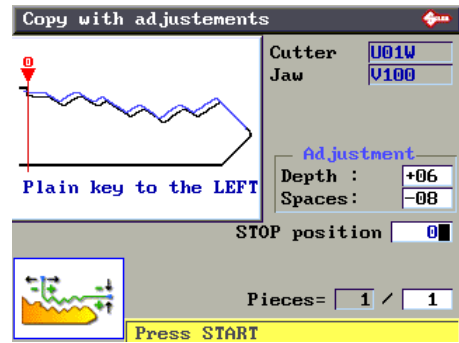


Warning! The presence of this symbol indicates that adjustments to the card have been applied!

Press ENTER to view the “new” key with the adjustments made. The display will show:

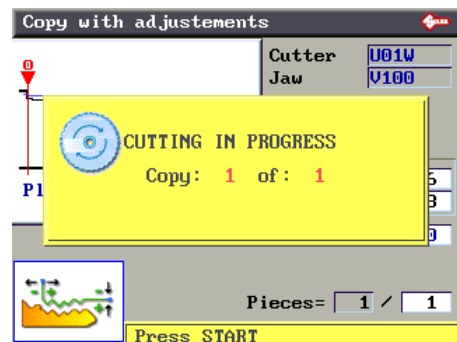
- a black outline of the original key (key read).
- a blue outline of the key to be cut, with the adjustments made.

Fit the key blank into the clamp on the cutter side and secure. Lower the safety shield and press START to proceed with cutting.



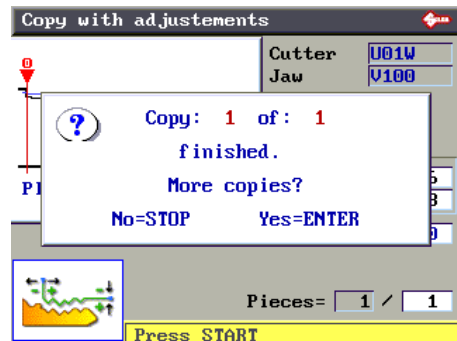
Warning! The presence of this symbol indicates that adjustments to the card have been applied!

First the display will show:



and then:

- Press STOP to confirm the end of the operation.
- Press ENTER if you wish to cut other keys.



5.5 COPY FROM CUTTING CARD

From the initial screen press F2 to use the function.

One part of the machine's internal memory is used as a cutting card archive.

A cutting card is a database of "Spaces", "Depths" and cutting angles for all the keys Silca considers can be taken into consideration.

SILCA and USER cutting cards can be selected by pressing F1.

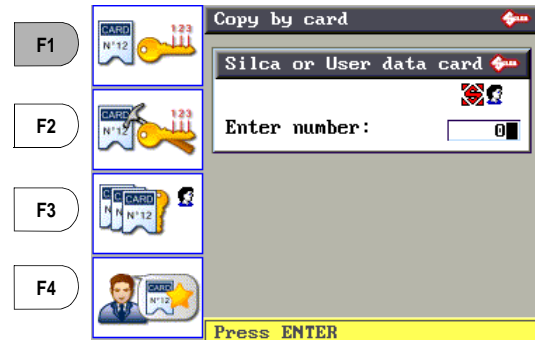
• SILCA cutting cards

SILCA cards are found in:

- Paper catalogues
- Electronic catalogue
- Silca Key Programs

Certain parameters on SILCA cards can be edited, but the adjustments **CANNOT BE SAVED** in the machine memory.

The number of SILCA cards is periodically increased with the "Silca Code Program" update, which can be purchased separately. Through the Silca Code Program the user can update the program and data on the machine.

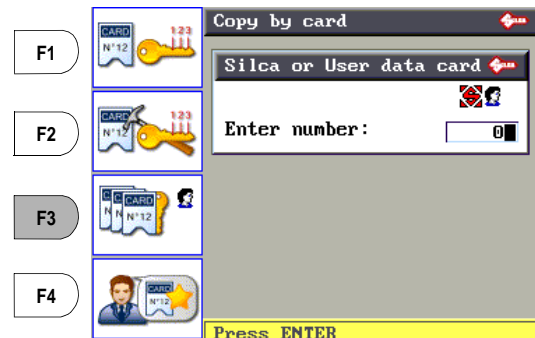


• USER cutting cards

Cards customized using Silca Key Programs on the PC and sent to the machine. They can be:

- Created with Code Maker of SKP
- Silca SKP cards with certain parameters edited.

Certain parameters on USER cards can be edited and editing **CAN BE SAVED** in the machine memory.



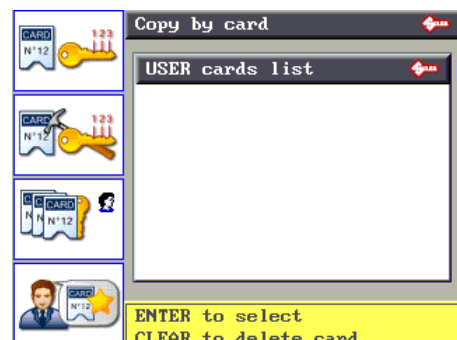
- Press F3 to view the list of User cutting cards.

Operational keys:

Up/Down arrows: to scroll cards

ENTER: to select

CLEAR: to delete selected card



• **CODEMAKER cutting cards:**

Customized cards created using CODE MAKER on the machine.



- Press F3 to view a list of CodeMaker cards.



EXAMPLE: Copy from SILCA cutting Card

- 1) Digit the card number (e.g.: 50):



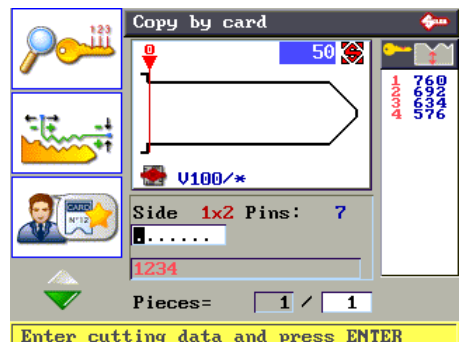
Press ENTER, the display shows:

.....

The dots shown represent possible cuts. The same card can be used for a number of keys with a different number of cuts.

If a key is used with fewer cuts than the dots on the display, just digit a partial combination.

- 2) Digit the cuts.
 - Single side Side 1
 - Double symmetric Side 1x2
 - Double asymmetric Side 1 / Side 2



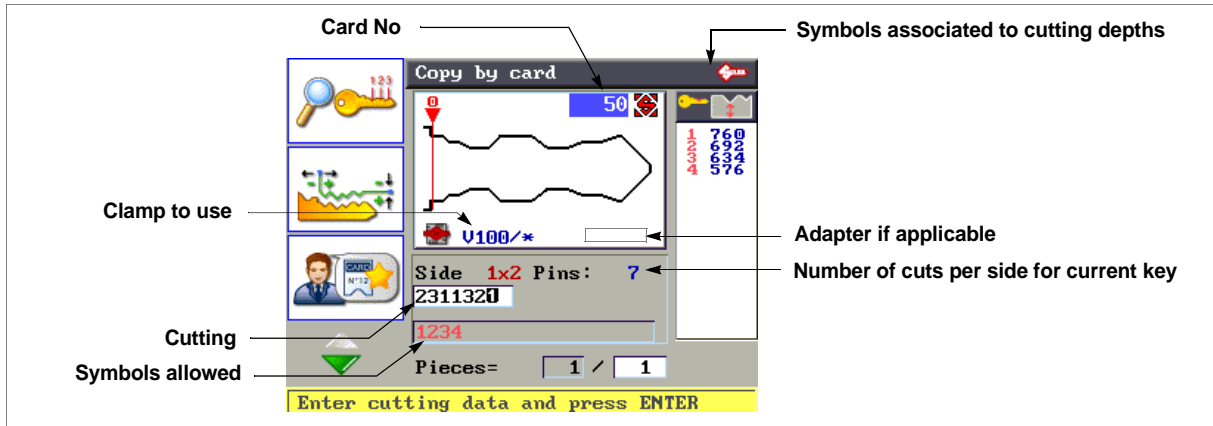
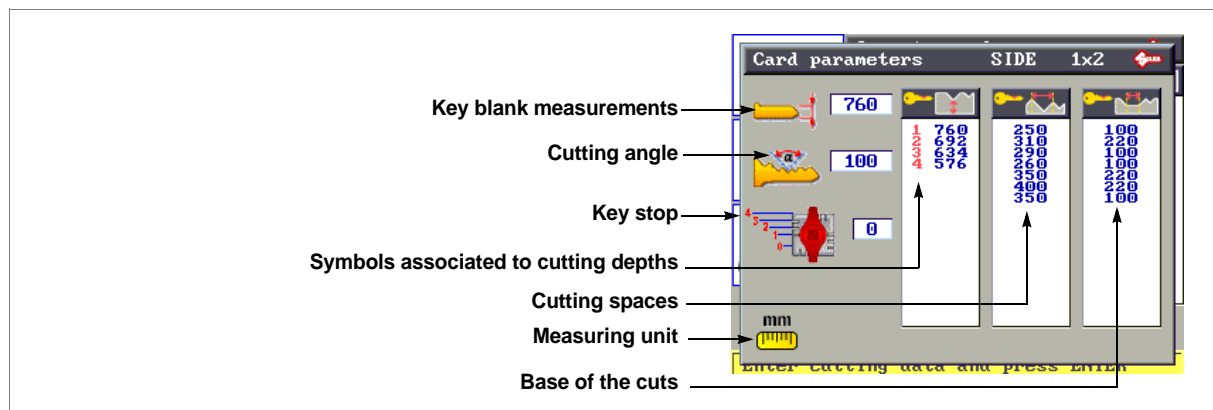
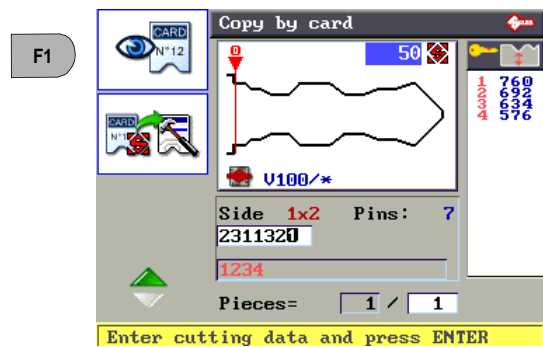


Fig. 21

- Press F1 to consult the cutting parameters on the card.



Press STOP to exit.

- Press F2 to set up manual adjustment of cutting depths and spaces.



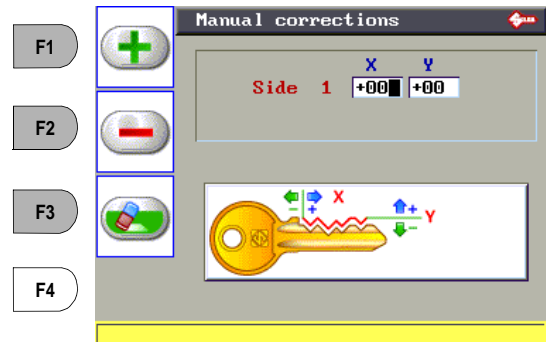
- Press F1 to set positive values (+).
- Press F2 to set negative values (-).
- Press F3 to cancel the adjustments made.

Adjustments possible for depth (-30 to +30 hundredths of a mm):

- one value (positive or negative) raises or lowers all cuts.

Adjustments possible for spaces (-30 to +30 hundredths of a mm):

- one value (positive or negative) moves all cuts (from the stop) to the left or right.

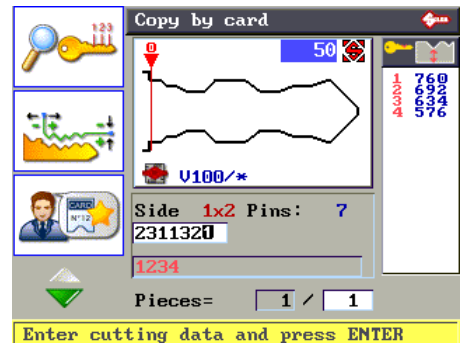


Press STOP to exit.



Warning! The presence of this symbol indicates that adjustments to the card have been applied!

3) Press ENTER to continue.



Clamp: V100/*

The special symbol (asterisk) means that the cuts will be made by electric contact therefore it is unnecessary to select the clamp side.

Pos.: 0

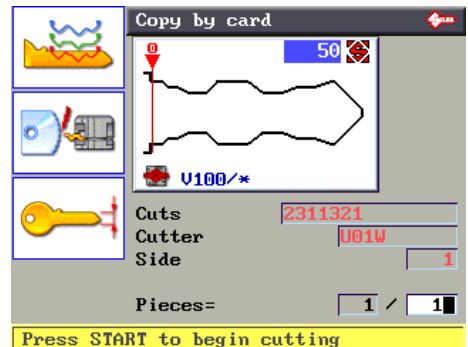
Place the key to be cut into the V100 clamp (cutter side) using the stop that is shown.

Cutter: U01W

cutter to use.

Pieces:

enter the quantity of keys to be cut (max.999).



• **Decoding by data card**

Press F1 to decode the selected data card.

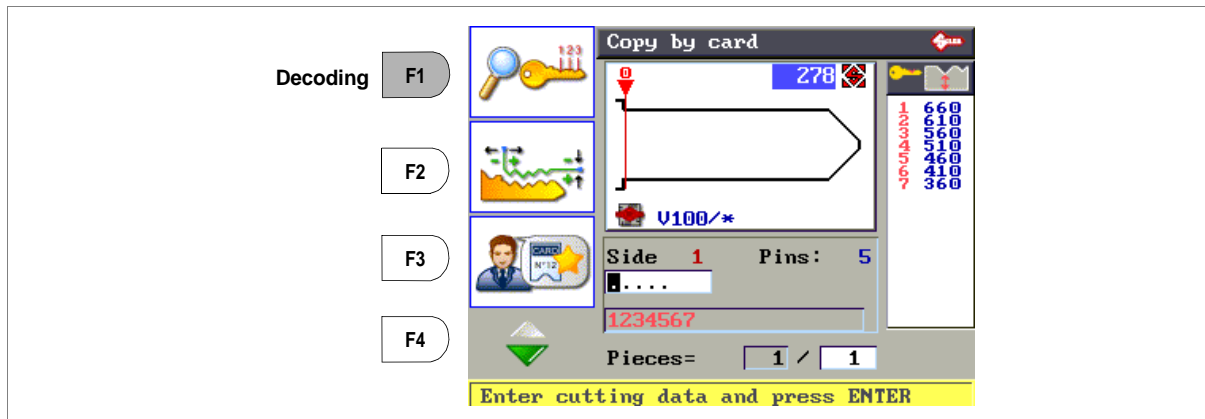
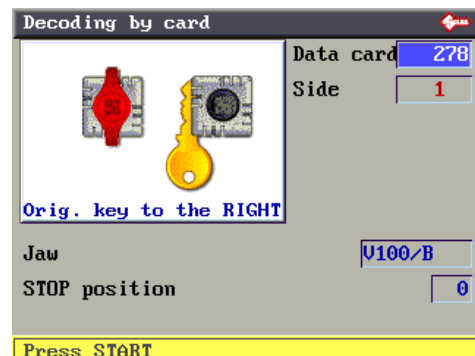


Figura 22

- Press ENTER to continue.

1) Press START to begin the DECODING operation.

Note: *the decoding operation is not available for all data cards.*



At the end of the reading operation the display shows:

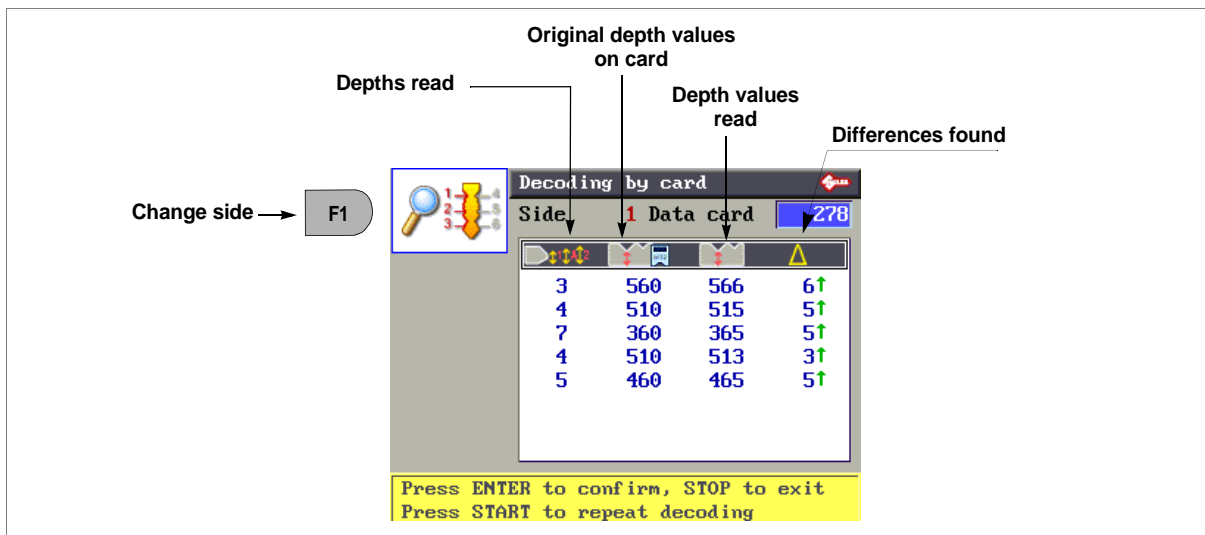


Figura 23

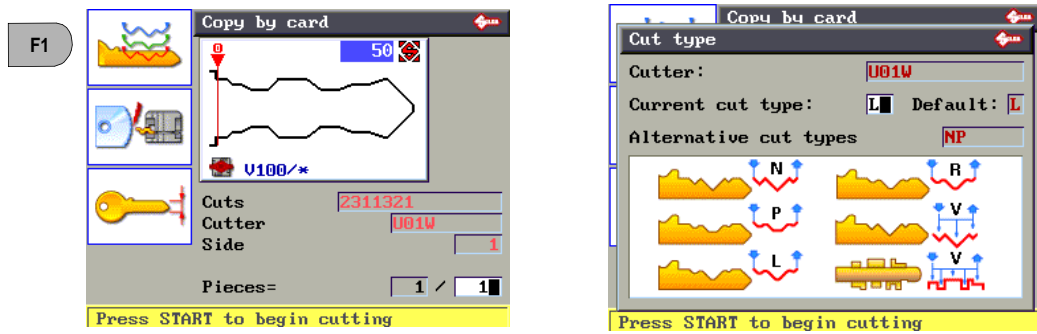
- Press ENTER, the key will be cut with the original measurement of the card.

F1: *In the event of decoding keys with asymmetrical cuts, press F1 to view the values for the 2nd side.*

↑ ↑ Decoding value HIGHER than the original depth value:
 - GREEN arrow = ACCEPTABLE VALUE
 - RED arrow = UNACCEPTABLE VALUE

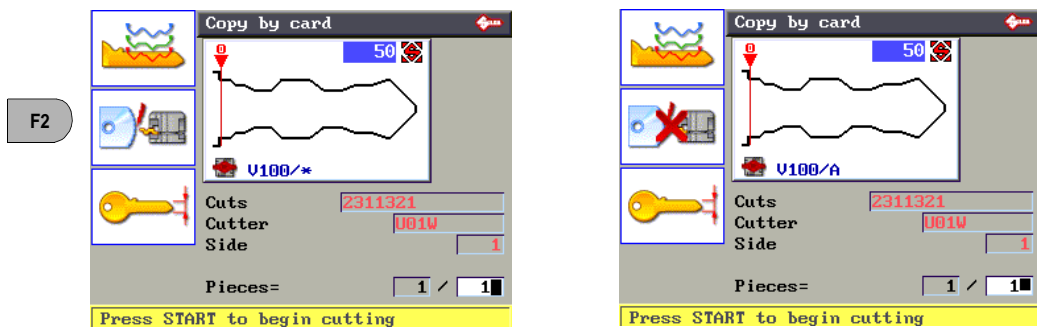
↓ ↓ Decoding value LOWER than the original depth value:
 - GREEN arrow = ACCEPTABLE VALUE
 - RED arrow = UNACCEPTABLE VALUE

Modify cutting method



- By pressing F1 it is possible to view the cutting method set by Silca for the card and to modify it when possible (chap.5.5.1, page 32).

Use of Electric Contact



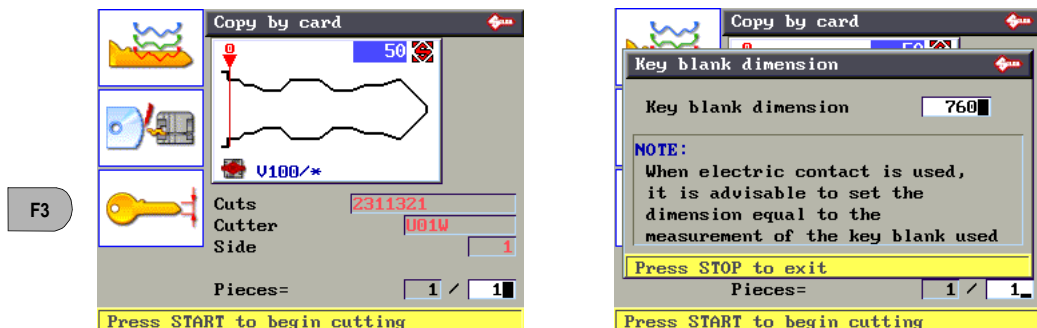
- Press F2 to enable or disable the electrical contact function to read the key blank measurements.

The symbol * in the clamp field means that the key will be cut reading the key blank measurements by electrical contact.

A red "X" on the electrical contact icon means that it has been disabled.



Note: some cutting cards do not include electrical contact. In such cases the software does not allow editing.



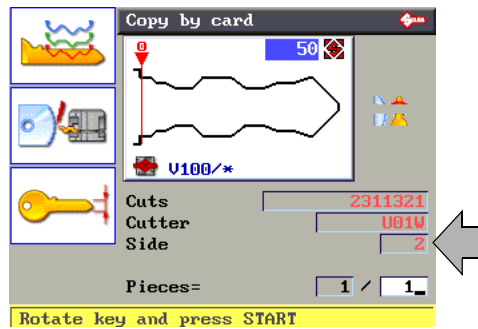
- Press F3 to vary the setting for the value of the key blank measurements.

Note: when electrical contact is used it is advisable to set key blank measurements that are the same as those of the key to be cut.

- 2) proceed with cutting the first side by pressing the START key.



- 3) Turn the key and cut the second side if the key is symmetrical, as in this case. Press START.



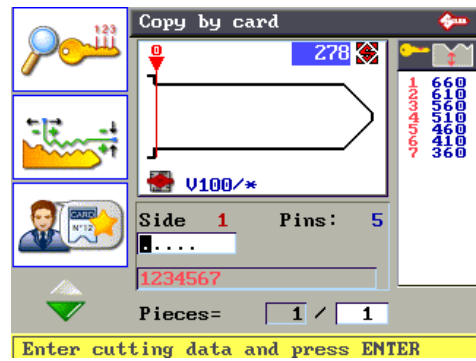
When the last side of the last key has been cut, the screen shows:



• **Saving Data Card in Favourites Menu**

Press F3 to save in the Favourites Menu:

- a SILCA data card
- a USER data card
- a CODEMAKER data card

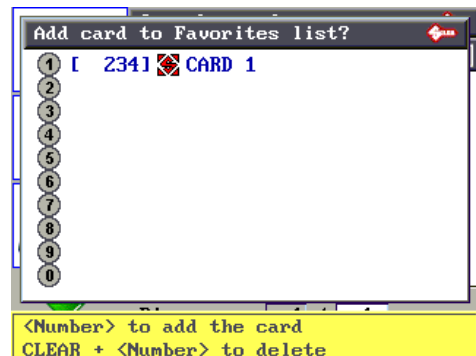


F3

- Press ENTER to continue.

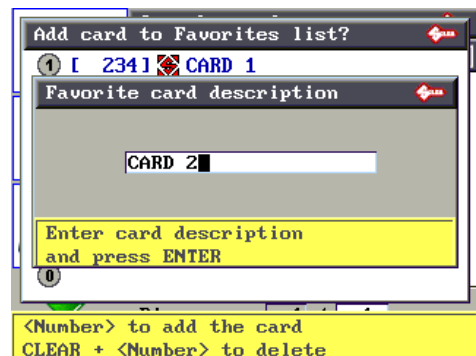
From the keyboard digit a number from 0 to 9 to assign a position to the data card to be saved.

If all the numbers are taken, re-use an existing position.



Press ENTER, the display will show:

- Press ENTER to return to the "Copy by card" menu.
- Press F3 to view the card saved into the Favourites menu.



Press F4 from the initial "Copy by card" screen to view a list of "Favourite" data cards.



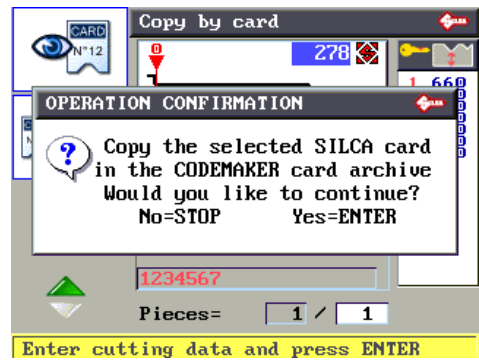
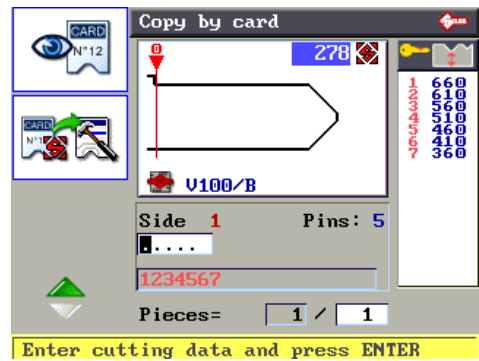
• **Copy SILCA Data Card onto CODEMAKER**

Press F2 to copy a SILCA data card on the CODEMAKER and change some of the parameters.

ATTENTION: not all SILCA data cards can be copied onto CODEMAKER. If there is no icon the data card involved cannot be copied (due to incompatible data).

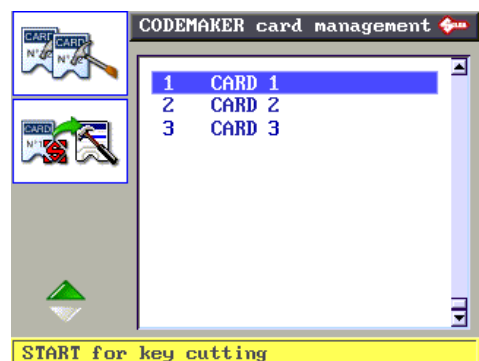
F2

Press ENTER, the display will show:



The function "Copy SILCA data card" onto CODEMAKER can be activated also by the CODEMAKER function.

F2



5.5.1 SPECIAL CASES

- **Cutting a key with two asymmetrical sides**

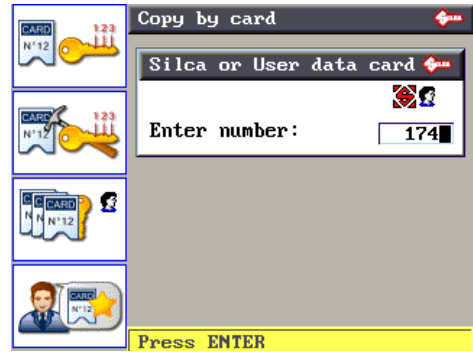
Operational keys: use the [up/down] arrow keys to be able to visualize all data.

Proceed with the cutting process.

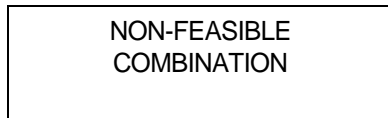
- **Cuts not allowed**

When the machine is used manually with certain data cards, it may not be possible to carry out certain entered combinations. This happens when the cutting depths are not compatible in the order the user entered the possible cuts.

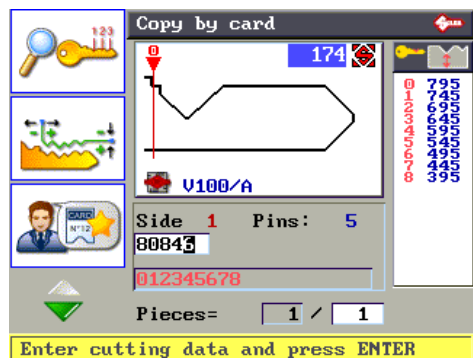
Example:



After entering the cutting combination the Silca software calculates the validity of the data. If there is inconsistency, when the ENTER key is pressed the following message appears:



This message is explained below.



The reason for the conflict between certain cuts is explained simply in the case shown.

With regard to the cut that originated the message <NON-FEASIBLE COMBINATION> it can be seen that between the two deep cuts (8) and the constant angle (100°) the intermediate cut (0) would be removed.

This happens when the cutting angle N (Normal) is not made variable by means of the type of cut L (Laser).

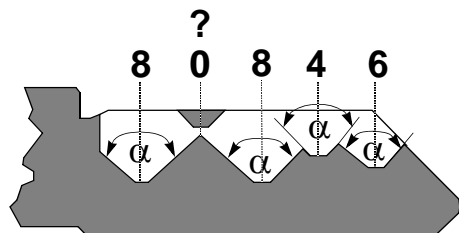


Fig. 24

The new drawing of the key shows how for the same cutting process (80846) the cutting angles are automatically calculated by the conjunction of the cutting base with a straight line.

This aspect, admissible with certain car keys, is more commonly known as 'the ideal cutting line'.

ATTENTION: in this example it can be seen that the β angle is less than 45°. This could cause serious problems with a lock, making it difficult or impossible to place the key into the cylinder or remove it.

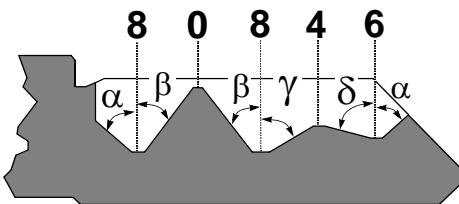


Fig. 25

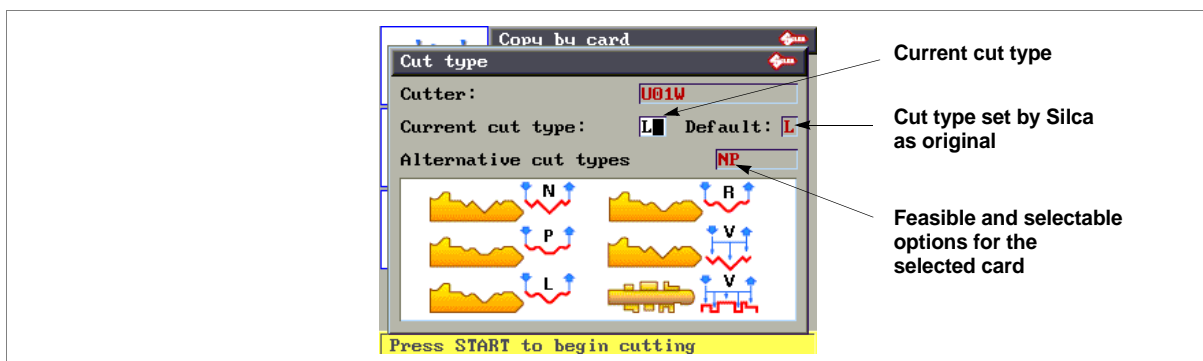
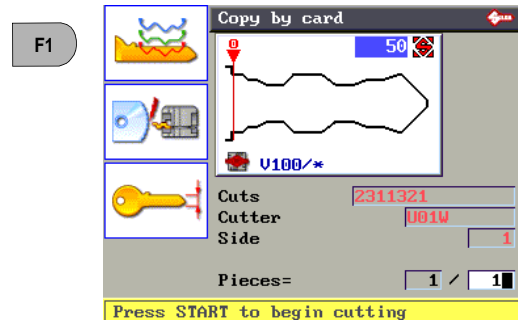
Control of the combinations in the Options menu can in any case be disabled.

• **Changing the Types of Cut**

All the data cards provided by Silca have the type of cut pre-set according to the original parameters. The types of cut possible with UNOCODE 399 EVO are: Normal, Flat, Laser and Vertical.

EXAMPLE OF HOW TO CHANGE THE TYPE OF CUT:

- Press F1 key.



All the technical data regarding the types of cuts stored in the machine's memory can be changed according to the user's requirements.

ATTENTION: for certain cutting methods the standard cutter U01W must be replaced with a specific cutter.

		<p>NORMAL For conventional car and door keys.</p>
		<p>FLAT Mainly used for car keys where the cut edges are rounded to facilitate the movement of the blades when the key is put into the lock.</p>
		<p>LASER Conjunction of the cutting angles is determined automatically by the machine, allowing cuts to be made with variable angles; this facilitates the smooth entry of the key into the lock, prolonging the working life of the key.</p>
		<p>VERTICAL Necessary for special keys with small bits (Silca art. FO19P, FO21P...) where a special cutter is required. When this cutting method is used a special angled cutter is needed.</p>

• Changing the cutter

For certain cutting methods the standard cutter U01W must be replaced with a specific cutter.

EXAMPLE WITH FO21P key:

Note: *replace the cutter according to the instructions in chap.7.3, page 69.*

• Use of Adaptors

Some of the data cards provided by Silca may show a new parameter (Adapt.:B...) which indicates the type of accessory that is needed to cut the key in question (fig. 21, page 25). See the leaflet included with the UNOCODE 399 EVO machine.

5.5.2 LIMITED ACCESS TO DATA (PROTECTED SYSTEMS)

Silca has predisposed limited access to some of the data in the Database, in compliance with agreements with some makers. Limitations apply to:

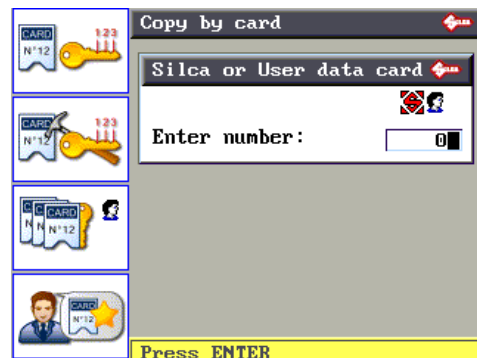
- DATA CARD: If the key-cutting card is protected, access is denied.

Gain access to protected data in the following way:

- **request the maker's authorization.**
- **communicate to Silca:**
 - The key-cutting machine **SERIAL NUMBER**
 - The **ACTIVATION CODE**
 - Key-cutting **Machine ID**

Silca will issue a Password to enter in order to enable key-cutting of the protected system.

Example: Silca provides a protected data card No 2211.



When card 2211 is selected from menu F1 the following appears on the screen:

When authorization has been received from the maker, apply to Silca for a password, providing the following information:

- **Key-cutting machine serial No 1170145634567**

Read the serial number of the ID plate located on the back of the key-cutting machine or on the initial screen on the display.

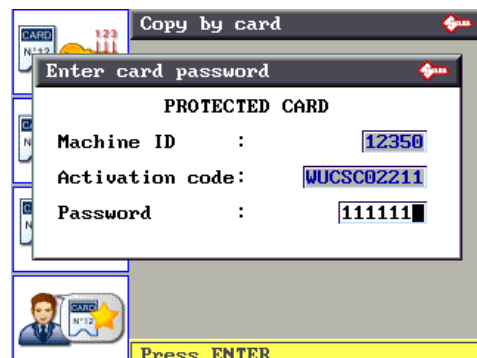
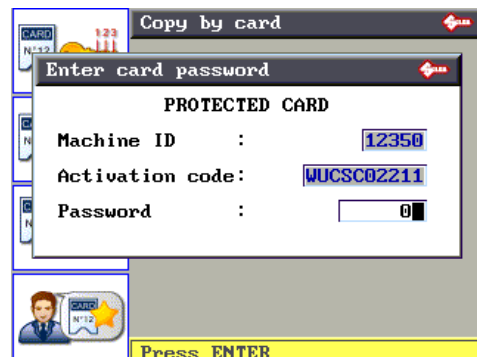
- **Machine ID 12345**

Visible in the password box.

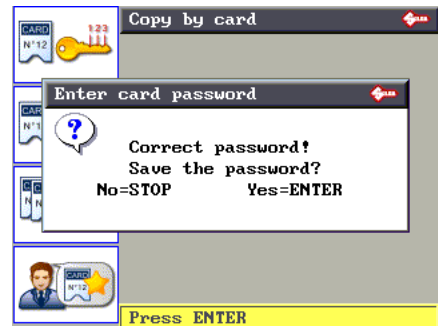
- **ACTIVATION Code WUCSC02211**

shown ONLY when access to protected data is attempted.

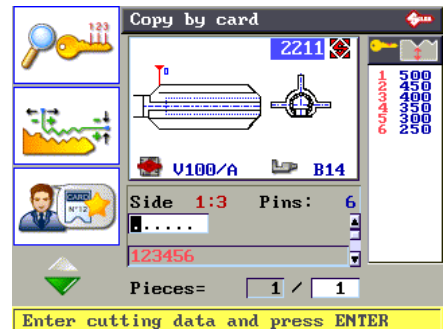
Once obtained, enter the password on the Password line, as shown in the example given.



If the correct password has been entered, the screen shows:



The password can be saved so that it need not be entered whenever the protected data card is used, or not saved so that access is limited only to the person in possession of the password.



5.6 PC QUEUE

• USE OF THE MACHINE WITH A PERSONAL COMPUTER

Taken for granted that the user is in possession of some Silca software, the following are the possibilities available.

The 'Silca Code Program' makes it possible to carry out searches by code for cutting data and to store the information in a special work queue (or file).

This is a special function which has been created to help those users who wish to work with a number of simultaneous searches. After having carried out a code search, the information is simply filed in the special work queue then everything is transferred to the UNOCODE 399 EVO.

The information transmitted by the Personal Computer cannot be altered manually. Each line transmitted corresponds to a stage in the cutting process for one or more keys.

As described above, for each cutting process transmitted the number of pieces to be cut is set, a '+' sign shows when the cycle is finished.

The '+' sign warns the operator that the last cutting operation has been carried out.

Should a work queue be interrupted, turn off the UNOCODE 399 EVO. When the machine is turned on again and the <PC queue> is called up, the list reappears, starting from the first line.

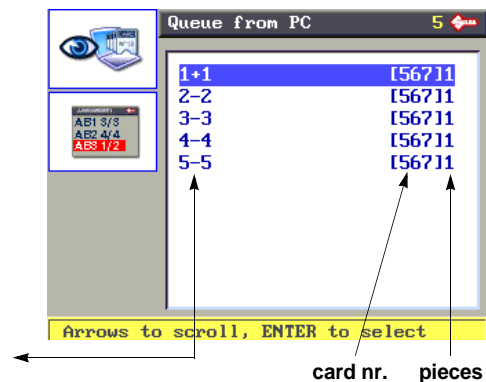
From the initial screen press F3 to enable the function.

• PC queue

The data received from the PC is presented as a list:

- No. of jobs received
- Indirect cutting code
- Silca cutting card No.
- No. of pieces to be cut.

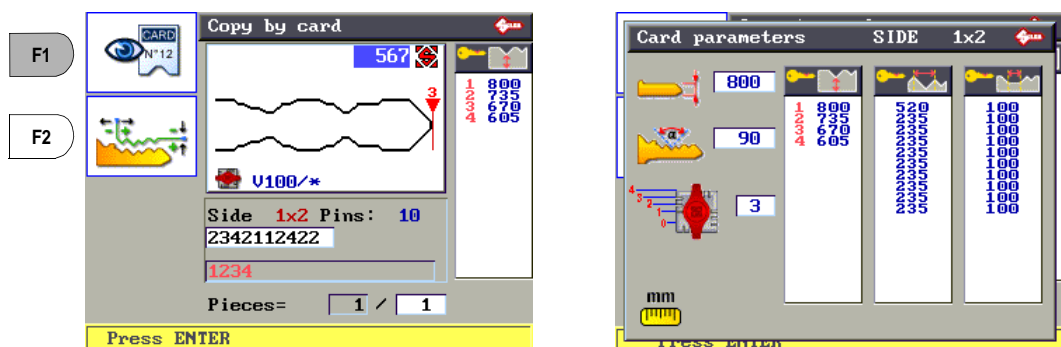
By means of the arrow keys (up and down) the user can select the job to be done and confirm with the ENTER key.



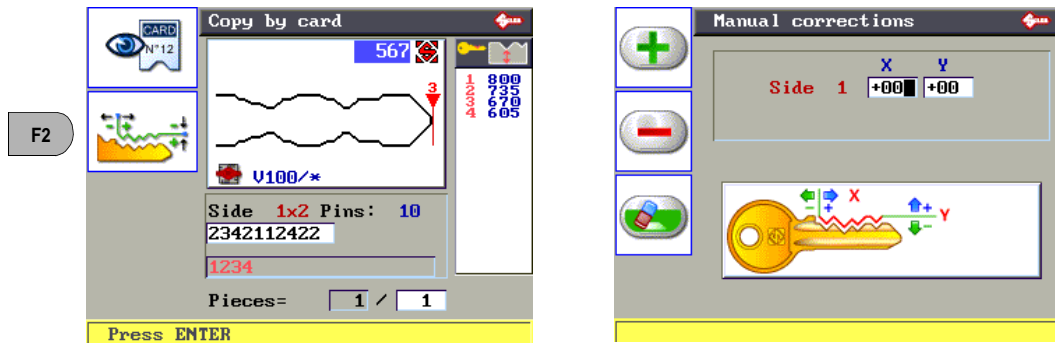
- The "+" sign indicates that the set key has been cut.
- The "-" sign indicates that the set key has not been cut yet.

Data for the job, received from the PC program, CANNOT be edited manually (except for Electrical contact and Key blank measurements).

For example, the following will appear on the display:

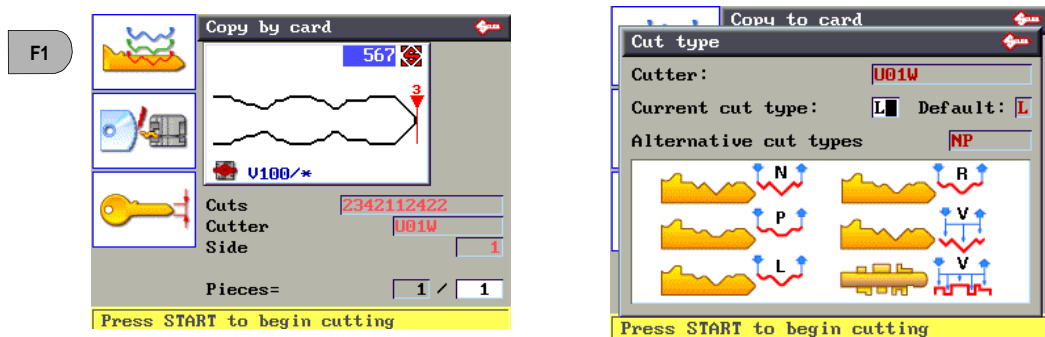


- Press F1 to see the cutting parameters on the card in question.

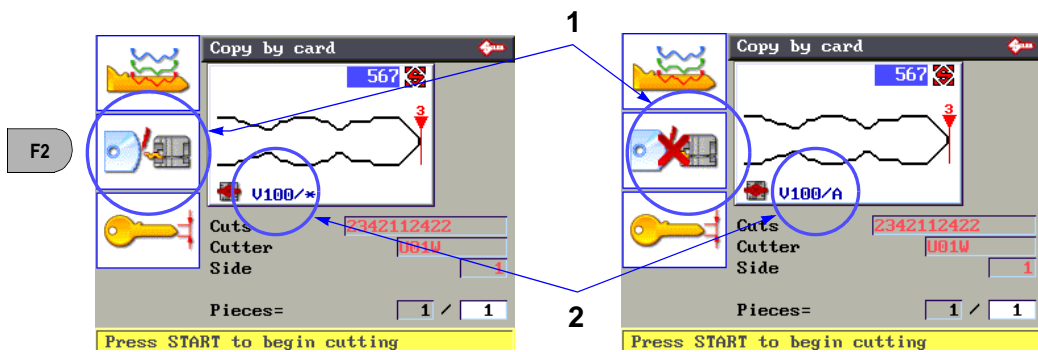


- Press F2 to view any manual adjustments set up by the PC program.

Press ENTER to continue, the display will show:



- Press F1 to view the cutting method set up by Silca for the card in question.



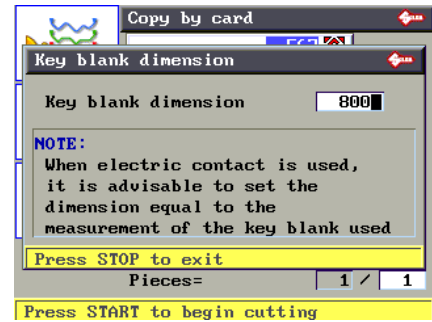
- Press F2 to enable or disable the electrical contact function for reading the key blank measurements.

1 - A red "X" on the electrical contact icon means that it has been disabled.

2 - The symbol (*) in the clamp field means that the key will be cut reading the key blank measurements by electrical contact.

Note: some cutting cards do not include electrical contact. In such cases the software does not allow editing.

Note: when electrical contact is used it is advisable to set key blank measurements that are the same as those of the key to be cut.



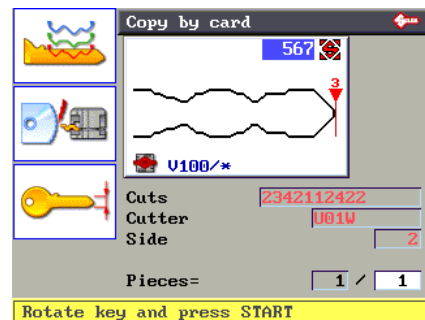
- Press F3 to vary the setting for the value of the key blank measurements.

Note: when electrical contact is used it is advisable to set key blank measurements that are the same as those of the key to be cut.

When the key blank has been fitted into the clamp on the cutter side and the safety shield is down, press START. The cutting process starts. The display will show:



When the first side has been cut, the display will show:



- Raise the safety shield and position the second side of the key to be cut.
- Lower the safety shield and press START, the display will show:



When the second side has been cut, the display will show:

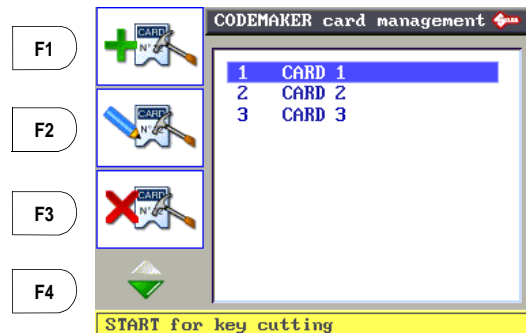


- Press STOP to finish the job.
- Press ENTER to continue cutting other keys with the same cuts as the key just finished.






5.7 CODE MAKER

The Code Maker function is used to create a new cutting card with user-definable cutting parameters. From the initial screen press F4 to enable the function.

The display shows a list of user-created cards (on a new machine the display is empty).



The functions included in CodeMaker are represented by the 4 icons on the left.

- Create new card (press F1 to start) 
- Edit a user-created card (press F2 to start) 
- Delete card created (press F3 to start) 
- Copy a user-created card (press F1 to start) 
- Copy a Silca data card onto CODEMAKER (press F2 to start) 



NOTE: Creating of new cards is allowed for two key types:

- SINGLE side
- DOUBLE SYMMETRICAL side

• Creating a new card with Code Maker

Assign a name (description) to the new card. All data except the card number can be edited.

Step 1

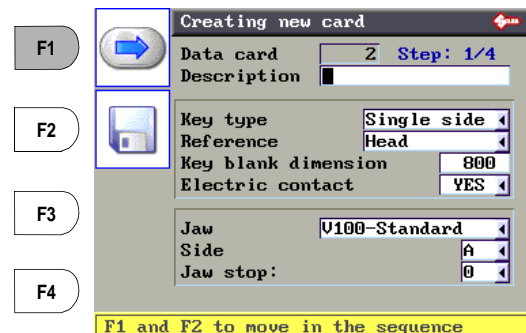
Operational keys (in Description field):

Left and right arrows: to move the cursor

SHIFT+ENTER: to insert a space

CLEAR: deletes a single character

SHIFT + CLEAR: press together to delete a whole line.



Once the values have been entered press F1 to continue. The display will show:

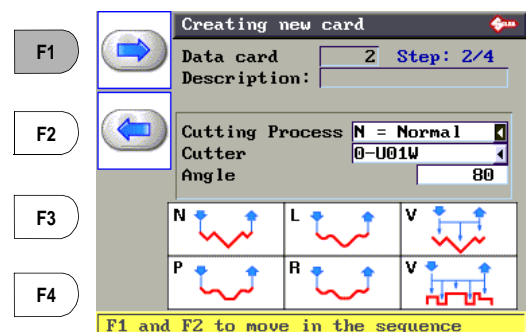
Step 2

This display screen can be used to edit:

- Type of cut (see chap. 5.5.1)
- Cutter (set automatically in relation to the type of cut)
- Angle (can be set for types of cut different from "V")

Note: press F2 to go back to the previous screen.

When editing is complete, press F1 to continue.



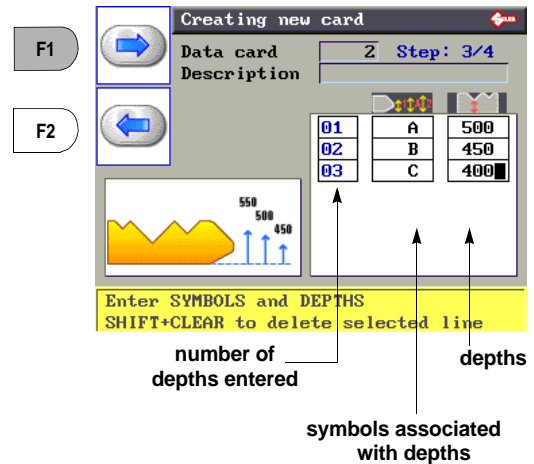
ATTENTION: for error messages caused by wrong use of Codemaker, see chap.5.12.4 "CODEMAKER messages", page 64.

Step 3

Enter the depth symbols (numbers or letters) and associate them to the required cutting depth. Press ENTER to confirm the value and go from one field to another. All measurements are expressed in hundredths of a millimetre or inches, according to the settings in the machine Options (chap.5.10, page 56)

Note: *press F2 to go back to the previous screen.*

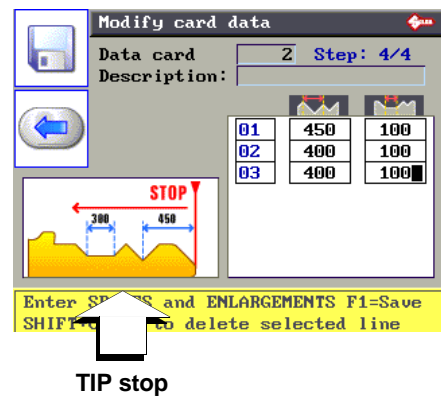
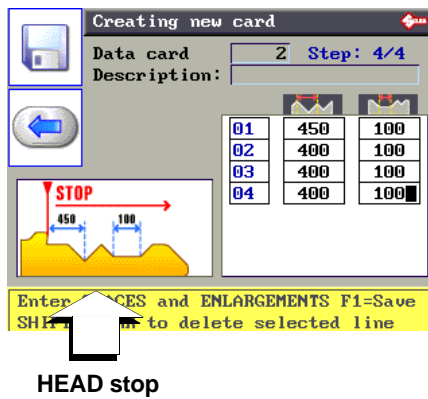
When editing is complete, press F1 to continue.



Step 4

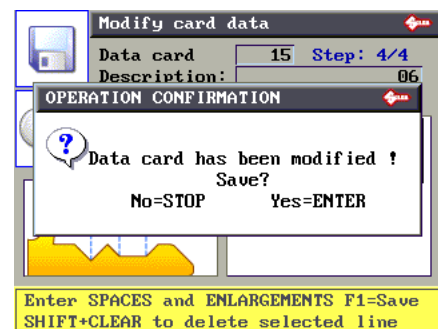
Enter the cutting space values, from the key stop to the centre of the first cut, then from the centre of the first cut to the centre of the second cut, and so on. The cut bases can vary from 0 to 200, which is the width of the base of the cut. All measurements are expressed in hundredths of a millimetre or inches, according to the settings in the machine Options (chap.5.10, page 56)

Note: *press F2 to go back to the previous screen.*



When editing is complete, press F1 to continue. The display will show:

- Press ENTER to confirm editing.
- Press STOP if you wish to return to the main menu without saving the data.



• Editing a card created by Code Maker

This function is used to edit a card previously created by Code Maker. Use the arrow keys to select the card to be edited.

- Press F2 for the editing controls.
- Follow the procedure described above.

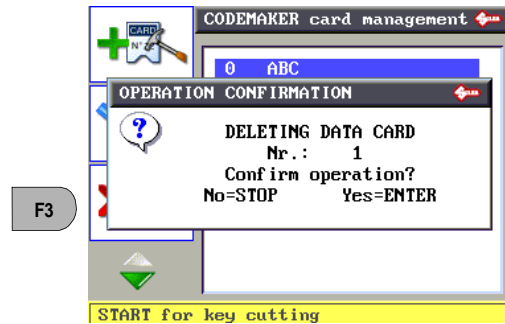
ATTENTION: *for error messages caused by wrong use of Codemaker, see chap.5.12.4 "CODEMAKER messages", page 64.*

• Deleting a card created by Code Maker

This function is used to eliminate a card previously created by Code Maker.

- Use the arrow keys to select the card to be deleted.
- Press F3 for the deletion control. The display appears as follows:
- Press ENTER to confirm deletion.
- Press STOP to stop the operation.

ATTENTION: when a card is deleted the number of that card cannot be reused.

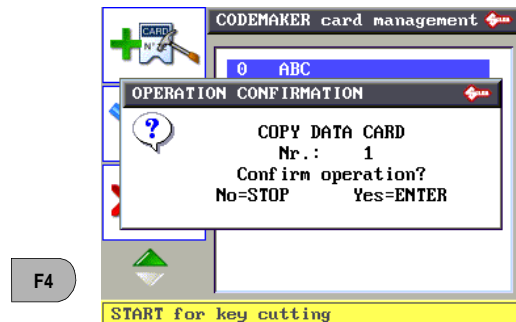


• Copying a card created by Code Maker

This function is used to speed up the creation of a new card.

- Select the card to be copied and press F4; the display will show a message asking whether to proceed.

Press ENTER to proceed. A screen appears showing the card to complete with a description and adjustment, if necessary, of any key and/or cutting parameters (see paragraph "Creating a card with Code Maker").



ATTENTION: for error messages caused by wrong use of Codemaker, see chap.5.12.4 "CODEMAKER messages", page 64.

5.8 GAUGING

The following components on the machine have a specific 'self-setting' procedure with the use of regulating templates (chap.1.5 "Accessories provided", page 8):

- CLAMPS
- CUTTERS

ADAPTERS provided as optionals do not require calibrating. However, if necessary adjustments can be made to the cutting data, according to the procedures described in chap.5.4 "Copy with adjustments", page 20.

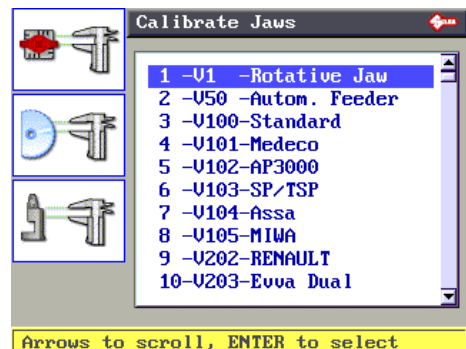
In the circumstances listed below (see events) it may be necessary to re-set one or all of the clamps and/or cutters that the user has in possession. This operation is semi-automatic and requires close attention to the instructions listed below.

EVENT	MACHINE ZEROES	CALIBRATION	
		CLAMPS	CUTTERS
Replacement of photocells	YES	YES	NO
Electronic board replacement	YES	YES	NO
Replacement of the Optical Reader unit	NO	YES	NO
Replacement of sensors	YES	YES	NO
Replacement of the cutter shaft	YES	YES	NO
Replacement of the ball screws	YES	YES	NO
Clamp replacement Cutter side (with a new one of the same type)	NO	NO	NO
Clamp replacement Lector side (with a new one of the same type)	NO	NO	NO
Re-sharpening of existing cutter and/or cutter replacement (with a new one of the same type)	NO	YES	YES
Installation of optional clamps	NO	YES (if applicable)	NO

From the initial screen press MENU then F1 to enable the function.



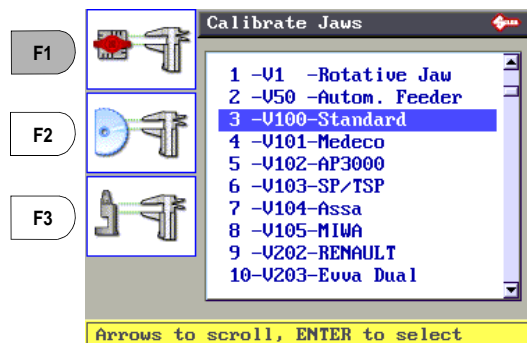
- Clamps ->
- Cutters ->
- Adapters ->



5.8.1 CALIBRATE JAWS

Press F1 to access the list of clamps.

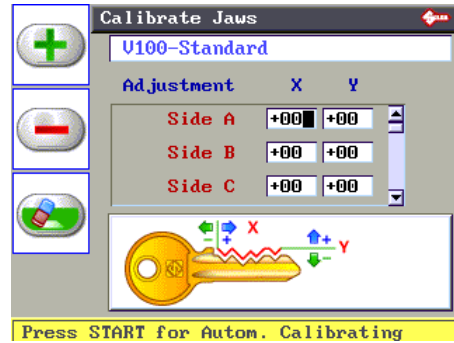
Use the up/down arrow keys to select clamp 3-V100, then press ENTER.



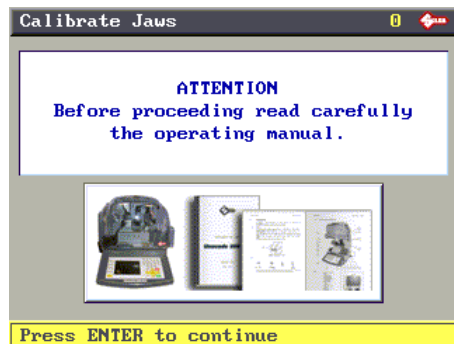
The display will show:

Some manual adjustments can be made from this screen.

ATTENTION: adjustments are made only if necessary and only after automatic gauging.

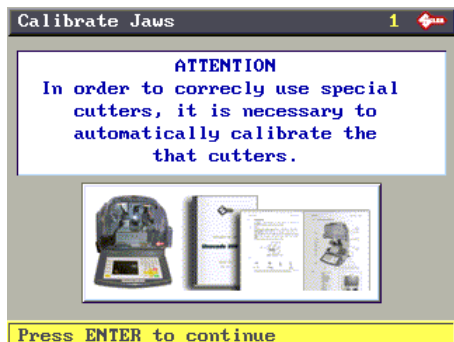


Press START to proceed with automatic gauging; the display will show:



ATTENTION: before gauging carefully read the operating flow below.

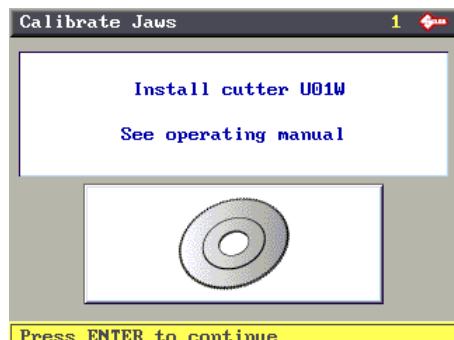
Press ENTER, the display will show:



Press ENTER, the display will show:

Make sure the U01W standard prismatic cutter is installed.

ATTENTION: If the original Silca U01W cutter is replaced with one that is NOT original or has been sharpened, it will be necessary to repeat clamp gauging and also gauge all the optional cutters.



Press ENTER, the display will show:

- Fit the test key blank (Z3 template) into side A of the left-hand clamp (Stop 0).

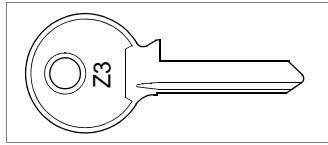


Fig. 26

- Lower the safety shield and press START. When cutting is complete the display will show:
- Fit the test key (Z3 template) cut and carefully cleaned into side A of the right-hand clamp (Stop 0).

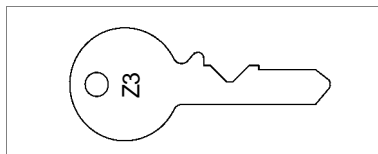


Fig. 27

- Lower the safety shield and press START. When reading is complete the display will show:
- Raise the safety shield, remove the Z3 template from the right-hand clamp and replace with a carefully cleaned Z20 template (Stop 0).

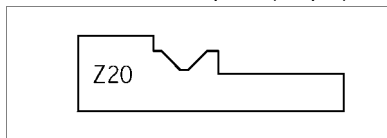
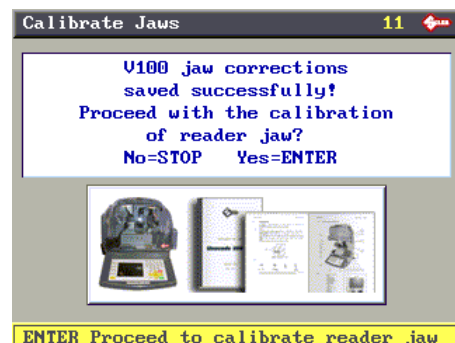
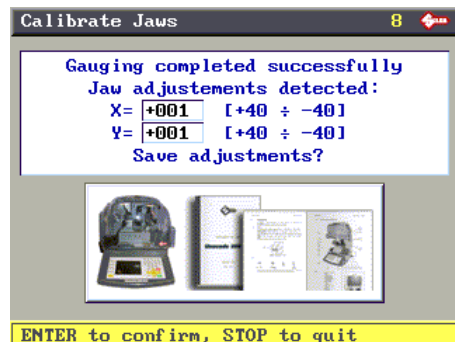
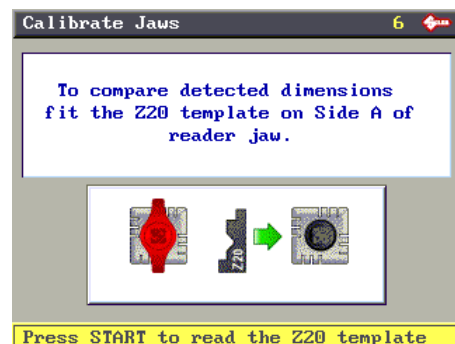
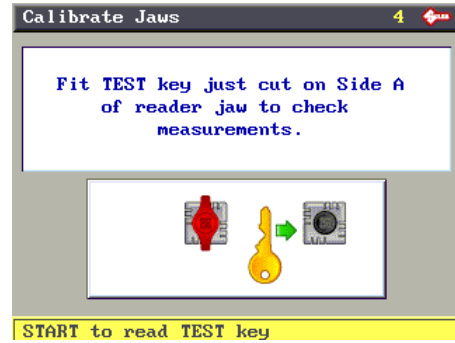
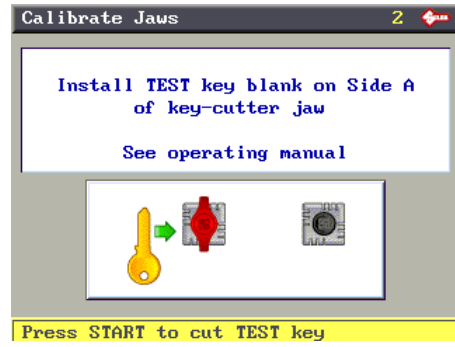


Fig. 28

- Lower the safety shield and press START.
- After an intermediate message "Reading template measurements" the display will show:
 - Press ENTER to confirm the data.
 - Press STOP to exit without confirming.

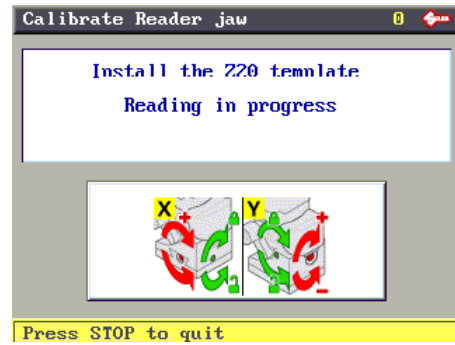
Note: acceptable value range: +/- 40 hundredths of a millimetre.

Press ENTER, the display will show:

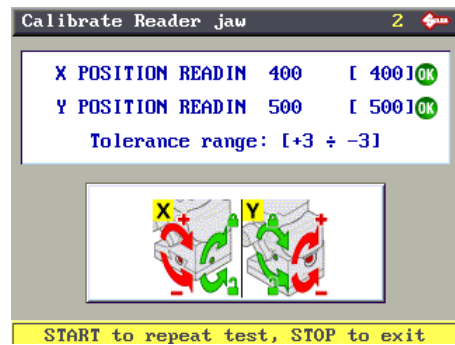


Press ENTER, the display will show:

As the Z20 template is already on the reading clamp, just press START.



After an initial message of "Reading" the display will show (example):



Note: discrepancies in X of +/-0.03 mm from theoretical measurements can be considered normal. Press STOP to confirm gauging without making mechanical regulations.

The X measurement read should be the same as the theoretical one (value= 400 in brackets).

If not, raise the safety shield and proceed as follows:

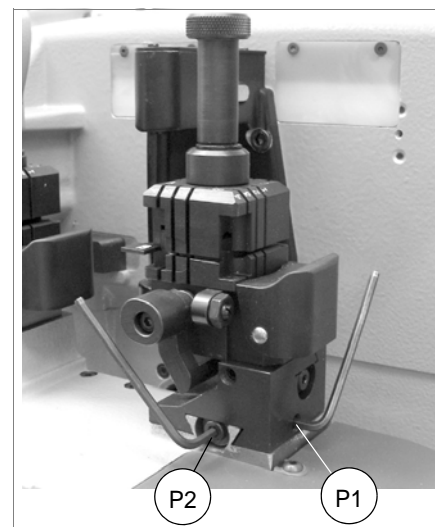
- For an X value lower than 400, loosen the grub screw (P1) and use a hex. wrench to tighten the screw (P2) (fig. 29).

ATTENTION: a quarter turn of the screw (P2) corresponds to a movement of approximately 19 hundredths of a millimetre.

- For an X value above 400, loosen the grub screw (P1) and use a hex. wrench to loosen the screw (P2).

ATTENTION: quarter turn of the screw (P2) corresponds to a movement of approximately 19 hundredths of a millimetre.

Fig. 29



The Y measurement read should be the same as the theoretical one (value = 500 in brackets).
If not, proceed as follows:

- For a Y value lower than 500, loosen the grub screw (P3) and use a hex. wrench to tighten the screw (P4).

ATTENTION:a quarter turn of the screw (P4) corresponds to a movement of approximately 19 hundredths of a millimetre.

- For a Y value above 500, loosen the grub screw (P3) and use a hex. wrench to loosen the screw (P4).

ATTENTION:a quarter turn of the screw (P4) corresponds to a movement of approximately 19 hundredths of a millimetre.

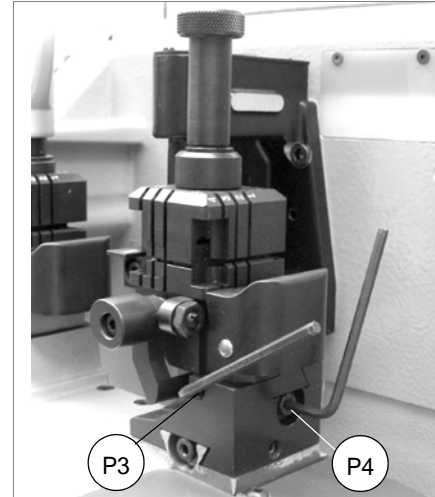


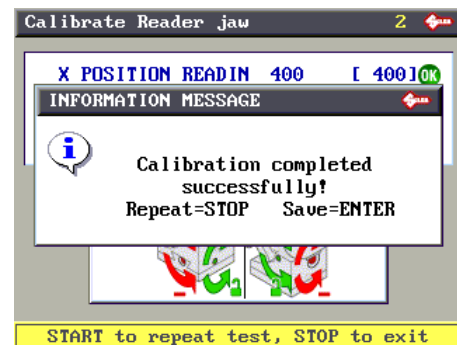
Fig. 30

Tighten the grub screw (P3), lower the safety shield and press START; repeat the operation until the right values of X and Y are set.

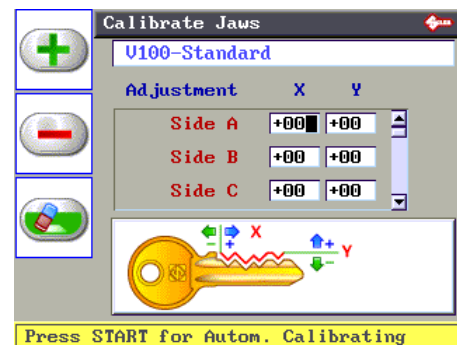
When the X and Y values are the same as the theoretical ones (in brackets or with errors between +/- 0.03mm) press STOP.

The display will show:

- Press STOP to repeat gauging.
- Press ENTER to confirm the gauging values read.



- Press ENTER to confirm the operation and return to the menu Calibrate jaw 3-V100-Standard.



Note: besides automatic gauging, the operator can make manual adjustments by entering the values in the X and Y parameters.

ATTENTION:such adjustments (if necessary) are to be entered only after automatic gauging, if applicable.

Adjustments can be made within a range of +30 and -30 hundredths of a mm.

- To adjust clamps and adapters the positive values of X will give the result shown.
- To adjust cutters, clamps and adapters the positive values of Y will give the result shown.

- Press STOP to go back to the main menu.

5.8.2 CALIBRATE CUTTERS

From the Gauging menu press F2 to enable the cutter gauging function.

With the up/down arrow keys select the U01W standard cutter and press ENTER.

The display will show:

- The positive or negative values are obtained by pressing F1 (+) or F2 (-).
- Press F3 to cancel the adjustments made.

Adjustments can be made within a range between +30 and -30 hundredths of a mm.

The “Automatic cutter calibration” function is used to gauge the optional cutters.

ATTENTION:automatic calibration is not available for the U01W cutter.

- If the original Silca U01W cutter is replaced with another Silca original, there is no need to repeat clamp gauging.
- If the original Silca U01W cutter is replaced with one that is NOT original or has been sharpened, it will be necessary to repeat clamp gauging and also gauge all the optional cutters.

5.8.3 CALIBRATE ADAPTERS

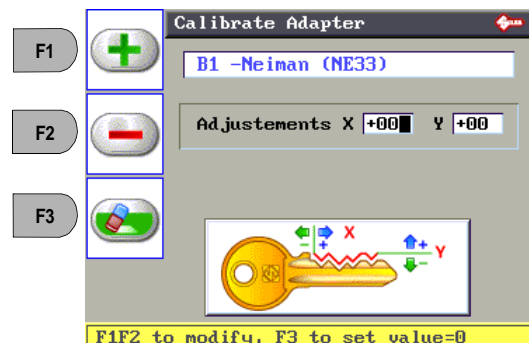
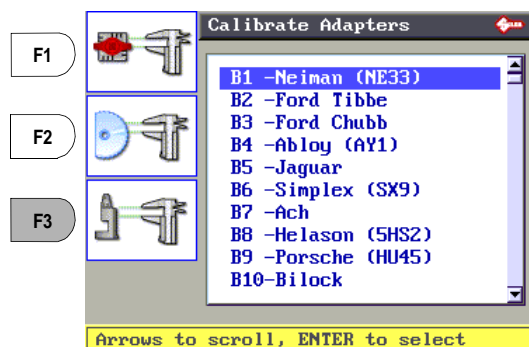
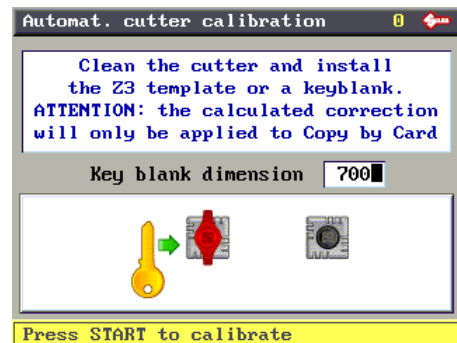
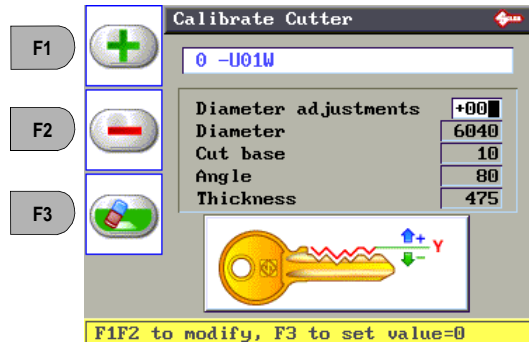
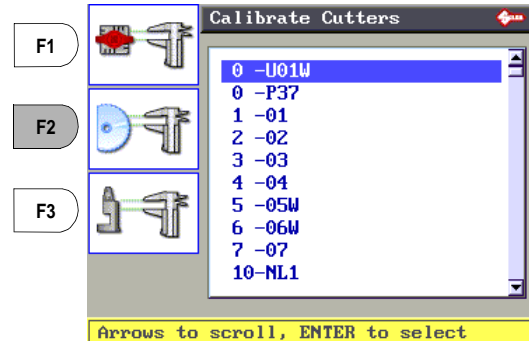
From the Gauging menu press F3 to enable the Adapter gauging function.

Use the up/down arrow keys to select the adapter to be gauged and press ENTER.

The display will show:

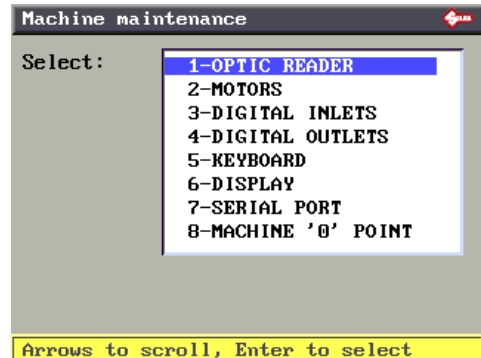
- Use the “right or left” arrow keys to change the adjustment field (X or Y).
- Positive or negative values are obtained by pressing F1 (+) or F2 (-).
- Press F3 to cancel the adjustments made.

Adjustments can be made within a range between +30 and -30 hundredths of a mm.



5.9 MAINTENANCE

From the initial screen press MENU then F2 to enable the function.
Use the up/down arrow keys to select the option and press ENTER, or directly press the key relating to the option number.

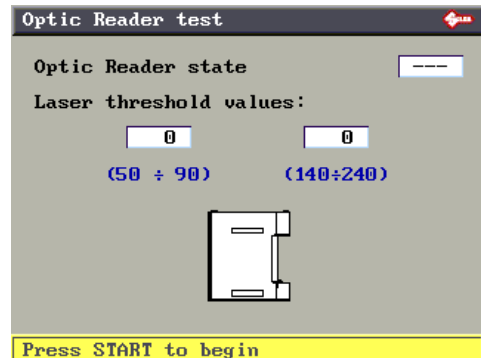


5.9.1 OPTIC READER TEST

Lower the safety shield and hold down the START button.

The status of the optic reader will go from --- to ON. If it goes to OFF it is faulty. The comparison levels will indicate values between 140 and 240 to the right and 50 and 90 to the left.

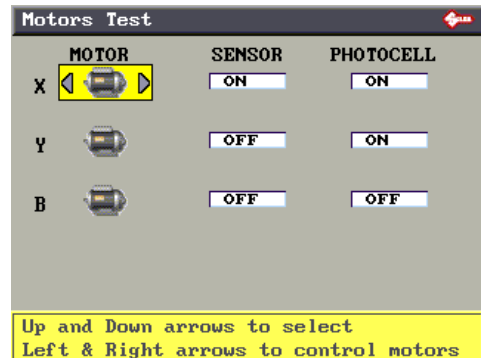
- If the value to the right is 255 it means the reader is faulty or the light beam is interrupted (check that there are no objects in the way of the conical slide). If the value to the left is 0 the reader is inactive. Contact Silca after-sales service.
- If the value to the left is higher than 90 clean the reader glass slide with a clean cloth.
- If the value remains over 90 (or lower 50) contact Silca after-sales Service.



5.9.2 MOTOR TESTS

Read the instructions on the display carefully and check that the carriage (or optional clamp in the case of B) for the axis involved moves.

ATTENTION: during this test function all end of run controls are deactivated; avoid moving the carriage up against its mechanical stops.



5.9.3 DIGITAL INLETS TEST

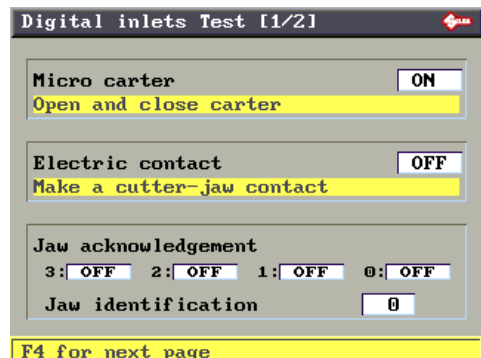
- Lift and lower the protective shield checking that the machine's display indicates OFF (with shield raised) to ON (with shield lowered).

Note: if the ON/OFF transition is not made, contact Silca's Technical Assistance Dept.

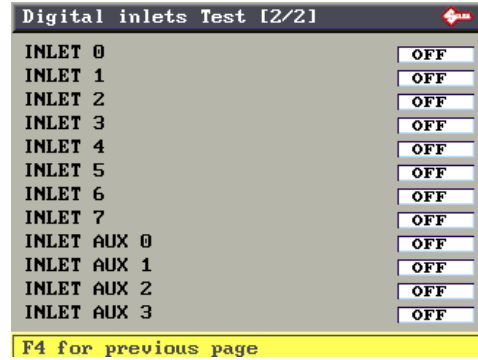
- Use any metal conductor to contact clamp to cutter, checking that the machine's display indicates OFF to ON.

Note: if the ON/OFF transition is not made, contact Silca's Technical Assistance Dept.

Jaw acknowledgement: operational only with electrically connected device.



This test can be carried out only when an automatic feeder (or other optional component) is installed on the machine.

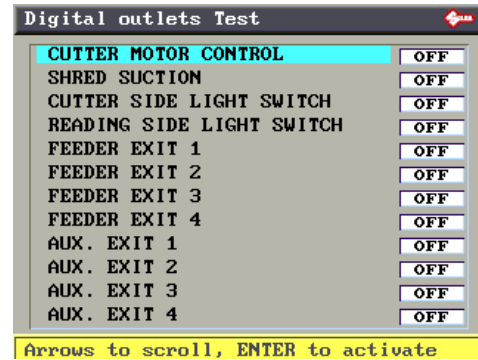


5.9.4 DIGITAL OUTLETS TESTS

Use the up/down arrow keys to move onto the required field, lower the safety shield and press START; it will go from OFF to ON.

- In the case of the cutter, the motor will also start.
- In the case of the cutting side or reading lamp, the one in question will illuminate momentarily.

Note: if this is not so, contact Silca's Technical Assistance Dept.

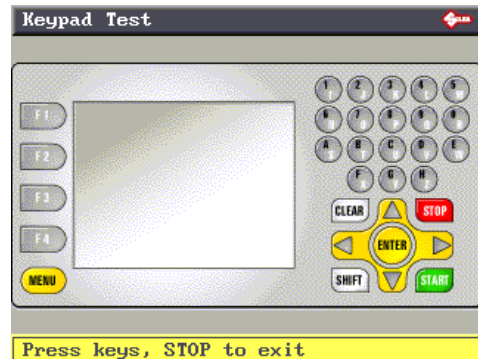


This test (Exit...) can be carried out only when an automatic feeder (or other optional component) is installed on the machine.

5.9.5 KEYPAD TEST

Press all keys (except STOP) one at time and verify that for every key pressed the display shows the same key circled. Press STOP at the end of the operation to quit the test.

Note: if this is not so, contact Silca's Technical Assistance Dept.

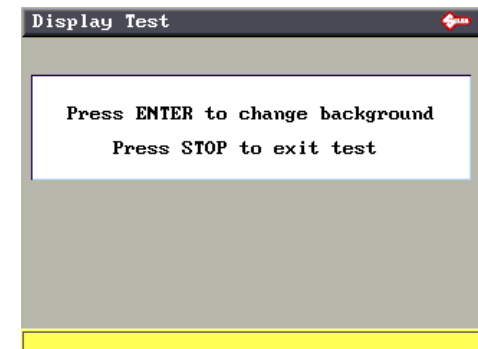


5.9.6 DISPLAY TEST

Press ENTER repeatedly to verify changes in the background colour.

Note: if no changes are noticed, contact Silca's technical assistance department.

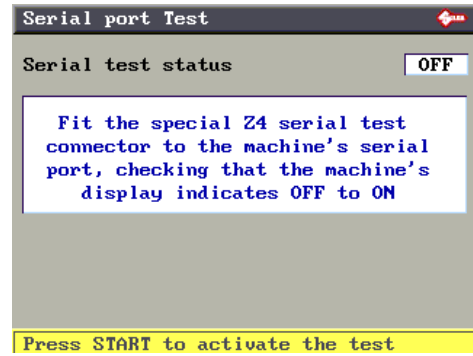
Press STOP to exit Test.



5.9.7 SERIAL PORT

Check that the machine's display indicates OFF.
 Fit the special (Z4) serial test connector (accessories provided) to the machine's serial port.
 Press START and check that the machine's display indicates OFF to ON.

Note: *if the ON/OFF transition is not made, contact Silca's Technical Assistance Dept.*

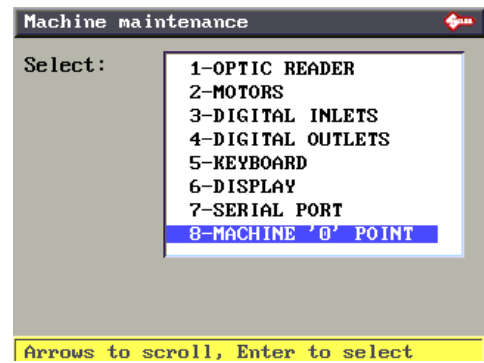


5.9.8 MACHINE ZERO POINTS

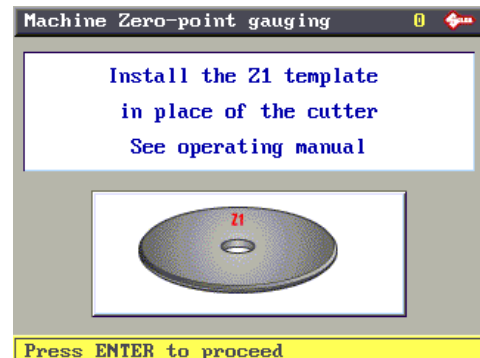
With the use of regulating templates (chap.1.5 "Accessories provided", page 8) the machine provides a 'self-setting' procedure. These procedures must be carefully carried out following the descriptions and illustrations indicated below.

The table below indicates the situations where the Machine Zeroes function must be activated.

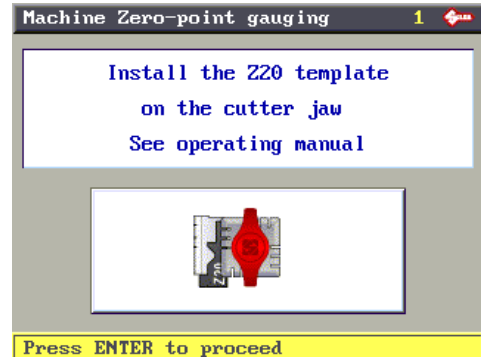
EVENT	MACHINE ZEROES	CALIBRATING	
		CLAMPS	CUTTERS
Replacement of photocells	YES	YES	NO
Replacement of the electronic board	YES	YES	NO
Replacement of the Optical Reader unit	NO	YES	NO
Replacement of sensors	YES	YES	NO
Replacement of the cutter shaft	YES	YES	NO
Replacement of the ball screws	YES	YES	NO



Fit the template (Z1) in the place of the cutter; (to remove the cutter read the instructions in chap.7.3).



Press ENTER to continue, the display shows:

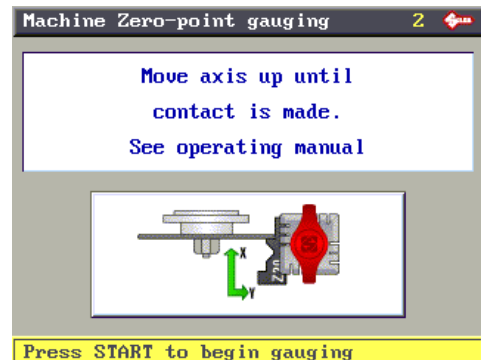


Read the instructions on the display and fit the Z20 template into the cutter side of the clamp, with Stop 0 as the reference.



Fig. 31

Lower the gauge and press ENTER to continue. The display shows:



Read the instructions on the display, move the carriages manually so that the Z20 template is taken into contact with the Z1 template (fig. 32) in the vertical zone after the stop, up against the front and up against the stem.

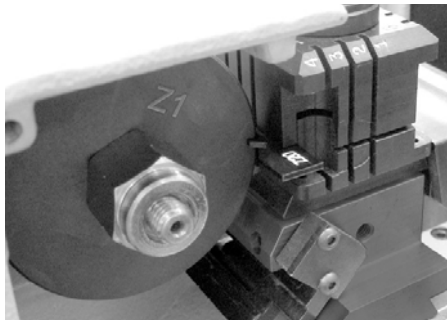
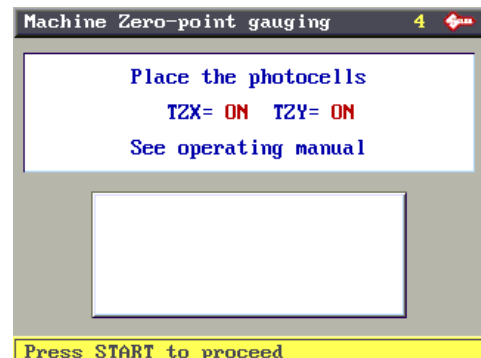


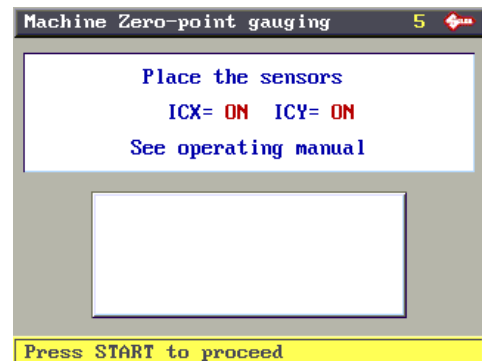
Fig. 32

When the given position is reached, lower the safety shield and press START. First the display will show: "Positioning" (**)

And then:



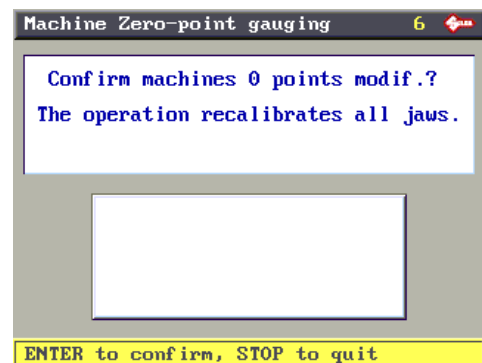
Press START, the display will show:



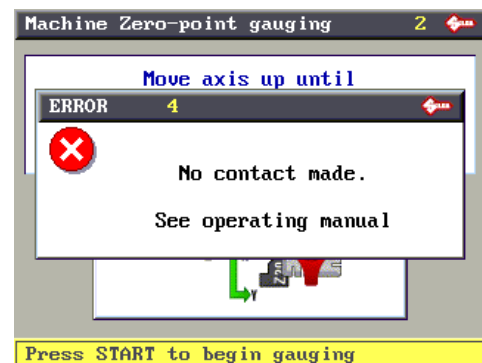
Press ENTER to confirm, only if the previous parameters were ON (**).

Press STOP to cancel the operation and not confirm the adjustments made (if there is one value or more on OFF). The previous values remain valid (already in the machine's memory).

ATTENTION: if the STOP key is pressed, the new settings will be lost. If so, only the previous setting values will remain valid.



(**) If the templates have not been properly positioned the following ERROR message appears:



(***) If one or both the photocells or one or both the sensors are OFF, repeat the operation following the procedure described in chap. 5.9.9, page 53.

5.9.9 PHOTOCELLS AND SENSORS REGULATION

PRELIMINARY OPERATIONS

- 1) turn the machine off and unplug it from its power supply cable.
- 2) remove the back panel (chap.7.8).
- 3) loosen the (G1) and (G2) grub screws that secure the X axis photocell disk (fig. 33).
- 4) remove the bottom panel (chap.7.9).
- 5) disconnect the (J1) Y axis cable from the carriage (fig. 34).
- 7) unscrew the 3 (B5) fixing screws and remove the Y axis protective cover by pulling it in the direction shown in fig. 35.
- 8) plug the Y axis (J1) cable.
- 9) turn the machine on and carry on with the procedures described on page 54 .

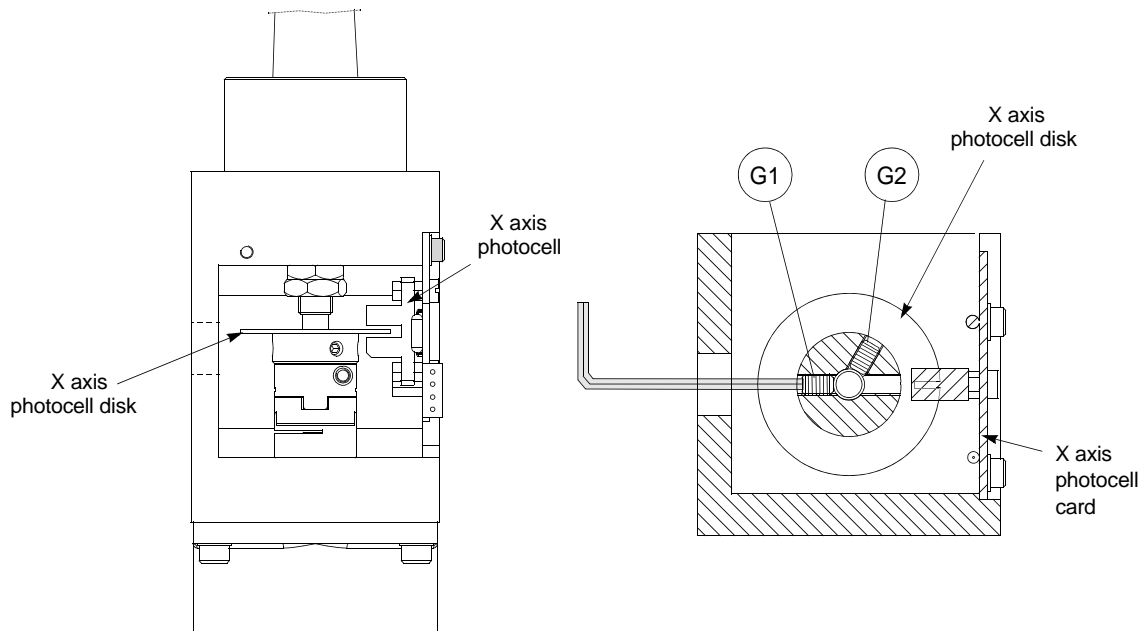


Fig. 33

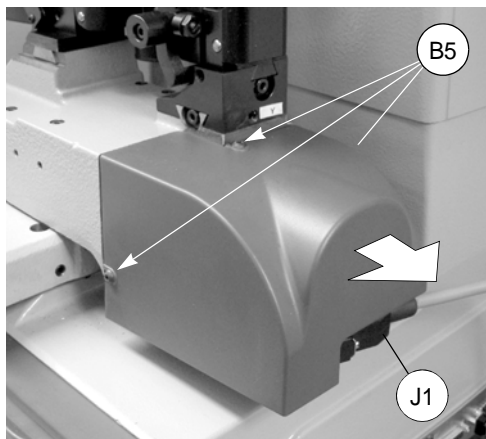
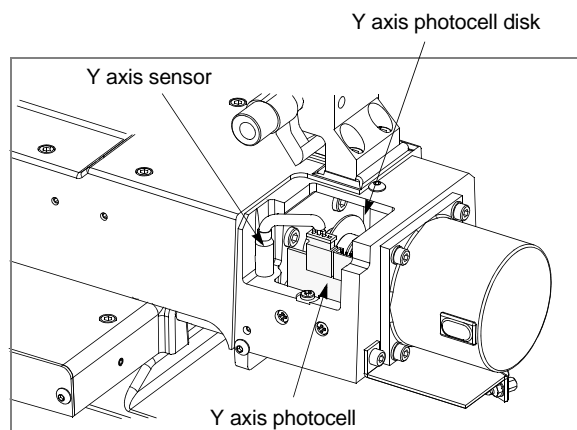


Fig. 34



- the machine will take the X and Y axes to a predefined position.
- the operator must manually rotate the X and Y photocell disks up until the cut in the disks face the photocells card.

Y axis photocell:

- manually turn the Y axis disk (fig. 35) up until the display's description changes from OFF to ON.
- use the provided allen key to tighten the (G3) grub screw.

X axis photocell:

- manually turn the X axis disk (fig. 33) up until the display's description changes from OFF to ON.
- use the provided allen key to tighten the (G1) grub screw (fig. 33).

9) lower the protective shield.

10) press START.

- the machine goes on to a new position and is ready for regulating the sensors.

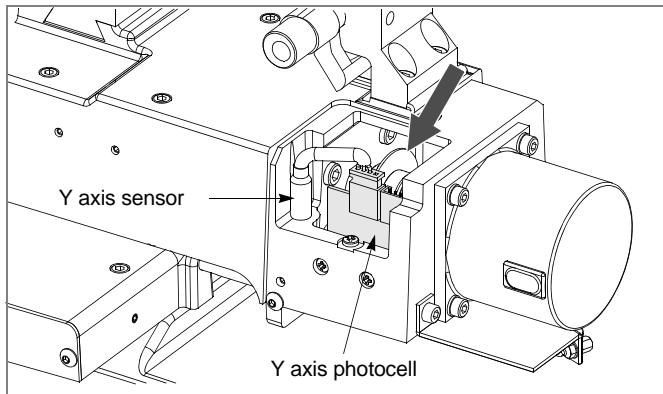
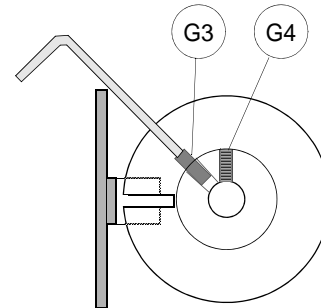


Fig. 35

**Regulating the Y axis sensor:**

- raise the protective shield.
- use the provided allen key to loosen the (C1) grub screw; manually rotate the (C2) rod in both directions up until the changeover point from OFF to ON is found.
- tighten the (C1) grub screw to secure the rod.

Regulating the X axis sensor:

- carefully tip the machine over.
- remove the bottom panel by unscrewing all 8 securing screws.
- loosen the (C3) screw that secures the sensor support plate. Manually move the sensor support plate up until the display's description goes from OFF to ON.
- tighten the (C3) screw to secure the plate back into place.
- re-position the machine back on its workbench and lower the protective shield.
- press START.

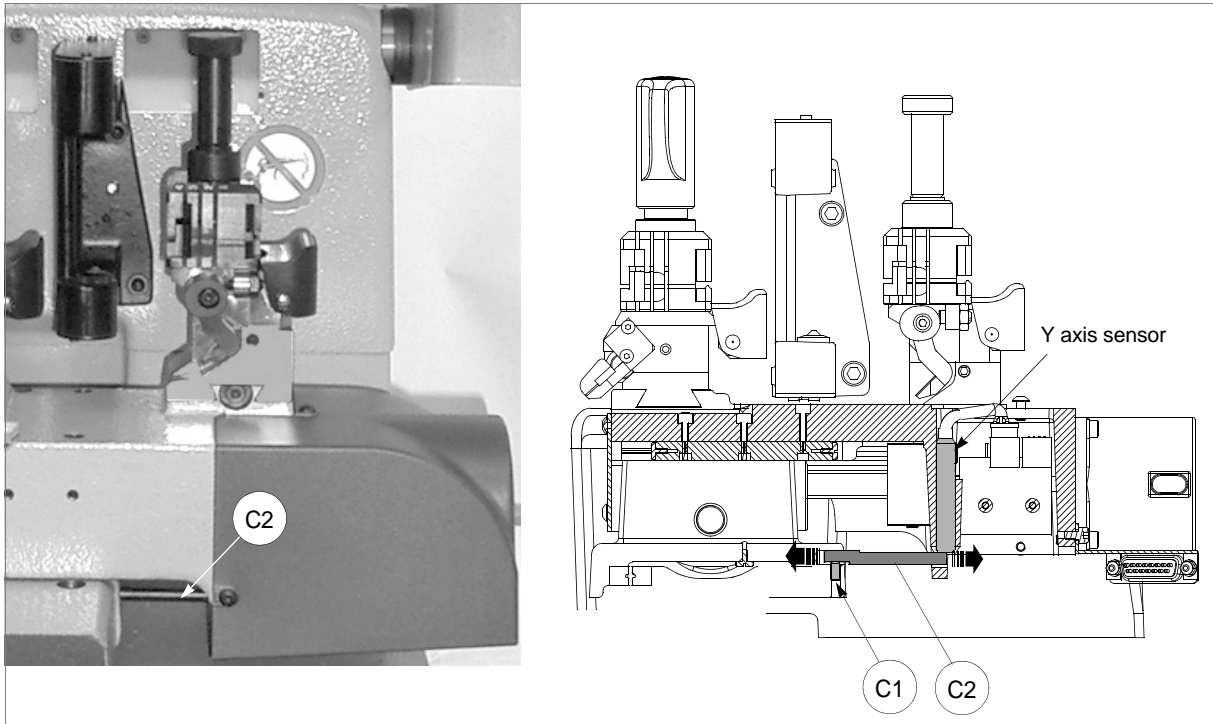


Figura 36

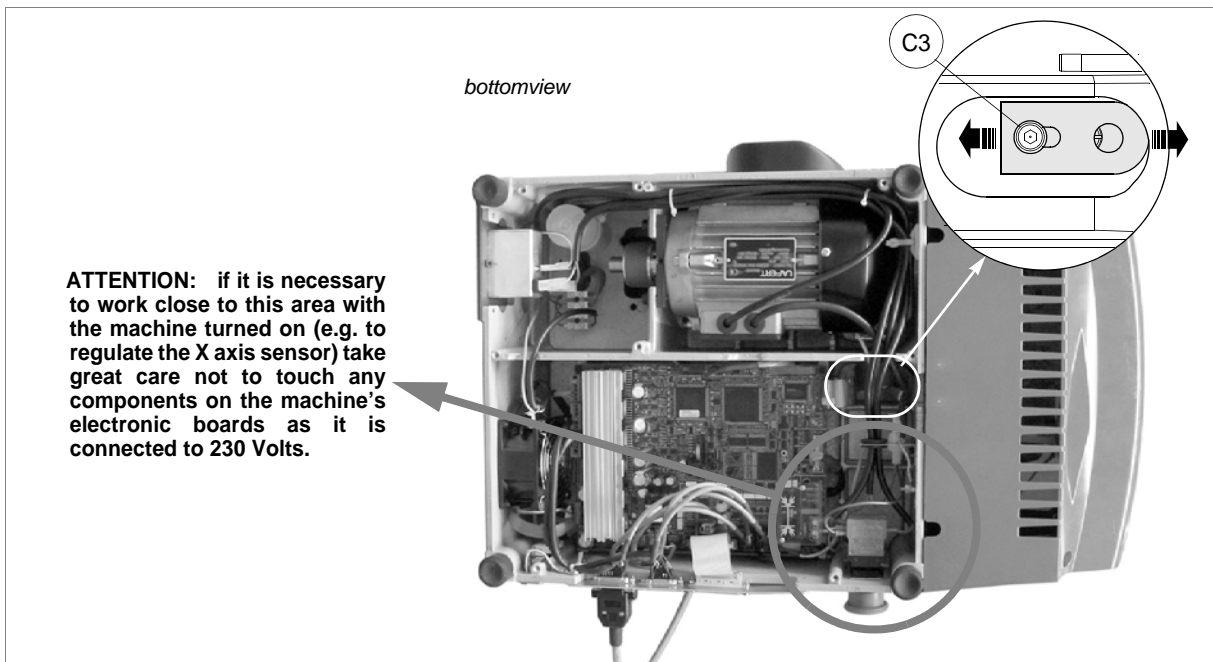


Figura 37

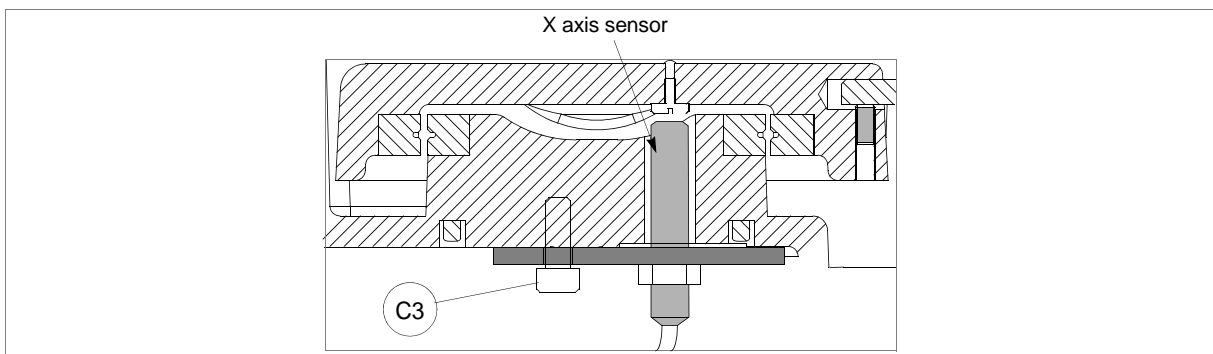


Fig. 38

5.10 OPTIONS

From the initial screen, press MENU then F3 to enable the function.
There are 4 machine option windows that are selected by pressing F4.

ATTENTION: Hold down F4 to take the machine back to its initial state (with the original parameters set by Silca).

Machine Parameters/Options that can be forced from the original factory setting:

Rapid speed: 4000
Cutting speed: 400
Reading speed: 350
Minimum distance from stop: 50
Stop adjustment enabling: 0 → Disabled
Parameter X stop adjustment: 0
Parameter Y stop adjustment: 300
Parameter H stop adjustment: 370
Parameter L stop adjustment: 0
Measuring unit: 0
Electric contact enabling: 1 → Enabled
Date format: 0 → GG/MM/AA
Time format: 0 → 0-24
Keyboard Inversion: 0 → Disabled
Cutting check: 1 → Enabled
Rapid menu for PC queue: 0 → Disabled

Machine Options [page 1/4]

The display shows: **Preferences**

Current language:

use the arrow keys (rh/lh) to select the measuring unit required (mm = millimetres, inches) then press ENTER to confirm.

Measuring unit:

use the arrow keys (rh/lh) to select the measuring unit required (mm = millimetres, inches) then press ENTER to confirm.

Key pad inversion:

this function is normally disabled. Use the arrow keys (rh/lh) to select enabled or disabled then press ENTER to confirm.

The operation is used to invert the function of the alphanumerical keys.

With “Key pad inversion” disabled:

- To digit number 3 press 3/K
- To digit the letter K: press SHIFT + 3/K

With “Key pad inversion” enabled:

- To digit number 3: press SHIFT + 3/K
- To digit the letter K: press 3/K

Cutting control:

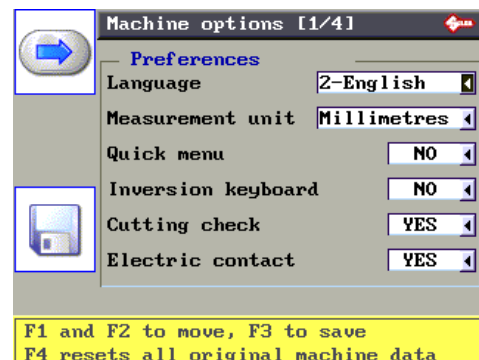
This option is used to enable and disable control of the combinations entered on the cutting card, by pressing SHIFT + [up arrow].

Default is enabled, i.e. there is constant control that the combination entered is compatible with the cutting path.

Such control has certain rules that prevent the operator from creating keys which are not guaranteed to work.

Electrical contact:

This function is normally enabled. Use the arrow keys (rh/lh) to select enabled or disabled then press ENTER to confirm (chap.4.2, page 15)



Machine options [page 2/4]

the display shows: **Machine data**

Model:

machine model.

Serial No:

the serial number corresponding to that on the ID plate located on the back of the machine.

Keys cut:

cutting completed.

Operating System Version:

version of the machine operating system.

Carriage speed

Fast speed:

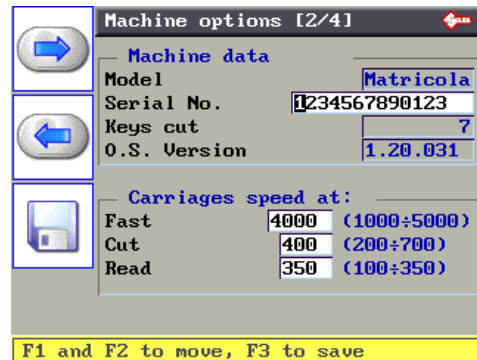
the speed at which the carriages approach the cutting zone before cutting is started. The set speed is that for ideal conditions, but the operator can change it from a minimum of 1000 to a maximum of 5000.

Cutting speed:

corresponds to the speed at which the carriage advances during key-cutting. The set speed (400) is that for ideal conditions, but the operator can change it from a minimum of 200 to a maximum of 700.

Reading speed:

Recommended reading speed is 350; the operator can change from a minimum of 100 to a maximum of 350.



Machine options [page 3/4]

The display shows: **Head stop processing**

Min. cut distance:

The number shown on the machine's display represents the X axis distance between the key blank shoulder and the beginning of the first cut (fig. 39).

This function is extremely important with keys that require cuts on both sides as it ensures precise positioning on the key 2nd side.

The set figure is 50 hundredths of a mm, which can be varied between min.0 - max. 90 hundredths of a mm.

ATTENTION: settings that are too high may render precise cuts impossible, with the following message on the display:

MIN. Parameter of
DISTANCE FROM STOP
is incompatible with
selected card!

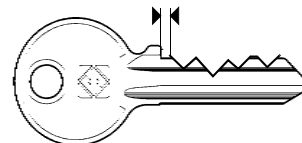
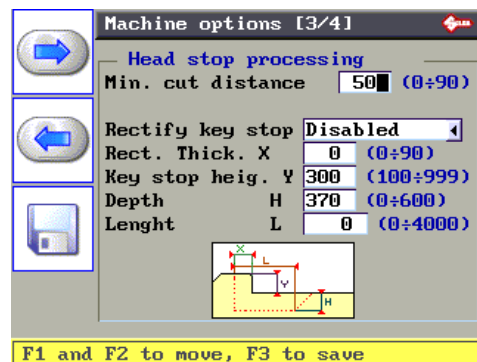


Fig. 39

Rectify Key Stop:

The machine does not normally allow for key stop rectification.

However, it is possible, when necessary, to rectify the stop by removing a part of it, and arrange cutting according to the new key stop created.

If the operation is enabled, 4 items are required:

Rectification thickness X:

thickness of the part to be removed, quantified in hundredths of a mm (min. 0 - max.90)

Key stop height Y:

height of the stop read by a gauge on the key, quantified in hundredths of a mm. E.g.: Y = 3 mm = 300 hundredths of a mm (min.100 - max.999).

Depth H:

depth of the part to be removed, quantified in hundredths of a mm, relating to the key blank measurements (min.0 - max.600).

Length L:

distance in hundredths of a mm of the axis from the cutter, relating to X (min.0 - max.4000).

Machine options [page 4/4]

The display shows: **Clock management**

Date and time format:

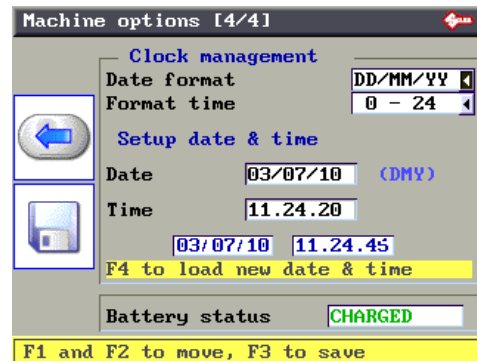
use the arrow keys (rh/lh) to select the DATE format (DD/MM/YY by default, or MM/DD/YY or YY/MM/DD) and TIME format (0 - 24 by default or am - pm) required, then press ENTER to confirm.

Setup date and time:

use the up/down arrow keys to enter the field to be edited and use the arrow keys (rh/lh) to go to the item to be edited. Edit with the numerical keys and press ENTER to confirm each item. Press F4 for overall validation of the edited string. The same preset data will also be shown along the bottom.

Battery status: CHARGED

Automatically reads whether the battery is charged or flat. The battery is used exclusively for the date function.



5.11 ENABLING

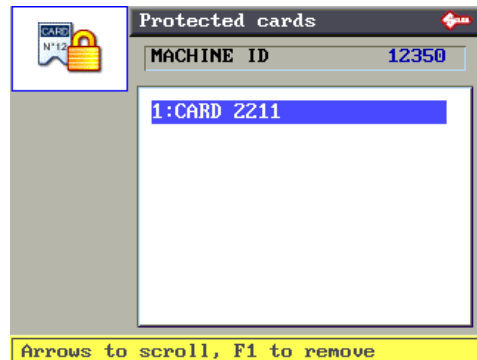
From the screen, press MENU and/or F4 to enable the function.

This display shows all the protected systems enabled and allows them to be protected again, if necessary.

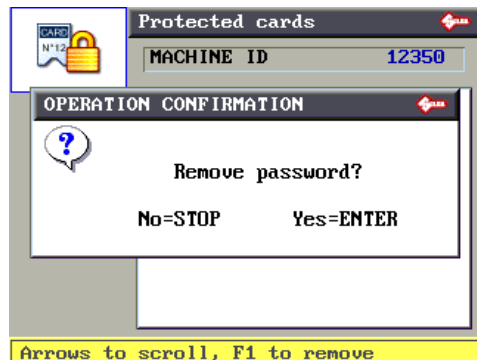
E.g.:

In this case a single protected card has been previously enabled.

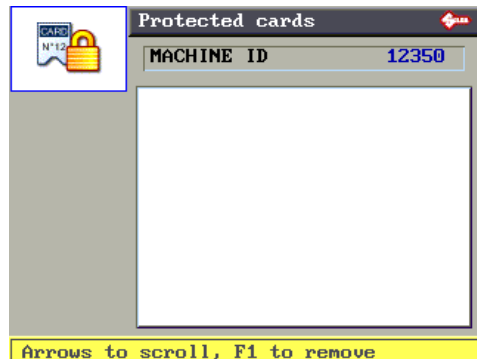
As explained on the display, use the arrow keys (up and down) to select the enabled protected system. Press F1 to make it protected again.



The display shows a further message requiring confirmation of removal. Press STOP to quit the operation without making alterations, press F1 to protect the selected card.



the display will show:



5.12 MESSAGES

5.12.1 ATTENTION MESSAGES

Data card
not available!

- The entered data card number is not available in the machine's data base.

Non-feasible
combination!

- The entered cuts cannot be carried out (see chap.5.5.1, page 32).

ATTENTION!!
Install cutter:
U01W

- This message appears when the cutter must be changed with one that is compatible to the type of cuts required for the entered data card number.

Clamp not
available!

- This clamp is not available in the machine's data base.

Cutter not
available!

- This cutter is not available in the machine's data base.

Adaptor not
available!

- This adapter is not available in the machine's data base.

Type of cut
not available!

- The entered data card number requires a type of cut that is not available in the machine's data base.

MIN. Parameter of
DISTANCE FROM STOP
is incompatible with
selected card!

- The minimum distance from the key stop position overlaps the first cut on the key (chap.5.10, page 56).

ATTENTION
Depth limit
exceeded!

- During the cutting cycle one or more depth exceeded the maximum limit. These depths are automatically aligned to the maximum permitted depth.

Non-feasible
function !

- Indicates that the entered function is not yet available.

Jaw
not calibrated !

- This message appears when the calibration data are not on the machine.

Data format
not compatible!
See operating manual

- This message appears when the data are not compatible with the data structure.

Zero point axis
Movement
not completed!

- This message appears when axis clearance has not been successful.

Modifications are only
applied to COPY BY CARD
and COPY WITH
ADJUSTMENTS

- Indicates that the adjustments inserted can only be applied to the two cases and not to Copy from original.

Resetting of original machine
data Confirm operation?

No=STOP Yes=ENTER

- This message appears if you wish to reset the machine on the initial settings, i.e. with the default parameters set up by Silca (see chap.5.10, page 56).

5.12.2 ERROR MESSAGES

ERROR 1
Key not
properly installed!

- This message appears when the cutter is unable to identify the keys measurements when cutting by means of electric contact.

ERROR 2
key gauge out
of place!

- During the reading or decoding cycle the machine's optical reader verified that the key gauge had not been lowered.

ERROR 3
Exceeded setting
tolerance limit
See operating manual

- The automatic setting revealed a variation that exceeded the permitted nominal figure setting reference. Carefully repeat the setting procedure.

ERROR 4
No template
contact made.
See operating manual

- During the setting of the "machine's zero points" there is a contact failure between the two templates (see chap.5.9.8, page 50).

ERROR 5
Key cannot be
copied

- This message indicates that during the reading cycle an anomalous form has been revealed that cannot be reproduced with the cutters provided.

ERROR 6
Machine ID
not defined
See operating manual

- The Machine ID has not been set. In such cases access cannot be gained to Protected Systems until the Machine ID is set. Select menu 5.11 "ENABLING" and check that the Machine ID is different from 0. To set Machine ID ask for a Software update valid for your machine and install with the SILCA WinTransfer Program or SILCA Code Program.

5.12.3 ALARM MESSAGES

ALARM 1
OPTICAL READER
E R R O R
See operating manual

- This message indicates that there is a fault in the optical reader or that something is obstructing its laser beam before starting the reading or decoding cycle.

ALARM 2
TEMPERATURE ALARM
Turn the machine off!

- The electronic control board has exceeded the maximum permitted temperature. Check the cooling fan (SEE chap.7.1 "Trouble shooting", page 67).

ALARM 3
I/O POWER ALARM
Check fuse F4!

- Indicates that the fuse has blown due to a short circuit in an inlet or outlet (see chap.7.1 "Trouble shooting", page 67).

ALARM 4
DIGITAL OUTLET
PROTECTION ALARM
Turn the machine off!

- Indicates a short circuit in port P (IN/OUT) (see chap.7.1 "Trouble shooting", page 67).

ALARM 5
CUTTER MOTOR
ALARM
Check fuse F1!

- Indicates that the fuse has probably blown (see chap.7.1 "Trouble shooting", page 67).

ALARM 6
CUTTER MOTOR
Fault on motor circuit!

- Indicates a fault on the electronic control board.

Faulty contact made!
Press START to move
axis at zero point.

- This message appears when the machine detects an unexpected contact.

Before calibrating the jaw:
V...
it's necessary to have
calibrated the V100 jaw

- This message appears when gauging a clamp that requires the previous gauging of the standard V100 clamp.

5.12.4 CODEMAKER MESSAGES

Key Blank dimension
out of range!
Limit values:

- Appears when the depth value exceeds the key blank measurement assigned to the key.

Cutting angle out of range!
Limit values:

- Appears when the set angle is higher or lower than the limit allowed by the cutter in use.

Cutting Depth out of range!
Limit values:

- Appears when the set depth is higher or lower than the limit for the clamp in use.

Spacing value out of range!

- Appears when the value of a set space is not within the limit.

Base of cut out of range!
Limit values:

- Appears when the value of a set flare is not within the limits.

Cutting process exceeds
X axis carriage range !

See operating manual.

- The set combination of spaces and flares exceeds the maximum run allowed for the space axis.

Overlapping base of cut!

- Appears when the value of a set flare would overlay a previous flare.

Spacing values
are not compatible
with base of cuts!

- Appears when the value of a space is altered in such a way as to cause the flare to overlay the previous one.

The cut depth is not compatible with cutting edge of the cutter.
See operating manual.

- Appears when the cutting depth would not allow the cutter to move sideways.

The cut depth exceeds the safety limit of the selected jaw side!
See operating manual.

- The depth exceeds the limits established for the clamp side in use.

The cutting process is incompatible with the STOP position !
See operating manual.

- Cutting cannot be done for the type of stop set.

The depth values can't be greater than the Key Blank Dimension
See operating manual.

- Appears when the key blank measurement is altered and the depths exceed such measurement.

6 CLEANING

- **keep the operational parts of the machine as clean as possible by brushing away the chippings in areas where they accumulate during cutting operations.**
- **under no circumstances must compressed air be used to clear the work zone of chippings as this will blow them onto the moving parts.**
- **Never use oil-based products or solvents to clean painted surfaces, jaws, electric or electronic connections, display and/or safety screens.**
- **Do not use alcohol to clean plexiglass carters and display.**

7 MAINTENANCE

ATTENTION: for repairs or replacement of parts for maintenance, the 'CE' mark is guaranteed only if original spare parts provided by the manufacturer are used.

Although the UNOCODE 399 EVO key-cutting machine does not require special maintenance, it is advisable to check and, if necessary, replace the parts subject to wear and electric/electronic parts (fuses, circuit boards, etc.) in the event of faulty operation.

ATTENTION: for normal servicing of the burnished mechanical parts, we recommend using lubricants or protective oil, e.g. WD40 or similar. Do not apply to the parts used for electrical contact (clamps, decoders, cutters, gauging templates, etc.). Do not contaminate the electronic parts with the oil.

Replacement is simple and can be carried out by the operator consulting the instructions.

Before starting any type of maintenance (controls or replacements), read the instructions below:

- never carry out maintenance with the machine switched on
- always remove the main power supply cable
- strictly follow all the instructions in the manual
- use original spare parts (see Spare Parts sheet provided).

7.1 TROUBLE SHOOTING

FAULT	PROBABLE CAUSE	
Machine is on, with no message on its display:	check to see if the back fan is working	
	Not working	a) emergency button activated
		b) general fuses in the power socket are faulty
	Working	a) fuse F3 on electronic control board is faulty
		b) connection wire between display and electronic circuit board loose
c) defective display		
cutter motor not working:	a) the closed protective shield is not making proper contact with the safety microswitch (fig. 41).	
	b) the F1 fuse on the electronic control board is faulty	
	c) motor wire not properly attached to the connector	
	d) defective electronic control board	
	e) motor cut-off WARNING: this may derive from inappropriate or heavy use of the key-cutting machine or a fault with the motor itself. DO NOT USE THE MACHINE and call Technical Silca Dept. to determining the cause of activation of the cut-off.	
X, Y and B axes motors are not working	None of the motors working:	a) fuse F2 on the electronic control board faulty
		b) the wiring between the transformer and electronic control board is loose or the connector is not seeded properly.
		c) defective electronic control board
	Only one motor is not working:	a) the connection wires between the motor and the electronic control board are loose or the connector is not seeded properly
		b) defective electronic control board
Protective shield is closed but the display reads "close shield"	a) the closed protective shield is not making proper contact with the microswitch (D3) (fig. 41)	
	b) the F4 fuse on the electronic control board is faulty	
Keyboard not working (partially or completely)	a) the keyboard connector is not properly connected to the interface board (fig.)	
	b) the wiring between the keyboard/display unit and electronic control board is not properly attached to the relative connectors	
	c) defective keyboard	
	d) defective electronic control board	
Electric contact not working (during calibrating or cutting)	a) wiring between the J14 connector on the electronic control board and cutter shaft is loose or disconnected	
	b) wiring inside the Y axis carriage is not seeded properly or disconnected	
	c) defective electronic control board	
	d) wear on the brushes (7.12, page 78)	

FAULT	PROBABLE CAUSE	
Optical reader not working	a) glass lens on the optical reader is dirty	
	b) wiring between optical reader and the electronic control board is not seeded properly	
	c) defective optical reader	
	d) defective electronic control board	
Key-cutting machine fails to communicate with computer	a) wiring between 9-pin serial port and electronic circuit board not seeded properly or disconnected	
	b) serial cable between key-cutting machine and computer is faulty	
	c) computer serial port is not functional	
	d) defective electronic control board	
The display shows the message: 'TEMPERATURE ALARM - turn the machine off'.	check that the fan on the back of the key-cutting machine is working:	
	Not working:	a) fan faulty
		b) electronic control board faulty
Working:	electronic control board faulty	
The display shows the message: 'I/O POWER ALARM - check fuse F4'.	a) fuse F4 on the electronic control board faulty.	
	b) short circuit on inlets or outlets. To find which inlet or outlet is causing the error message, disconnect the J4-5-7-8-12-14-15-20 connectors one at a time and check each time whether the alarm disappears.	
The display shows the message: 'DIGITAL OUTLET PROTECTION ALARM - turn the machine off'.	a) short circuit on the outlets. To find which outlet is causing the error message, disconnect the J4-5 connectors one at a time and check each time whether the alarm disappears.	
	b) internal fault on the electronic control board.	
The display shows the message: 'CUTTER MOTOR ALARM - check fuse F1'.	a) fuse F1 on the electronic control board faulty.	
	b) cutter microswitch on protective cover triggered or disconnected (D4) (fig. 41).	
	c) cutter motor wiring disconnected.	
	d) internal fault on the electronic control board.	

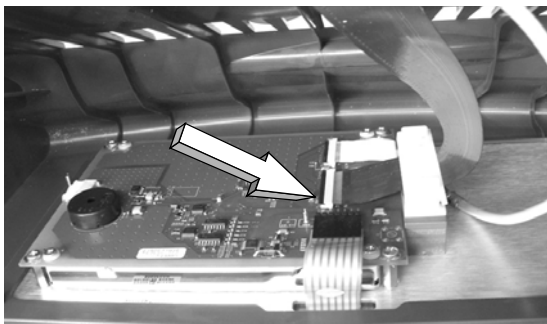


Fig. 40

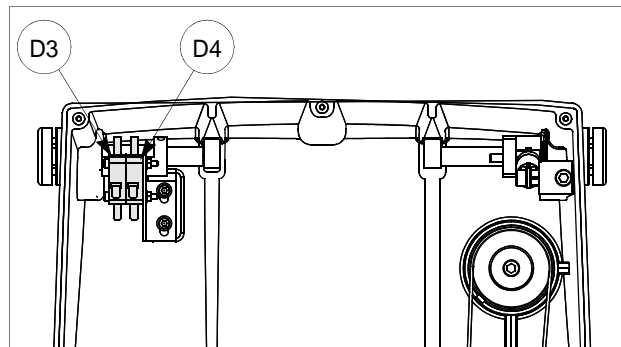


Fig. 41

7.2 MAINTENANCE OPERATIONS

- Cutter replacement
- Belt replacement and tension adjustment
- Fuse check and replacement
- Electronic circuit board replacement
- Keyboard/display replacement
- Access to back compartment
- Access to bottom compartment
- Sensor replacement
- Photocell replacement
- Brush replacement
- Battery replacement
- WIN-TRANSFER program for loading/updating the machine program

SAFETY MEASURES TO TAKE WHEN MANAGING ELECTRICAL / ELECTRONIC PARTS

ATTENTION: these operations must be carried out by trained qualified personnel.

Special care must always be taken in replacing electronic components. Observe closely the instructions below.

- Read the instructions carefully before proceeding with replacement.
- Work in an environment with a temperature of 10° to 40° C and relative humidity of approximately 60%.
- The workbench must be clean, free of foreign bodies and covered in shockproof material.
- Do not use compressed air.
- Do not work with wet or greasy hands.
- Ensure there are no static charges.

7.3 CUTTER REPLACEMENT

- 1) turn the machine off and unplug it.
- 2) remove the cutter protective shield (i) by loosening the screw (i2).
- 3) slide the cutter release rod (X) into the hole located on the left side of the machines cutter shaft chassis (fig. 42).
- 4) loosen the cutter locking nut (turning it clockwise) with the 19 mm socket wrench (X1) provided with the machine.

ATTENTION: the thread is left-handed (reversed).

- 5) replace the cutter, then tighten the nut (turning it counter-clockwise) and remove the rod from its hole.
- 6) place the cutters protective shield (i) back into position securing it with the screw (i2).

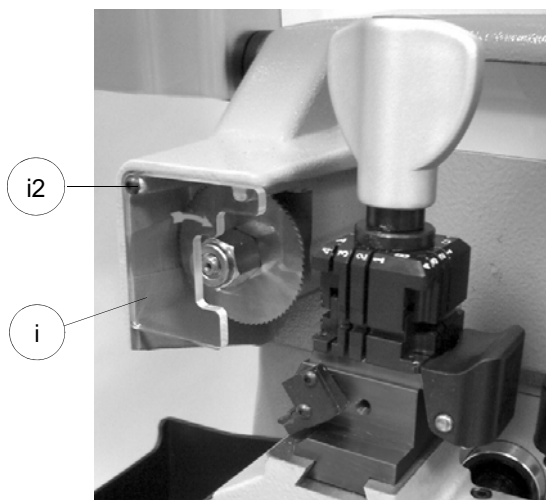
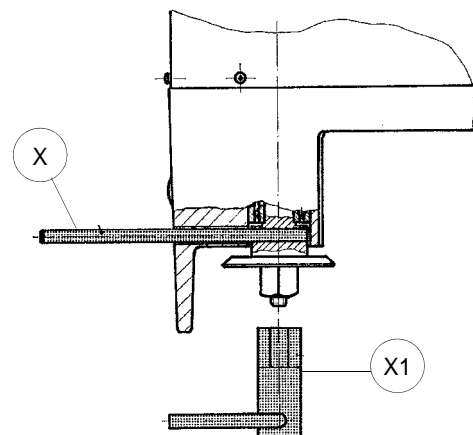


Fig. 42



ATTENTION: when replacing a worn cutter with a new one or with a re-sharpened cutter consult 5.8 "GAUGING".

7.4 BELT REPLACEMENT AND TENSION ADJUSTMENT

To replace the belt, proceed as follows:

- 1) turn the machine off and unplug it.
- 2) remove the back panel (chap.7.8, page 74).
- 3) remove the bottom panel (chap.7.9, page 74).
- 4) loosen the 4 screws (W) securing the motor (fig. 43).
- 5) remove the worn belt from the pulleys.
- 6) fit the new belt onto the pulleys, making sure that the direction of rotation is correct.
- 7) using the provided belt tension plate and the (W2) screw adjust the belt's tension by turning the (W2) screw.
- 8) tighten the 4 (W) screws back into place, securing the motor.
- 9) remount the back and bottom panel.

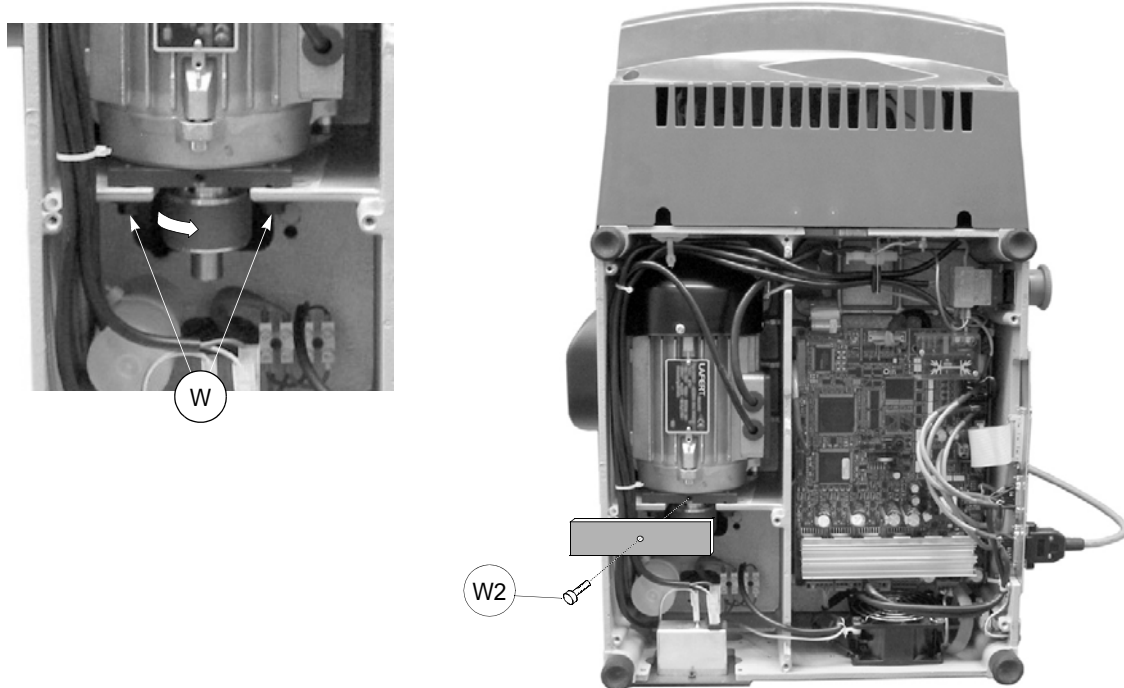


Fig. 43

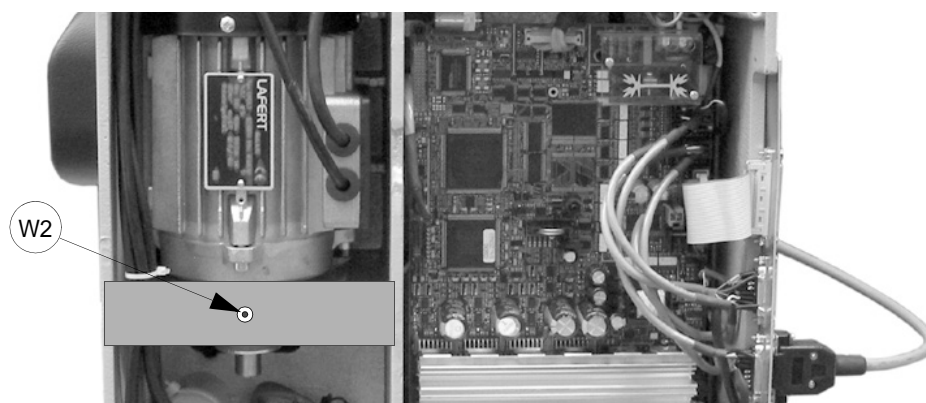


Fig. 44

To adjust belt tension proceed as follows:

- 1) turn the machine off and unplug it.
- 2) remove the bottom panel (chap.7.9, page 74).
- 3) loosen the 4 screws (W) securing the motor (fig. 43).
- 4) using the provided belt tension plate and the (W2) screw adjust the belt's tension by turning the (W2) screw.
- 5) tighten the 4 (W) screws back into place, securing the motor.
- 6) remount the bottom panel.

7.5 CHECKING AND/OR REPLACING FUSES

Fuses should be checked with a tester (ohmmeter, multimeter, etc.) as they may appear to be in good condition even when they are electrically faulty. Fuses must always be replaced with the same amperage and type (rapid or delayed), as indicated in this manual. There are 6 fuses in the UNOCODE 399 EVO.

- **2 fuses: 4 Amps rapid (230V)
5 Amps rapid (100V)**

located next to the power socket on the back of the machine, next to the main switch (fig. 45). These fuses protect the machine from power surges and/or spikes in the electricity supply.

To check and/or replace the fuses proceed as follows:

- 1) turn the machine off and unplug it from its power supply cable.
- 2) use a flat screwdriver to open the flap covering the socket, remove and check the fuses, replacing them if necessary.

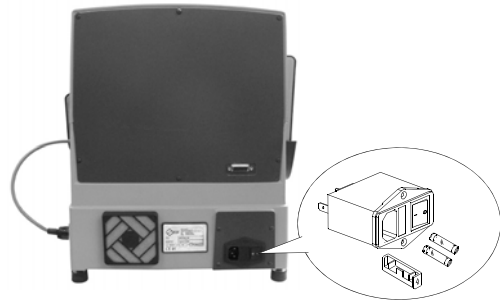


Fig. 45

- **4 fuses: F1, F2, F3 e F4**

F1: 10 Amps delayed

- protects the cutter motor and its electronic controls (230V a.c.)

F2: 6,3 Amps delayed

- protects the step motors and their electronic controls (+32V d.c.)

F3: 4 Amps delayed

- protects the logic control circuits on the microprocessor board (+5V d.c.)

F4: 2 Amps delayed

- protects the digital output circuits for the low voltage controls and the sensor inlets (+24V d.c.)

Situated on the electronic circuit board inside the base of the machine (fig. 46), protecting the board from short circuits.

To check and/or replace the fuses proceed as follows:

- 1) turn the machine off and unplug it from its power supply cable.
- 2) remove the bottom panel (chap.7.9, page 74).
- 3) check and, if necessary, replace the fuses in the way described below:

to remove the fuse:

- press the fuse cap with your fingers and turn it counter clockwise.

To fit the new fuse:

- carefully position the fuse back into place, then gently press the fuse cap downwards turning it clockwise.

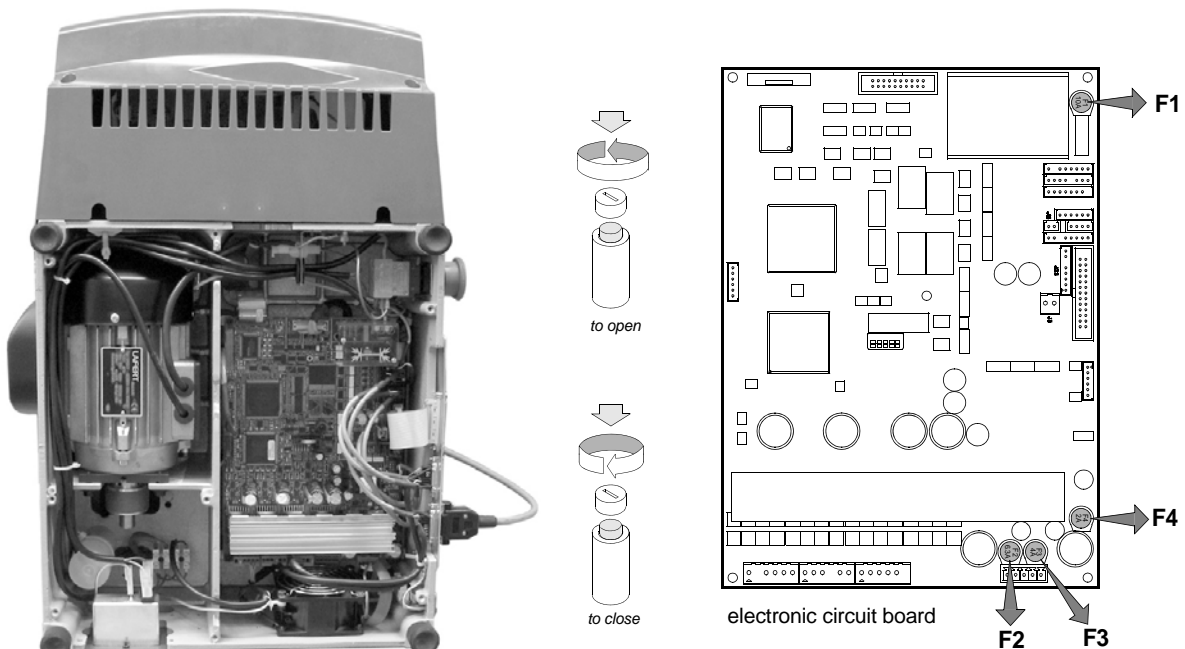


Fig. 46

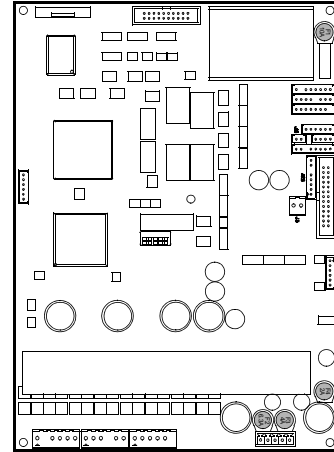
7.6 ELECTRONIC CIRCUIT BOARD REPLACEMENT

Proceed as follows:

- 1) turn the machine off and unplug it from its power supply cable.
- 2) remove the bottom panel (ch.7.9, page 74).
- 3) disconnect all cable connectors from the electronic circuit board (fig. 47).



Fig. 47



electronic circuit board

- 4) take the electronic circuit board off by unscrewing the (Y1) nuts off (fig. 48).
- 5) mount the new electronic circuit board and re-connect all cables (all cable connections are polarised therefore cannot be connected incorrectly).
- 6) re-fit the bottom panel and re-position the machine on its workbench.
- 7) turn the machine on and launch the WIN-TRANSFER program (chap.7.14, page 79).

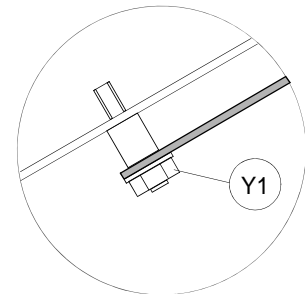


Fig. 48

7.7 KEYBOARD/DISPLAY REPLACEMENT

- 1) turn the machine off and unplug it from its power supply cable.
- 2) remove the display's support, by unscrewing the 2 (B1) fixing screws (fig. 49 and fig. 50).
- 3) detach the flat cable and ground wire from the keyboard (fig. 51).
- 4) unscrew the keyboard's fixing nuts and remove the keyboard from its support.
- 5) fit the new keyboard/display, repeating the operations described above, backwards.

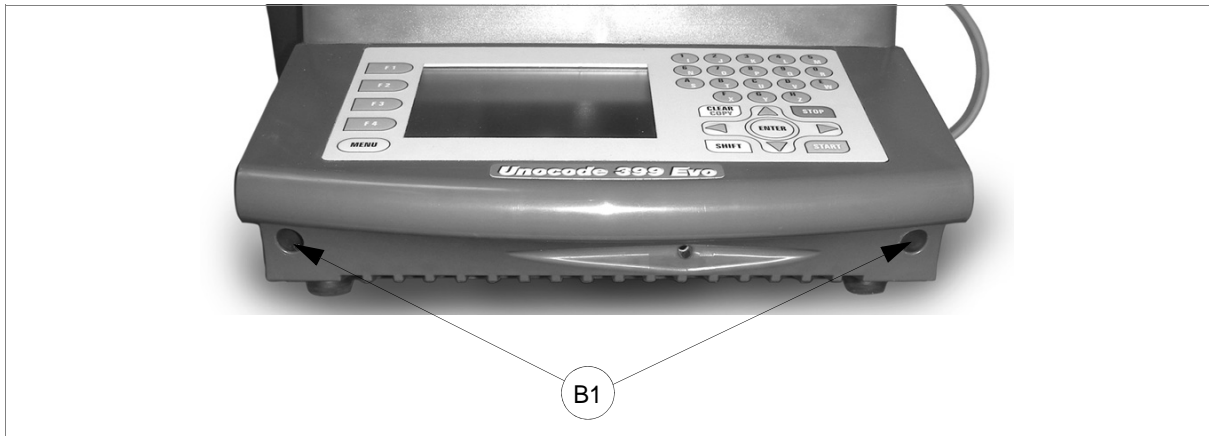


Fig. 49



Fig. 50

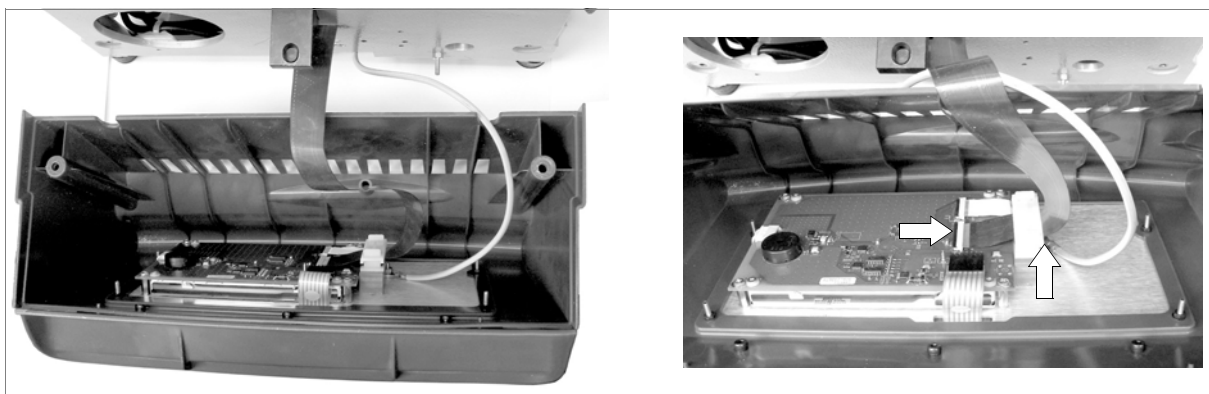


Fig. 51

7.8 ACCESS TO BACK COMPARTMENT

To gain access to the back compartment, proceed as follows:

- 1) turn the machine off and unplug it from its power supply cable.
- 2) remove the vacuum system's connector (U2) (fig. 52).
- 3) unscrew the 6 (M1) screws that secure the back panel (fig. 52) thus removing it.

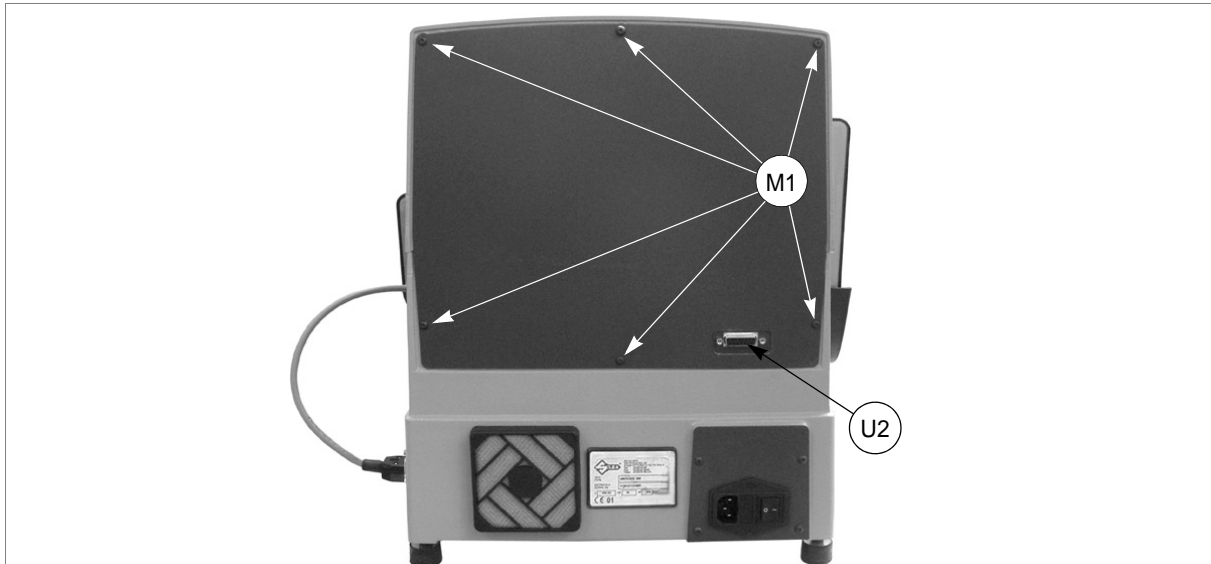


Fig. 52

7.9 ACCESS TO BOTTOM COMPARTMENT

To gain access to the bottom compartment, proceed as follows:

- 1) turn the machine off and unplug it from its power supply cable.
- 2) remove the vacuum system's connector (U2) (fig. 52).
- 3) turn the machine on its back side.
- 4) remove the machine's bottom panel by unscrewing the 8 (L1) screws.



Fig. 53

7.10 SENSOR REPLACEMENT

X AXIS SENSOR REPLACEMENT

- 1) turn the machine off and unplug it from its power supply cable.
- 2) remove the bottom panel (chap.7.9 "Access to bottom compartment").
- 3) disconnect the X axis sensor's connector from the electronic circuit board (fig. 54).
- 4) loosen the (L3) nut. Unscrew the sensor from the plate and remove (fig. 55).
- 5) remove the front cover on the (X axis) lower carriage by unscrewing the 3 (B4) screws (fig. 56).
- 6) fit the new sensor in position, tightening it until it almost touches the (L2) screw (fig. 55) thus securing it with the (L3) nut.
- 7) connect the sensor's connector to the electronic circuit board.
- 8) remount the bottom panel and front cover.

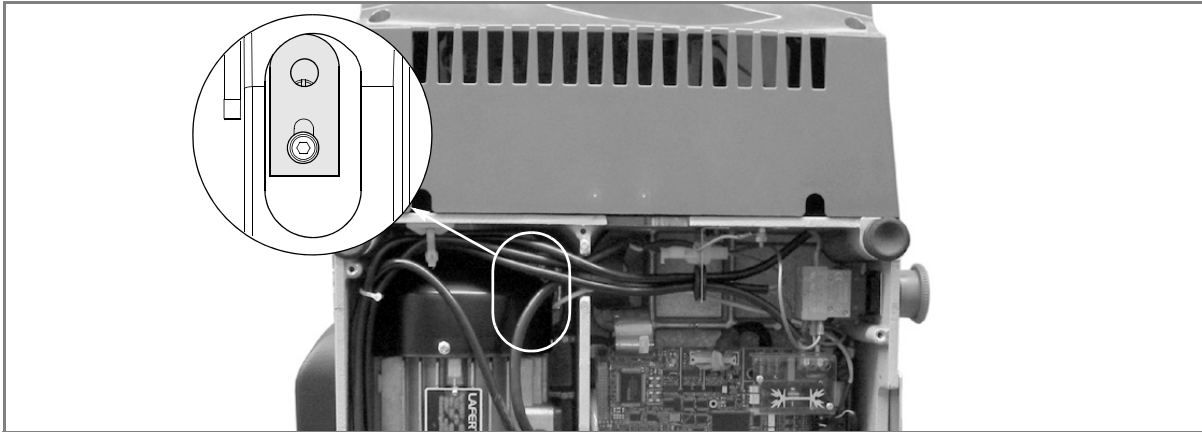


Fig. 54

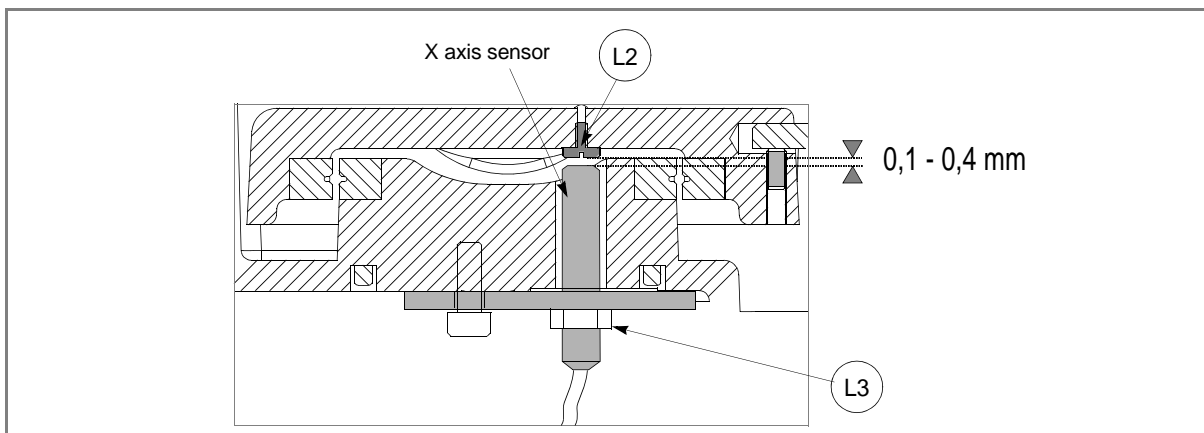


Fig. 55

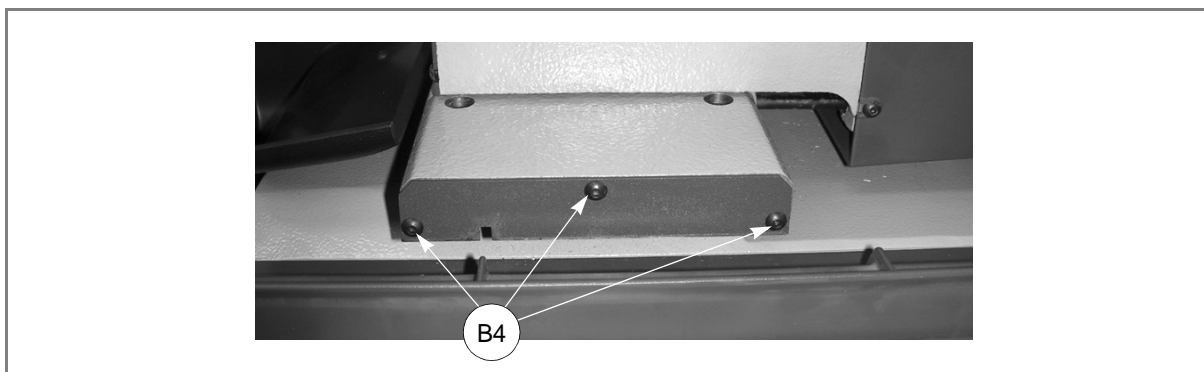


Fig. 56

Y AXIS SENSOR REPLACEMENT

- 1) turn the machine off and unplug it from its power supply cable.
- 2) raise the protective shield.
- 3) disconnect the (J1) Y axis cable from the carriage (fig. 57).
- 4) remove the Y axis carriage cover by unscrewing the 3 (B5) locking screws and pull the cover in the direction shown in fig. 57.
- 5) disconnect the (M3) sensor's connector (fig. 58).
- 6) slightly loosen the (M2) grub screw with the provided allen key.
- 7) remove the faulty sensor and replace it with a new one. Screw it in until it almost touches the underlying rod (fig. 59). Tighten the (M2) grub screw to lock the sensor into place.

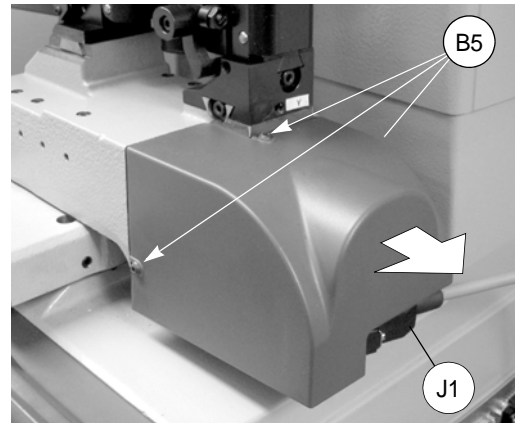


Fig. 57

- 8) connect the (M3) sensor's connector.
- 9) replace the Y axis carriage cover.
- 10) connect the (J1) Y axis connecting wire to the carriage.

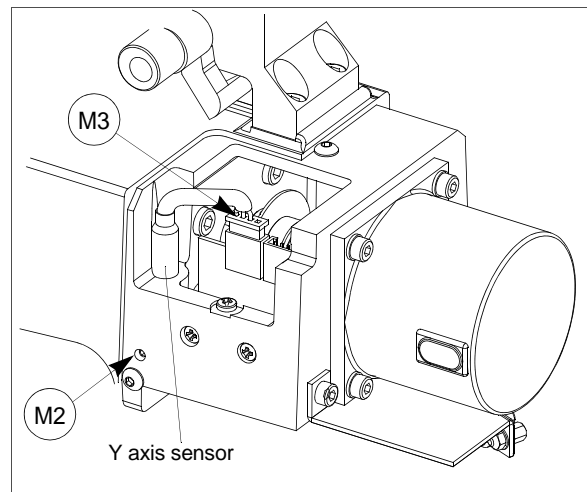


Fig. 58

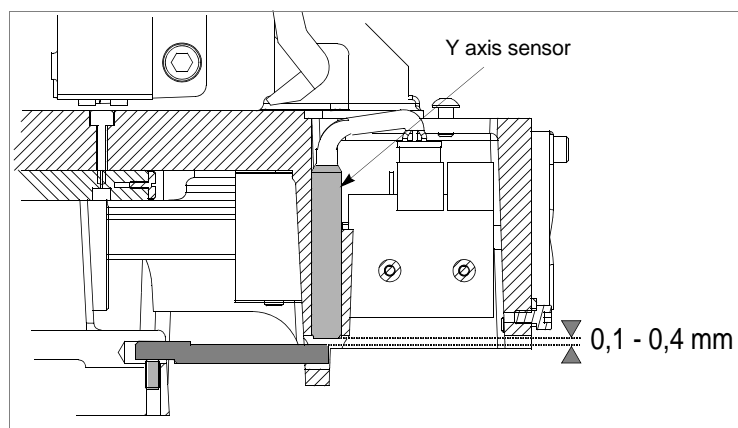


Fig. 59

7.11 PHOTOCELL REPLACEMENT

REPLACING THE X AXIS PHOTOCELL

- 1) turn the machine off and unplug it from its power supply cable.
- 2) remove the back panel (chap.7.8 "Access to back compartment").
- 3) unscrew the 2 (G) screws that secure the photocell card and remove.
- 4) disconnect the (G5) photocell cable (fig. 60).
- 5) connect the photocell cable to the new photocell card.
- 6) replace the photocell in position securing it with the (G) screws.
- 7) remount the back panel.
- 8) plug the machine back in and turn it on.
- 9) proceed with machine settings (chap.5.9.8 "MACHINE ZERO POINTS", page 50).

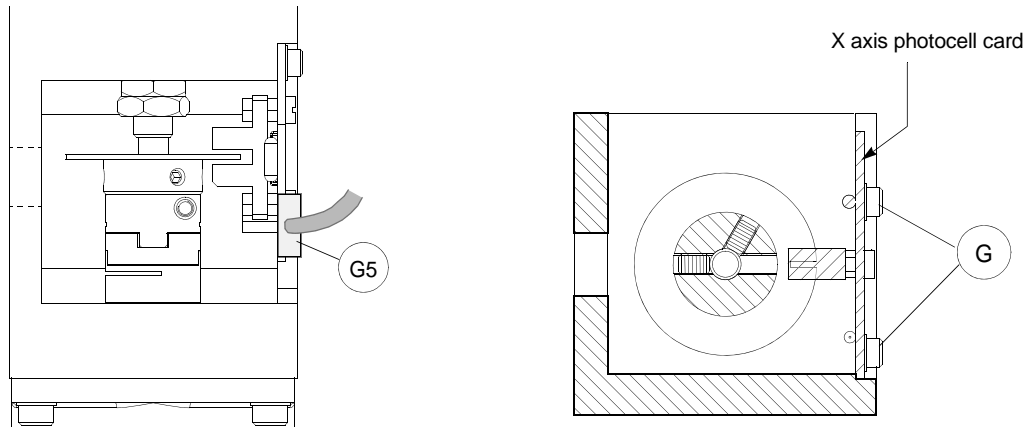


Fig. 60

REPLACING THE Y AXIS PHOTOCELL

- 1) turn the machine off and unplug it from its power supply cable.
- 2) disconnect the (J1) Y axis cable from the carriage (fig. 61).
- 3) remove the Y axis carriage cover by unscrewing the 3 (B5) locking screws and pull the cover in the direction shown in fig. 61.
- 4) disconnect the (J2) photocell cable and (J) sensor cable (fig. 61).
- 5) unscrew the 2 (K) screws that hold the photocell card and remove it from the carriage.
- 6) place the new photocell card in the carriage and tighten the 2 (K) supporting screws.
- 7) reconnect both the photocell and sensor cables.
- 8) remount the Y axis protective cover.
- 9) connect the (J1) Y axis cable back on the carriage.
- 10) plug the machine back in and turn it on.
- 11) proceed with machine settings (chap.5.9.8 "MACHINE ZERO POINTS", page 50).

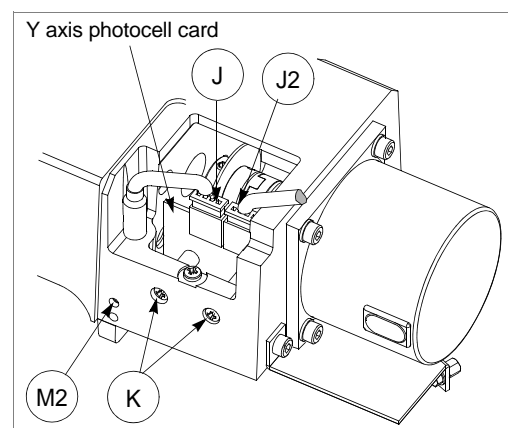
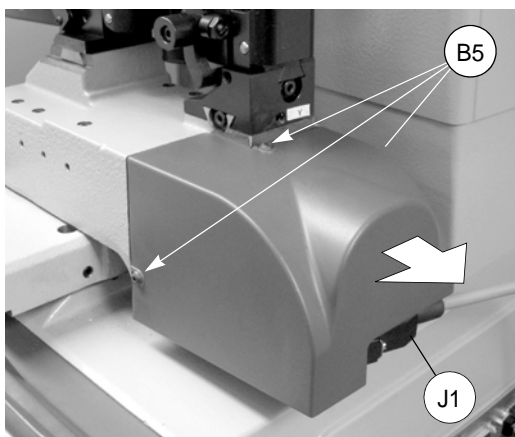


Fig. 61

7.12 BRUSH REPLACEMENT

- 1) open the rear compartment (ch.7.8, page 74).
- 2) unscrew the two brush caps (M4) (fig. 62), remove and fit two new brushes.
- 3) replace the two caps (M4).
- 4) close the rear compartment.
- 5) carry out Test 7 to check proper operation (ch.5.9, page 48).

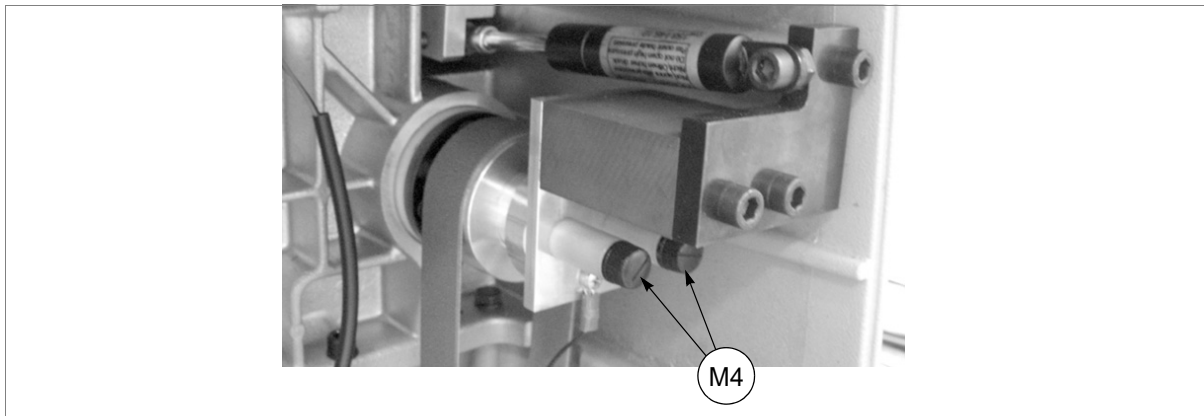


Fig. 62

7.13 BATTERY REPLACEMENT

Replacing the battery is a simple operation but must be carried out with care.

- 1) Disconnect the power lead from the key-cutting machine.
- 2) Gain access to the bottom compartment.
- 3) Use pliers with insulated tips to grip the battery and pull it out, taking care to push towards the pressure tab to remove from its shaped housing.
- 4) Use the pliers with insulated tips to introduce the new battery, inclining it and pushing against the tab to help it enter the shaped housing.
- 5) Close up the machine and connect to the mains.
- 6) Reconfigure the date and time on the machine (chap.5.10, page 56).

ATTENTION: RISK OF EXPLOSION IF BATTERY IS REPLACED BY AN INCORRECT TYPE.

DISPOSE OF USED BATTERIES ACCORDING TO THE INSTRUCTIONS (chap.8 "DISPOSING OF MACHINE", page 80).

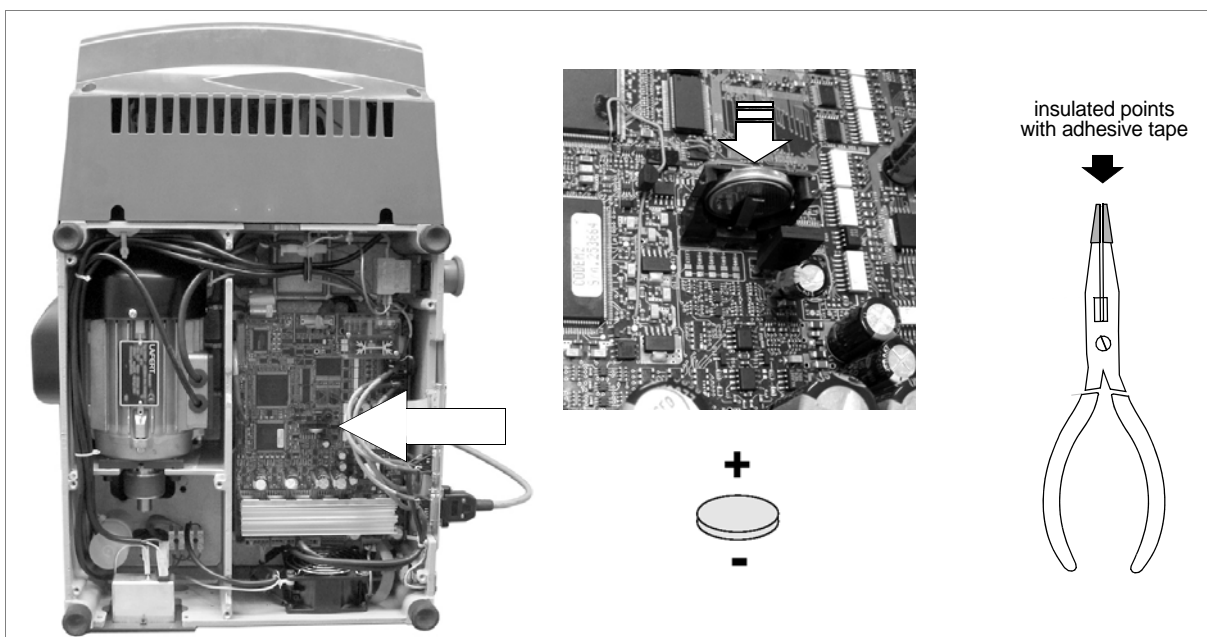


Fig. 63

7.14 WIN-TRANSFER PROGRAM FOR LOADING/UPDATING THE INTERNAL MACHINE PROGRAM

The machine is supplied with an internal program already loaded and tested in our workshops. The user therefore does not need to carry out any operations.

Only in the situations described below can the WIN-TRANSFER program be used to re-start the machine. **The following is a list of situations where the use of the WIN-TRANSFER program is required.**

- **Replacement of the electronic board (see chap. 7.6, page 72) or loss of the internal machine program.**

- 1) replace the board with a new one, if necessary.
- 2) install on your personal computer the latest version received of the WinTransfer program.
- 3) read the serial number on the data plate on the back of the machine (ch.5.10, page 56) and enter on the machine.
- 4) gauge the machine according to the instructions in the manual, as follows:
 - gauge as explained in chapter 5.9.8 "MACHINE ZERO POINTS" and chap.5.8.1 "Calibrate JAWS" in the user's manual.
 - first gauge the V100 clamp (chap. 5.8.1, page 43) then the R100 clamp.
 - continue with the gauging of remaining jaws used.

At this point the machine is set up and ready for operation.

- **SILCA update for the program or machine data**

- 1) Install the WinTransfer Program update on your personal computer, following the instructions in the program.

8 DISPOSING OF MACHINE

To dispose the machine, it must be rendered unusable by carrying out the operations listed below:

- deactivation of the electricity supply;
- separation of the plastic and metal parts;
- remove the lithium battery from the electronic board;

ATTENTION: the lithium battery must be disposed in the special containers.

When these operations have been carried out, the machine can be disposed of according to the current regulations in the country of use.

WASTE DISPOSAL

CEE standards state special regulations for waste disposal (**).

Machine

The UNOCODE 399 EVO, is made up of recyclable parts. Recycling is ecologically recommended.

Packing

The packing in which the machine is transported is made of cardboard and wood therefore can be re-used if intact or if dismantled used as combustible materials.

Warning! Take great care when dismantling the packing as it contains nails, which could cause injuries. We recommend to bend the nails downwards into the wood with a hammer or to completely remove the nails disposing them in authorized metal recycling centres.

The packing is considered solid urban waste and must not be thrown into the environment but placed in special cardboard collection bins.

Waste deriving from key cutting

The waste deriving from key cutting is classified special waste, but is still classified as solid urban waste, as metal wool. Such waste must be disposed of in special collection centres according to the classification assigned to them by the current EEC law. The circumstances which transform metal residue from solid urban waste into contaminated or toxic noxious waste are listed in the appendices to the current European Union regulations regarding disposal of such waste.



INFORMATION FOR USERS

as per art. 10 of Directive 2002/96/CE of 27/01/2003 regarding waste from electric and electronic appliances (RAEE),

- The symbol illustrated above, also found on the machine, indicates that it has been placed on the market and must be included in separate rubbish collection when the user wishes to dispose of it (including all components, sub-assemblies and consumables that are integrated in the product).
- For information about the collection system for such appliances please contact SILCA S.p.A. or another subject registered in the various National Rolls for other countries in the European Union. Household waste (or of similar origin) can be included in the separate collection system for urban waste.
- On purchasing a new appliance of equivalent type, the old one can be consigned to the dealer. The dealer will then contact whoever is responsible for collecting the appliance.
- Suitable separate collection of the unused appliance and its dispatch for treatment, recovery and environmentally compatible disposal, makes it possible to avoid potential negative effects on the environment and human health, and aids recycling and the recovery of the materials used.
- Unauthorised disposal of the product by users involves the application of the sanctions provided for in received Directives 91/156/CE and 91/689/CE.

(**) *Waste is any substance or object deriving from human activity or natural cycles, disposed off or to be disposed off.*

9 ASSISTANCE

Silca provides full service to purchasers of the UNOCODE 399 EVO key-cutting machine. To ensure complete safety to the operator and machine, any job not specified in this manual should only be carried out by the manufacturer or recommended Silca Service Centres.

On the back cover of this manual is a list of the manufacturer's addresses; listed below are the addresses of specialized service centres.

9.1 HOW TO REQUEST SERVICE

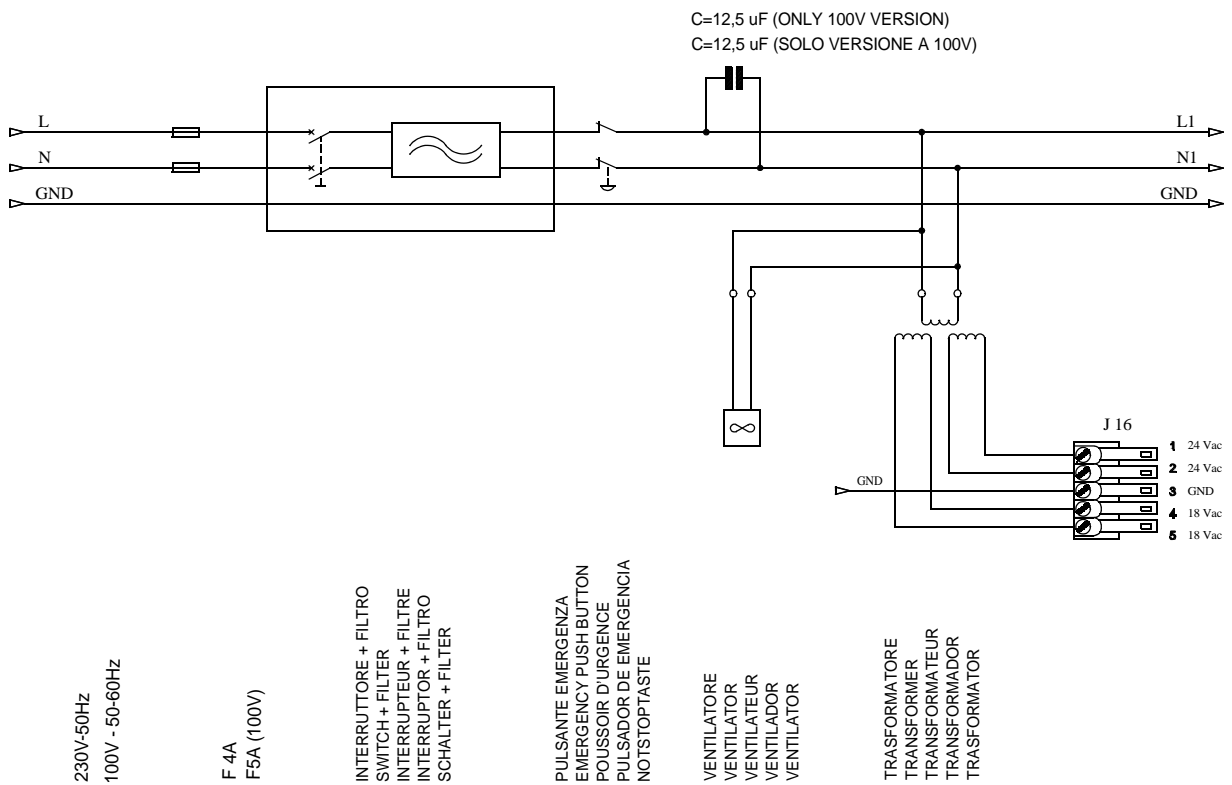
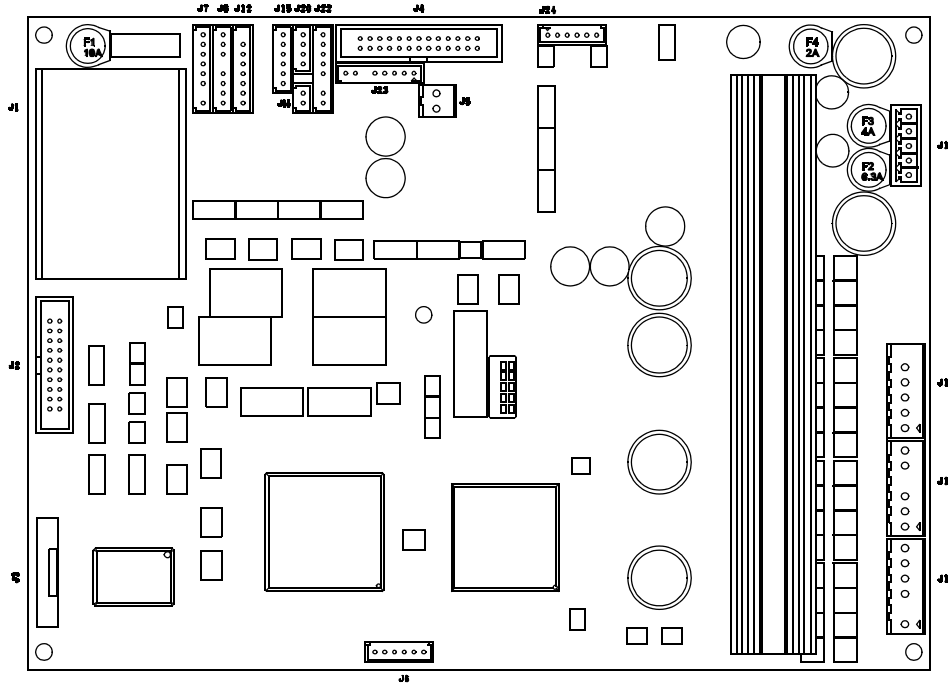
The guarantee attached to the 399 UNOCODE EVO ensures free repairs or replacements of faulty parts within 24 months of the date of purchase. All other service calls must be arranged by the customer with Silca or specialized Silca service centres.

Appendix 1 - ELECTRICAL DIAGRAMS

The following pages contain the electrical diagrams for the UNOCODE 399 EVO key-cutting machine described in this manual.

UNOCODE 399 EVO

ELECTRICAL DIAGRAMS



230V-50Hz
100V - 50-60Hz

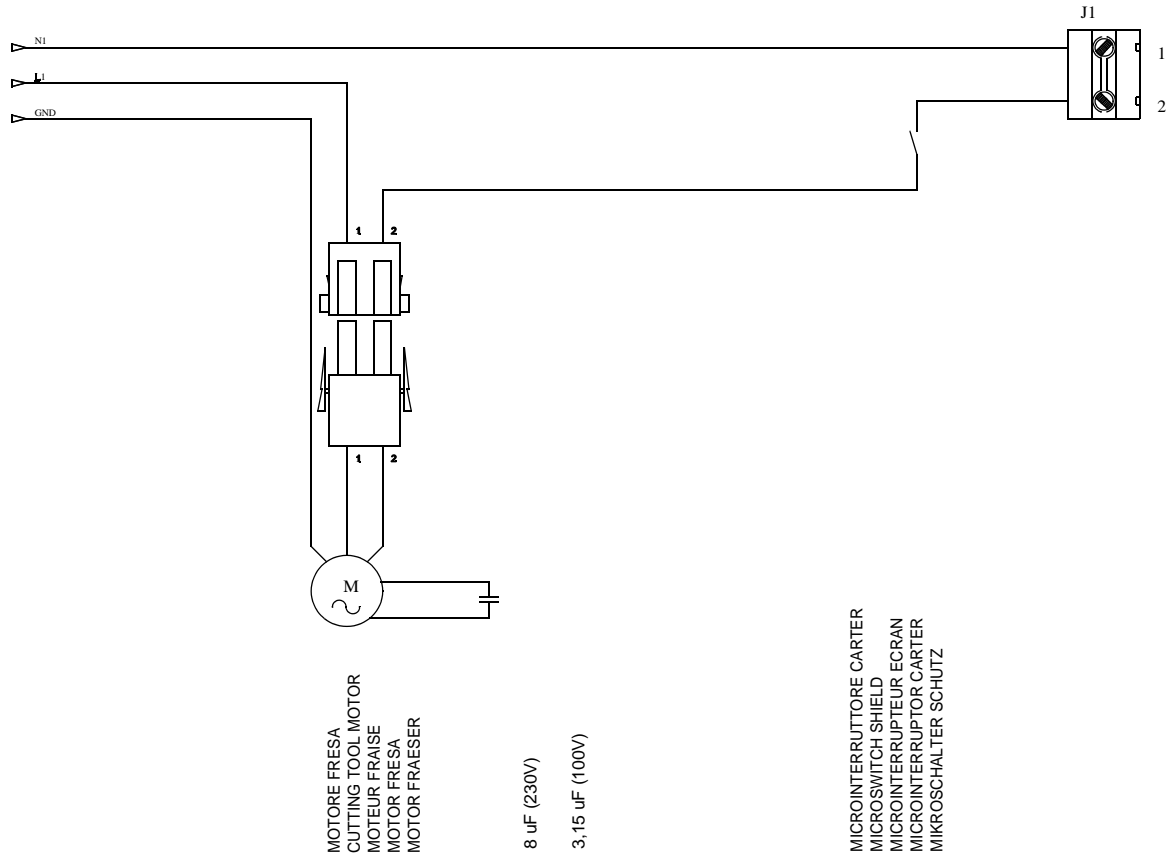
F 4A
F5A (100V)

INTERRUTTORE + FILTRO
SWITCH + FILTER
INTERRUPTEUR + FILTRE
INTERRUPTOR + FILTRO
SCHALTER + FILTER

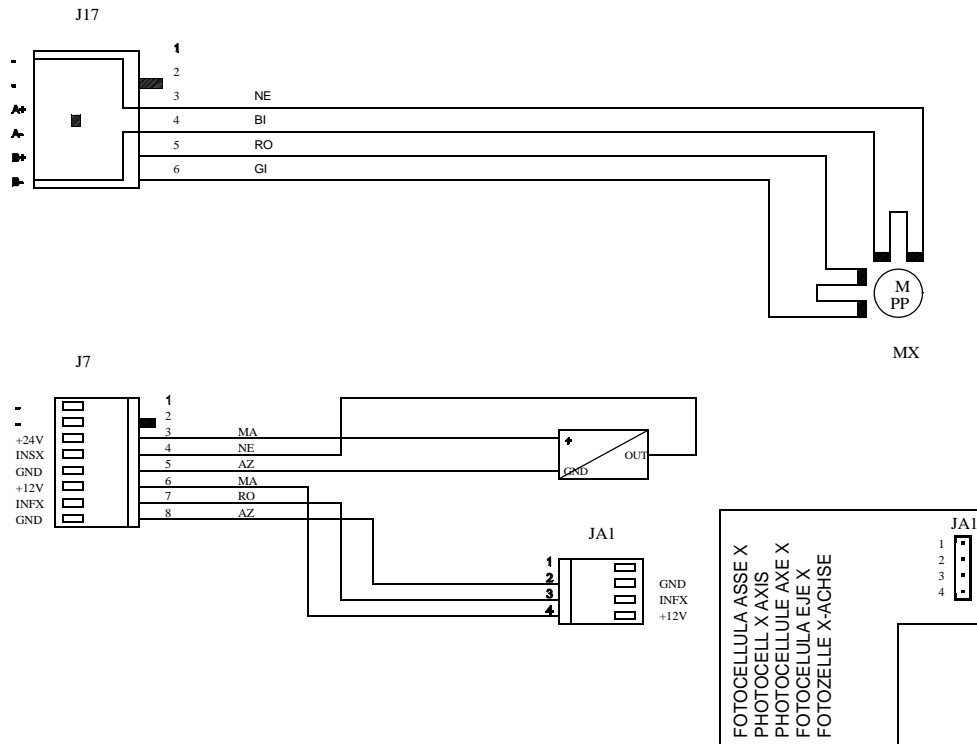
PULSANTE EMERGENZA
EMERGENCY PUSH BUTTON
POUSSOIR D'URGENCE
PULSADOR DE EMERGENCIA
NOTSTOPTASTE

VENTILATORE
VENTILATOR
VENTILATEUR
VENTILADOR
VENTILATOR

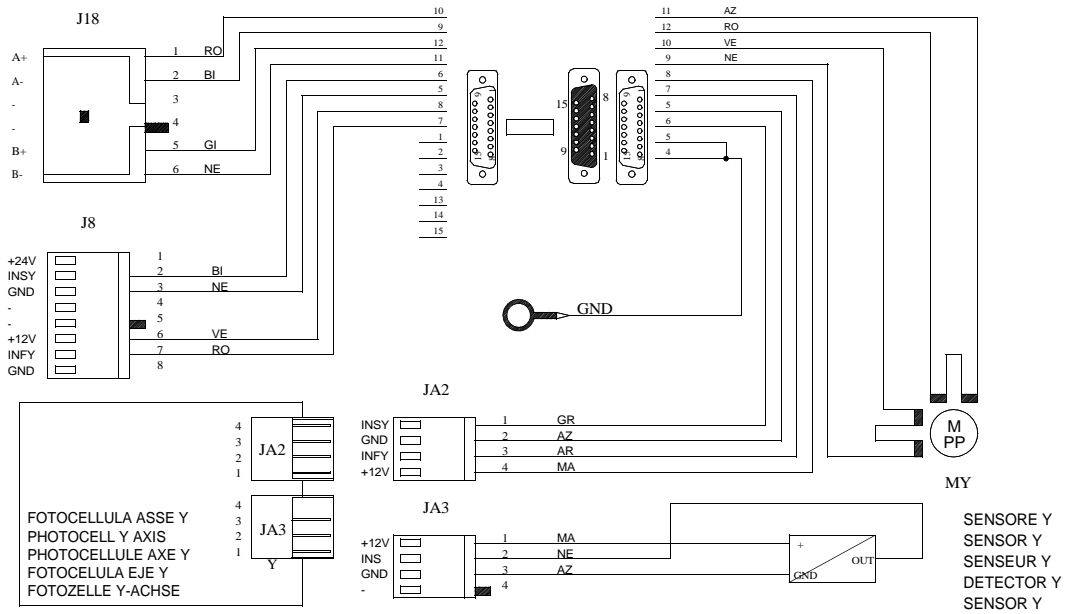
TRASFORMATORE
TRANSFORMER
TRANSFORMATEUR
TRANSFORMADOR
TRANSFORMATOR



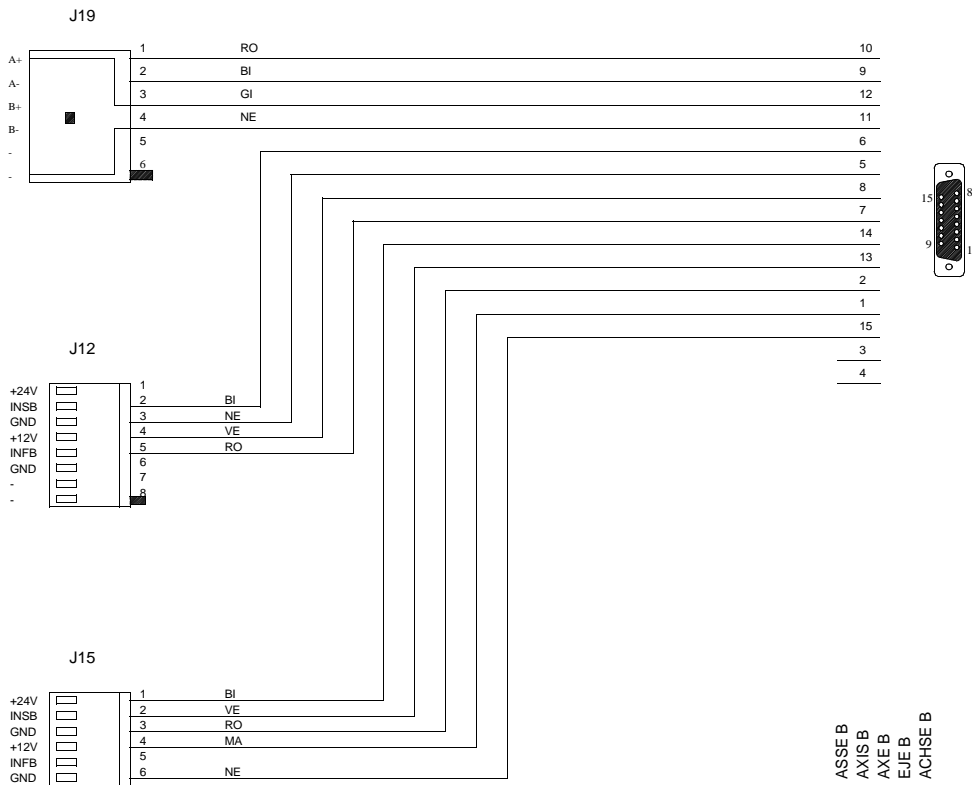
RO	ROSSO RED ROUGE ROJO ROT
BI	BIANCO WHITE BLANC BLANCO WEISS
AR	ARANCIO ORANGE ORANGE ANARANJADO ORANGE
NE	NERO BLACK NOIR NEGRO SCHWARZ
MA	MARRONE BROWN BRUN MARRON BRAUN
AZ	AZZURRO BLUE AZUR AZUL BLAU

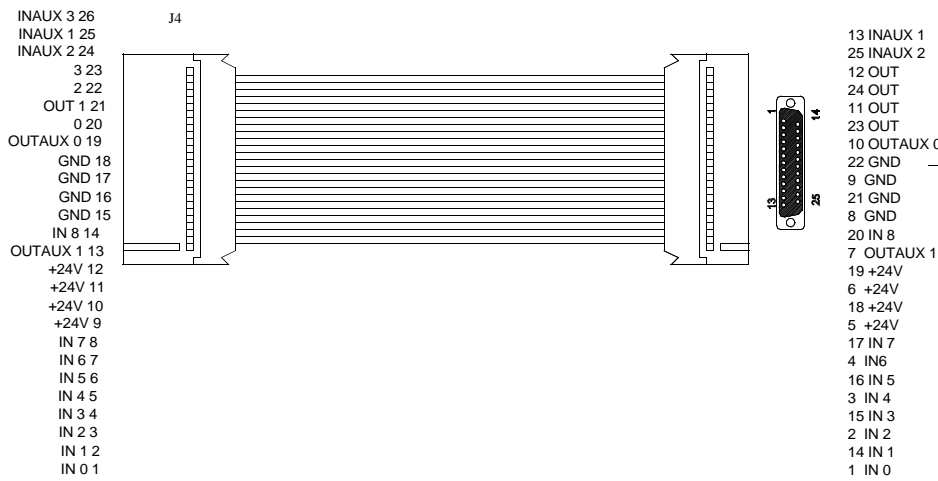
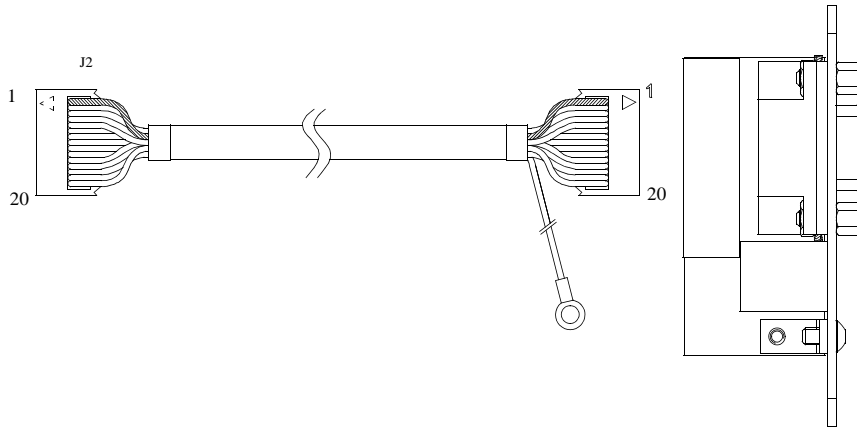


RO	ROSSO RED ROUGE ROJO ROT
GI	GIALLO YELLOW JAUNE AMARILLO GLEB
AR	ARANCIO ORANGE ORANGE ANARANJADO ORANGE
NE	NERO BLACK NOIR NEGRO SCHWARZ
MA	MARRONE BROWN BRUN MARRON BRAUN
AZ	AZZURRO BLUE AZUR AZUL BLAU
BI	BIANCO WHITE BLANC BLANCO WEISS
RO	GRIGIO GREY GRIS GRIS GRAU
VE	VERDE GREEN VERT VERDE GRUN

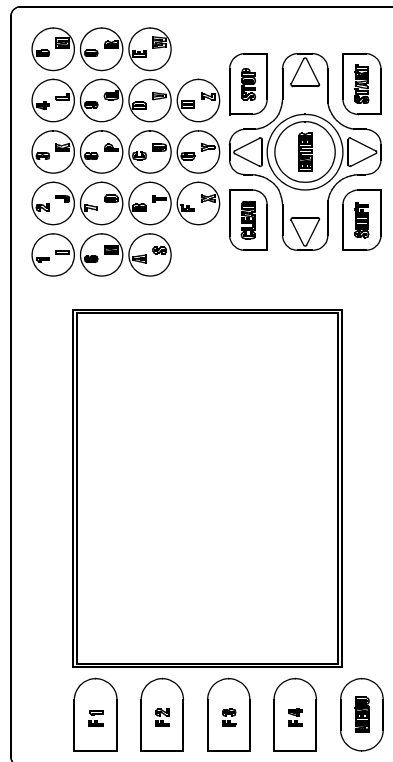
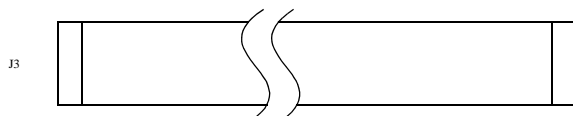


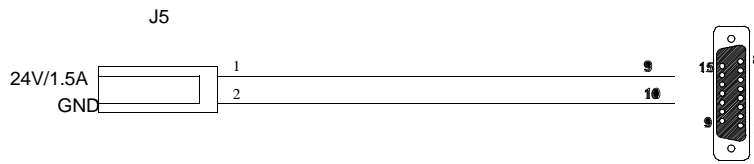
RO	ROSSO RED ROUGE ROJO ROT
BI	BIANCO WHITE BLANC BLANCO WEISS
AR	ARANCIO ORANGE ORANGE ANARANJADO ORANGE
NE	NERO BLACK NOIR NEGRO SCHWARZ
MA	MARRONE BROWN BRUN MARRON BRAUN
AZ	AZZURRO BLUE AZUR AZUL BLAU
AZ	AZZURRO BLUE AZUR AZUL BLAU
VE	VERDE GREEN VERT VERDE GRUN
GI	GIALLO YELLOW JAUNE AMARILLO GLEB





ALIMENTATORE AUTOMATICO
 AUTOMATIC FEEDER
 ALIMENTATEUR AUTOMATIQUE
 ALIMENTADOR AUTOMATICO
 AUTOMATISCHE ZUFUHRER

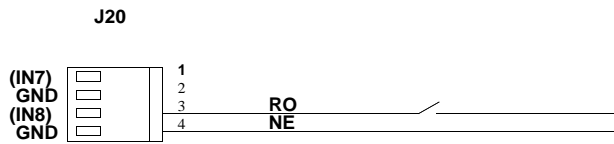




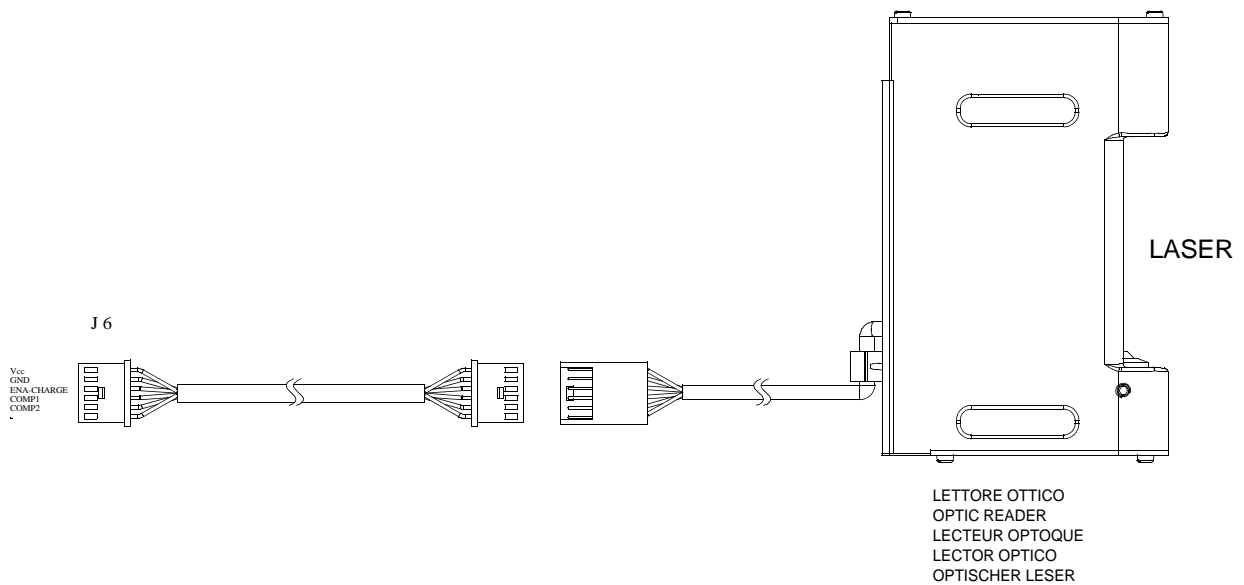
ELETTROVALVOLA ASPIRAZIONE
 VACUUM SOLENOID VALVE
 ELECTROVANNE ASPIRATION
 ELECTROVALVULA ASPIRADOR
 ELEKTROVENTIL SPANEABSAUGANLAGE

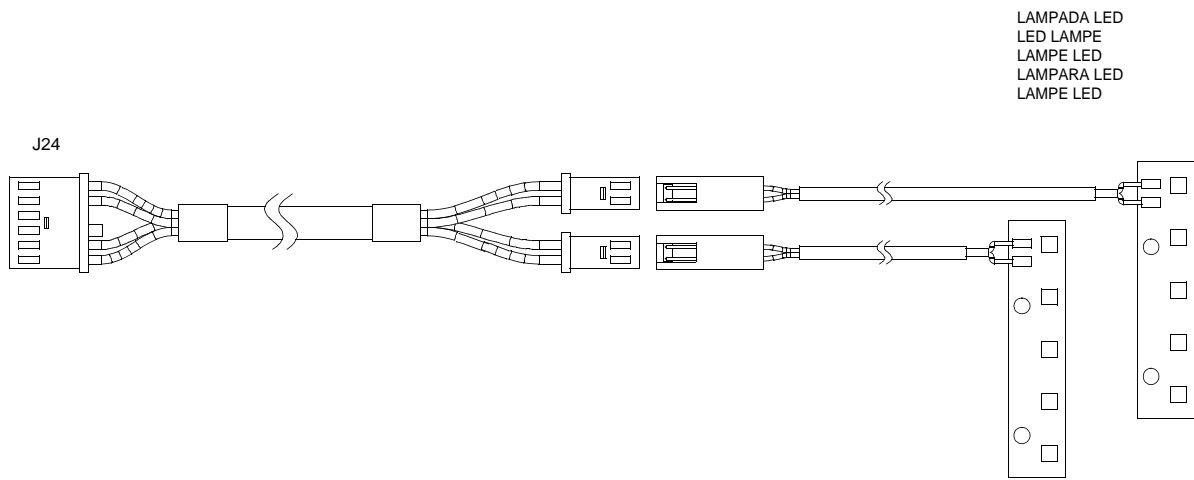


CONTATTO ELETTRICO CHIAVE
 ELECTRIC CONTACT
 CONTACT ELECTRIQUE
 CONTACTO ELECTRICO
 ELEKTRISCH KONTAKT



MICROINTERRUTTORE CARTER
 MICROSWITCH SHIELD
 MICRO-INTERRUPTEUR ECRAN
 MICROINTERRUPTOR CARTER
 MIKROSCHALTER SCHUTZ







VITTORIO VENETO 24/03/2011

CE DECLARATION OF MACHINE COMPLIANCE

**SILCA S.p.A. - VIA PODGORA 20 (Z.I.)
31029 VITTORIO VENETO (TV) - (ITALY)
TEL. 0438 9136 - FAX. 0438 913800**

Declares under its own responsibility that the **Key-cutting machine** model

UNOCODE 399 EVO

complies with the requirements of the following European Directives:

European Union **DIRECTIVE 2006/42/CE** (Machines)
and with the EN 12100 – 1 / EN 12100 – 2 Standards

European Union **DIRECTIVE 2004/108/CE** (Electromagnetic Compatibility)
and with the EN 55022 / EN 55024
EN 61000 – 3 – 2 / EN 61000 – 3 – 3 / EN 62233 : 2008 Standards

European Union **DIRECTIVE 2006/95/CE** (Low Voltage)
and with the EN 60950 – 1 / EN 60825 – 1 Standards

| 08 |

Claudio Tomasella of the Silca S.p.A. Research & Development Division is authorized to create a Technical File.

General Manager Basic Production Center

Stefano Setti

SILCA S.p.A.
Via Podgora, 20 (Z.I.)
31029 Vittorio Veneto (TV) Italy

A Member of the Kaba Group

Tel. +39 0438 9136 Fax +39 0438 913800 www.silca.it info@silca.it
P. IVA C.F. e Reg. Impr. IT03286730266 REA TV 258111
Cap. Soc. € 10.000.000 i.v. Export TV 038851

Società soggetta a direzione e coordinamento di Kaba Holding AG, con sede in Rümlang (Svizzera),
Hofwisenstrasse 24, ai sensi e per gli effetti degli articoli 2497 - 2497sexies del Codice Civile.





**SERVICE CENTERS - CENTRI DI ASSISTENZA - KUNDENDIENSTZENTREN - CENTRES D'ASSISTANCE
CENTROS DE ASISTENCIA - CENTROS DE ASSISTÊNCIA - BIJSTANDSCENTRA**

COUNTRY	COMPANY	ADDRESS	CITY	AREA CODE	PHONE	FAX e-mail
Algeria	Sarl Maghreb Clés	Coopérative Ettadhamoune Local 21/A	Badjarah / Alger	16209	+213-21-264934	+213-21-264888 asmaghreb_cle@yahoo.fr
Argentina	Distribuidora Frappampino S.r.l.	La Rioja, 483	Cordoba	5000	+54-351-4216368	+54-351-4229003 frappampino@arnet.com.ar
Australia	Locksmiths' Supply Co. Pty Ltd.	140/158 Dryburgh St.	North Melbourne	VIC 3051	+61-39-3297222	+61-39-3281731 lsc@lsc.com.au
Austria	Erwe Gmbh	Feldgasse, 16	Feldkirchen	A-9560	+43-42762816	+43-42765054 firma@erwe.at
Belgium	Duitman Bvba	Zinkstraat 13	Halle	1500	+32-2-3831620	+32-2-3831622 info@duitman.be
Brazil	Kaba Do Brasil Ltda.	Rua Guilherme Asbahr Neto 510	São Paulo	04646- 001	+55-11-5545-4510	+55-11-5545-4515 kaba@kabadobrasil.com.br
Bulgaria	Intesa S.r.l.	1, Kukush	Sofia	01309	+359-2-8211425	+359-2-8211347 info@intesa.bg
Burkina Faso	Diallo Mamoudou	Av.Houari Boumedienne Porte N. 1651	01BP / 2957 Ouagadougou 01		+226-710448	+226-710002 dialloebauchedecles@yahoo.fr
China	Silca China	Xinhua Industrial Zone	Guanghai County, Taishan, Canton		+86-750-5325698	+86-750-5315655 alan@tswahyat.com
Colombia	Flexon Llaves S.A.	Av.Carrera 70 No.99 - 55 Entrada 1	Bogotá		+571-2538300	+571-5331842
Croatia	Ferrotechna d.o.o.	Japodska, 66c	Pula	52100	+385-52-503-529 +385-52-502-609	+385-52-503-529 ferrotechna@pu.t-com.hr
Cyprus	G.H. Yacoubian Ltd.	74/B, Regaena Street	Nicosia		+357-22-663525	+357-22-669009 ghycy@spidernet.com.cy
Czech Republic	H&B Plus. s.r.o.	Zatecká, 8	Plzen	30148	+420-377-225903	+420-377-225904 plzen@klice-hb.cz
Denmark	Agenturcentret A.S	Brydehusvej 20	Ballerup	2750	+45-70111211	+45-70111221 agentur@agenturcentret.dk
Egypt	Gam Transworld	23 Omer Ibn El-Khatar Street	Heliopolis El Cairo		+20-2-22404705 +20-2-26441401	+20-2-22404705 gam@intouch.com
Finland	Hardware Group Finland Oy. (Hgf Ltd)	Luostarinportti 5	Kirkkonummi	02400	+358-9-2219490	+358-9-2962186 asiakaspalvelu@hgf.fi
France	SILCA S.A.S.	12, Rue de Rouen B.P.37	Z.I. Limay Porcheville	78440	+33-1-30983500	+33-1-30983501 info@silca.fr
Germany	SILCA GmbH	Siemensstrasse, 33	Velbert	42551	+49-2051-2710	+49-2051-271172 info@silca.de
Greece	Chrisikos K. Ioannhs	7 Pipsou St.	Thessalonik	TK 54627	+30-2310-510336	+30-2310-521651 info@keys.gr
Greece	F. Sotiropoulos & Son O.E.	Patission Str., 110	Athens	11257	+30-210-8234009	+30-210-8238480 roulasot@otenet.gr
Greece	GEMKA-Karidis G. & Sons OE	Lykoirygoy St. 14-16	Athens	10552	+30-210-3243000	+30-210-3249571 g_karidis@yahoo.com
Greece	Fr.Ili Raptakis	Pili Iisou 10	Iraklion - Crete		+30-2810-285000	+30-2810-280165 raptakis_keys@her.forthnet.gr
Guinea	Soguintec S.A.	Calle Abilio Balboa	Malabo - Provincia del Bioko Norte		+240-556618	
Holland	Duitman B.V.	Aquamarijnstraat 5	7554 NM - Hengelo		+31-74-2452520	+31-74-2452522 info@duitman.nl
Holland	H. Cillekens & Zn. B.V.	Metaalweg, 4	JB Roermond	6045	+31-475-325147	+31-475-325148 info@hcillekens.nl
Holland	Steenhauer B.V.	Oude Raadhuisstraat 1	Ap Leidschendam	2266	+31-70-3177262	+31-70-3177333 info@steenhauer.nl
Hong Kong	Professional Lock Centre Co. Ltd.	Unit A-D, 9/F. Gemstar Tower, 23 Man Lock Street	Hunghom, Kowloon, Hong Kong		+852-23302268	+852-23302082 plc@plc.com.hk
Hungary	Kaba Elzett	Megyeri út 51	Budapest	1044	+36-1-3501011	+36-1-3290692 info@elzett.hu
India	Minda Silca Engineering Ltd.	Plot No. 37, Toy City	Greater Noida	201308	+91-987-397630 +91-987-397631	+91-120-2351301 info@mindasilca.in
Iran	Klidavarshayan Co.	No.73 Stakhr. St - Emam Khomaini Ave.	Tehran		+98-216-6702757	+98-216-735649 klidavar@yahoo.com
Israel	A.M.C.I. Locksmith Supply Ltd.	22 Efal Street Kiryat Aryeh P.O.Box 3667	Petah Tikva	49130	+972-3-9230331	+972-3-9230332 amci@bezeqint.net
Italy	SILCA S.p.A.	Via Podgora, 20 (Z.I.)	Vittorio Veneto - TV	31029	+39-0438-9136	+39-0438-913800 silca@silca.it
Japan	Clover Co. Ltd	1-2-40 Haradanaka, Toyonaka-shi	Osaka	561- 0807	+81-6-6844-2111	+81-6-6844-1147 info@cloverkey.co.jp

COUNTRY	COMPANY	ADDRESS	CITY	AREA CODE	PHONE	FAX e-mail
Kenya	MPPS Ltd.	P.O. Box 31347	Nairobi		+254-20-6532913 +254-20-6533370	+254-20-6533369 mpps@swiftkenya.com
Kuwait	Hasawi & Sabano Co. For Gen.Trad.	P.O. Box 42105	Kuwait City	70652	+965-24832505	+965-2622778 sabanokuwait@sabano.com
Latvia	Solo F Ltd.	Salaspils 12	Riga	1057	+371-7278359	+371-7876901 solo.f@apollo.lv
Lebanon	Mouawad Books & Stationary Sarl.	Mouawad Str. Mouawad Center, 60094 Jal el Dib	Beyrouth		+961-4-711202	+961-4-11206 hicham.mouawad@mouawadmb.com
Macedonia	Panevski & Sinovi	Llidska , 11	Kumanovo	1300	+389-31-411545	+389-31-412411 panevski@mt.net.mk
Malta	Unimark Ltd.	32, Zerafa Str.	Hmr 03 Marsa		+356-21-231540	+356-241319 pl@waldonet.net.mt
Mexico	Corporacion Cerrajera Alba Sa De Cv	Circuito Gustavo BAZ, 16 Atizapan de Zaragoza	Messico D.F.	52966	+52-55-53667200	+52-55-53667291 info@kaba-mexico.com
Mozambique	Davel Importacao Comercio e Servicos	Rua Do Carmo NR.54 - 3° Solat	Coimbra	3000	+351 239833858	+351 914506747
New Zealand	Baber LSC Limited	Unit 5, 6 Argus Place Auckland	Glenfield	1310	+649-444-5117	+649-444-5119 info@babersc.co.nz
Nigeria	Chilex Security Products Ltd.	12, Olowu Street P.O. Box 5153	Ikeja - Lagos		+234-1-4965005	+234-1-4965005 chilexproducts@yahoo.co.uk
Norway	Prodib Ab	Montorgat 16	Eskilstuna	632 29	+46-16-168000	+46-16-145590 prodib@prodib.se
Poland	Dar-Mar	ul. Napoleona, 17	Kobylka	05-230	+48-22-7710118	+48-22-7710118 dar-mar@dar-mar.pl
Poland	Z.P.U.H. Expres Wojcieck Kowalczyk	32-447 Siepraw 795	Siepraw		+48-1227-46365	+48-1227-46365 expres@expres.pl
Portugal	Casa Das Chaves Da Falagueira Ltda	Estrada Da Falagueira 5B	Amadora	2701	+351-214936430	+351-214912403 ch.falagueira@mail.telepac.pt
Portugal	Luso Chav'	Av. Rodrigues de Freitas, 199-A	Porto	4000-303	+351-22-5104702	+351-22-5361248 geral@lusochav.pt
Romania	M&C Business S.r.l.	36, Badea Cartan Street 2nd District	Bucharest	20064	+40-213118602	+40-212120155 main_office@mcbusiness.ro
Russia	Strazh	16/2, pt. Komsomolskiy	Moscow	119021	+7 495 7083440	+7-495-7083292
Russia	O.O.O. Peter Key	Mihaylovsky Pereulok, 7b	Saint Petersburg	198095	+7-812-2520241	+7-812-2523885 peterkey@peterkey.ru
Saudi Arabia	Fahd Omar Bamashmous Est.	P.O. Box 20919	Jeddah	21465	+966-2-6422588	+966-2-6447238 bamashmous_est@hotmail.com
Serbia	Silkon D.O.O.	29, Novembra 70	Belgrade	11000	+381-11-2080200	+381-11-3290017 silkon@ptt.yu
Singapore	Silca Soxxi Pte. Ltd.	21 Toh Guan Rd. East #01-12 Toh Guan Centre	Singapore	608609	+65-6316-8100	+65-6316-4470 info@silca.sg
Slovakia	H&B Slovakia s.r.o.	Ovsistske Nam. 1	Bratislava	85104	+421-2-6252-0032 +421-2-6252-0033	+421-2-6252-0034 hb.slovakia@kluce-hb.sk
South Africa	Sanlic International (Pty) Ltd.	46, Hulbert Street New Centre	Johannesburg		+27-11-4939717	+27-11-6831312 acoetzee@voltex.co.za
Spain	Silca Key Systems S.A.	C/Santander 73/A	Barcelona	08020	+34-93-4981400	+34-93-2788004 silca@silca.es
Sweden	Prodib Ab	Montorgat 16	Eskilstuna	632 29	+46-16-168000	+46-16-145590 prodib@prodib.se
Switzerland	Robert Rieffel Ag	Widenholzstrasse 8	Wallisellen	8304	+41-44-8773333	+41-44-8773322 info@rieffel.ch
Syria	Muheiddin Arabi Katbi	P.O. Box 1322	Damascus		+963-11-2212407 +963-11-2224588	+963-11-2224588 +963-11-3737001
Taiwan	Global Tecspiro Ltd.	11F-2 N.42-2 Lian Sheng St.	Jhongho City Taipei		+886-2-22494028	+886-2-22425735 vincent@carkey.tw
Turkey	Kadiköy Anahtar San.Ve.Tic.Ltd.Sti.	Osmanaja Mah.Nüzhet Efendi Sk.No.56	Kadiköy - Istanbul		+90-216-4145254	+90-216-3475488 info@kadikoyanahtar.net
U.A.E.	Sabano Trading Co.Llc	P.O. Box 32075	Dubai		+971-4-2682400	+971-4-2622778 sabanodubai@sabano.com
Ukraine	Service-Centre Kopir	Segedskaya 12	Odessa	65009	+38-487-433196	+38-487-190777 v@key.odessa.ua
United Kingdom	SILCA Ltd.	6 Lloyds Court Manor Royal	Crawley	RH10 9QU	+44-1293-531134	+44-1293-531108 sales@silcaltd.co.uk
U.S.A.	Kaba Ilco Corp.	400 Jeffreys Road, P.O. Box 2627	Rocky Mount NC 27804		+1-252-446-3321	+1-252-446-4702 custsvc@irm.kaba.com
Venezuela	La Casa del Cerrajero C.A.	Av. Principal de Maripérez	Caracas		+58-212-793-0083	+58-212-781-8692 cerrajero@cantv.net
Yemen	Sabano Trading Co.Llc	P.O. Box 32075	Dubai U.A.E.		+971-4-2682400	+971-4-2622778 sabanodubai@sabano.com



SILCA S.p.A.

Via Podgora, 20 (Z.I.)
31029 VITTORIO VENETO (TV)
Tel. 0438 9136 Fax 0438 913800
E-mail: silca@silca.it
www.silca.biz

Members of the Kaba Group

