



MICROMETER ADJUSTMENT

TORQUE WRENCHES

64534 & 64535



These instructions accompanying the product are the original instructions. This document is part of the product, keep it for the life of the product passing it on to any subsequent holder of the product. Read all these instructions before assembling, operating or maintaining this product.

This manual has been compiled by Draper Tools describing the purpose for which the product has been designed, and contains all the necessary information to ensure its correct and safe use. By following all the general safety instructions contained in this manual, it will ensure both product and operator safety, together with longer life of the product itself.

All photographs and drawings in this manual are supplied by Draper Tools to help illustrate the operation of the product.

Whilst every effort has been made to ensure the accuracy of information contained in this manual, the Draper Tools policy of continuous improvement determines the right to make modifications without prior warning.

1. TITLE PAGE

1.1 INTRODUCTION:

USER MANUAL FOR: Micrometer Adjustment Torque Wrenches

Stock No: 64534 & 64535

Part No: 3004A/BK & 3001A/BK

1.2 REVISIONS:

Date first published December 2020.

As our user manuals are continually updated, users should make sure that they use the very latest version.

Downloads are available from: <http://drapertools.com/manuals>

Draper Tools Limited, Hursley Road, Chandler's Ford, Eastleigh, Hampshire, SO53 1YF. UK

Website: drapertools.com, **Product Help Line:** +44 (0) 23 8049 4344,

General Fax: +44 (0) 23 8026 0784

1.3 UNDERSTANDING THIS MANUALS SAFETY CONTENT:

Warning! – Information that draws attention to the risk of injury or death.

Important – Information that draws attention to the risk of damage to the product or surroundings.

1.4 COPYRIGHT © NOTICE:

Copyright © Draper Tools Limited.

Permission is granted to reproduce this publication for personal and educational use only.

Commercial copying, redistribution, hiring or lending is prohibited.

No part of this publication may be stored in a retrieval system or transmitted in any other form or means without written permission from Draper Tools Limited.

In all cases this copyright notice must remain intact.

2. WARRANTY

2.1 WARRANTY

Draper tools have been carefully tested and inspected before shipment and are guaranteed to be free from defective materials and workmanship.

Should the tool develop a fault, please return the complete tool to your nearest distributor or contact:

Draper Tools Limited, Chandler's Ford, Eastleigh, Hampshire, SO53 1YF. England.

Telephone Sales Desk: +44 (0) 8049 4333 or Product Help Line +44 (0) 23 8049 4344.

A proof of purchase **must** be provided with the tool.

If upon inspection it is found that the fault occurring is due to defective materials or workmanship, repairs will be carried out free of charge. This warranty period covering labour is 12 months from the date of purchase. This warranty does not apply to any consumable parts, any type of battery or normal wear and tear, nor does it cover any damage caused by misuse, careless or unsafe handling, alterations, accidents, or repairs attempted or made by any personnel other than the authorised Draper warranty repair agent.

Note: If the tool is found not to be within the terms of warranty, repairs and carriage charges will be quoted and made accordingly.

This warranty applies in lieu of any other warranty expressed or implied and variations of its terms are not authorised.

Your Draper warranty is not effective unless you can produce upon request a dated receipt or invoice to verify your proof of purchase within the warranty period.

Please note that this warranty is an additional benefit and does not affect your statutory rights.

Draper Tools Limited.

3. INTRODUCTION

3.1 SCOPE

This torque wrench is used to apply a specific torque to a fastener such as a nut or bolt.

3.2 SPECIFICATION

Stock No. 64534 64535
Part no. 3004A/BK 3001A/BK
Square drive size 3/8" 1/2" Marked range
..... 10-80Nm/ 30-210Nm/
..... 88.5-708lb-in 22.1-154.9lb-ft
Overall length 275mm 465mm

Whilst every effort has been made to ensure that the accuracy of information given in this manual is correct at time of going to print, the Draper Tools policy of continuous improvement determines the right to change specification without notice.

3.3 CONVERSION CHART

	mN/m millinewton- metre	cN/m centinewton- metre	N/m newton- metre	daN/m decanewton- metre	cm/kg centimetre- kg	m/kg metre- kg	in-oz inch- ounce	in-lb inch- pound	ft-lb foot- pound
1mN/m	1	0.1	0.001	0.0001	0.0102	0.000102	0.1416	0.00885	0.000738
1cN/m	10	1	0.01	0.001	0.102	0.00102	1.416	0.0885	0.00738
1N/m	1000	100	1	0.1	10.2	0.102	141.6	8.85	0.738
1daN/m	10000	1000	10	1	102	1.02	1416	88.5	7.38
1cm/kg	98	9.8	0.098	0.0098	1	0.01	13.9	0.868	0.0723
1m/kg	9810	981	9.81	0.98	100	1	1390	86.8	7.23
1in-oz	7.06	0.706	0.00706	0.0007	0.072	0.00072	1	0.063	0.0052
1in-lb	112.9	11.29	0.1129	0.01129	1.152	0.0115	16	1	0.083
1ft-lb	1355	35	1.355	0.1135	13.8	0.138	192	12	1

4. SAFETY INSTRUCTIONS

4.1 GENERAL SAFETY INSTRUCTIONS

WARNING! Never use the torque wrench to undo bolts, nuts or fasteners, as this will damage the ratchet and the calibrated setting

If the torque fails to function correctly for any of the following reasons, return the torque wrench to your local Draper Tools stockist. A repair service is available.

1. Ratchet fails to function.
2. Handle lock fails to function.
3. Handle lock nut comes loose.
4. No audible click.
5. Handle does not break at set torque.
6. Out of calibration.
7. Always refer to manufacturer's literature, workshop manual or Haynes manual for recommended TORQUE SETTINGS and if applicable the sequence for tightening and final torquing of fasteners.

IMPORTANT: The torque wrenches detailed in this instruction leaflet are for right hand torquing only. They are not designed for left hand thread use.

- This torque wrench is designed for general purpose use.
- If critical torque measurement is required, it is recommended the torque wrench is independently calibrated before first use and that the user puts in place a re-calibration schedule appropriate for the application.
- Draper Tools offer a full range of precision torque wrenches for this type of application, contact your stockist for further details.

5. TECHNICAL DESCRIPTION

5.1 IDENTIFICATION

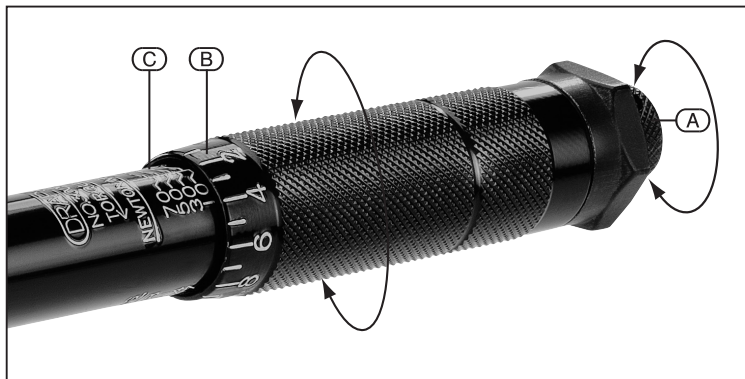

NOTE: Always set by turning the handle in the clockwise direction.

1. To unlock handle, turn locking screw anti-clockwise (A).
2. Turn handle clockwise until the correct whole number of the setting is reached (B). (NOTE: it may be necessary to loosen the locking screw more than once during the setting procedure).
3. Continue to turn the handle for any additional increments to obtain the final setting (C).
4. Lock handle, turn locking screw clockwise (A).
5. When the torque wrench is not in use, ensure the torque wrench is set to its minimum setting and NOT below - otherwise it will effect the accuracy and calibration.

6. OPERATION AND USE

- **IMPORTANT:**

Always use the correct size socket and if necessary, accessory.

Apply a steady pull to the handle of the torque wrench. When the applied torque is reached, this will be indicated by the following:

1. Audible click: NOTE: The click will be quieter at lower torque settings.
2. Touch: The handle will be felt to “break away” at the point of the set torque. NOTE: the “break away” will be very gentle at low torque settings.
3. Visually: The handle will be seen to “break away” at the point of the set torque. WARNING: it is recommended that the torque wrench is tested on a non-critical fixing before use so that the user is able to determine the “break away” point.

- **WARNING:**

- Never continue to pull on the torque wrench once the set torque is reached, as this will result in an incorrect torque being applied and possible damage to parts.
- If the torque wrench has not been used i.e. new or has been in storage for some time, operate it several times at a low torque setting, which allows the internal lubrication to recoat working parts.
- When the torque wrench is not in use, ensure adjustment at the lowest torque setting, but NOT below.
- Do not turn adjustment below lowest torque setting.
- Never use the torque wrench to undo nuts, bolts or fasteners. This will result in the ratchet mechanism being damaged.
- The tool is rugged and designed for workshop use, but it is also a precision measuring instrument and should be treated as such.
- Clean wrench by wiping. Do not immerse in any type of cleaner which will affect the internal lubrication.
- Under no circumstances should any attempt be made to adjust or repair the torque wrench. A full repair and calibration service is available on request. A charge will be made accordingly.
- It is recommended that a re-calibration schedule is put in place by the user to ensure the torque wrench is performing within its design criteria.

6. OPERATION AND USE

1.1 SETTING EXAMPLE 3/8" SQUARE DRIVE - FIGS. 2 - 5

Stock No.64534 Part No.3004A/BK

Measuring Nm

Torque wrench set to 36Nm.

1. Unlock handle.
2. 30Nm. whole number (Fig.2).
3. 1 div. on handle = 1Nm.

6 div. = 6Nm.

$30 + 6 = 36\text{Nm.}$ (Fig.3).

4. Lock handle.

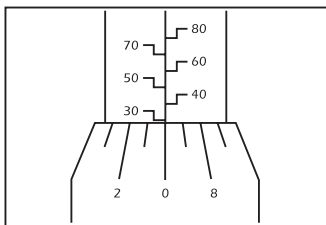

FIG.2

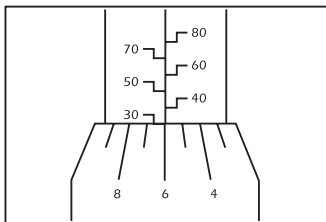

FIG.3

Measuring Ft/Lbs

Torque wrench set to 318.8 in-lb.

1. Unlock handle.
2. 266 in-lb. whole number (Fig.4).
3. 1 div. on handle = 8.8 in-lb.

6 div. = 52.8 in-lb.

$266 + 52.8 = 318.8\text{ in-lb.}$ (Fig.5).

4. Lock handle.

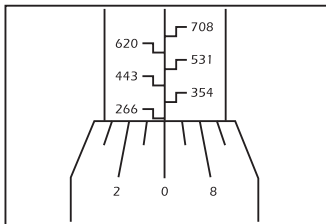

FIG.4

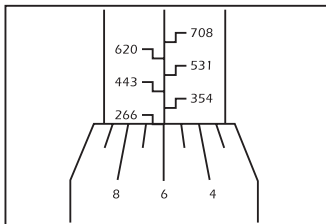

FIG.5

6. OPERATION AND USE

1.1 SETTING EXAMPLE 1/2" SQUARE DRIVE - FIGS. 6 - 9

Stock No.64535 Part No.3001A/BK

Measuring Nm

Torque wrench set to 96Nm.

1. Unlock handle.
2. 90Nm. whole number (Fig.6).
3. 1 div. on handle = 1Nm.

6 div. = 6Nm.

$90 + 6 = 96\text{Nm.}$ (Fig.7).

4. Lock handle.

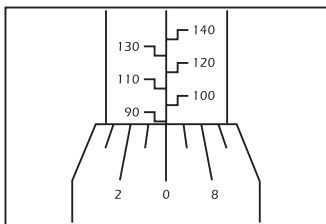

FIG.6

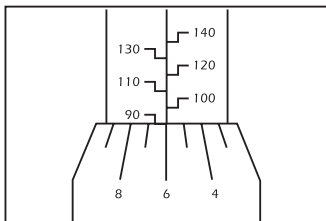

FIG.7

Measuring Ft/Lbs

Torque wrench set to 70.84 in-lb.

1. Unlock handle.
2. 66.4 ft-lb. whole number (Fig.8).
3. 1 div. on handle = 0.74 ft-lb.

6 div. = 4.44 ft-lb.

$66.4 + 4.44 = 70.84\text{ ft-lb.}$ (Fig.9).

4. Lock handle.

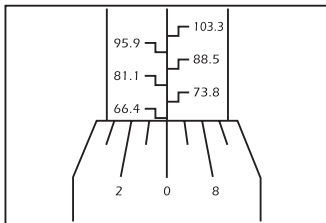

FIG.8

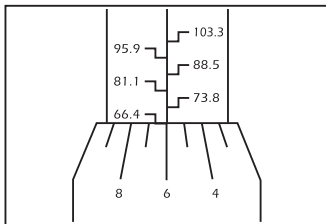

FIG.9

CONTACTS

Draper Tools Limited, Hursley Road,
Chandler's Ford, Eastleigh, Hampshire. SO53 1YF. U.K.

Help Line: (023) 8049 4344

Sales Desk: (023) 8049 4333

Internet: drapertools.com

E-mail: sales@drapertools.com

General Enquiries: (023) 8026 6355

Service/Warranty Repair Agent:

For aftersales servicing or warranty repairs, please contact the Draper Tools Help Line for details of an agent in your local area.

YOUR DRAPER STOCKIST

SQMC1220

©Published by Draper Tools Limited.

No part of this publication may be reproduced, stored in a retrieval system or transmitted in any form or by any means, electronic, mechanical photocopying, recording or otherwise without prior permission in writing from Draper Tools Ltd.