

**DRAPER**

**EXPERT**

**EN**

Original Instructions  
Version 2  
February 2026

4000W PETROL

# GENERATOR WITH WHEELS

**23984**



**UK  
CA** **CE**

# 1. Preface

These are the original product instructions. This document is part of the product; retain it for the life of the product, passing it on to subsequent holders. Read this manual in full before attempting to assemble, operate or maintain this product.

This Draper Tools manual describes the purpose of the product and contains all the necessary information to ensure its correct and safe use. Following all the instructions and guidance in this manual will ensure the safety of both the product and the operator and increase the lifespan of the product.

All photographs and drawings within this manual are supplied by Draper Tools to help illustrate correct operation of the product.

Every effort has been made to ensure the information contained in this manual is accurate. However, Draper Tools reserves the right to amend this document without prior warning. Always use the latest version of the product manual.

## 1.1 Product Reference

**User Manual for:** 4000W Petrol Generator with Wheels

**Stock No:** 23984

**Part No:** PG43W

## 1.2 Revisions

**Version 1:** May 2016  
First release

**Version 2:** February 2026

As our manuals are continually updated, always ensure that the latest version is used.

Please visit [drapertools.com/manuals](http://drapertools.com/manuals) for the latest version of this manual and the associated parts list, if applicable.

## 1.3 Understanding the Safety Content of This Manual



**WARNING!** – Situations or actions that may result in personal injury or death.



**CAUTION!** – Situations or actions that may result in damage to the product or surroundings.

**Important:** – Information or instructions of particular importance.

## 1.4 Copyright © Notice

Copyright © Draper Tools Limited.

Permission is granted to reproduce this manual for personal and educational use **ONLY**. Commercial copying, redistribution, hiring or lending is strictly prohibited.

No part of this manual may be stored in a retrieval system or transmitted in any other form or means without written permission from Draper Tools Limited.

In all cases, this copyright notice must remain intact.

1. Preface	2	9. Maintenance and Troubleshooting	16-19
1.1 Product Reference	2	9.1 General Maintenance	16
1.2 Revisions	2	9.2 Draining the Fuel	16
1.3 Understanding the Safety Content of This Manual	2	9.3 Draining the Engine Oil	16
1.4 Copyright © Notice	2	9.4 Air Filter Care	17
2. Contents	3	9.5 Spark Plug Care	17
3. Product Introduction	4	9.6 Fuel Filter Care	17
3.1 Intended Use	4	9.7 Maintenance Schedule	18
3.2 Specification	4	9.8 Storing the Product	18
4. Health and Safety Information	5-7	9.9 Troubleshooting	19
4.1 General Health and Safety Precautions	5	10. Associated Risks and Preventative Measures	20-22
4.2 Additional Health and Safety Instructions for This Machine	6	10.1 Risk of Electrocutation and Fire	20
4.3 Health and Safety Information for Machines with a Petrol Engine	6	10.2 Risk of Fire	20
4.4 Working With Lead-Acid and Other Vehicle Batteries	7	10.3 Risk of Injury and Property Damage When Transporting the Generator	21
4.5 Residual Risk	7	10.4 Risk of Inhalation of Toxic Substances	21
5. Identification and Unpacking	8-9	10.5 Risk of Unsafe Operation	22
5.1 Product Overview	8	10.6 Risk of Hot Surfaces	22
5.2 What's in the Box?	9	10.7 Risk of Injury from Moving Parts	22
5.3 Packaging	9	10.8 Risk of Injury During Lifting	22
6. Assembling the Generator	10	11. Spares, Returns and Disposal	23
6.1 Attach the Wheels	10	12. Warranty	23
6.2 Attach the Rubber Feet	10	13. Explanation of Symbols	23
6.3 Attach the Handles	10		
7. Preparing the Generator	11-12		
7.1 Fuelling the Generator	11		
7.2 Checking and Topping Up the Engine Oil	12		
7.3 Grounding the Generator	12		
8. Operating Instructions	13-15		
8.1 Starting the Generator	13		
8.2 Stopping the Generator	14		
8.3 Connecting Appliances to the Generator	14		
8.4 Using the DC Outlet	14		
8.5 Circuit Breakers	15		
8.6 Automatic Voltage Regulator (AVR)	15		

# 3. Product Introduction

---

## 3.1 Intended Use

This product is designed for use as a power generator with dual output at 110V and 230V and also includes a 12V DC outlet. The product is powered by a four-stroke petrol engine and fitted with wheels for ease of mobility.

Any other application beyond the conditions established for use will be considered misuse. Draper Tools accepts no responsibility for improper use of this product.

Read this manual in full before attempting to assemble, operate or maintain the product, and retain it for later use.

## 3.2 Specification

Stock No.	23984
Part No.	PG43W

---

### AC output

Rated output	4,000W
Peak output	4,400W

---

### Engine

Type	Four-stroke OHV (overhead valve), single cylinder
Displacement	389cc
Cooling system	Forced air

---

### Fuel

Type	E10* (95 RON) Unleaded
Capacity	25L

---

### Engine oil

Type	SAE 10W-40
Capacity	1.1L

---

Regulation	AVR (Automatic Voltage Regulation)
------------	------------------------------------

---

Phase	Single
-------	--------

---

Output sockets	1 x 230V AC (16A), 1 x 110V AC (16A), 1 x 110V (32A), 1 x 12V DC
----------------	--

---

Continuous running time	12 hours (75% load)
-------------------------	---------------------

---

Suitable batteries (for charging)	Wet lead acid
-----------------------------------	---------------

---

### Noise emissions at 4m

Sound pressure level	77dB(A)
Guaranteed Sound power level	97dB(A)

---

Dimensions (L X W X H)	710 x 560 x 570mm
------------------------	-------------------

---

Net weight	79.7kg
------------	--------

---

\* Draper Tools recommends using an additive or stabiliser with E10 petrol so the fuel can be safely stored in the fuel tank for longer.

**Important:** Read all the Health and Safety instructions before attempting to operate, maintain or repair this product. Failure to follow these instructions may result in injury or damage to the user or product.

### 4.1 General Health and Safety Precautions

#### Training and Inspection

- Only personnel who have read and understood this manual in full and are familiar with the operation, safe working techniques and safety features of this machine may operate, adjust or maintain this product.
  - **DO NOT** allow anyone who is unfamiliar with this product or unqualified in its use to operate this machine.
  - This machine is not intended for use by children or persons with reduced physical, sensory or mental capabilities or lack of experience and knowledge unless they have been given supervision or instruction in its use by a person responsible for their safety.
  - Keep children and bystanders at a safe distance from the generator.

- Observe all standard safety precautions and good practices when working with petrol engines.
- Before every use, inspect the product and all accessories for broken, cracked, loose or corroded parts and leakages.

**Important: DO NOT** use this product if it is leaking or damaged in any way. Contact Draper Tools to discuss repair and replacement options.

- **DO NOT** allow familiarity or experience with this product to allow you to become complacent; remain alert at all times and **ALWAYS** adhere to the safety instructions listed in this manual.

#### Preparation and Intended Use

- Ensure that the surface onto which the machine is installed is flat, level, stable and capable of permanently supporting the weight of the machine.
- Ensure that the product is fully assembled, tightened and firmly fixed in place before use.
- Before use check the generator and its electrical equipment (including lines and plug connections) are not defective.
- **DO NOT** modify this product in any way and **ONLY** use spare parts supplied by Draper Tools.
- Use this product only in the manner described in this manual.
- **NEVER** stand, sit or ride on this product.
- **DO NOT** leave the machine running unattended under any circumstances; **ALWAYS** switch the machine off and allow it to cool before walking away.
- **DO NOT** exceed the maximum working capacities of this machine.

- **DO NOT** cover or obstruct any ventilation points or grilles.



**CAUTION!** This product is not weatherproof and **MUST NOT** be exposed to direct sunlight, high ambient temperatures, rain, frost or damp, wet and high-humidity environments.

#### Work Area Safety

- Keep your work environment clear and well-lit, with bystanders at a safe distance.
- Work only in daylight or in good artificial light.
- **DO NOT** use this product near open flames or sources of heat or ignition, or in any environment where explosive substances are present.
- **NEVER** operate the engine indoors or in any confined space where dangerous carbon monoxide fumes can collect; carbon monoxide is dangerous and can cause serious injury or death in a matter of minutes.
- **DO NOT** change the engine governor settings or overspeed the engine.
- **NEVER** transport the machine while the engine is running.

#### Personal Safety

- Wear suitable PPE (personal protective equipment), including ear defenders and protective gloves.
- **ALWAYS** keep clear of heated and moving parts at all times.
- Ensure that the generator is switched off and has completely cooled before fuelling, maintaining or making any adjustment to the product.
- **DO NOT** operate this machine if you are tired or under the influence of alcohol, drugs or other medication.

#### Electrical Safety



**WARNING!** Risk of electric shock.

- This product produces enough electrical power to cause a serious shock or electrocution if it is misused.
- **NEVER** handle or operate this machine with wet hands.
- **NEVER** expose this machine to wet conditions or frost.

#### Maintenance

- Maintain the machine appropriately and correctly to prevent damage to moving parts and mechanisms.
- Have the machine serviced **ONLY** by authorised and suitably qualified personnel.
- Remove all adjustment tools before use.

## 4. Health and Safety Information

- **ALWAYS** switch off the product and allow it to completely stop and cool before attempting to refuel or perform any adjustment, maintenance or other inspection.
- Never store the equipment with petrol in the tank inside a building where fumes can reach an open flame or spark.
- Allow the engine to cool before storing it in any enclosure.
- To reduce the risk of fire, keep the engine, muffler and petrol storage area free of vegetative material and excessive grease.
- Replace worn or damaged parts for safety.
- If the fuel tank must be drained, it must be done outdoors.

### 4.2 Additional Health and Safety Instructions for this Machine

**Important:** Electrical regulations vary between regions. This product **MUST** be used in accordance with the electrical regulations applicable to the region in which it is used.

 **WARNING! This product is heavy. DO NOT attempt to carry it on your own.**

- The engine speed has been set at the factory to ensure safe operation.
  - **DO NOT** adjust the engine speed.
- Transport the machine using the handles and wheels.
- The generator **MUST** be grounded during use.
  - Connect an earth wire to the earth terminal on the generator and press the other end of the wire into the ground or attach it to an earth spike.
- Where circuit breakers are used, they must be matched to the output of the generator.
  - Incorrect circuit breakers will not provide sufficient protection against electric shock.
- **DO NOT** connect external devices to the generator until it has been switched on and allowed to run for a few minutes.
- **DO NOT** switch on external devices until **AFTER** they have been connected to the generator.
- When using extension lines or mobile distribution networks:
  - The resistance value must not exceed 1.5Ω.
  - The total length of lines with a cross-section of 1.5mm<sup>2</sup> must not exceed 60m.
  - The total length of lines with a cross-section of 2.5mm<sup>2</sup> must not exceed 100m.
- **DO NOT** connect this product to a building electrical system unless an isolation switch has been installed by a qualified electrician.
- **ALWAYS** consult a qualified electrician before

connecting this product to a building or using it in highly conductive environments.

- **NEVER** connect generators of different models and types together.
- Ensure all appropriate safety precautions are observed when transporting the machine:
  - **ALWAYS** ensure that the machine is switched off and the spark plug cover is disconnected during transportation.
  - Drain all fuel and oil from the product before transporting it and ensure that all reservoir caps are tightly sealed.  
**Important:** If transporting it in a vehicle, keep the transportation unit well-ventilated.
  - When transporting the product by hand, maintain a firm grip on the frame and keep the machine level.
  - When transporting the product in a vehicle, ensure it is kept level and strapped securely in place.
  - **ALWAYS** keep the generator upright at all times.
  - Keep the generator out of direct sunlight during transportation.
  - Remove the generator from the vehicle immediately upon arrival at your destination.

 **CAUTION! All loads MUST be unplugged from the generator before the generator is started or stopped to prevent damage to connected appliances.**

### 4.3 Health and Safety Information for Machines with a Petrol Engine

 **WARNING! During use, parts of this product become hot enough to ignite some materials.**

**DO NOT** touch the engine or exhaust during or immediately after use and allow it to cool before refuelling.

- **NEVER** remove the fuel cap while the engine is running or immediately after use.
  - Take care when opening the fuel cap after use as hot vapour may be released from the opening.
- **NEVER** place objects on the engine while it is in use and keep all air vents clear of dust, dirt and other obstructions.
- Faulty mufflers must be replaced.
- **NEVER** store the machine with fuel in the tank inside any structure where petrol fumes could reach an open flame or spark.
- To reduce the risk of fire, keep the engine, silencer and petrol storage area free from vegetation and excessive grease.

 **WARNING!**

**Petrol is highly flammable:**

- Store fuel in containers specifically designed for this purpose.
- **NEVER** use this product in environments where there is a risk of explosion.
- **NEVER** smoke in the vicinity of the machine.
- Refuel outdoors only and **DO NOT** smoke while refuelling.
- Add fuel before starting the engine; **NEVER** remove the cap of the fuel tank or add petrol while the engine is running or when the engine is hot.
- **NEVER** start the engine if you can smell petrol vapour in the air.
- If petrol is spilled, **DO NOT** attempt to start the engine but move the machine away from the area of spillage and avoid creating any source of ignition until petrol vapours have dissipated.
- Replace all fuel tank and container caps securely.

**Important:** E10 petrol is hygroscopic and attracts moisture. Read all the preparation and maintenance information relating to E10 fuel before using it in this machine. Draper Tools recommends using an additive or stabiliser with E10 petrol to extend the period that it can be safely stored in the fuel tank. **ALWAYS** read the label of any additive or stabiliser applied.

 **WARNING! The machine exhaust emits toxic carbon monoxide: a colourless, odourless gas.**

Breathing exhaust fumes can cause loss of consciousness, permanent respiratory damage and eventually death. **ONLY** operate this machine in a well-ventilated outdoor environment, well away from windows and doors. If you inhale carbon monoxide, move to a ventilated area and seek immediate medical attention.

### 4.4 Working With Lead-Acid and Other Vehicle Batteries

 **WARNING! Risk of explosive gases. Working in close proximity to lead-acid batteries is dangerous as they produce potentially explosive gases during normal operation. ALWAYS read this manual in full charging any lead-acid battery and keep your work area thoroughly ventilated. Contact Draper Tools for assistance if you are not confident in the use of this product.**

Use this manual in conjunction with the battery manufacturer manual and that of any other equipment to be used in the vicinity. Review all safety markings and rating plates present on the battery, charger and any other nearby equipment before using this product to charge a vehicle battery.

- **DO NOT** work with vehicle batteries on your own; **ALWAYS** ensure that someone is nearby to come to your aid if necessary.
- Wear complete eye and hand protection and wear suitable clothing that covers your skin appropriately.
  - Avoid touching your eyes while working with lead-acid batteries.
- Keep plenty of fresh water and soap nearby in case battery acid comes into contact with your skin, eyes or clothing.
  - If battery acid comes into contact with your skin or clothing, wash the affected area immediately with soap and water.
  - If battery acid enters your eyes, flush the eye immediately with plenty of cool and clean running water for at least 15 minutes and seek medical attention immediately.
- **NEVER** smoke or allow sparks or flames in the vicinity of the battery or engine.
- Take extra care to prevent metal objects or tools from falling onto the battery as this may cause a spark, short-circuit the battery or cause an explosion.
- **ALWAYS** remove personal metallic objects before use.
  - Lead-acid batteries can produce a short-circuit current high enough to weld metal and cause severe burns.

 **WARNING! DO NOT top up the electrolyte beyond the manufacturer's recommended level. Overfilling the battery may cause the acid content to leak.**

### 4.5 Residual Risk

The safety instructions in this manual cannot account for all possible conditions and situations that may occur. Exercise common sense and caution when using this product and protect against any additional conceivable risks.

# 5. Identification and Unpacking

Carefully remove the product from the packaging and examine it for any signs of damage that may have occurred during shipment.

If any part is damaged or missing, do not attempt to use the product. Please contact the Draper Helpline; contact details can be found at the back of this manual.

## 5.1 Product Overview

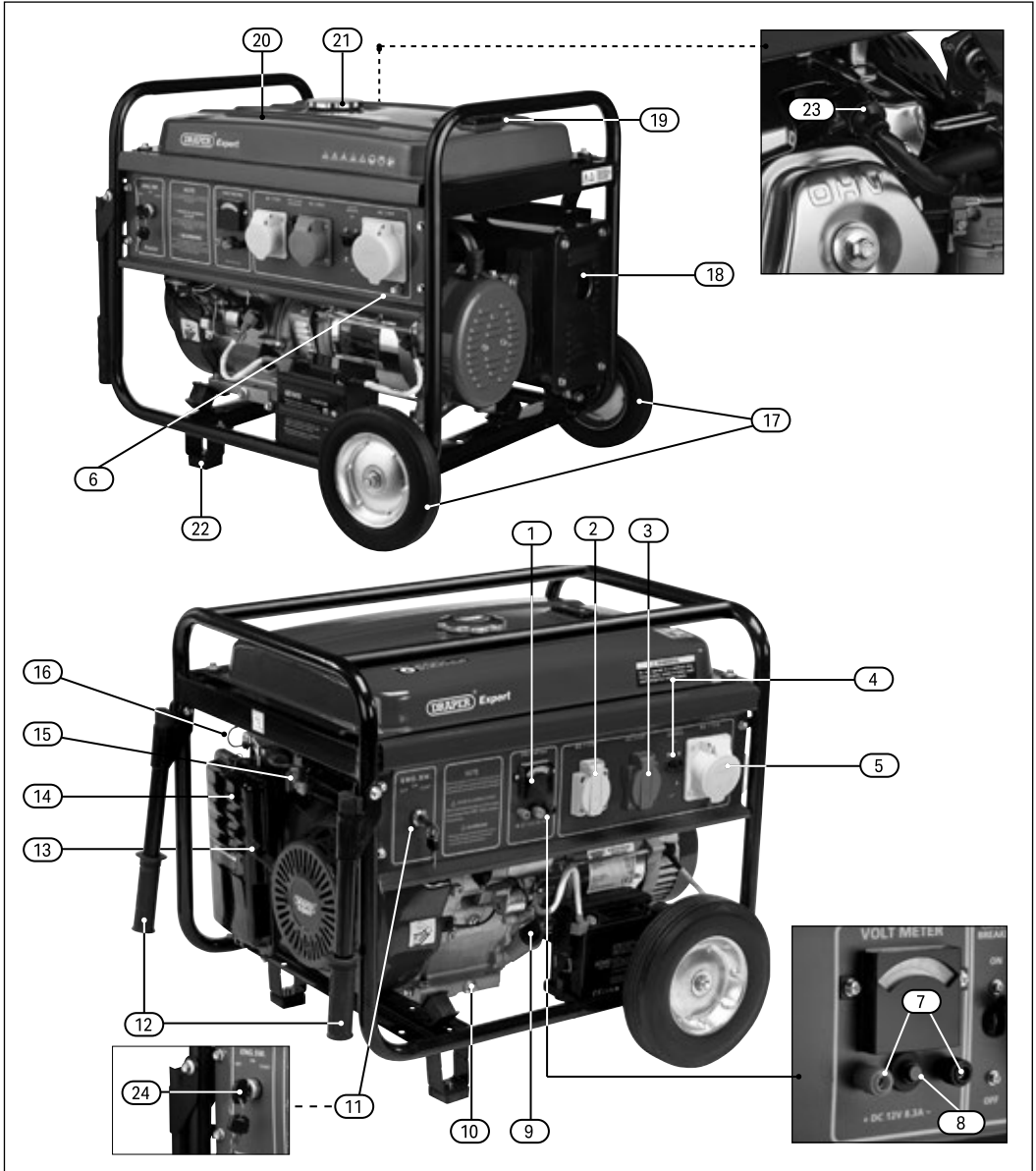

- |                                |                             |                          |
|--------------------------------|-----------------------------|--------------------------|
| 1. Voltmeter                   | 10. Oil drain bolt          | 19. Fuel gauge           |
| 2. 110V 16A AC outlet          | 11. Engine power key switch | 20. Fuel tank            |
| 3. 230V AC outlet              | 12. Transport handles       | 21. Fuel tank cap        |
| 4. AC circuit breaker          | 13. Recoil starter          | 22. 2 X Support feet     |
| 5. 110V 23A AC outlet          | 14. Air filter              | 23. Spark plug cover     |
| 6. Earth terminal              | 15. Fuel tap                | 24. 2 X Engine power key |
| 7. 12V DC outlet               | 16. Choke lever             |                          |
| 8. DC circuit breaker          | 17. 2 X Wheels              |                          |
| 9. Oil filler cap and dipstick | 18. Exhaust and muffler     |                          |

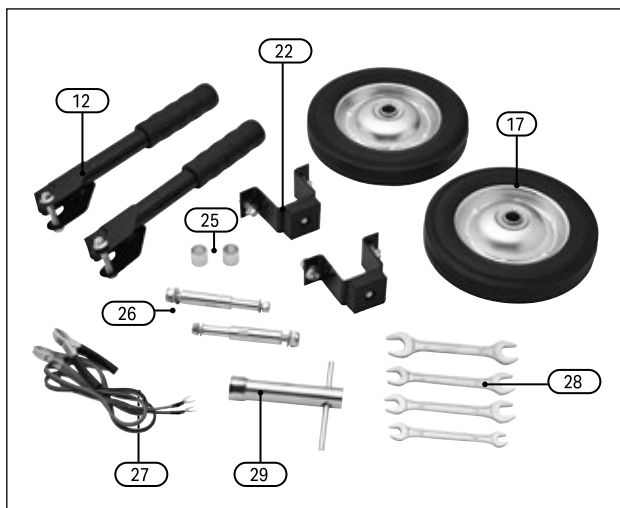

## 5.2 What's in the Box?

- 12 2 X Transport handles
- 17. 2 X Wheels
- 22 2 X Support feet
- 25. 2 X M16 spacer
- 26. 2 X Axle assembly
- 27. 12V DC battery charging leads and clamps
- 28. Combinations spanners
- 29. Spark plug spanner (body & handle)

## 5.3 Packaging

Keep the product packaging for the duration of the warranty period in case the product needs to be returned for repair.



**WARNING! Keep packaging materials out of reach of children. Dispose of packaging correctly and responsibly and in accordance with local regulations.**

Please visit [drapertools.com](http://drapertools.com) for our full range of accessories and consumables.

## 6. Assembling the Generator

**Important:** Before setting up this product, read and understand all the safety instructions listed in this manual. **DO NOT** overtighten the fixings as this may impair the use of the product.

### 6.1 Attach the Wheels (Fig.1)

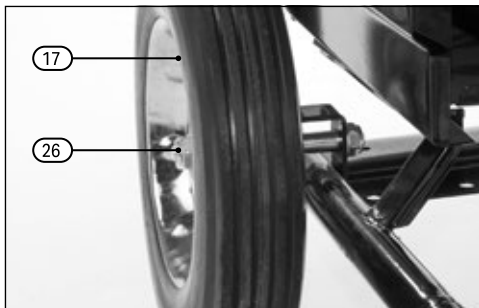

Fig. 1

1. Place an M16 spacer (25) inside each wheel bracket on the base of the generator frame.
2. Remove the nuts and washers from the ends of each axle assembly (26).
3. Insert the narrow side of the axles through the brackets at the front of the generator frame.
4. Slide a wheel (17) onto each axle with the raised bore extending inwards and secure them in place with the removed nuts and washers.

### 6.2 Attach the Support Feet (Fig.2)

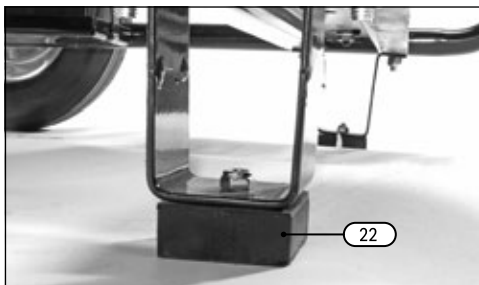

Fig. 2

1. Remove the nuts and bolts from the top plates of the support feet (22) assemblies.
2. Position the top plates of the feet assemblies beneath the holes at the back of the generator frame.
3. Pass the bolts down through the frame and feet assemblies and secure them in place using the nuts.

### 6.3 Attach the Handles (Fig.3)



Fig. 3

1. Remove the nuts and bolts from the brackets of the transport handle (12).
2. Place the brackets of the transport handle assemblies, with the open side facing downward, around the vertical frame at the back of the generator.
3. Use the bolts and nuts to secure the handles in place.

## 7.1 Fuelling the Generator (Fig.4 - Fig.6)

 **CAUTION!** This machine is shipped **WITHOUT** fuel. Check the fuel level before **EVERY** use and top up as appropriate. **NEVER** attempt to run the engine on an empty fuel tank.

**Important:** This product must be used with high-quality unleaded fuel **ONLY**. **ALWAYS** use automotive petrol suitable for four-stroke engines; **DO NOT** mix fuel and oil. Draper Tools recommends E5 or E10 (95 RON) automotive fuel, with an appropriate additive or stabiliser, for use with this product. Damage caused by failure to add fuel or by the use of incorrect or poor-quality fuel is not covered by your warranty.

 **CAUTION!** E10 petrol is hygroscopic and attracts moisture, which may damage the fuel system if stored in the product for more than four weeks.

E10 petrol should be used within 30 days of purchase. Some petrol brands contain other quantities of ethanol. **DO NOT** use fuels with more than 10% ethanol in Draper products.

**ALWAYS** store and dispose of fuels responsibly and in accordance with local regulations.

 **WARNING!** **ALWAYS** fuel the machine in a well-ventilated area away from sources of ignition. Store fuel only for short periods, away from direct sunlight and heat sources, and only in containers specifically designed for that purpose. Avoid prolonged contact with the skin and inhalation of petrol vapour.

### To fuel the machine:

- Disconnect the spark plug cover (23).

1. Remove the fuel tank cap (21).

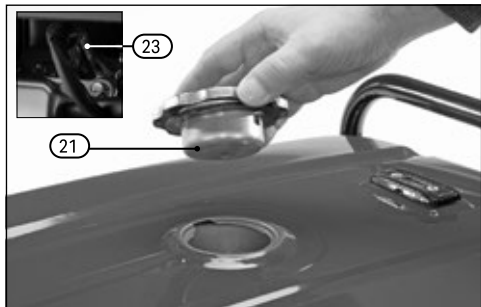



Fig. 4

 **WARNING!** If the generator has been recently used, hot steam may vent from the fuel tank outlet. Take care when opening the fuel tank.

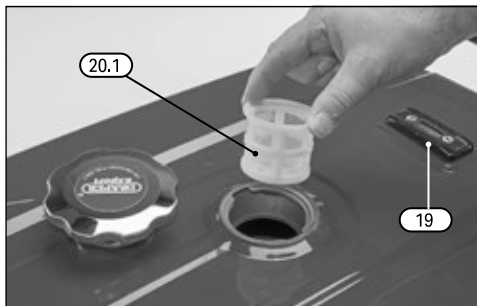

Fig. 5

2. Ensure that the fuel filter (20.1) is in place.

**Important:** **DO NOT** add fuel to the tank if the fuel filter is missing or damaged.

3. Carefully pour fuel into the tank (20) until the fuel gauge (19) indicates that the tank is full.

 **CAUTION!** **DO NOT** overfill the fuel tank; **ALWAYS** leave an air gap above the fuel level. **NEVER** allow dust, dirt, water or dirty fuel to enter the fuel tank. Clean up any spillages **IMMEDIATELY**.



Fig. 6

4. Refit the fuel tank cap, ensuring it is properly fitted and securely tightened.

5. Reconnect the spark plug cover when the machine is ready for use.

**Important:** Ensure that the notches in the fuel tank opening and the fuel filter are aligned when replacing the cap.

**Important:** Move the generator at least 4m (12") away from the fuelling area before starting the engine.

# 7. Preparing the Generator

## 7.2 Checking and Topping Up the Engine Oil (Fig.7)

 **CAUTION!** This machine is **NOT** supplied with engine oil. Check the engine oil level before every use. Running the machine with a low oil level oil may cause serious damage to the engine and is not covered by your warranty.

**Important:** Use SAE 15W-40 oil with this machine.

1. Ensure that the generator is switched off and has completely cooled, then place it on a stable and level surface.
2. Rotate the oil filler cap (9) anticlockwise to remove it from the reservoir and clean it.



Fig. 7

3. Insert the oil filler cap back into the reservoir and remove it again.  
**Important: DO NOT** screw the filler cap into place when checking the oil level; insert the cap into the reservoir and remove it again.
4. Inspect the oil level on the oil filler cap against the **'MIN'** and **'MAX'** level markings:
5. If the oil is below the **'MIN'** level marking, top up with SAE 15W-40 until the **'MAX'** marking is reached.
6. If the oil has become contaminated or discoloured, drain and replace the oil; see section **9.3 Draining the Engine Oil**.

 **CAUTION!** **DO NOT** overfill the oil as this may cause the oil to overflow into the air filter.

**Important:** The motor on this engine is fitted with a low oil sensor. If the oil level drops too low, the engine will stop and cannot be started until the oil level is topped up. Attempting to start the engine with low oil levels may still cause significant damage to the engine components due to insufficient lubrication.

## 7.3 Grounding the Generator (Fig.8)

 **WARNING!** Risk of electric shock. The generator **MUST** be grounded before use.

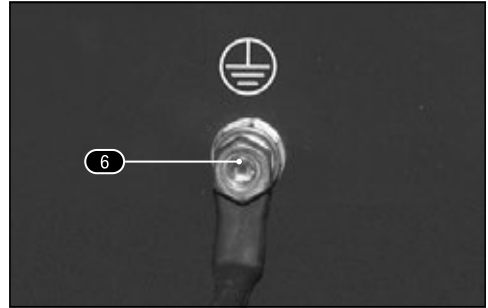

Fig. 8

To ground the product, tighten the earth terminal nut (6) against a grounding wire and attach the other end to a grounding rod (not supplied), which must be inserted into the ground.

**DO NOT** use this product without connecting it to earth.

# 8. Operating Instructions

**Important:** Before operating this product, read and understand all the safety instructions listed in this manual. Ensure that the generator is correctly prepared before use; see section 7. **Preparing the Generator.**

**Important:** The first 25 hours of use are considered the break-in period for this engine. During this time, **DO NOT** operate the engine at less than 75% of the load limit.

**Important:** Generators vibrate during operation. Periodically inspect the power plugs of connected appliances for vibration damage during and after use with the generator. If the generator vibrates excessively while operating, switch it off, allow it to cool and investigate the cause before continuing.

## 8.1 Starting the Generator (Fig.9 - Fig.12)

**CAUTION!** This machine is **NOT** shipped with fuel or oil. **DO NOT** attempt to start the engine until both the fuel tank and engine oil have been checked and topped up accordingly.

**CAUTION!** NEVER start the generator if it is already connected to a load.

**Important:** **DO NOT** start the generator until it is in its operating position. **NEVER** travel with the machine switched on.

**WARNING!** NEVER operate this product indoors or in enclosed spaces.

1. Ensure that the oil and fuel tanks are filled and that the engine is correctly grounded.
2. Ensure that the spark plug cover (23) is connected and turn the fuel tap (15) to the 'ON' position.

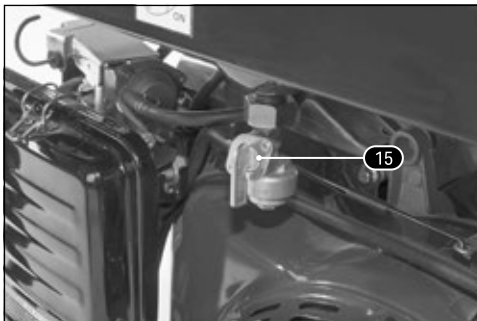

Fig. 9

3. Turn the engine power switch (11) to the 'ON' (I) position.

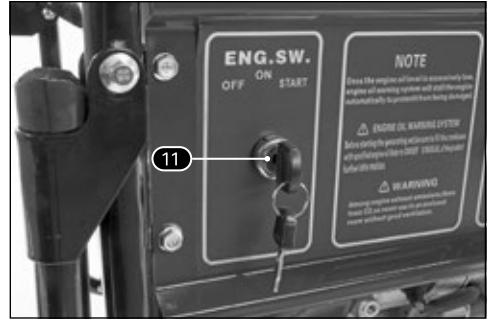



Fig. 10

4. Move the choke lever (16) to the appropriate position:
  - Cold start: Closed |  | position
  - Warm start: Open |  | position

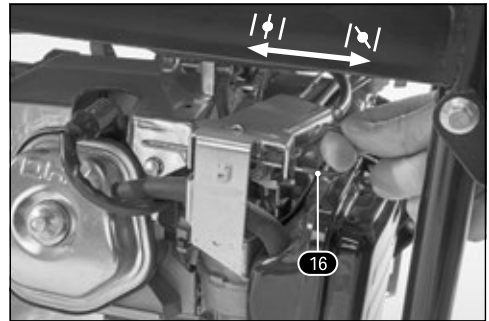

Fig. 11

5. Slowly pull on the recoil starter (13) until resistance is felt, then pull it out rapidly to start the engine.

**Important:** You may need to do this several times.

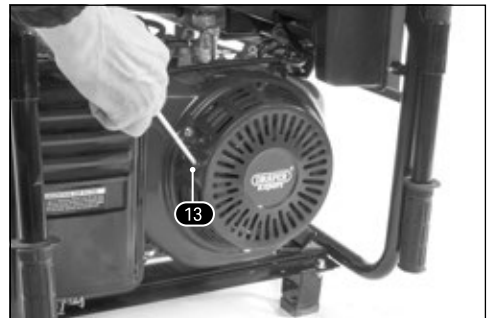



Fig. 12

## 8. Operating Instructions

---



**CAUTION! DO NOT attempt to start the engine when the recoil starter is fully retracted. DO NOT allow the recoil starter to snap back against the engine. Return it gently to prevent damage to the starter.**

6. If you are performing a cold start:
  - Allow the engine to run with no load for a few minutes to allow it to warm up.
  - Move the choke lever to the Open |  | position.

### 8.2 Stopping the Generator

**Important:** Except in emergency situations, **ALWAYS** switch off and disconnect all connected appliances before switching off the generator. Failure to do so may damage the appliances.

1. Switch off and unplug any connected appliances from the generator.
2. Allow the engine to idle for a few minutes.
3. Move the engine power switch (11) to the '**OFF**' (O) position.
4. Turn the fuel tap (15) to the '**OFF**' position.

**Important: IMMEDIATELY** switch off the generator if any of the following occur:

- Excessive engine noise, e.g., knocking or rattling
- The circuit breakers behave abnormally
- Smoke or a strong odour is emitted from anywhere other than the generator exhaust

**Important: ALWAYS** ensure that the engine power switch is in the '**OFF**' (O) position while the generator is not in use.

### 8.3 Connecting AC Appliances to the Generator



**CAUTION! DO NOT connect a load until the generator engine is running and has warmed up. Connected appliances MUST NOT be switched on until after they have been connected to the generator.**

**Important: ALWAYS** ensure that the external appliance is connected to the correct voltage outlet.

**Important: ALWAYS** check the rating plate of external appliances **BEFORE** connecting them to the generator. This generator is rated at 4,000W. The combined load from all connected appliances must **NOT** exceed this value.

1. Start the generator engine and allow it to run with no load for a few minutes; see section **8.1 Starting the Generator**.
2. Ensure that the AC circuit breaker (4) is in the '**OFF**' (O) position.
3. Ensure that the external appliance is switched off and plug its power cord into the correct outlet as appropriate.
4. Switch the AC circuit breakers to the '**ON**' position.

**Important:** After each external appliance is connected, allow a few minutes for the generator to stabilise before connecting the next appliance.

### Notes on Connecting Appliances

- If the 110V AC, 230V AC and 12V DC outlets are in use at the same time, the DC circuit breaker (8) may trip.
- This generator can withstand short voltage spikes of up to 4400W

**Important:** Motorised products require additional energy upon start-up. Some products rated at below 4,000W may fail to start if their starting current significantly exceeds that value.

- Output fluctuations will occur when appliances are connected to and disconnected from the generator.

**Important:** Draper Tools recommends that voltage and surge protectors are used for all sensitive equipment, including laptops, televisions and stereo equipment. This also includes caravans where electronic equipment is incorporated as part of the wiring.

- Switch off connected appliances before disconnecting them from the generator or switching the generator off.
- Switch the AC circuit breaker to the '**OFF**' (O) position before connecting and disconnecting external appliances.
- If an appliance exhibits unusual behaviour, switch off the generator immediately and examine the appliance for signs of malfunction.

### 8.4 Using the DC Outlet

- The 12V DC outlet can be used to top up wet lead-acid batteries **ONLY**.

**Important:** These instructions are intended as a guide **ONLY**. **ALWAYS** refer to the vehicle and battery manufacturer manuals for specific instructions relating to the vehicle to be charged as the procedure varies between batteries. Any manufacturer

instructions relating to other equipment to be used in the immediate area should also be consulted. Read all instructions in full **BEFORE** charging a lead-acid battery using this product.

**Important:** It is recommended that no other appliances are plugged into this product while it is being used to charge a lead-acid battery.

- If the vehicle battery is not a maintenance-free or sealed battery:
  - Remove the cell filler caps and check the level of electrolyte.
  - If necessary, top up the electrolyte to the manufacturer's recommended level using distilled or deionised water.



**CAUTION! Top up with distilled or deionised water ONLY. NEVER top up lead-acid batteries with tap water.**



**WARNING! Battery fluid is corrosive. DO NOT touch the battery fluid or overfill the cells.**

- Check the electrolyte density (specific gravity) using a hydrometer (not supplied) to ensure that the acid to water ratio is sufficient.
1. Clean the battery terminals with a dry cloth to optimise conduction with the terminal clamps.

**Important:** **ALWAYS** wear protective gloves when handling battery terminals.
  2. Measure the battery voltage for indications of deep discharge using a Multimeter (not supplied) or a similar tool.

**Important:** Deep discharge constitutes discharging the battery to 20% or less of its full charge capacity and can cause significant damage to batteries not intended for use in this way. **DO NOT** attempt to charge a deep-discharged battery using this product.

3. Refer to the vehicle and battery manufacturer instructions for guidance on connecting the 12V DC cable clamps to the battery terminals and charging. Most vehicles require the positive (red) clamp to be connected before the negative (black) clamp; **ALWAYS** follow the manufacturer instructions.



**WARNING! If the terminals are connected using the incorrect polarity, disconnect them IMMEDIATELY to avoid damaging the battery.**

4. Insert the charging lead plug into the generator's 12V DC outlet (7) to begin charging. Monitor the voltage across the battery regularly during charging and disconnect the battery when the voltage reaches 12.4V.

**Important:** In most cases, the negative (black) cable should be disconnected from the battery first, then the positive (red) cable.

## 8.5 Circuit Breakers

- Both the AC and DC outlets are equipped with distinct circuit breakers that are activated when the load current becomes too high. When tripped, the circuit breakers cut power to the corresponding outlet.
- The DC circuit breaker (8) pops out from the unit when tripped and is stiff to the touch. It can be reset by allowing the generator to rest for a few minutes and then pressing the circuit breaker back into the unit.
- The AC circuit breaker (4) switches to the '**OFF**' position when tripped and is reset by allowing the unit to rest for a few minutes and then moving the circuit breaker back to the '**ON**' position.
- A likely cause of the safety switch activation is substantial overloading or poor condition of the external appliances. While marginal overloading may not trip the safety switch, it may still shorten the life of the product.
- If a circuit breaker is tripped:
  - Switch off and disconnect all connected appliances then switch off the generator.
  - Reset the circuit breaker in the usual way.
  - Restart the generator normally.
  - Gradually reintroduce the external appliances, ensuring that the load is at a lower level than the point when the switches were tripped.
- If the circuit breaker does not reset after disconnecting the appliances and restarting the generator, contact Draper Tools for support. **DO NOT** continue to use the generator until the issue is rectified.

## 8.6 Automatic Voltage Regulator (AVR)

This generator is equipped with AVR technology, which provides automatic voltage regulated power to ensure a continuous, uninterrupted and stable power supply.

The AVR maintains a regulated AC output and reacts substantially more quickly to rapid surges in voltage, reducing the likelihood of damage to the generator or connected equipment.

**Important:** It is recommended that any sensitive connected equipment is also protected by appropriate surge protection equipment.

# 9. Maintenance and Troubleshooting

**Important:** Maintenance and repairs should be carried out **ONLY** by authorised and suitably qualified personnel.



**WARNING! ALWAYS turn off the engine and allow it to cool before maintaining or storing this product. If the engine must be run for testing, ensure that this is carried out in a well-ventilated environment that allows carbon monoxide from the exhaust to dissipate quickly.**

For optimal performance and a longer lifespan, maintain the generator according to the schedule outlined in this section. If the generator is used in abnormally hot or dusty environments, increase the frequency of each aspect of the maintenance schedule.

## 9.1 General Maintenance

- Keep all air vents clean and free from obstructions at all times.
- Clean the machine with a damp cloth **ONLY**.  
**Important: DO NOT** use solvents as this may damage any plastic or uninsulated parts.
- Use **ONLY** spare parts recommended by Draper Tools.

## 9.2 Draining the Fuel

**Important:** Fuel should be stored in the tank for no more than four weeks. Draper Tools recommends draining the fuel from the generator before storage, particularly if the machine will be stored for long periods. After draining the fuel tank, always run the engine until the last of the fuel in the system is spent and drain the float bowl when the engine is cool.

**Important:** Read all the Health and Safety guidance for the use of petrol as a fuel before filling or draining this product.



**WARNING! NEVER drain the fuel tank indoors.**

**To drain the fuel:**

1. Turn the fuel tap (15) to the closed position.
2. Use a siphon (not supplied) to extract the fuel into a suitable container.
3. Identify the fuel line connected to the tap and detach it.  
**Important:** The fuel line may leak when detached. Catch any discharged fuel in a suitable container.
4. Position a funnel (not supplied) to direct the fuel into a suitable container.

5. Open the fuel tap and allow the remaining fuel to drain from the fuel tank.
6. When the fuel is drained, close the fuel tap.
7. Loosen the float bowl drain bolt and allow the fuel to drain into a suitable container.
8. Move the fuel tap to the open position and allow the fuel to drain from the tank.
9. When the fuel has drained, tighten the float bowl drain bolt and wipe up any spillages.
10. Start the engine and allow it to run until it exhausts the residual fuel in the system.

**Important: ALWAYS** dispose of waste fuel responsibly and in accordance with local regulations.

## 9.3 Draining the Engine Oil

**Important:** The engine oil level and condition should be inspected before every use and replaced every three months or after 50 hours of use. It should additionally be replaced after the first month or 20 hours of use, and if it becomes contaminated with water or debris.

Drain the oil before the engine has completely cooled to allow faster and more thorough drainage.



**WARNING! ALWAYS wear protective gloves when draining the oil as the oil and reservoir will be hot.**

1. Position the generator on level ground and start the engine normally.
2. Allow a few minutes for the engine to warm up, then switch off the generator.
3. Remove the oil filler cap.



**WARNING! Be mindful of hot vapours escaping from the oil reservoir when the filler cap is removed.**

4. Open the oil drain bolt (10) and allow the oil to drain into a suitable container.
5. Check the gaskets and clean or replace them as required.
6. Refit the drain bolt, then refill the oil and check the level (see 7.2 Checking and Topping Up the Engine Oil).
7. Tighten the oil filler cap securely in place.

**Important: ALWAYS** dispose of waste oil responsibly and in accordance with local regulations.

## 9.4 Air Filter Care

Clean the air filter chamber and element at least after every 50 hours of use or every three months to ensure consistent airflow into the carburettor.

Increase the frequency of cleaning when working in dusty environments.



**WARNING! NEVER use petrol or solvents to clean the air filter elements as they may damage the filter or result in a fire when the machine is next used.**



**CAUTION! NEVER run the machine without the air filter elements in place as this may cause the engine to degrade rapidly.**

1. Ensure that the choke lever (16) is in the closed position to prevent any debris from entering the carburettor.
2. Open the air filter (14) cover.
3. Remove the filter element and inspect it for holes, tears and obstructions.

**Important:** If the foam element is damaged, replace it with a new one. **DO NOT** use the machine if the air filter is damaged.

4. Wash the element in warm soapy water and allow it to dry thoroughly.

**Important:** **DO NOT** use solvents to clean the element.

5. Clean the compartment and covers of any dust, dirt or other obstructions.
6. Reassemble the air filter and fix the cover securely in place, ensuring it is correctly seated in the housing.

## 9.5 Spark Plug Care

Ensure that the spark plug is clean and correctly gapped. The spark plug may become contaminated over time if the machine is run with part-throttle for prolonged periods.

**Important:** Replace the spark plug after every 50 hours of use or every three months.

1. Remove the spark plug cover (23).

**Important:** **DO NOT** use tools to remove the cover as they may damage the HT lead.

2. Use the assembled spanner (29) to remove the spark plug.
3. Visually inspect the spark plug and replace it if the ceramic insulator is cracked or chipped.

4. Measure the spark plug gap using a feeler gauge (not supplied) and correct as appropriate by gently bending the electrode into position.

**Important:** The gap should be **0.7–0.8mm**.

5. Screw the spark plug into place using 20Nm (2mkg, 14ftlb) of torque and replace the spark plug cover securely.



**CAUTION! The spark plug MUST be correctly tightened. Loose spark plugs can become very hot and cause damage to the engine. NEVER use a spark plug with a heat range that is not appropriate for the machine in which it is used.**

## 9.6 Fuel Filter Care

The fuel filter (20.1) sits inside the fuel tank opening and ensures that the fuel remains clean. It must be checked regularly and replaced when it becomes clogged.

**Important:** Wear protective gloves to protect your hands from the fuel.

1. Disconnect the spark plug cover (23).
2. Drain the fuel from the tank; see section **9.2 Draining the Fuel**.
3. Remove the fuel tank cap (21) and extract the fuel filter.
4. Inspect the filter for damage and clean or replace it as necessary:
  - Thoroughly clean the filter using warm soapy water and allow it to dry completely.
  - Important:** **DO NOT** use solvents to clean the filter.
  - Replace the filter if it is damaged or clogged.
5. Insert the fuel filter back into the opening and replace the fuel tank cap securely.

# 9. Maintenance and Troubleshooting

## 9.7 Maintenance Schedule

REGULAR SERVICE PERIOD		Before each use	First month or 20hrs	Every 3 months or 50hrs	Every 6 months or 100hrs	Every 1 year or 300hrs
ITEM Perform at every indicated month or operating hour interval, whichever comes first. Replace if necessary.						
Spark plug	Check or Replace			●		
Engine oil	Check Oil level	●				
	Replace		●		●	
Air Filter	Check or Replace			●		
Fuel Filter	Clean or Replace				●	
Valve clearance	Check or Adjust					●
Fuel line	Check or Replace	●				
Exhaust System	Check or Replace Gasket	●				
	Check Muffler screen				●	
Carburettor	Check choke operation	●				
Starting System	Check key start ignition	●				
Decarbonisation	Frequently if necessary					●
Fittings/fasteners	Check/Correct				●	

For guidance relating to any of the listed procedures, contact the Draper Helpline; details can be found on the back page of this manual.

## 9.8 Storing the Product

**Important: ALWAYS** ensure that the engine has completely cooled before storing the machine.

- Prepare the machine correctly for storage:
  - Ensure that the engine power switch is in the **'OFF' (O)** position.
  - Disconnect the spark plug cover (20).
  - Drain the fuel from the tank and carburettor.
  - Tighten all reservoir caps and leakage points.
  - Cover the machine with a plastic sheet to protect it against dust and moisture.
- Store the generator in a dry and dust-free environment, out of reach of children.
- Store the machine at a temperature of 0–30°C.
- Start the engine at periodic intervals and allow it to run for several minutes to prevent seizure within the engine.

**If the machine is to be stored for a prolonged period, ensure that the engine cylinder is sufficiently lubricated to prevent it from seizing:**

1. Remove the spark plug; see section **9.5 Spark Plug Care**.
2. Pour a few drops of SAE 15W-40 oil into the socket.
3. Pull the recoil starter (13) slowly to distribute the oil.
4. Return the spark plug securely to the socket.
5. When restarting after storage:
  - a. Remove the spark plug.
  - b. Hold a cloth around the spark plug socket opening. **Important: DO NOT** smother or completely cover the opening.
  - c. Pull on the recoil starter several times and catch any ejected oil using the cloth. Do this until no more oil is ejected from the opening.
  - d. Return the spark plug securely to the socket
  - e. Start the engine in the usual way; see section **8.1 Starting the Generator**.

## 9.9 Troubleshooting

Problem	Possible Cause	Remedy
The engine will not start.	The engine power switch is in the <b>'OFF' (O)</b> position.	Press the engine power switch to the <b>'ON' (I)</b> position.
	The fuel or oil level is too low.	Check and top up the fuel and oil levels as appropriate (see sections <b>7.1</b> and <b>7.2</b> ).
	The fuel tap is closed.	Rotate the fuel tap to the <b>'ON'</b> position.
	The spark plug electrode has been fouled or the gap is set incorrectly.	Clean or replace the spark plug (see section <b>9.5</b> ).
	The spark plug H.T. lead is not connected correctly.	Press the spark plug cover on firmly and ensure that the housing is not interfering with the connection.
	The choke is set incorrectly for the starting conditions.	Ensure that the choke lever is set in the <b>'OPEN'</b> position for a warm start or <b>'CLOSED'</b> for a cold start.
	The air filter is clogged.	Clean or replace the air filter (see section <b>9.4</b> ).
	The fuel filter is clogged.	Clean or replace the fuel filter (see section <b>9.6</b> ).
	A load has been applied before starting the generator.	Disconnect the external appliance and retry.
The engine stutters or runs roughly after starting.	The choke lever is set in the <b>'CLOSED'</b> position.	Move the choke lever to the <b>'OPEN'</b> position and retry.
	Parts of the engine require maintenance.	Clean or replace the air filter, fuel filter and spark plug.
	The fuel has been stored for too long and has deteriorated.	Drain the fuel (see section <b>9.2</b> ) and clean the fuel filter (see section <b>9.6</b> ), then refuel the generator (see section <b>7.1</b> ).
The engine stops automatically during operation.	The fuel level has dropped too low.	Check and top up the fuel tank (see <b>7.1</b> ).
	The load exceeds the rated capacity of the generator.	Check the rating plates of all connected appliances and reduce the load on the generator as appropriate.
The engine runs with low power.	Parts of the engine require maintenance.	Clean or replace the air filter, fuel filter and spark plug (see <b>9.4</b> , <b>9.5</b> and <b>9.6</b> ).
	The choke is <b>'CLOSED'</b> .	Move the choke to the <b>'OPEN'</b> position after the engine has run for a few seconds.
The generator is leaking oil.	An O-ring seal is damaged or failing.	Replace the faulty part; contact Draper Tools for support.
	There are loose bolts in the engine.	Tighten all bolts and fittings.
There is no electrical output.	Circuit breakers activated.	Switch off and disconnect the devices and reset circuit breaker. Then switch off the generator. Retry after a few minutes.
	The receptacle is faulty.	Contact Draper Tools for support.
	The motor brushes are worn.	Contact Draper Tools for support.
The generator overheats.	The generator is overloaded.	Reduce the load and retry.
	The generator is not sufficiently ventilated.	Move the generator to a location with increased ventilation.

# 10. Associated Risks and Preventative Measures

## 10.1 Risk of Electrocutation and Fire

Hazard	What could happen	How to prevent it
Improper positioning of the power cords of connected appliances.	Power cords can come into contact with hot parts of the engine and be damaged. Passing current through a damaged power cord can result in electrocution or death.	Reposition power cords so that they do not pass within close proximity to the engine and heated parts of the generator.
Operation of the generator in rain or wet, icy or flooded environments.	Water that comes into contact with electrically charged components can transmit electricity to the frame and other surfaces, resulting in electrocution.	Operate the product in a clean, dry and well-ventilated area. Ensure your hands are dry before touching the unit.
Placement of the generator on or against highly conductive surfaces, such as a steel walkway or a metal roof.	Accidental leakage of electrical current could charge conductive surfaces in contact with the generator.	Place the generator on a low-conductivity surface, such as a concrete slab.  Always operate the generator at a minimum of 2m from any conductive surface.
Operation of the generator when it is damaged or when guards or panels have been removed.	Attempting to use the unit when it has been damaged or when it is not functioning normally could result in fire or electrocution.  Removal of guards or panelling could expose electrically charged components and result in electrocution.	Do not operate the generator if it exhibits mechanical or electrical problems. Have the product repaired by an authorised service agent.  Do not operate the generator if any of the protective guarding has been removed.

## 10.2 Risk of Fire

Hazard	What could happen	How to prevent it
Attempting to fill the fuel tank while the engine is running.	Fuel and fuel vapours can ignite if they come into contact with hot components such as the muffler, exhaust gases or an electrical spark.	Turn the engine off and allow it to cool completely before adding fuel to the tank. Ensure that a fire extinguisher suitable for petrol fires is located within the working area.
Sparks, fire and hot objects.	Cigarettes, sparks, fires and other hot objects can cause fuel or fuel vapours to ignite.	Add fuel to the tank in a well-ventilated area. Always ensure that sources of heat and ignition are kept well away from the generator.
Improper storage of fuel.	Fuel stored improperly may result in accidental ignition or may be accessible to children and unauthorised personnel.	Store fuel in an approved container designed to hold fuel, and in a secure location away from flammable materials and sources of heat and ignition.

# 10. Associated Risks and Preventative Measures

## 10.2 Risk of Fire (Continued)

Hazard	What could happen	How to prevent it
Tampering with the factory-set engine speed settings.	The engine speed has been set at the factory to provide safe operation of the machine. Tampering with the engine speed adjustment could result in the appliances overheating and cause a fire.	Never attempt to speed up the engine to improve performance. This will impact both the output voltage and output frequency and endanger any connected appliances, as well as the user.
Inadequate ventilation of the generator.	Materials placed on, against or near to the generator, or operation of the generator in areas where the ambient temperature exceeds 40°C, may interfere with the proper ventilation of the machine and cause overheating, which may result in the ignition of those materials.	Operate the generator in a clean, dry and well-ventilated area. Do not operate the generator indoors or in any confined area. Never cover or place objects onto the generator.
Overfilling of the fuel tank.	Spilled fuel and its vapours can ignite if it comes in contact with hot surfaces or sparks.	Exercise extreme caution when filling the fuel tank to avoid spillages. Ensure that the fuel tank cap is securely tightened and check the engine for fuel leaks before switching on the machine. Allow for fuel expansion. Never refuel with the engine running.

## 10.3 Risk of Injury and Property Damage When Transporting the Generator

Hazard	What could happen	How to prevent it
Fire, inhalation and damage to vehicle surfaces.	Fuel and oil can leak or spill and may result in a fire or breathing hazard and cause serious injury or death. Fuel and oil leaks can damage carpet, paint and other surfaces in vehicles and trailers.	Ensure that the fuel tap is set to the closed position before transporting the generator to avoid fuel leaks. Transport fuel only in a suitable container designed for that purpose. Always place the generator on a protective mat when transporting to protect vehicles from damage caused by leaks. Remove the generator from the vehicle immediately upon arrival at the destination.

## 10.4 Risk of Inhalation of Toxic Substances

Hazard	What could happen	How to prevent it
Petrol engines produce toxic carbon monoxide exhaust fumes.	Breathing exhaust fumes may cause serious injury or death.	Operate the generator in a clean, dry and well-ventilated area. Never operate the machine in enclosed areas such as garages, basements and sheds, or in any location inhabited by humans or animals. Keep children, pets and unauthorised personnel away from the machine at all times.

# 10. Associated Risks and Preventative Measures

---

## 10.5 Risk of Unsafe Operation

Hazard	What could happen	How to prevent it
Operation of the generator in a careless manner.	All sources of energy carry the potential for injury. Unsafe operation or maintenance of the generator may lead to serious injury or death to you or others.	Review and understand all of the safety and operation instructions in this manual.  Become familiar with the operation and controls of this machine, particularly how to switch it off quickly.  Ensure that a fire extinguisher suitable for petrol fires is located within the working area.  Keep children, pets and unauthorised personnel away from the machine at all times.
Operation of the generator in a suspended or uneven position.	The generator will not operate properly and may become damaged if it is not oriented correctly and may cause serious injury if it is not stable or secure.	Never operate the generator in a suspended or uneven position. Always place it on a flat, level and stable surface.

---

## 10.6 Risk of Hot Surfaces

Hazard	What could happen	How to prevent it
Contact with hot parts of the engine and other components.	Contact with hot surfaces, such as the engine exhaust components, may result in serious burns.	During operation, handle only the dedicated control and gripping surfaces of the generator. Keep children, pets and unauthorised personnel away from the generator at all times as they may be unable to identify the hazardous areas of the product.

---

## 10.7 Risk of Injury from Moving Parts

Hazard	What could happen	How to prevent it
Contact with moving parts may result in serious injury.	The generator contains parts which rotate at high speed during operation.	These parts are covered by a guard to prevent injury. Never operate the generator without this complete guard in place. Avoid wearing loose-fitting clothing and jewellery that could become caught in moving parts.

---

## 10.8 Risk of Injury During Lifting

Hazard	What could happen	How to prevent it
The generator is very heavy.	Attempting to lift an item unsafely or that is too heavy for your capability may result in serious injury.	When lifting, always keep the object near the vertical axis of your body. Do not use your back to lift heavy loads. This product should be carried by two people.  Both people should crouch down, bending at the knees, and grip the underside of the unit. Using your legs to bear the weight, keep the item as close to your body's centre of gravity as possible. Avoid twisting your body when carrying the unit and instead turn your whole body using your feet.

---

# 11. Spares, Returns and Disposal

For spare parts, servicing, and repair and replacement options, please contact the Draper Tools Product Helpline for details of your nearest authorised agent.

Draper Tools will endeavour to hold any spare parts, if applicable, for seven years from the date that it sells the final matching stock item.

Any servicing or repairs carried out by unauthorised personnel or installation of spare parts not supplied by Draper Tools will invalidate your warranty.

**Important:** For safety, **ALWAYS** drain and clean the product of any oil, fuel, chemicals or other substances before returning it to Draper Tools or its authorised agent. Store these materials in suitable containers and dispose of them in accordance with local regulations. Draper Tools and its agents cannot be responsible for the disposal of these substances.

At the end of its working life, dispose of the product responsibly and in line with local regulations. Recycle where possible.

- **DO NOT** dispose of this product with domestic waste; most local authorities provide appropriate recycling facilities.
- **DO NOT** burn or mutilate this product; this may release toxic or corrosive substances
- Dispose of oil and fuel separately and in accordance with local regulations; **DO NOT** abandon them in the environment.



# 12. Warranty

12 months date of purchase –  
Visit [drapertools.com/warranty](http://drapertools.com/warranty) for more information.

However, if the tools are hired out, the warranty period is 90 days from the date of purchase.

**Draper Tools Limited**

# 13. Explanation of Symbols EN



Read the instruction manual.



Wear ear defenders.



**DO NOT** abandon into the environment.



Keep out of the reach of children.



**Warning!**



**Warning!** Flammable material.



**Warning!** Very hot surfaces.



**Warning!** Risk of electrocution.



**Warning!** Risk of toxic fumes.



**DO NOT** operate the machine indoors.



**DO NOT** connect to socket outlets when performing maintenance.



**DO NOT** operate the machine without essential lubricating oil.



Keep your distance.



Must be earthed.



WEEE – Waste Electrical & Electronic Equipment

Do not dispose of this product with domestic waste



Continuous A-Weighted Sound Power Level.  
Single value noise marking (maximum declared A-Weighted sound power level in decibels).



UK Conformity Assessed.



European conformity.

## Contact Details

### **Draper Tools**

Draper Tools Limited  
Hursley Road  
Chandler's Ford  
Eastleigh  
Hampshire  
SO53 1YF  
UK

**Website:** [drapertools.com](http://drapertools.com)

**Email:** [sales@drapertools.com](mailto:sales@drapertools.com)

**Product Helpline:** +44 (0) 23 8049 4344

**Telephone Sales Desk:** +44 (0) 23 8049 4333

**General Enquiries:** +44 (0) 23 8026 6355

### **Draper Tools Europe B.V.**

Oude Graaf 8  
6002 NL  
Weert  
Netherlands

Please contact the Draper Tools Product Helpline for repair and servicing enquiries.