

DRAPER

EN

Original Instructions
Version 3
February 2026

GASLESS **MIG WELDER**

63669/70050/70051



Model	MIG WELD 150A	Serial No.	63669/70050/70051
Input	230V AC 50/60Hz	Output	150A
Power	3.5kW	Weight	10kg
Dimensions	150x100x100mm	Warranty	2 Years
CE	EN 60974-1	EN 60974-2	EN 60974-3

Stock No: 70050

**UK
CA** **CE**

1. Preface

These are the original product instructions. This document is part of the product; retain it for the life of the product, passing it on to subsequent holders. Read this manual in full before attempting to assemble, operate or maintain this product.

This Draper Tools manual describes the purpose of the product and contains all the necessary information to ensure its correct and safe use. Following all the instructions and guidance in this manual will ensure the safety of both the product and the operator and increase the lifespan of the product.

All photographs and drawings within this manual are supplied by Draper Tools to help illustrate correct operation of the product.

Every effort has been made to ensure the information contained in this manual is accurate. However, Draper Tools reserves the right to amend this document without prior warning. Always use the latest version of the product manual.

1.1 Product Reference

User Manual for: Gasless Mig Welder

Stock No: 63669/70050/70051

Part No: MIG100/MW150A/SF/MW120A/SF

1.2 Revisions

Version 1: April 2021
First release

Version 2: August 2025

Version 3: February 2026

As our manuals are continually updated, always ensure that the latest version is used.

Please visit drapertools.com/manuals for the latest version of this manual and the associated parts list, if applicable.

1.3 Understanding the Safety Content of This Manual



WARNING! – Situations or actions that may result in personal injury or death.



CAUTION! – Situations or actions that may result in damage to the product or surroundings.

Important: – Information or instructions of particular importance.

1.4 Copyright © Notice

Copyright © Draper Tools Limited.

Permission is granted to reproduce this manual for personal and educational use **ONLY**. Commercial copying, redistribution, hiring or lending is strictly prohibited.

No part of this manual may be stored in a retrieval system or transmitted in any other form or means without written permission from Draper Tools Limited.

In all cases, this copyright notice must remain intact.

1. Preface	2
1.1 Product Reference	2
1.2 Revisions	2
1.3 Understanding the Safety Content of This Manual	2
1.4 Copyright © Notice	2
2. Contents	3
3. Product Introduction	4
3.1 Intended Use	4
3.2 Specification	4
4. Health and Safety Information	5-7
4.1 General Health and Safety Precautions	5
5. Identification and Unpacking	8
5.1 Product Overview	8
6. Assembly Instructions	9
6.1 Assembling the Welder	9
7. Setting the Welder	10
7.1 General	10
7.2 Location	10
7.3 Installing The Filler Wire	10
8. Operating Instructions	11-12
8.1 Basic Welding Operation	10
8.2 On/Off Switch	10
8.3 Welding Current Regulation Switches	10
8.4 Wire Speed Adjustment	11
8.5 Thermal Cut Out	11
8.6 Mig Welding Principles	12
8.7 Definition	12
9. Troubleshooting	13
9.1 Troubleshooting Guide	13
9.2 Maintenance	13
10. Warranty	14
11. Spares, Returns and Disposal	14
12. Explanation of Symbols	15

3. Product Introduction

3.1 Intended Use

This MIG welder is a limited duty machine designed to perform welding fabrication on a variety of steel types with flux cored filler wire.

Intended for domestic and infrequent light trade use. Any application other than that it was intended for, is considered misuse.

3.2 Specification

Stock No.	63669	70050	70051
Part No.	MIG100	MW150A/SF	MW120A/SF
Rated voltage	230~50Hz	230~50Hz	230~50Hz
Effective Input current	5A	8.8A	7.3A
Current range	40 - 100A	80 - 150A	50 - 120A
MIG wire range (Flux cored)	0.6 - 0.9mm	0.6 - 0.9mm	0.6 - 0.9mm
MIG Wire Spool	0.45kg	0.45kg	0.45kg
Degree of protection	IP21S	IP21S	IP21S
Cooling	Air (fan)	Air (fan)	Air (fan)
Insulation class	H	H	H
Duty cycle:	10% @ 100A , 60% @40A	10% @ 150A , 60% @80A	10% @ 120A , 60% @50A
Net weight (machine only)	12.0kg	16.5kg	15.5kg

4.1 General Safety Instructions



Warning! Read all safety warnings and all instructions. When using electric tools basic safety precautions should always be followed to reduce the risk of fire, electric shock, and personal injury including the following.

Read all these instructions before attempting to operate this product and save these instructions.

Important: This product is not a toy and must not be used by children or any person with reduced physical, sensory or mental capabilities or lack of experience and knowledge, or people unfamiliar with these instructions.

Local regulations may restrict the age of the operator.

Electric shock can kill:

- Unplug from the socket before carrying out adjustment, servicing, or maintenance.
- Allow 5 minutes waiting time for the capacitors to discharge before removing the panels for any maintenance operations
- **DO NOT** touch live electrical parts.
- **NEVER** use electrode holders or cables with damaged or deteriorated insulation.
- Keep the working environment, equipment, cables, and clothing free from grease, oil, moisture, and dirt.
- Ensure the welding machine has been correctly earthed and all panels are fitted securely.
- The operator must be insulated from the floor and workbench using a dry insulation mat.
- Wear isolating footwear and gloves that are in good condition, i.e. without holes.
- In hazardous conditions of increased electric shock always ensure a second person is present in case of an accident.
- **NEVER** change electrodes with bare hands or damp gloves (for ARC/MMA welders).
- Keep welding cables away from power cables.
- Regularly inspect the condition of the welding, earth, and power cables for signs of damage.
- **DO NOT** leave the machine unattended and unplug from the socket when not in use.
- **DO NOT** use welding cables unsuitable for the amperage.

- Ensure the earth clamp is adjacent to the weld seam, secured to bare metal and when not in use is insulated for safety.
- Keep all equipment well maintained.
- The operator shall prevent gas cylinders in the vicinity of the workpiece from becoming part of the welding circuit.

Fumes & Gases can be harmful:

- The welding process generates hazardous fumes as a by-product. Inhalation of these fumes is hazardous to health.
- Keep your head away from the weld to avoid breathing the fumes.
- If welding in confined spaces ensure adequate ventilation and use a fume extractor.
- Welding fumes displace oxygen. There is a danger of suffocation.
- By-products of welding can react with other chemical vapours to produce a toxic/explosive environment.

Welding can cause fire or explosion:

- Arc welding and allied processes can cause fire and explosions and precautions shall be taken to prevent these hazards.
- Before starting a weld ensure the area is clear of flammable materials.
- Remove any inflammables to a safe distance, especially substances likely to generate a dangerous vapour.
- The welding arc can cause serious burns. Avoid contact with skin.
- Sparks and molten metal are cast out during welding. Take precautions to prevent fire igniting and wear protective clothing.
- Sparks and molten metal can pass through gaps. Be aware that fire can start out of sight. Flammables in a locked cabinet may not be safe.
- **DO NOT** weld pressurised containers.
- **DO NOT** weld tanks, drums, or other vessels until they have been correctly cleaned/prepared for welding.
- **ALWAYS** have appropriate and fully maintained fire-fighting equipment suitable for the materials used and for use in electrical environments available in close proximity at all times.
- Keep clothing free from oil and grease.

- Wear a hat, flame-proof apron, woollen clothing, gloves, long sleeve tops with closed neck, trousers (without turn-ups) to cover non-slip boots.
- Protective head and shoulder coverings should be worn when overhead welding.
- **AVOID** taking any fuels with you e.g. cigarette lighters or matches.
- Hot spots and their immediate surroundings should be observed until their temperature has dropped to normal.

Personal Protection:

- The body should be protected by suitable clothing.
- The use of neck protection may be necessary against reflected radiation.
- Wear safety glasses when chipping, wire brushing, grinding, or when near cooling welds as metal filings or slag can be thrown up. Fully enclosed goggles are advisable.
- Arc machines generate a magnetic field which is detrimental to pacemaker recipients. Consult your doctor before going near welding equipment/ operations.
- The UV and IR radiation generated by welding is highly damaging to the eye, causing burns. This can also affect the skin. Protect the eyes and face.
- The face and eyes shall be protected by suitable welding shields equipped with appropriate ocular protection filters.
- Where environments are subject to pedestrians and traffic ensure a protective screen is used to avoid accidental arc glare.
- **DO NOT** weld in the vicinity of children or animals and ensure no one is looking before striking up.
- In the welding environment, damaging levels of noise can exist. Wear hearing protection if the process dictates.
- **DO NOT** touch hot equipment or metal. Allow the weld time to cool, use the correct tool and wear protective welding gauntlets.
- Wear flame retardant clothing (leather, wool, etc.).
- Take care when adjusting or maintaining the welder that it has had time to cool sufficiently and is disconnected.

The arc generates

- Ultra-violet radiation (can damage skin and eyes).
 - Visible light (can dazzle eyes and impair vision).
 - Infra-red (heat) radiation (can damage skin and eyes).
- Such radiation can be direct or reflected from surfaces such as bright metals and light coloured objects.

Gas cylinders:

- Gas cylinders should be located or secured so that they cannot be knocked over.
- Shield gas containers can explode if damaged. Take care when handling.
- Ensure gas cylinders are shut-off when not in use and between operations.
- Take care that no build-up of gas is permitted to form in confined areas.
- Cylinders must be in an upright position at all times during use and storage.
- The gas cylinder must never come in contact with the electrode.
- Follow the manufacturer's instructions for handling, storing, and using the gas bottle correctly and safely.
- Use the correct equipment to connect the gas bottle to the welding torch.

Limitations:





- **DO NOT** use for:
 - Operations in severe conditions (e.g. extreme climates, freezer applications, strong magnetic fields, etc).
 - Operations subject to special rules (e.g. potentially explosive atmospheres, mines, etc).
 - Operations that require ingress protection greater than IPX0, e.g. in rain or snow, etc.





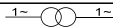

General:







- Training should be sought out in
 - The safe use of this equipment;
 - The processes;
 - The emergency procedures;
- Welding power sources are not to be used for pipe thawing.
- Take precautions against toppling over, if the power source shall be placed on a tilted plane.

4. Health and Safety Information

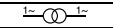
- All equipment should be kept in good working condition, inspected and, when defective, promptly repaired or withdrawn from service - All equipment should be placed so that it does not present a hazard in passageways, on ladders, or stairways, and should be operated in accordance with the manufacturer's instructions.
- In the vicinity of an arc, non-reflective curtains or screens shall be used to isolate persons from the arc radiation. A warning, e.g. a symbol for eye protection, should refer to the hazard of arc radiation.

 Stock No.70050 <small>UK: S053 1YF / EU: DNL3000L</small>		Serial No.:		
		EN 60974-1:2022		
		80A/18V~150A/21.5V		
		X (%)	10	60
		I ₂ (A)	150	80
	U ₀ =40V	U ₂ (V)	21.5	18
 <small>1-50/60Hz</small>	U ₁ =230V	I _{1MAX} =28A	I _{1eff} =8.8A	
IP21S	Class H	Made in China		
				

 Stock No.70051 <small>DTL S053 1YF, UK.</small>		Serial No.:		
		EN 60974-1:2022		
		50A/16.5V~120A/20V		
		X (%)	10	60
		I ₂ (A)	120	50
	U ₀ =33V	U ₂ (V)	20	16.5
 <small>1-50/60Hz</small>	U ₁ =230V	I _{1MAX} =23A	I _{1eff} =7.3A	
IP21S	Class H	Made in China		
				

Stock No.63669 <small>DTL S053 1YF, UK.</small>		Serial No.:		
		EN 60974-1:2022		
		40A/16.1V~100A/19V		
		X(%):	10	60
		I ₂ (A):	100	40
	U ₀ = 28V	U ₂ (V):	19	16.1
 <small>1-50/Hz</small>	U ₁ = 230V	I _{1max} = 13A	I _{1eff} = 5A	
IP21S	Class H			

5. Identification and Unpacking

Carefully remove the product from the packaging and examine it for any sign of damage. If any part is damaged or missing, please contact the Draper Help Line (see back page). Do not attempt to use the product!

The packaging material should be retained during the warranty period, in case the product needs to be returned for repair.

5.1 Product Overview

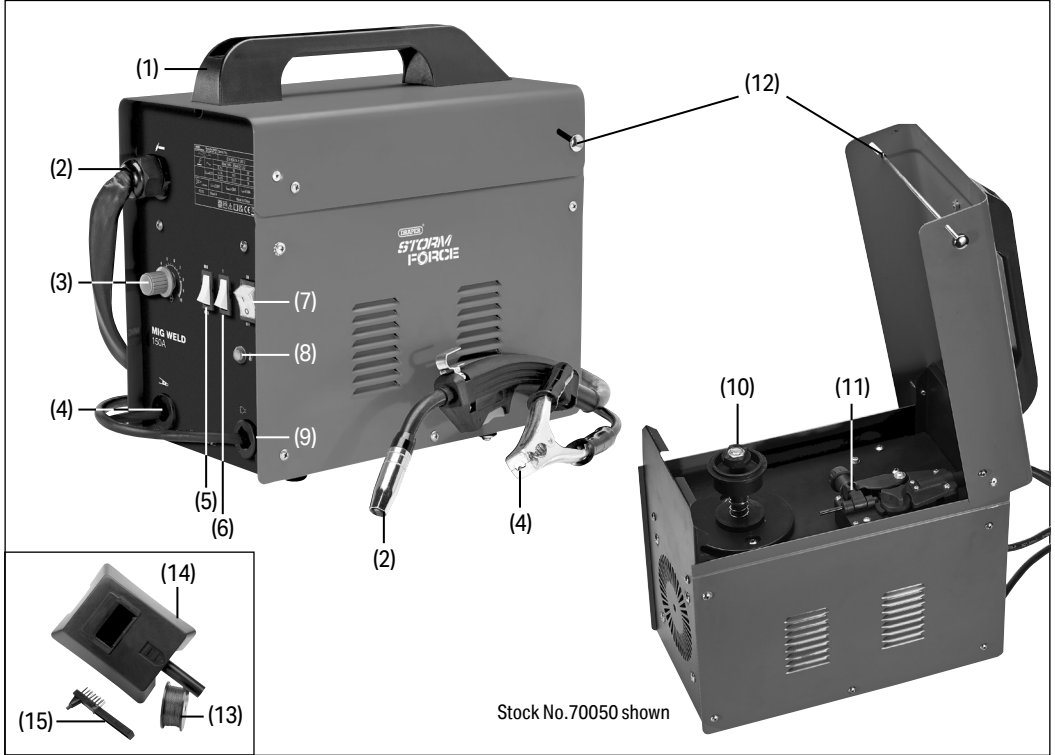

- (1) Transport handle.
- (2) MIG welding torch.
- (3) MIG wire feed speed.
- (4) Earth clamp.
- (5) Max/Min power switch.
- (6) 1, 2 power switch.
- (7) On/Off switch.
- (8) Thermal overload indicator.
- (9) Power cable.
- (10) MIG Spool hub.
- (11) MIG wire feed assembly.
- (12) Open catch.
- (13) Flux cored wire.
- (14) Face mask.
- (15) Hammer/brush.

Please visit drapertools.com for our full range of accessories and consumables.

6.1 Assembling the Welder

Ensure the power supply information on the machine's rating plate is compatible with the power supply you intend to connect it to.

Stock Nos.63669 & 70051.

These appliances are supplied with an approved plug and cable for your safety.

Stock No.70050.

This appliance power wiring has insulation stripped in preparation for wiring a 16A plug (not supplied).

It is designed for connection to a 16amp power supply rated at 230V AC.

A suitable plug must be fitted by a qualified electrician.

Because these appliances are constructed mostly of metal parts, they are Class 1 machines; meaning, they must have an earth connection in the power supply. This is to prevent electrocution in the event of a failure.

Note: Unplug from the socket before carrying out adjustment, servicing or maintenance.

Check that the electrical supply delivers the voltage and frequency corresponding to the welding machine and that it is fitted with a delayed fuse suited to the maximum delivered rated current.

Note: The welding machines are set to the highest voltage at the factory.

7.1 General

This medium weight, portable welder requires no special lifting instructions, however, it contains dedicated circuitry and must be handled with care. The welder is designed to weld with a filler wire feed through the torch (MIG).

7.2 Location

Locate the machine close to the correct power supply and allow a 500mm air gap around to ensure sufficient ventilation. There are two cooling fans located in the rear of the machine housing which must be kept clear. Equally, ensure no debris can be drawn into the machine.

Ensure the location does not pose any hazards as detailed in the safety instructions, before attempting to start the machine.

Note: Refer to the rating label for energy input details.

 **Warning! Unplug from the socket before carrying out adjustment, servicing or maintenance.**

7.3 Installing The Filler Wire (Figs. 1-3)

The welding machine is designed to accept the standard size drums of wire (0.45kg).

The welding wire is flux-cored types this provides a means of shielding the weld pool from the atmosphere.

DO NOT let the filler wire become uncoiled or tangled as this will lead to problems with delivery to the welding torch.

Select the filler wire suitable for the parent metal and with a gauge to match the welder specification.

Note: If the welding machine is not regularly used, remove the wire which is prone to rust and will cause feed problems next time.

1. Open the top panel.
2. Unscrew the large plastic ring. Sit the reel on the hub (10). Refit the large plastic ring.
3. Fit the wire spool so that it feeds off the base of the reel towards the wire drive unit (11).
4. Pull tensioner (11.1) forward off the tension arm (11.2), the tension arm (11.2) will spring up out of the way.
5. The wire must sit in the appropriate groove for the wire gauge. The groove size is etched on the side of the roller. Remove nut to see the groove size that is **NOT** in use. The drive roller (11.4) can be removed from shaft, to change the groove size for appropriate wire gauge. Unscrew and remove the retaining cap.
6. Pass the filler wire through the guide (11.3) and over the top of the drive roller, ensure the wire is well inside the torch liner before closing the arm (11.2) and tensioner (11.1).
7. Press the feed trigger on gun and observe the wire feed mechanism. If the wire is being fed correctly it will come out of the swan neck. If it jams you will need to remove the gas shroud (2.1) and with a small spanner unscrew and remove the tip (2.2). Pass the tip over the wire and secure back onto the swan neck. **DO NOT** over tighten. Resecure the gas shroud and trim the wire back as required.

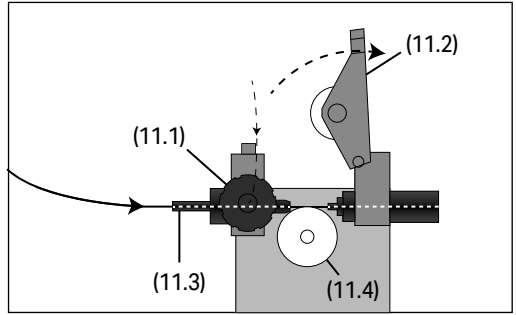

Fig. 1

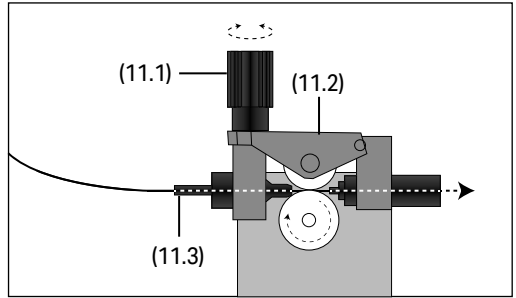

Fig. 2

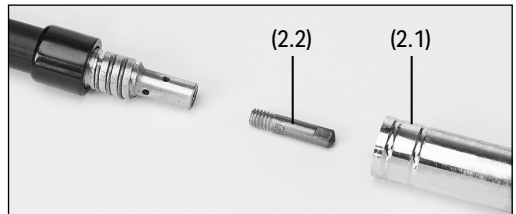

Fig. 3

Note: Ensure the tip size matches the wire size prior to installing.

8.1 Basic Welding Operation

Note: Although this machine is medium weight and portable take care. **DO NOT** manoeuvre over people's heads.

Note: Welding is a mix of science and art and due to the complex principles and vast differences in parameters (ie. Material type, position, condition etc.) That information is well beyond the scope of this manual.

Draper Tools suggest training be obtained from a third party or refer to a suitable reference book on the subject additionally; nothing can beat practice using the welder on scrap material to get a better understanding.

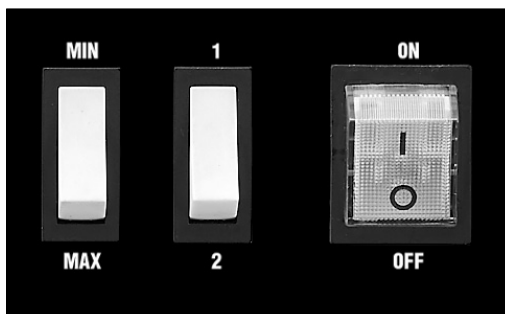

Fig. 4

8.2 On/Off Switch (Fig.4)

The on/off switch is a rocker switch. Press the top half in to switch the welder 'on' and the bottom half in to switch the welder 'off'.

8.3 Welding Current Regulation Switches

The current regulation switches regulate the welders power in four steps:

Min +1, Min +2 and Max +1, Max +2.

Regulate the welding current in conjunction with the wire speed to achieve the optimum arc for the workpiece thickness and type.

8.4 Wire Speed Adjustment (Fig.5)

Wire speed is dependent on material thickness and welding current. Being able to judge the correct wire speed based on the sound and quality of the weld will only come from practice.

- Too fast will result in holes blowing in the weld or the wire hitting the metal will force the torch backward.
- Too slow will result in the wire burning back to the torch into a ball and clogging the tip.

Note: When using the welder on a low amp setting/low wire speed, it is necessary that the wire drive tension is increased on the adjustment to avoid the spool stalling.



Fig. 5

8.5 Thermal Cut Out

If the duty cycle of the welder is exceeded, the thermal cut out will activate to prevent damage to the internal components or further overheating.

When the thermal cut out warning light is lit, the welder must be left to cool down before it can be restarted.

8.6 Mig Welding Principles (Fig.6-7)

The MIG welding process allows two similar materials to be fused together without altering the properties of the material. The electric arc created between the electrode (the welding wire) and the work piece produces the required heat for turning the metal into a molten state. The gas creates a shield around the arc and the molten metal.

The area to be welded and the earth point must be clean of grease, dirt, paint and rust. Clean with a wire brush as necessary. Position the earth clamp as close as possible to the working area and ensure a tight grip is achieved.

Select the welding current based on the thickness of the material. A thick piece will require a high current, however due to the duty cycle this will effect the welding time by significantly reducing it. A thin piece will only require minimal heat and so the current can be less. This will allow a longer period of welding. The position of the torch is critical to the arc and end results.

The position of the welding torch is important to achieve a good quality bead. Position the torch at approximately 35° vertically and 75° horizontally and up to 20mm distance from the join. 20mm is the maximum that can be achieved on the maximum setting. Ensure the gas shroud remains clean of spatter. Likewise and more importantly the wire feed tip must be kept clean to avoid the wire becoming blocked or restricted.

Use of an anti-spatter spray will help keep the end result more tidy.

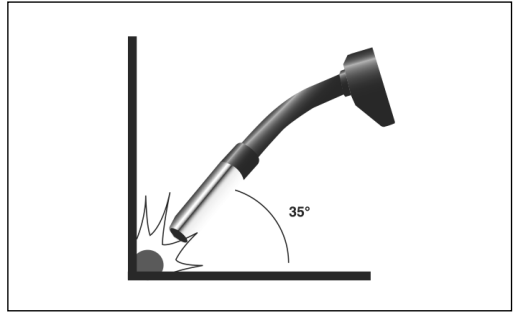

Fig. 6

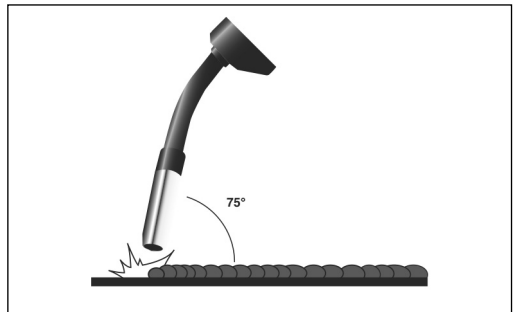



Fig. 7

8.7 Definition

Duty Cycle:



Duty Cycle is a percentage of 10 mins. in which a machine can operate at a rated load without overheating and interruption from the thermal cut-out device.

Example: 150A @ 30% Duty factor

  150A welding for 3 minutes

  7 minutes down time

Example: 95A @ 100% Duty factor

  95A continuous welding

To increase the operation time, reduce the amperage.

Note: The heating tests have been carried out at ambient temperature and the duty cycle (duty factor) at 20°C has been determined by simulation.

Definition:

METAL INERT-GAS (MIG welding)

Also known as **GMAW** (Gas metal arc welding)

A welding process in which an electric arc forms between a consumable wire electrode and the workpiece metal(s), which heats the workpiece metal(s), causing them to melt, and join. Along with the wire electrode, a shielding gas feeds through the welding gun, which shields the process from contaminants in the air.

9. Troubleshooting

9.1 Troubleshooting Guide

 **WARNING!** For your own safety, switch off and unplug from the power supply before carrying out any maintenance.

Problem	Possible Cause	Remedy
Wire not feeding despite wire feed pulley turning	Dirty current nozzle (contact tip)	Clean
	Wire feed pulley set too tight	Loosen
	Too low clamping pressure of the wire feed pulley	Increase the clamping pressure
Interrupted or disruptive wire supply	Damaged current nozzle	Replace
	Burnt current nozzle	Replace
	Dirty driving gear torch liner	Clean
	Cut on worn driving gear	Replace
Electric arc turned off	Poor contact between earth clamp and part to be welded	Tighten the pliers and check them, remove paint and rust
	Short circuit between current nozzle and gas supply pipe	Clean or replace the current and gas nozzle, remove dirt, paint and rust
	Too loose current nozzle	Tighten the current nozzle firmly
Welder suddenly stops working after longer operation	Welder has overheated due to too long use and the thermal protection has activated	Let the welder cool down

IMPORTANT: Please note all repairs/service should be carried out by a qualified person.

9.2 Maintenance

Regular inspection and cleaning reduces the necessity for maintenance operations and will keep your tool in good working condition.

 **Warning: Unplug from the power supply. Periodically the welder must be checked as detailed below.**

- Check the torch cable and ground cable connections.
- Clean the contact tip and the gas shroud with an iron brush. Replace if worn.
- Clean the outside of the welder with a damp cloth.
- Every time the wire spool is replaced:
- Check the alignment, cleanliness and state of wear of the wire roll.
- Remove any metal powder deposited on the wire feeder mechanism and then dry with compressed air.

- Occasionally test to ensure the thermal cut-out device is operating correctly, i.e. weld for an extended period or on a maximum duty cycle.
- Check the condition of the warning labels.
- Replace any worn parts.
- If the power supply cord is damaged, it must be replaced by Draper Tools, an authorised service agent or similarly qualified personnel in order to avoid a hazard.

The welder must be correctly ventilated during operation. Avoid blocking the air inlets and vacuum the ventilation slots regularly.

DO NOT use solvents or fuels to clean the product. When not in use, store the product in a safe, dry place.

Draper Tools products are carefully tested and inspected before shipment and are guaranteed to be free from defective materials and workmanship.

Should the tool develop a fault, return the complete tool to your nearest distributor or contact Draper Tools directly. Contact information can be found at the back of this manual.

Proof of purchase must be provided.

If, upon inspection, it is found that the fault occurring is due to defective materials or workmanship, repairs will be carried out free of charge. This warranty period covers parts and labour for 12 months from the date of purchase.

This warranty does not apply to any consumable parts, batteries or normal wear and tear, nor does it cover any damage caused by misuse, careless or unsafe handling, alterations, accidents, or repairs attempted or made by any personnel other than the authorised Draper Tools repair agent.

In all cases, to make a claim for faulty workmanship or materials within the standard warranty period, please contact or return the product to the place of purchase. Proof of purchase may be required.

If the place of purchase is no longer trading or if you experience any difficulties with your warranty, please contact Customer Services with the product details and your proof of purchase. Contact details can be found at the back of this manual.

If the tool is not covered by the terms of this warranty, repairs and carriage charges will be quoted and charged accordingly.

This warranty supersedes any other guarantees expressed or implied and variations of its terms are not authorised.

Your Draper Tools guarantee is not effective until you can produce, upon request, a dated receipt or invoice to verify your purchase within the guarantee period.

Please note that this warranty is an additional benefit and does not affect your statutory rights.

Draper Tools Limited

11. Spares, Returns and Disposal

At the end of its working life, dispose of the product responsibly and in line with local regulations. Recycle where possible.

- **DO NOT** dispose of this product with domestic waste; most local authorities provide appropriate recycling facilities.



12. Explanation of Symbols



Read the instruction manual



Warning! Wear suitable welding eye/face protection.



Wear ear defenders



Wear protective gloves



Do not abandon in the environment



Keep out of the reach of children



Warning!



Danger of electric shock



Danger of fire



Danger of explosion



Danger of fumes



Danger of ultraviolet radiation



Danger of burning splashes



Pressure bottle to be secured by chain



Fan cooled



Power supply plug



Input voltage



Protection rating



Thermal overload



Mig range



MIG welding (Metal Inert Gas) or GMAW (Gas Metal Arc Welding)



MIG flux cored wire sizes



Machine weight



WEEE – Waste Electrical & Electronic Equipment
Do not dispose of Waste Electrical & Electronic Equipment in with domestic rubbish



Do not incinerate or throw onto fire



For indoor use only;
do not expose to rain



Class 1 appliance (Must be earthed)



European conformity



UK Conformity Assessed

Contact Details

Draper Tools

Draper Tools Limited
Hursley Road
Chandler's Ford
Eastleigh
Hampshire
SO53 1YF
UK

Website: drapertools.com

Email: sales@drapertools.com

Product Helpline: +44 (0) 23 8049 4344

Telephone Sales Desk: +44 (0) 23 8049 4333

General Enquiries: +44 (0) 23 8026 6355

Draper Tools Europe B.V.

Oude Graaf 8
6002 NL
Weert
Netherlands

Please contact the Draper Tools Product Helpline for repair and servicing enquiries.