



DRAPER[®]

12V BATTERY STARTER/CHARGER

53171



These instructions accompanying the product are the original instructions. This document is part of the product, keep it for the life of the product passing it on to any subsequent holder of the product. Read all these instructions before assembling, operating or maintaining this product.

This manual has been compiled by Draper Tools describing the purpose for which the product has been designed, and contains all the necessary information to ensure its correct and safe use. By following all the general safety instructions contained in this manual, it will ensure both product and operator safety, together with longer life of the product itself.

All photographs and drawings in this manual are supplied by Draper Tools to help illustrate the operation of the product.

Whilst every effort has been made to ensure the accuracy of information contained in this manual, the Draper Tools policy of continuous improvement determines the right to make modifications without prior warning.

1. TITLE PAGE

1.1 INTRODUCTION:

USER MANUAL FOR: 30A 12V Battery starter/charger.

Stock No: 53171

Part No: BCMCS70

1.2 REVISIONS:

Date first published July 2020.

As our user manuals are continually updated, users should make sure that they use the very latest version.

Downloads are available from: <http://drapertools.com/manuals>

Draper Tools Limited
Hursley Road
Chandler's Ford
Eastleigh
Hampshire
SO53 1YF
UK

Website: drapertools.com

Product Help Line: +44 (0) 23 8049 4344

General Fax: +44 (0) 23 8026 0784

1.3 UNDERSTANDING THIS MANUALS SAFETY CONTENT:

Warning! – Information that draws attention to the risk of injury or death.

Important – Information that draws attention to the risk of damage to the product or surroundings.

1.4 COPYRIGHT © NOTICE:

Copyright © Draper Tools Limited.

Permission is granted to reproduce this publication for personal and educational use only.

Commercial copying, redistribution, hiring or lending is prohibited.

No part of this publication may be stored in a retrieval system or transmitted in any other form or means without written permission from Draper Tools Limited.

In all cases this copyright notice must remain intact.

2. CONTENTS

2.1 TABLE OF CONTENTS

1. TITLE PAGE	
1.1 INTRODUCTION:.....	2
1.2 REVISIONS:.....	2
1.3 UNDERSTANDING THIS MANUALS SAFETY CONTENT:.....	2
1.4 COPYRIGHT © NOTICE:.....	2
2. CONTENTS	
2.1 TABLE OF CONTENTS	3
3. WARRANTY	
3.1 WARRANTY.....	4
4. INTRODUCTION	
4.1 SCOPE.....	5
4.2 SPECIFICATION.....	5
4.3 HANDLING AND STORAGE.....	5
5. HEALTH AND SAFETY INFORMATION	
5.1 GENERAL SAFETY INSTRUCTIONS FOR POWER TOOL USE	6
5.2 ADDITIONAL SAFETY INSTRUCTIONS FOR BATTERY CHARGERS.....	7
5.3 CONNECTION TO THE POWER SUPPLY.....	8
5.4 RESIDUAL RISK.....	9
6. TECHNICAL DESCRIPTION	
6.1 IDENTIFICATION.....	10
7. UNPACKING AND CHECKING	
7.1 PACKAGING	11
8. PREPARING THE BATTERY CHARGER	
8.1 BEFORE CHARGING YOUR BATTERY – FIGS.1 – 2.....	12
9. OPERATION	
9.1 CHARGING YOUR BATTERY	13
9.2 RECONDITIONING THE BATTERY	14
9.3 USING THE ENGINE START FUNCTION.....	14
10. MAINTENANCE AND TROUBLESHOOTING	
10.1 MAINTENANCE.....	15
10.2 TROUBLESHOOTING GUIDE.....	15
11. EXPLANATION OF SYMBOLS	
11.1 EXPLANATION OF SYMBOLS.....	16
12. DISPOSAL	
12.1 DISPOSAL	17

3. WARRANTY

3.1 WARRANTY

Draper tools have been carefully tested and inspected before shipment and are guaranteed to be free from defective materials and workmanship.

Should the tool develop a fault, please return the complete tool to your nearest distributor or contact:

Draper Tools Limited, Chandler's Ford, Eastleigh, Hampshire, SO53 1YF. England.

Telephone Sales Desk: +44 (0) 8049 4333 or Product Help Line +44 (0) 23 8049 4344.

A proof of purchase **must** be provided with the tool.

If upon inspection it is found that the fault occurring is due to defective materials or workmanship, repairs will be carried out free of charge. This warranty period covering labour is 12 months from the date of purchase except where tools are hired out when the warranty period is 90 days from the date of purchase. The warranty is extended to 24 months for parts only. This warranty does not apply to any consumable parts, any type of battery or normal wear and tear, nor does it cover any damage caused by misuse, careless or unsafe handling, alterations, accidents, or repairs attempted or made by any personnel other than the authorised Draper warranty repair agent.

Note: If the tool is found not to be within the terms of warranty, repairs and carriage charges will be quoted and made accordingly.

This warranty applies in lieu of any other warranty expressed or implied and variations of its terms are not authorised.

Your Draper warranty is not effective unless you can produce upon request a dated receipt or invoice to verify your proof of purchase within the warranty period.

Please note that this warranty is an additional benefit and does not affect your statutory rights.

Draper Tools Limited.

4. INTRODUCTION

4.1 SCOPE

This manual is intended to give the user an overview of the function and controls of this product to aid its safe and effective use. Any application other than that it was intended for, is considered misuse.

4.2 SPECIFICATION

Stock No.....53171
Part No. BCMCS70
Input supply: 230V-50Hz
Output amperages:..... 12V = 2A, 5A, 10A ,20A ,30A
Engine start: 70Amp
Display:.....LCD
USB outputs: 1.0A or 2.4A
Suitable battery types:STD Pb (Lead acid, wet cell), GEL, AGM, MF
Weight (machine only):..... 2.85kg

4.3 HANDLING AND STORAGE

- Care must be taken when handling this product.
 - Dropping this tool could have an effect on its accuracy and could also result in personal injury. This product is not a toy and must be respected.
- Environmental conditions can have a detrimental effect on this product if neglected.
 - Exposure to damp air can gradually corrode components. If the product is unprotected from dust and debris, components will become clogged.
 - If not cleaned and maintained correctly or regularly, the machine will not perform at its best.

5. HEALTH AND SAFETY INFORMATION

5.1 GENERAL SAFETY INSTRUCTIONS FOR POWER TOOL USE

 **Warning! Read all safety warnings, instructions, illustrations and specifications provided with this power tool.** Failure to follow all instructions listed below may result in electric shock, fire and/or serious injury.

Save all warnings and instructions for future reference.

The term “power tools” in the warnings refers to your mains-operated (corded) power tool or battery-operated (cordless) power tool.

1) Work area safety

- a) **Keep work area clean and well lit.** Cluttered or dark areas invite accidents.
- b) **Do not operate power tools in explosive atmospheres, such as in the presence of flammable liquids, gases or dust.** Power tools create sparks which may ignite the dust or fumes.
- c) **Keep children and bystanders away while operating a power tool.** Distractions can cause you to lose control.

2) Electrical safety

- a) **Power tool plugs must match the outlet. Never modify the plug in any way. Do not use any adapter plugs with earthed (grounded) power tools.** Unmodified plugs and matching outlets will reduce risk of electric shock.
- b) **Avoid body contact with earthed or grounded surfaces, such as pipes, radiators, ranges and refrigerators.** There is an increased risk of electric shock if your body is earthed or grounded.
- c) **Do not expose power tools to rain or wet conditions.** Water entering a power tool will increase the risk of electric shock.
- d) **Do not abuse the cord. Never use the cord for carrying, pulling or unplugging the power tool. Keep cord away from heat, oil, sharp edges or moving parts.** Damaged or entangled cords increase the risk of electric shock.
- e) **When operating a power tool outdoors, use an extension cord suitable for outdoor use.** Use of a cord suitable for outdoor use reduces the risk of electric shock.
- f) **If operating a power tool in a damp location is unavoidable, use a residual current device (RCD) protected supply.** Use of an RCD reduces the risk of electric shock.

3) Personal safety

- a) **Stay alert, watch what you are doing and use common sense when operating a power tool. Do not use a power tool while you are tired or under the influence of drugs, alcohol or medication.** A moment of inattention while operating power tools may result in serious personal injury.
- b) **Use personal protective equipment Always wear eye protection.** Protective equipment such as a dust mask, non-skid safety shoes, hard hat or hearing protection use for appropriate conditions will reduce personal injuries.
- c) **Prevent unintentional starting. Ensure the switch is in the off-position before connecting to power source and/or battery pack, picking up or carrying the tool.** Carrying power tools with your finger on the switch or energising power tools that have the switch on invites accidents.
- d) **Remove any adjusting key or wrench before turning the power tool on.** A wrench or a key left attached to a rotating part of the power tool may result in personal injury.
- e) **Do not overreach. Keep proper footing and balance at all times.** This enables better control of the power tool in unexpected situations.
- f) **Dress properly. Do not wear loose clothing or jewellery. Keep your hair and clothing away from moving parts.** Loose clothes, jewellery or long hair can be caught in moving

5. HEALTH AND SAFETY INFORMATION

parts.

- g) **If devices are provided for the connection of dust extraction and collection facilities, ensure these are connected and properly used.** Use of dust collection can reduce dust-related hazards.
- h) **Do not let familiarity gained from frequent use of tools allow you to become complacent and ignore tool safety principles.** A careless action can cause severe injury within a fraction of a second.

4) Power tool use and care

- a) **Do not force the power tool. Use the correct power tool for your application.** The correct power tool will do the job better and safer at the rate for which it was designed.
- b) **Do not use the power tool if the switch does not turn it on and off.** Any power tool that cannot be controlled with the switch is dangerous and must be repaired.
- c) **Disconnect the plug from the power source and/or remove the battery pack, if detachable, from the power tool before making any adjustments, changing accessories, or storing power tools.** Such preventive safety measures reduce the risk of starting the power tool accidentally.
- d) **Store idle power tools out of the reach of children and do not allow persons unfamiliar with the power tool or these instructions to operate the power tool.** Power tools are dangerous in the hands of untrained users.
- e) **Maintain power tools and accessories. Check for misalignment or binding of moving parts, breakage of parts and any other condition that may affect the power tool's operation. If damaged, have the power tool repaired before use.** Many accidents are caused by poorly maintained power tools.
- f) **Keep cutting tools sharp and clean.** Properly maintained cutting tools with sharp cutting edges are less likely to bind and are easier to control.
- g) **Use the power tool, accessories and tool bits etc. in accordance with these instructions, taking into account the working conditions and the work to be performed.** Use of the power tool for operations different from those intended could result in a hazardous situation.
- h) **Keep handles and grasping surfaces dry, clean and free from oil and grease.** Slippery handles and grasping surfaces do not allow for safe handling and control of the tool in unexpected situations.

5) Service

- a) **Have your power tool serviced by a qualified repair person using only identical replacements parts.** This will ensure that the safety of the power tool is maintained.

5.2 SAFETY INSTRUCTIONS FOR MAINS POWERED CHARGERS & BATTERY PACKS

Chargers

- The charger is for indoor use only.
- This appliance can be used by children aged from 8 years and above and persons with reduced physical, sensory or mental capabilities or lack of experience and knowledge if they have been given supervision or instruction concerning use of the appliance in a safe way and understand the hazards involved. Children shall not play with the appliance. Cleaning and user maintenance shall not be made by children without supervision.
- Prior to plugging the charger in to the supply, check that the plug, cable and charger casing are in good condition. If any are damaged, have the defective part(s) replaced immediately by a suitably qualified person.
- Only use a correctly rated mains outlet to provide power, do not plug into site generators,

5. HEALTH AND SAFETY INFORMATION

attach to engine generators or D.C. sources. Do not use a mains socket outlet that is not switched.

-  **Warning!** Explosive gases. Prevent flames and sparks. During charging, provide adequate ventilation during charging. The battery must be placed in a well ventilated area (for chargers for lead-acid batteries).
- Do not attempt to charge battery packs that are too hot (over 30°C) or too cold (under 5°C), if these conditions apply set the battery pack aside to “normalise” before proceeding with the charging operation.
- Set up the charger and cable in a safe place where it won't be knocked, tripped over, stepped on, etc. and where it is well ventilated. Make sure the ventilation slots in the charger case are not obstructed.
- Inspect the battery pack for damage, if it is undamaged, plug it into the charger, ensuring the correct orientation.
- Switch the charger on and check that the correct indicators illuminate, allow the battery pack to charge (see the specific instructions for your charger). Once charging is complete, switch the charger off, disconnect from power supply, remove the battery pack and store.
- The battery terminal not connected to the chassis has to be connected first. The other connection is to be made to the chassis, remote from the battery and fuel line. The battery charger is then to be connected to the supply mains;
- After charging, disconnect the battery charger from the supply mains. Then remove the chassis connection and then the battery connection.

Battery packs



- Before charging, read the instructions.
- Do not expose to rain.
- The charger must be disconnected from the power supply before removing the battery.
- The battery must be removed from the appliance before it is recycled.
- The battery is to be disposed of in-line with local authority procedures.
- Do not crush, open or burn the battery. Exposure to potentially harmful materials may occur.
- In case of fire use CO₂ or dry chemical extinguisher.
- Do not expose to high temperatures >50°C. The battery may degrade at high temperatures.
- Charge battery in conditions between 5°C to 30°C with the designated charger for the battery.
- Do not use battery if it has been stored at 5°C or less. Allow it to “normalise” at room temperature before usage/charging.

Warning! – Leaking battery packs

- The electrolyte in battery packs is corrosive. Avoid contact with the skin.
- If contact is made, flush the area with clean water, pat dry and seek medical attention at the earliest opportunity.
- Inform medical personnel that the contaminant is a “high alkaline, corrosive liquid”.
- If electrolyte comes into contact with the eyes, flush with copious amounts of water only. Seek immediate medical attention, relaying the information above.

5.3 CONNECTION TO THE POWER SUPPLY (CHARGER)

Caution: Risk of electric shock. Do not open.

This appliance is supplied with an approved plug and cable for your safety. The value of the fuse fitted is marked on the pin face of the plug. Should the fuse need replacing, ensure the substitute is of the correct rating, approved to BS1362 and ASTA  or BSI Kite  marked.

Ensure the fuse cover is replaced before attempting to connect the plug to an electrical outlet. If

5. HEALTH AND SAFETY INFORMATION

the cover is missing, a replacement must be obtained or the plug replaced with a suitable type.

If a replacement plug is to be fitted this must be carried out by a qualified electrician.

Never use a damaged or incomplete plug.

This appliance is Class II[†] and is designed for connection to a power supply matching that detailed on the rating label and compatible with the plug fitted.

Carefully select an extension lead. Some machines are not suitable for use with extension leads. If the tool is designed for use outdoors, only use an extension lead suitable for that environment in conjunction with an RCD adaptor. When using an extension lead, select one capable of handling the current (amps) drawn by the machine in use. Ensure the cable is fully unwound regardless of the distance between the power supply and the tool. Excess current (amps) and a coiled extension lead will cause the cable to heat up and can result in fire.

Keep extension leads away from moving hazardous parts to avoid damages to the cable which can lead to contact with live parts. Position cable safely to avoid tripping over.

†Double insulated : This product requires no earth connection as supplementary insulation is applied to the basic insulation to protect against electric shock in the event of failure of the basic insulation.

Important! If using an extension lead, follow the instructions that came with your lead regarding maximum load while cable is wound. If in doubt, ensure that the entire cable is unwound. Using a coiled extension lead will generate heat which could melt the lead and cause a fire.

5.4 RESIDUAL RISK

Important: Although the safety instructions and operating manuals for our tools contain extensive instructions of safe working with power tools, every power tool involves a certain residual risk which can not be completely excluded by safety mechanisms. Power tools must therefore always be operated with caution!

6. TECHNICAL DESCRIPTION

6.1 IDENTIFICATION

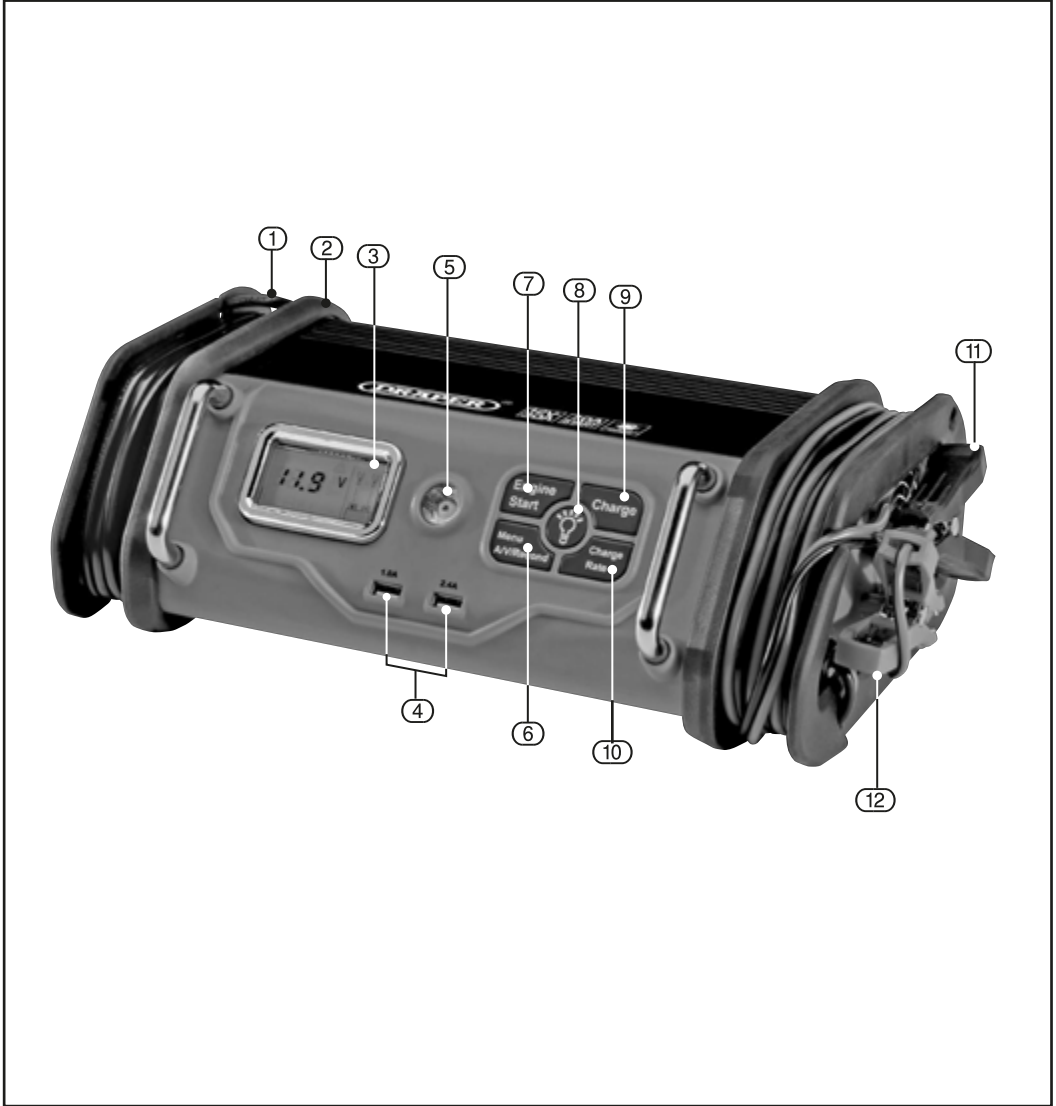

- ① Power cord storage.
- ② Non-slip feet.
- ③ LCD display.
- ④ 2x USB Ports 1.5A & 2.4A.
- ⑤ LED worklight.
- ⑥ Menu, Reconditioning function, Amp or Volt.
- ⑦ Engine start function.
- ⑧ LED worklight switch.
- ⑨ Charge on/off function.
- ⑩ Charge rates (2A, 5A, 10A, 20A, 30A).
- ⑪ Battery terminal - negative (BLACK) clamp.
- ⑫ Battery terminal - positive (RED) clamp.

7. UNPACKING AND CHECKING

7.1 PACKAGING

Carefully remove the product from the packaging and examine it for any sign of damage that may have happened during shipping. Lay the contents out and check them against the parts shown below. If any part is damaged or missing, please contact the Draper Help Line (the telephone number appears on the Title page) and do not attempt to use the product.

The packaging material should be retained at least during the warranty period, in case the machine needs to be returned for repair.

Warning!

- Some of the packaging materials used may be harmful to children. Do not leave any of these materials in the reach of children.
- If any of the packaging is to be thrown away, make sure they are disposed of correctly, according to local regulations.

8. PREPARING THE BATTERY CHARGER

8.1 BEFORE CHARGING YOUR BATTERY – FIGS. 1 – 2

We recommend that the battery is disconnected from the vehicle, this will avoid any possible damage to the alternator.

Loss of codes for audio and security etc, can be prevented by connecting a Draper Memory Saver – Stock No. 22277 12V socket type (Fig.1), or Stock No. 22231 EOBD 16pin diagnostic socket type (Fig.2) before disconnecting the battery. Check that the voltage of the battery matches that of the charger.



FIG.1



FIG.2

9. OPERATION

9.1 CHARGING YOUR BATTERY

Before you connect the equipment to the power supply make sure that the data on the specifications label are identical to the supply voltage.

 **Warning!** Do not charge any frozen batteries.

Please also refer to the instructions in the owner's manuals for the car, radio, navigation system, etc.

Setup:

1. Plug the battery charger into an AC socket.

The LCD will display the following (the Voltage icon, the clamp icons, the battery icon)

2. Connect the battery clamps.

With a battery removed from vehicle:

- a. Connect the RED positive charger lead to the positive (+) terminal on your battery.
- b. Connect the BLACK negative charger lead to the negative (-) terminal on your battery.

With a battery connected to vehicle:

Note: All loads in the vehicle must be switched off during charging.

- a. Connect the RED positive charger lead to the positive (+) terminal on your battery.
- b. Connect the BLACK negative charger lead to your vehicles ground connection on either the engine or chassis, away from any fuel lines or the battery vents.

If the clamps are INCORRECTLY connected with regard to polarity, the LCD screen will display the following (the + and - inside the battery icon, the fault icon  and "Err"), and a warning will sound until the clamps are disconnected. Unplug the charger, then remove the clamps, reconnect the clamps properly.

-  **Warning!** Under normal circumstances the negative battery pole is connected to the bodywork and you proceed as described above. In exceptional cases (refer to the manufacturers manual) it is possible that the positive battery pole is connected to the bodywork (*positive earthing*). In this case connect the black charger cable to the negative pole on the battery. Then connect the red charger cable to the bodywork at a point away from the battery and the petrol pipe.

3. Press the Charge button  on the control panel.

The LCD screen will display the output current that is charging the battery, the clamp icons and the battery icon, the bars on the battery icon will change from empty to solid (bottom to top) repeatedly.

Note: Default charging current is 20A, it can be changed by pressing "Charge Rate" , the sequence is 2A/5A/10A/20A/30A

Important: If the unit is overheated, the LCD screen will display the following (overheat alarm icon , fault icon, battery icon and the clamp icons), disconnect the charger and allow the charger to cool for several minutes. Make sure there is adequate ventilation around the unit before attempting to charge again.

4. When the battery is completely charged, the unit automatically goes into float charge mode.

When disconnecting charger,

- 1st Disconnect plug from AC socket.
- 2nd Remove clamp from vehicle chassis.
- 3rd Remove clamp from battery terminal.

9. OPERATION

9.2 RECONDITIONING THE BATTERY

When the battery voltage is lower than 8V, if you press the charge button (9), it won't work, the LCD screen will display "LO" with sound alarm.

Periodic reconditioning is recommended to maintain a battery optimum performance. Battery recondition sends a series of electrical pulses to break up the crystalline form of lead sulphate and turn these chemicals into useful battery electrolytes.

Setup:

1. Connect AC power and connect the clamps to battery correctly.
2. Press "Menu/A/V/Recond" button (6) to select Recondition mode.
3. Press "Charge" button (9) to start recondition

Note: Recondition will continue for 2 hours, then the charger will automatically turn to normal charging mode.

Important: If you press "Charge" (9) first, the charger will start normal charging, in this case, the Recond can not be started by pressing "Menu/A/V/Recond" (6), you must stop charging by pressing "Charge" button (9) (this is start/stop charging button).

Important: If 5 cycles of reconditioning does not improve battery performance, discontinue and recycle the battery. The battery charger will go into charging mode after 24 hours automatically.

When disconnecting charger,

- 1st Disconnect plug from AC socket.
- 2nd Remove clamp from vehicle chassis.
- 3rd Remove clamp from battery terminal.

9.3 USING THE ENGINE START FUNCTION

Setup:

1. Setup the battery charger and connect to the battery followings steps 1 of 9.1 section.
2. Press the engine start button (7).
3. The engine start icon will be shown on the screen. The vehicle is ready to start.
4. Crank the engine (as manufacturer's guidelines), typically in 3 to 5 second bursts.
The digital display shows "5sec" indicating a 5-second countdown.

Note: Connect the battery first, then press Engine Start button (7), otherwise, it won't work, and the LCD screen will display "LO" with sound alarm.

Important: The function requires a resting / cooling period between attempts.

Wait 4 to 5 minutes before a second attempt at starting the engine, if needed.

When disconnecting charger,

- 1st Disconnect plug from AC socket.
- 2nd Remove clamp from vehicle chassis.
- 3rd Remove clamp from battery terminal.

10. MAINTENANCE AND TROUBLESHOOTING

10.1 MAINTENANCE

Regular inspection and cleaning reduces the necessity for maintenance operations and will keep your tool in good working condition.

The motor must be correctly ventilated during tool operation. Avoid blocking the air inlets and vacuum the ventilation slots regularly.

10.2 TROUBLESHOOTING GUIDE

Problem	Possible Cause	Remedy
Unit not charging.	1. Loose connections.	1. Make sure all connection are secure.
	2. No power.	3. Check unit is plugged into socket.

Note: If the battery to be charged has fallen below 2 volts, the battery cannot be recharged with this charger.

11. EXPLANATION OF SYMBOLS

11.1 EXPLANATION OF SYMBOLS



Read the instruction manual.



Do not abandon into the environment.



Keep out of the reach of children.



Warning!



Do not incinerate or throw onto fire.



For indoor use only.
Do not expose to rain.



Short-circuit-proof safety isolating transformer.

F



130°

Fuse protective device.



Polarity indication.



Rated voltage.



Class II construction
(Double insulated).



WEEE –
Waste Electrical & Electronic Equipment.
Do not dispose of Waste Electrical & Electronic
Equipment in with domestic rubbish.

12. DISPOSAL

12.1 DISPOSAL

- At the end of the machine's working life, or when it can no longer be repaired, ensure that it is disposed of according to national regulations.
- Contact your local authority for details of collection schemes in your area.

In all circumstances:

- Do not dispose of power tools with domestic waste.
- Do not incinerate.
- Do not dispose of WEEE* as unsorted municipal waste.



* Waste Electrical & Electronic Equipment.

CONTACTS

Draper Tools Limited, Hursley Road,
Chandler's Ford, Eastleigh, Hampshire. SO53 1YF. U.K.

Help Line: (023) 8049 4344

Sales Desk: (023) 8049 4333

Internet: drapertools.com

E-mail: sales@drapertools.com

General Enquiries: (023) 8026 6355

Service/Warranty Repair Agent:

For aftersales servicing or warranty repairs, please contact the Draper Tools Help Line for details of an agent in your local area.

YOUR DRAPER STOCKIST

RDMC0820

©Published by Draper Tools Limited.

No part of this publication may be reproduced, stored in a retrieval system or transmitted in any form or by any means, electronic, mechanical photocopying, recording or otherwise without prior permission in writing from Draper Tools Ltd.