

DRAPER

EN

Original Instructions
Version 1
December 2025

18V

HEDGE TRIMMER

31862



These are the original product instructions.
Read the instruction manual in full and retain
for future reference.

Please visit [drapertools.com/manuals](https://www.drapertools.com/manuals) for the latest
version of this manual and the associated parts list,
if applicable.

UK
CA CE

1. Preface

1.1 Product Reference

User Manual for: 18V Hedge Trimmer

Stock No: 31862

Part No.: DXG08

1.2 Revisions

Version 1: December 2025

First release

As our manuals are continually updated, always ensure that the latest version is used.

Please visit drapertools.com/manuals for the latest version of this manual and the associated parts list, if applicable.

1.3 Understanding the Safety Content of This Manual



WARNING! – Situations or actions that may result in personal injury or death.



CAUTION! – Situations or actions that may result in damage to the product or surroundings.

Important: – Information or instructions of particular importance.

1.4 Copyright © Notice

Copyright © Draper Tools Limited.

Permission is granted to reproduce this manual for personal and educational use **ONLY**. Commercial copying, redistribution, hiring or lending is strictly prohibited.

No part of this manual may be stored in a retrieval system or transmitted in any other form or means without written permission from Draper Tools Limited.

In all cases, this copyright notice must remain intact.

2. Contents

1. Preface	2
1.1 Product Reference	2
1.2 Revisions	2
1.3 Understanding the Safety Content of This Manual	2
1.4 Copyright © Notice	2
2. Contents	2
3. Product Introduction	3
3.1 Intended Use	3
3.2 Specification	3
4. Health and Safety Information	4-8
4.1 General Power Garden Tool Safety Warnings	4
4.2 Additional Safety Warnings for Hedge Trimmers	6
4.3 Safety instructions for Main Powered Chargers & Battery Packs	7
4.4 Connection to the Power Supply (Charger)	8
4.5 Residual Risk	8
5. Identification and Unpacking	9
6. Preparation	10
6.1 Charging the Battery	10
6.2 Battery Pack Charge Status	10
6.3 Tool Battery Fitting	10
7. Operating the Hedge Trimmer	11
7.1 Basic Operation	11
8. Maintenance and Storage	12
8.1 General Maintenance	12
8.2 Troubleshooting Guide	12
9. Disposal	13
10. Warranty	13
11. Explanation of Symbols	13

3. Product Introduction

3.1 Intended Use

This cordless trimmer is designed for cutting and trimming hedges, shrubs and bushes with branches up to 17mm in diameter.

Any other application beyond the conditions established for use will be considered misuse. Draper Tools accepts no responsibility for improper use of this product.

This product is intended for domestic use only.

3.2 Specification

Stock No.	31862
Part No.	DXG08
Rated Voltage	18V
Blade length	560mm
Maximum cutting capacity	17mm
Speed (no load)	1,400rpm

Noise Emissions

Sound pressure level	78.16dB(A)
Uncertainty (K)	3dB (A)
Sound power level	86.16dB (A)
Guaranteed sound power level	96dB (A)

Vibration level

Front handle	2.7m/s ²
Rear handle	2.54m/s ²
Uncertainty (K)	1.5m/s ²
Net Weight (without battery)	2.2kg
Run time with no load (approx.)	30 mins

2.0Ah Battery Pack

Type	Li-ion
Rating	2000mAh/36Wh
Rated voltage	18V

2.4A Charger

Rated Input	230V/50Hz
Rated output	43.2W

Rated DC Output

Voltage	18V
Current	2.4A
Construction	Class II
Charging temperature	5 to 30°C
Charging time (approx.)	60mins (2Ah battery)

Important: The declared vibration total values and noise emissions values have been measured in accordance with a standard test method and may be used for comparing one tool with another. These values may also be used in a preliminary assessment of exposure.



WARNING! The vibration and noise emissions during actual use of the product can differ from the declared values depending on the type of work and the area upon which it is used. Before each use, estimate the likely exposure resulting from the actual conditions of use. Take into account **all** parts of the operation cycle in order to identify any safety measures required to protect the operator.

4. Health and Safety Information

4.1 General Power Garden Tool Safety Warnings



WARNING! Read all safety warnings, instructions, illustrations and specifications provided with this garden power tool. Failure to follow all instructions listed below may result in electric shock, fire and/or serious injury.

Save all warnings and instructions for future reference.

The term 'power tool' in the warnings refers to your mains-operated (corded) garden power tool or battery-operated (cordless) garden power tool.

Work Area Safety

- **Keep work area clean and well lit.**
 - Cluttered or dark areas invite accidents.
- **DO NOT operate power tools in explosive atmospheres, such as in the presence of flammable liquids, gases or dust.**
 - Power tools create sparks which may ignite the dust or fumes.
- **Keep children and bystanders away while operating a power tool.**
 - Distractions can cause you to lose control.

Electrical Safety

- **Power tool plugs must match the outlet. NEVER modify the plug in any way. DO NOT use any adapter plugs with earthed (grounded) power tools.**
 - Unmodified plugs and matching outlets will reduce risk of electric shock.
- **Avoid body contact with earthed or grounded surfaces, such as pipes, radiators, ranges and refrigerators.**
 - There is an increased risk of electric shock if your body is earthed or grounded.
- **DO NOT expose power tools to rain or wet conditions.**
 - Water entering a power tool will increase the risk of electric shock.
- **DO NOT abuse the cord. NEVER use the cord for carrying, pulling or unplugging the power tool. Keep cord away from heat, oil, sharp edges or moving parts.**
 - Damaged or entangled cords increase the risk of electric shock.
- **When operating a power tool outdoors, use an extension cord suitable for outdoor use.**
 - Use of a cord suitable for outdoor use reduces the risk of electric shock.

- **If operating a power tool in a damp location is unavoidable, use a residual current device (RCD) protected supply.**
 - Use of an RCD reduces the risk of electric shock.

Personal Safety

- **Stay alert, watch what you are doing and use common sense when operating a power tool. DO NOT use a power tool while you are tired or under the influence of drugs, alcohol or medication.**
 - A moment of inattention while operating power tools may result in serious personal injury.
- **Use personal protective equipment. Always wear eye protection.**
 - Protective equipment such as a dust mask, non-skid safety shoes, hard hat or hearing protection used for appropriate conditions will reduce personal injuries.
- **Prevent unintentional starting. Ensure the switch is in the 'OFF' position before connecting to power source, picking up or carrying the tool.**
 - Carrying power tools with your finger on the switch or energising power tools that have the switch on invites accidents.
- **Remove any adjusting key or wrench before turning the power tool on.**
 - A wrench or a key left attached to a rotating part of the power tool may result in personal injury.
- **DO NOT overreach. Keep proper footing and balance at all times.**
 - This enables better control of the power tool in unexpected situations.
- **Dress properly. DO NOT wear loose clothing or jewellery. Keep your hair, clothing and gloves away from moving parts.**
 - Loose clothes, jewellery or long hair can be caught in moving parts.
- **If devices are provided for the connection of dust extraction and collection facilities, ensure these are connected and properly used.**
 - Use of dust collection can reduce dust-related hazards.
- **DO NOT let familiarity gained from frequent use of tools allow you to become complacent and ignore tool safety principles.**
 - A careless action can cause severe injury within a fraction of a second.

Power Tool Use and Care

- **DO NOT force the power tool. Use the correct power tool for your application.**
 - The correct power tool will do the job better and safer at the rate for which it was designed.
- **DO NOT use the power tool if the switch does not turn it on and off.**
 - Any power tool that cannot be controlled with the switch is dangerous and must be repaired.
- **Disconnect the plug from the power source and/or remove the battery pack, if detachable, from the power tool, before making any adjustments, changing accessories or storing power tools.**
 - Such preventive safety measures reduce the risk of starting the power tool accidentally.
- **Store idle power tools out of the reach of children and DO NOT allow persons unfamiliar with the power tool or these instructions to operate the power tool.**
 - Power tools are dangerous in the hands of untrained users.
- **Maintain power tools and accessories. Check for misalignment or binding of moving parts, breakage of parts and any other condition that may affect the power tool's operation. If damaged, have the power tool repaired before use.**
 - Many accidents are caused by poorly maintained power tools.
- **Keep cutting tools sharp and clean.**
 - Properly maintained cutting tools with sharp cutting edges are less likely to bind and are easier to control.
- **Use the power tool, accessories and tool bits etc. in accordance with these instructions, taking into account the working conditions and the work to be performed.**
 - Use of the power tool for operations different from those intended could result in a hazardous situation.
- **Keep handles and grasping surfaces dry, clean and free from oil and grease.**
 - Slippery handles and grasping surfaces **DO NOT** allow for safe handling and control of the tool in unexpected situations.



Service

- **Have your power tool serviced by a qualified repair person using only identical replacement parts.**
 - This will ensure that the safety of the power tool is maintained.
- **NEVER service damaged battery packs. Service of battery packs should only be performed by the manufacturer or authorised service providers.**

Battery Tool Use and Care

- **Recharge only with the charger specified by the manufacturer.**
 - A charger that is suitable for one type of battery pack may create a risk of fire when used with another battery pack.
- **Use power tools only with specifically designated battery packs.**
 - Use of any other battery packs may create a risk of injury and fire.
- **When battery pack is not in use, keep it away from other metal objects, like paper clips, coins, keys, nails, screws or other small metal objects, that can make a connection from one terminal to another.**
 - Shorting the battery terminals together may cause burns or a fire.
- **ALWAYS switch off the tool and remove the battery before changing accessories or adjusting the tool.**
- **DO NOT use a battery pack or tool that is damaged or modified.**
 - Damaged or modified batteries may exhibit unpredictable behaviour resulting in fire, explosion or risk of injury.
- **DO NOT expose a battery pack or tool to fire or excessive temperature.**
 - Exposure to fire or temperature above 130 °C may cause explosion.
- **Follow all charging instructions and DO NOT charge the battery pack or tool outside the temperature range specified in the instructions.**
 - Charging improperly or at temperatures outside the specified range may damage the battery and increase the risk of fire.
- **If the tool is operated continuously until the battery pack has discharged, allow the tool to rest for 15 minutes before continuing with a fresh battery.**

4.2 Additional Safety Warnings for Hedge Trimmers

- **Keep all parts of the body away from the blade. DO NOT remove cut material or hold material to be cut when blades are moving.**
 - Blades continue to move after the switch is turned off. A moment of inattention while operating the hedge trimmer may result in personal injury.
 - **Carry the hedge trimmer by the handle with the blade stopped and take care not to operate any power switches.**
 - Proper handling of the hedge trimmer will decrease the risk of inadvertent starting and resultant personal injury from the blades.
 - **When clearing jammed material or servicing the tool, make sure all power switches are off and the power cord/battery pack is disconnected.**
 - Unexpected actuation of the hedge trimmer while clearing jammed material or servicing may result in serious personal injury.
 - **Hold the hedge trimmer by insulated gripping surfaces only, because the blade may contact hidden wiring.**
 - Blades contacting a “live” wire may make exposed metal parts of the hedge trimmer “live” and could give the operator an electric shock.
 - **Keep all power cords and cables away from the cutting area.**
 - Power cords or cables may be hidden in hedges or bushes and can be accidentally cut by the blade.
 - **DO NOT use the hedge trimmer in bad weather conditions, especially when there is a risk of lightning.**
 - This decreases the risk of being struck by lightning.
-  **WARNING! DO NOT touch moving parts. Switch off and remove the battery from the trimmer and wait until the moving parts have come to a complete stop. Cutting parts continue to move after the tool is switched off.**
-  **WARNING! Keep hands away from blade.**
 - Contact with blade will result in serious personal injury.- **DO NOT** use the hedge trimmer in the rain or in wet or very damp conditions. The motor is not waterproof.
- First-time users should have an experienced hedge trimmer user show them how to use the trimmer.
- Children or persons unfamiliar with these instructions must not operate the hedge trimmer. Local regulations may restrict the age of the operator.
- Use the hedge trimmer only if you are in good physical condition. If you are tired, your attention will be reduced.
- The operator is responsible for accidents causing injury to other people or damage to property.
- **NEVER** use the trimmer when under the influence of alcohol, drugs or medication. alcohol, drugs or medication.
- **NEVER** operate the machine while people, especially children, or pets are nearby.
- Wear appropriate PPE (personal protective equipment) including hearing and eye protection.
 - **ALWAYS** wear appropriate sturdy work gloves when operating the hedge trimmer.
 - **ALWAYS** wear substantial footwear with anti-skid soles and long trousers while operating the trimmer.
- Before each use visually inspect the trimmer for missing or damaged cutting parts. Check for signs of wear or damage and replace parts if necessary. Ensure guards are fitted properly. The hedge trimmer must not be used unless fully assessed.
- **DO NOT** overreach and keep your balance at all times.
- Hold the tool firmly using the front and rear handle when using the tool.
- **DO NOT** operate the tool at no-load unnecessarily.
- Immediately switch off the trimmer and remove the battery pack if the blade should come into contact with a fence or other hard object. Check the blade for damage, and if damaged repair immediately.
- **ALWAYS** switch off the trimmer and remove the battery pack before:
 - Checking the blade.
 - Removing material caught in the blade.
 - Carrying out any maintenance.
- When moving the hedge trimmer to another location, including during work, always remove the battery pack and fit the blade cover over the cutter blades.
- **NEVER** carry or transport the trimmer with the cutter running.
- Check the hedge and bushes for foreign objects such as wire fence and hidden wiring.

- The hedge trimmer should only be used at ground level. **DO NOT** use on a ladder or any other unstable support.
- **NEVER** grasp the blade with your hands.
- This tool is not intended for use by persons (including children) with reduced physical, sensory or mental capabilities, or lack of experience and knowledge, unless they have been given supervision or instructions concerning use of the appliance by a person responsible for their safety. Cleaning and user maintenance shall not be made by children.
- Children should be supervised to ensure they **DO NOT** play with the tool.
- Only use replacement parts and accessories recommended by Draper Tools.
- Keep the ventilation openings clear of debris.
- The trimmer should only be serviced and repaired by an authorised repairer.

4.3 Safety instructions for Main Powered Chargers & Battery Packs

- Before using the battery pack or charger, read all instructions and cautionary markings on the battery, charger and the product using the battery.

Chargers

- The charger is for indoor use only. **DO NOT** expose to rain.
- Prior to plugging the charger in to the supply, check that the plug, cord and charger casing are in good condition. If any are damaged, have the defective part(s) replaced immediately by a suitably qualified person.
- **ONLY** use a correctly rated mains outlet to provide power, **DO NOT** plug into site generators, attach to engine generators or D.C. sources. **DO NOT** use a mains socket outlet that is not switched.
- Use the correct Draper charger in conjunction with its corresponding battery pack (Visit drapertools.com for more information).
- The charger must be disconnected from the power supply before removing the battery.
- **DO NOT** charge any other batteries with Draper chargers. Any other application is considered misuse.
- **DO NOT** attempt to charge non-rechargeable batteries.
- **DO NOT** attempt to charge battery packs that are too hot (over 30°C) or too cold (under 5°C), if these conditions apply set the battery pack aside to 'normalise' before proceeding with the charging

operation.

- Set up the charger and cord in a safe place where they will not be knocked, tripped over, stepped on, etc. and where it is well ventilated. Ensure the ventilation slots in the charger case are not obstructed.
- Switch the charger on and check that the correct indicators illuminate, allow the battery pack to charge. Once charging is complete, switch the charger off, disconnect from power supply, remove the battery pack and store.

Battery Packs

- **ONLY** use Draper recommended battery packs with this tool.
- Inspect the battery pack for damage, if it is undamaged, plug it into the charger, ensuring the correct orientation.
- **DO NOT** short the battery pack:
 - **DO NOT** touch the terminals with any conductive material.
 - Avoid storing battery pack in a container with other metal objects such as nails, coins, etc.
 - **DO NOT** expose battery pack to water or rain.
- The battery must be removed from the tool before it is recycled.
- The battery is to be disposed of in-line with local authority procedures.
- **DO NOT** crush, open or burn the battery. Exposure to potentially harmful materials may occur.
- In case of fire use CO2 or dry chemical extinguisher.
- **DO NOT** expose to high temperatures >50°C. The battery may degrade at high temperatures.
- Charge battery in conditions between 5°C to 30°C with the designated charger for the battery.
- **DO NOT** use battery if it has been stored at 5°C or less. Allow it to 'normalise' at room temperature before usage/charging.



WARNING! Leaking battery packs

- The electrolyte in battery packs is corrosive. Avoid contact with the skin.
- If contact is made, flush the area with clean water, pat dry and seek medical attention at the earliest opportunity.

4.4 Connection to the Power Supply (Charger)



CAUTION!

Risk of electric shock. DO NOT open.

This appliance is supplied with an approved plug and cord for your safety.

This appliance is Class II and is designed for connection to a power supply matching that detailed on the rating label and compatible with the plug fitted.

If the power supply cord is damaged, it must be replaced by Draper Tools, an authorised service agent or similarly qualified personnel in order to avoid a hazard.

The damaged or incomplete plug, when cut from the cord, shall be disabled to prevent connection to a live electrical outlet.

The value of the fuse fitted is marked on the pin face of the plug. Should the fuse need replacing, use a small plain-slot screwdriver to remove the fuse cover. Ensure the substitute is of the correct rating, approved to BS 1362 and ASTA or BS Kite marked. This should only be performed by suitably qualified personnel.

ASTA  BSI 

Important: If an extension lead is required, use an approved and compatible lead rated for this appliance.

Unwind the entire cable and follow all the instructions supplied with the extension lead.

†Double insulated : This product requires no earth connection as supplementary insulation is applied to the basic insulation to protect against electric shock in the event of failure of the basic insulation.

4.5 Residual Risks

The safety instructions in this manual cannot account for all possible conditions and situations that may occur. Exercise common sense and caution when using this product and protect against any additional conceivable risks.

5. Identification and Unpacking

EN

Carefully remove the product from the packaging and examine it for any signs of damage that may have occurred during shipment. If any part is damaged or missing, do not attempt to use the product. Please contact the Draper Helpline; contact details can be found at the back of this manual.



1. Battery compartment
2. Rear handle
3. **ON/OFF** trigger A
4. Safety lock button
5. **ON/OFF** trigger B
6. Front handle

7. Guard
8. Blade
9. Blade cover
10. Battery
11. Battery charger

Please visit drapertools.com for our full range of batteries, chargers, accessories and consumables.
This cordless product is also compatible with the D20 range of batteries and chargers.

6. Preparation

6.1 Charging the Battery

Important: **ONLY** use Draper designated battery packs and chargers with this product. Use of any other third-party battery packs/chargers is considered misuse and will invalidate the warranty. Once connected to the mains supply, recharging of the battery can be left generally unsupervised.

WARNING! Check the condition of the charger and battery prior to each charge. **DO NOT** use if there is any sign of damage. The battery pack must be charged before initial use.

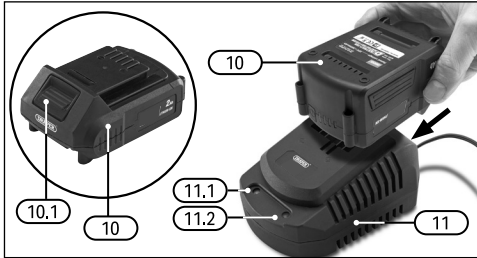

Fig. 1

1. Remove the battery (10) from the tool before charging by pressing the release button (10.1). Then slide the battery pack from the battery compartment (1).
2. Plug the battery charger (11) into a suitable mains power supply socket.
3. Slide the battery (10) into the charger (the battery is designed to fit into the charger only one way). Ensure the battery is fully inserted correctly into the charger.

Status	Indicator Lights	
	Green (11.2)	Red (11.1)
Charger plugged in	OFF	ON
Battery charging	Flashing	ON
Battery fully charged	ON	OFF
Foreign object in charger's battery slot/Faulty	-	Flickering

4. Once fully charged, unplug the charger and remove the battery from the charger by pressing the release button (10.1).
- Always unplug the charger after use.

CAUTION!

- **DO NOT** pull the plug out of the power outlet by the cord.
- If the battery charger has been in continuous use it will be hot. Once charging is completed, leave the charger to cool for at least 15 minutes. Only charge cooled batteries.

6.2 Battery Pack Charge Status

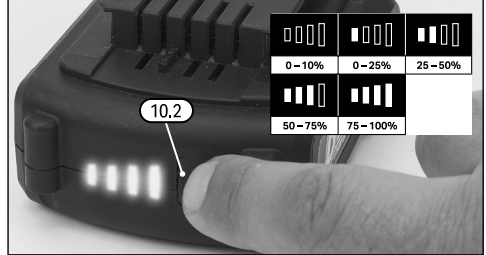

Fig. 2

- To check the battery (10) charge status press the charge level indicator button (10.2).

6.3 Tool Battery Fitting



Fig. 3

- Slide the battery pack (10) into the battery compartment (1) on the base of the handle.

To release the battery pack



Fig. 4

- Press the battery release button (10.1) and slide the battery pack off.

7. Operating the Hedge Trimmer

Important: Before operating this tool, read and understand all the safety instructions listed in this manual. Ensure that the product is fully assembled and the battery is fitted.

7.1 Basic Operation

- For safety the trimmer is equipped with a dual switch system and will only start when both triggers are activated.

CAUTION! Risk of injury

- Take care not to accidentally contact a metal fence or other hard objects while trimming as this may cause the blade to break.
- DO NOT** overreach or use a ladder while operating the trimmer. Only work on a firm stable surface.
- DO NOT** attempt to cut branches thicker than 17mm diameter.
- DO NOT** cut off dead trees or similar hard objects.

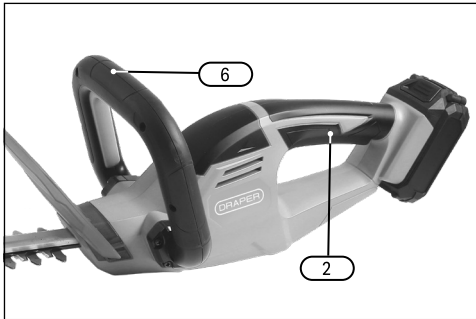

Fig. 5

1. Hold the the rear handle (2) and front handle (6) securely during operation.

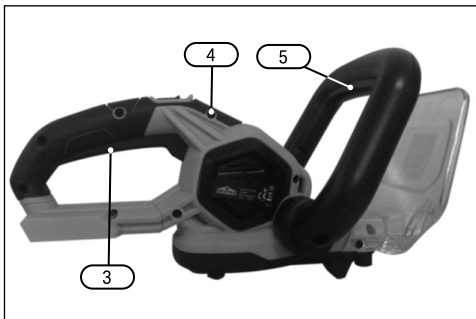

Fig. 6

2. Press the safety lock button (4) first, then squeeze both triggers (3) and (5) to operate the trimmer.
 3. To turn off release either of the trigger.
- For basic operation, tilt the blades in the trimming direction and move it slowly and evenly.

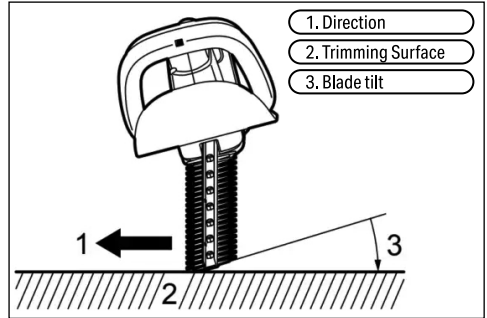

Fig. 7

- To help cut the top of the hedge evenly, use a line of string as a guide positioned at the correct hedge height.
- To cut the side of a hedge evenly – cut from the base upwards.
- For hedges such as boxwood or rhododendron trim from the base upwards for the best results.

8. Maintenance and Storage

Important: ALWAYS ensure the trimmer is switched off and the battery pack is removed before carrying out any cleaning, servicing or maintenance.

8.1 General Maintenance

- If the blade is damaged it must only be replaced by an authorised service agent.
- Clean the hedge trimmer cutter after use, and before putting the trimmer into storage for extended periods. Lightly oil the blade and fit the cover.
- Wipe over with mild soap and a damp cloth.
- Keep the trimmer dry and **DO NOT** spray with water.
- **DO NOT** use solvents or abrasives to clean the trimmer.
- Keep the ventilation slots clean free from debris.
- Store the trimmer with the blade cover on, in a safe dry area, out of the reach of children.
- **NEVER** store the trimmer outdoors.

8.2 Troubleshooting Guide

Problem	Possible Cause	Remedy
Trimmer will not operate.	Battery discharged.	Recharge battery - refer to 6.1.
	Battery not fitted.	Insert battery into handle battery compartment.
	ON/OFF trigger or motor defective.	Contact Draper Tools for advice.
Poor trimming performance.	Blade damaged.	Contact Draper Tools for advice.
	Insufficient battery charge.	Recharge battery - refer to 6.1.

9. Disposal

- At the end of its working life, dispose of the product responsibly and in line with local regulations. Recycle where possible.
- **DO NOT** dispose of this product with domestic waste; most local authorities provide appropriate recycling facilities.



Li-ion

- **DO NOT** incinerate.
- **DO NOT** burn or mutilate batteries; this may release toxic or corrosive substances.



- **DO NOT** short circuit cells, may cause burns.
- The battery pack must be removed from the tool before it is scrapped and disposed of safely.
- **DO NOT** dispose of batteries in a charged condition.
- Expired batteries must be recycled/disposed of in accordance with the appropriate regulation or legislation. They should be returned to your local warranty agent/stockist.

10. Warranty

12 months from date of purchase.

Visit drapertools.com/warranty for more information.

11. Explanation of Symbols EN



Read the instruction manual.



Wear ear defenders and safety glasses.



Wear protective footwear.



Wear protective gloves.



Keep out of the reach of children.



DO NOT incinerate or throw onto fire.



Warning!



Warning! Risk of electric shock.



DO NOT operate the machine indoors.



DO NOT expose to rain or wet conditions.



Class II construction (Double insulated).



Rated Voltage.



Maximum cutting diameter.



Cutting length.



Speed (no load).



WEEE – Waste Electrical & Electronic Equipment.
DO NOT dispose of this product with domestic waste



UK Conformity Assessed.



European conformity.

Contact Details

Draper Tools

Draper Tools Limited
Hursley Road
Chandler's Ford
Eastleigh
Hampshire
SO53 1YF
UK

Website: drapertools.com

Email: sales@drapertools.com

Product Helpline: +44 (0) 23 8049 4344

Telephone Sales Desk: +44 (0) 23 8049 4333

General Enquiries: +44 (0) 23 8026 6355

Draper Tools Europe B.V.

Oude Graaf 8
6002 NL
Weert
Netherlands

Please contact the Draper Tools Product Helpline for repair and servicing enquiries.