

230V 205/305MM

DOUBLE BEVEL SLIDING COMPOUND MITRE SAW

79899, 79901



79899

79901

1. Preface

1.1 Product Reference

User Manual for: 230V Double Bevel Sliding
Compound Mitre Saw

Stock No: 79899, 79901

Part No: SMS255E, SMS305E

1.2 Revisions

Version 1: January 2019
First release

Version 2: June 2022

Version 3: January 2026

As our manuals are continually updated, always ensure that the latest version is used.

Please visit drapertools.com/manuals for the latest version of this manual and the associated parts list, if applicable.

1.3 Understanding the Safety Content of This Manual



WARNING! – Situations or actions that may result in personal injury or death.



CAUTION! – Situations or actions that may result in damage to the product or surroundings.

Important: – Information or instructions of particular importance.

1.4 Copyright © Notice

Copyright © Draper Tools Limited.

Permission is granted to reproduce this manual for personal and educational use **ONLY**. Commercial copying, redistribution, hiring or lending is strictly prohibited.

No part of this manual may be stored in a retrieval system or transmitted in any other form or means without written permission from Draper Tools Limited.

In all cases, this copyright notice must remain intact.

2. Contents

1. Preface	2
1.1 Product Reference	2
1.2 Revisions	2
1.3 Understanding the Safety Content of This Manual	2
1.4 Copyright © Notice	2
2. Contents	2
3. Product Introduction	3
4. Health and Safety Information	4-7
4.1 General Health & Power Tool Safety Warnings	4
4.2 Specific Safety Instructions for Mitre Saws	5
4.3 Additional Safety Instructions for Circular Saw Blades	6
4.4 Additional Safety Instructions for Laser Products	7
4.5 Connection to the Power Supply	7
4.6 Residual Risk	7
5. Identification and Unpacking	8-9
5.1 Product Overview	8
5.2 What's in the Box?	9
5.3 Packaging	9
6. Preparation Instructions	10-14
7. Operation Instructions	15-17
8. Maintenance and Troubleshooting	18-20
9. Spares, Returns and Disposal	21
9. Warranty	22
10. Explanation of Symbols	23

3.1 Intended Use

This product is designed to cut wood such as timber frames and roof frames. This product is suitable for use by enthusiasts and tradespersons alike.

Any other application beyond the conditions established for use will be considered misuse. Draper tools accepts no responsibility for improper use of this product.

Read this manual in full before attempting to assemble, operate or maintain the product, and retain it for later use.

3.2 Specification

Important: The declared noise emissions values have been measured in accordance with a standard test method and may be used for comparing one tool with another. These values may also be used in a preliminary assessment of exposure.



WARNING! The noise emissions during actual use of the product can differ from the declared values depending on the type of work and the area upon which it is used. Before each use, estimate the likely exposure resulting from the actual conditions of use. Take into account all parts of the operation cycle in order to identify any safety measures required to protect the operator.

Stock No.	79899	79901
Part No.	SMS255E	SMS305E
Rated Voltage	230V/50Hz	230V/50Hz
Rated Input	2000W	2000W
Speed (no-load)	5000rpm	5000rpm
Blade diameter	255mm	305mm
Blade thickness	2.4mm	3mm
Bore diameter	30mm	30mm
Table angle range (left/Right)	0 - 45°	0 - 45°
Mitre table cut		
0 X 45° (Left and right)	90 X 215mm	105 X 235mm
Cross cut		
0 X 0°	90 X 315mm	105 X 340mm
Bevel cut		
0 X 45° (Left)	40 X 315mm	60 X 340mm
0 X 45° (Right)	38 X 315mm	40 X 340mm
Compound mitre cut		
45° R X 45° (Left)	40 X 215mm	60 X 235mm
45° L X 45° (Right)	38 X 215mm	40 X 235mm
Noise emissions		
Sound pressure level	94.7dB (A)	96dB (A)
Sound power level	107.7dB(A)	109dB (A)
Uncertainty	3dB (A)	3 dB (A)
Cord length (approx.)	1.6M	1.6M
Net weight:	17kg	22kg

4. Health and Safety Information

4.1 General Health and Power Tool Safety Warnings



WARNING! Read all safety warnings, instructions, illustrations and specifications provided with this power tool. Failure to follow all instructions listed below may result in electric shock, fire and/or serious injury.

Save all warnings and instructions for future reference.

The term 'power tool' in the warnings refers to your mains-operated (corded) power tool or battery-operated (cordless) power tool.

Work Area Safety

- **Keep work area clean and well lit.**
 - Cluttered or dark areas invite accidents.
- **DO NOT operate power tools in explosive atmospheres, such as in the presence of flammable liquids, gases or dust.**
 - Power tools create sparks which may ignite the dust or fumes.
- **Keep children and bystanders away while operating a power tool.**
 - Distractions can cause you to lose control.

Electrical Safety

- **Power tool plugs must match the outlet. NEVER modify the plug in any way. DO NOT use any adapter plugs with earthed (grounded) power tools.**
 - Unmodified plugs and matching outlets will reduce risk of electric shock.
- **Avoid body contact with earthed or grounded surfaces, such as pipes, radiators, ranges and refrigerators.**
 - There is an increased risk of electric shock if your body is earthed or grounded.
- **DO NOT expose power tools to rain or wet conditions.**
 - Water entering a power tool will increase the risk of electric shock.
- **DO NOT abuse the cord. NEVER use the cord for carrying, pulling or unplugging the power tool. Keep cord away from heat, oil, sharp edges or moving parts.**
 - Damaged or entangled cords increase the risk of electric shock.

- **When operating a power tool outdoors, use an extension cord suitable for outdoor use.**
 - Use of a cord suitable for outdoor use reduces the risk of electric shock.
- **If operating a power tool in a damp location is unavoidable, use a residual current device (RCD) protected supply.**
 - Use of an RCD reduces the risk of electric shock.

Personal Safety

- **Stay alert, watch what you are doing and use common sense when operating a power tool. DO NOT use a power tool while you are tired or under the influence of drugs, alcohol or medication.**
 - A moment of inattention while operating power tools may result in serious personal injury.
- **Use personal protective equipment. ALWAYS wear eye protection.**
 - Protective equipment such as a dust mask, non-skid safety shoes, hard hat or hearing protection used for appropriate conditions will reduce personal injuries.
- **Prevent unintentional starting. Ensure the switch is in the 'OFF' position before connecting to power source, picking up or carrying the tool.**
 - Carrying power tools with your finger on the switch or energising power tools that have the switch on invites accidents.
- **Remove any adjusting key or wrench before turning the power tool on.**
 - A wrench or a key left attached to a rotating part of the power tool may result in personal injury.
- **DO NOT overreach. Keep proper footing and balance at all times.**
 - This enables better control of the power tool in unexpected situations.
- **Dress properly. DO NOT wear loose clothing or jewellery. Keep your hair, clothing and gloves away from moving parts.**
 - Loose clothes, jewellery or long hair can be caught in moving parts.
- **If devices are provided for the connection of dust extraction and collection facilities, ensure these are connected and properly used.**
 - Use of dust collection can reduce dust-related hazards.

- **DO NOT let familiarity gained from frequent use of tools allow you to become complacent and ignore tool safety principles.**
 - A careless action can cause severe injury within a fraction of a second.

Power Tool Use and Care

- **DO NOT force the power tool. Use the correct power tool for your application.**
 - The correct power tool will do the job better and safer at the rate for which it was designed.
- **DO NOT use the power tool if the switch does not turn it on and off.**
 - Any power tool that cannot be controlled with the switch is dangerous and must be repaired.
- **Disconnect the plug from the power source and/or remove the battery pack, if detachable, from the power tool, before making any adjustments, changing accessories or storing power tools.**
 - Such preventive safety measures reduce the risk of starting the power tool accidentally.
- **Store idle power tools out of the reach of children and DO NOT allow persons unfamiliar with the power tool or these instructions to operate the power tool.**
 - Power tools are dangerous in the hands of untrained users.
- **Maintain power tools and accessories. Check for misalignment or binding of moving parts, breakage of parts and any other condition that may affect the power tool's operation. If damaged, have the power tool repaired before use.**
 - Many accidents are caused by poorly maintained power tools.
- **Keep cutting tools sharp and clean.**
 - Properly maintained cutting tools with sharp cutting edges are less likely to bind and are easier to control.
- **Use the power tool, accessories and tool bits etc. in accordance with these instructions, taking into account the working conditions and the work to be performed.**
 - Use of the power tool for operations different from those intended could result in a hazardous situation.
- **Keep handles and grasping surfaces dry, clean and free from oil and grease.**

- Slippery handles and grasping surfaces **DO NOT** allow for safe handling and control of the tool in unexpected situations.

Service

- **Have your power tool serviced by a qualified repair person using only identical replacement parts. This will ensure that the safety of the power tool is maintained.**

4.2 Specific Safety Instructions for Mitre Saws

- **Mitre saws are intended to cut wood or wood-like products. They cannot be used with abrasive cut-off wheels for cutting ferrous material such as bars, rods, studs, etc.**
 - Abrasive dust causes moving parts such as the lower guard to jam. Sparks from abrasive cutting will burn the lower guard, the kerf insert and other plastic parts.
- **Use clamps to support the workpiece whenever possible. If supporting the workpiece by hand, you must ALWAYS keep your hand at least 100 mm from either side of the saw blade. DO NOT use this saw to cut pieces that are too small to be securely clamped or held by hand.**
 - If your hand is placed too close to the saw blade, there is an increased risk of injury from blade contact.
- **The workpiece must be stationary and clamped or held against both the fence and the table. DO NOT feed the workpiece into the blade or cut 'freehand' in any way.**
 - Unrestrained or moving workpieces could be thrown at high speeds, causing injury.
- **Push the saw through the workpiece. DO NOT pull the saw through the workpiece. To make a cut, raise the saw head and pull it out over the workpiece without cutting, start the motor, press the saw head down and push the saw through the workpiece.**
 - Cutting on the pull stroke is likely to cause the saw blade to climb on top of the workpiece and violently throw the blade assembly towards the operator.
- **NEVER cross your hand over the intended line of cutting either in front or behind the saw blade.**
 - Supporting the workpiece 'cross handed' i.e. holding the workpiece to the right of the saw blade with your left hand or vice versa is very dangerous.

-
- **DO NOT reach behind the fence with either hand closer than 100 mm from either side of the saw blade, to remove wood scraps, or for any other reason while the blade is spinning.**
 - The proximity of the spinning saw blade to your hand may not be obvious and you may be seriously injured.
 - **Inspect your workpiece before cutting. If the workpiece is bowed or warped, clamp it with the outside bowed face toward the fence. ALWAYS ensure that there is no gap between the workpiece, fence and table along the line of the cut.**
 - Bent or warped workpieces can twist or shift and may cause binding on the spinning saw blade while cutting. There should be no nails or foreign objects in the workpiece.
 - **DO NOT use the saw until the table is clear of all tools, wood scraps, etc., except for the workpiece.**
 - Small debris or loose pieces of wood or other objects that contact the revolving blade can be thrown with high speed.
 - **Cut only one workpiece at a time.**
 - Stacked multiple workpieces cannot be adequately clamped or braced and may bind on the blade or shift during cutting.
 - **Ensure the mitre saw is mounted or placed on a level, firm work surface before use.**
 - A level and firm work surface reduces the risk of the mitre saw becoming unstable.
 - **Plan your work. Every time you change the bevel or mitre angle setting, ensure the adjustable fence is set correctly to support the workpiece and will not interfere with the blade or the guarding system.**
 - Without turning the tool 'ON' and with no workpiece on the table, move the saw blade through a complete simulated cut to ensure there will be no interference or danger of cutting the fence.
 - **Provide adequate support such as table extensions, sawhorses, etc. for a workpiece that is wider or longer than the tabletop.**
 - Workpieces longer or wider than the mitre saw table can tip if not securely supported. If the cut-off piece or workpiece tips, it can lift the lower guard or be thrown by the spinning blade.
 - **DO NOT use another person as a substitute for a table extension or as additional support.**
 - Unstable support for the workpiece can cause the blade to bind or the workpiece to shift during the cutting operation pulling you and the helper into the spinning blade.
 - **The cut-off piece must not be jammed or pressed by any means against the spinning saw blade.**
 - If confined, i.e. using length stops, the cut-off piece could get wedged against the blade and thrown violently.
 - **ALWAYS use a clamp or a fixture designed to properly support round material such as rods or tubing.**
 - Rods tend to roll while being cut, causing the blade to 'bite' and pull the work with your hand into the blade.
 - **Let the blade reach full speed before contacting the workpiece.**
 - This will reduce the risk of the workpiece being thrown.
 - **If the workpiece or blade becomes jammed, turn the mitre saw off. Wait for all moving parts to stop and disconnect the plug from the power source and/or remove the battery pack; then work to free the jammed material.**
 - Continued sawing with a jammed workpiece could cause loss of control or damage to the mitre saw.
 - **After finishing the cut, release the switch, hold the saw head down and wait for the blade to stop before removing the cut-off piece.**
 - Reaching with your hand near the coasting blade is dangerous
 - **If the machine is equipped with a brake.**
 - Hold the handle firmly when making an incomplete cut or when releasing the switch before the saw head is completely in the down position. The braking action of the saw may cause the saw head to be suddenly pulled downward, causing a risk of injury.
- #### 4.3 Additional Safety Instructions for Circular Saw Blades
- **Maximum speed. The maximum speed marked on the tool shall not be exceeded. Where stated, the speed range shall be adhered to.**
 - Use of loose rings or bushes to 'make up' bore sizes on circular saw blades shall not be permitted.

4.4 Additional Safety Instructions for Laser Products

The laser used in this product is a Class 2 laser with a maximum power of <math><1\text{mW}</math> and a wavelength of 630 – 650nm.



WARNING! Avoid direct eye contact with the laser. The laser should not normally present an optical hazard, however, there is a risk of flash blindness when staring directly at the beam.

Please observe the following safety rules:

- The laser must be operated and maintained in accordance to the manufacturer's guidelines and instructions.
- **NEVER** switch the laser guide on until the tool is in the correct cutting position.
- **NEVER** aim the beam into the eyes of any person, animal, or any other object other than the workpiece.
- **ALWAYS** ensure the laser is aimed at suitable workpiece that has non-reflective surfaces, such as wood or other similar rough-coated surfaces. Reflective metallic surfaces such as sheet steel, or similar, are not suitable as the laser beam guide could be reflected back at the operator.
- **DO NOT** modify or adjust the laser light assembly. Repairs must only be carried out by the manufacturer or an authorised agent. **DO NOT** fit a different type of laser to the product.

WARNING! Use of controls, adjustments or performance of procedures other than those specified herein could result in hazardous radiation exposure.

4.5 Connection to the Power Supply

CAUTION! Risk of electric shock. **DO NOT OPEN.**

This product is supplied with an approved plug and cord for your safety.

If the power supply cord is damaged, it must be replaced by Draper Tools, an authorised service agent or similarly qualified personnel in order to avoid a hazard.

The damaged or incomplete plug, when cut from the cord, shall be disabled to prevent connection to a live electrical outlet.

This appliance is Class II[†] and is designed for connection to a power supply matching that detailed on the rating label and compatible with the plug fitted.

The value of the fuse fitted is marked on the pin face of the plug. Should the fuse need replacing, ensure the substitute is of the correct rating, approved to BS1362 and ASTA or BSI Kite marked.

ASTA  BSI 

The fuse cover is removable with a small plain slot screwdriver. Ensure the fuse cover is replaced before attempting to connect the plug to an electrical outlet.

If an extension lead is required, use an approved and compatible lead rated for this appliance. Follow all the instructions supplied with the extension lead.

†Double insulated : This product requires no earth connection as supplementary insulation is applied to the basic insulation to protect against electric shock in the event of failure of the basic insulation.

Important: If using an extension lead, follow the instructions that came with your lead regarding maximum load while cable is wound. If in doubt, ensure that the entire cable is unwound. Using a coiled extension lead will generate heat which could melt the lead and cause a fire.

4.6 Residual Risk

The safety instructions in this manual cannot account for all possible conditions and situations that may occur. Exercise common sense and caution when using this product and protect against any additional conceivable risks.

5. Identification and Unpacking

5.1 Product Overview

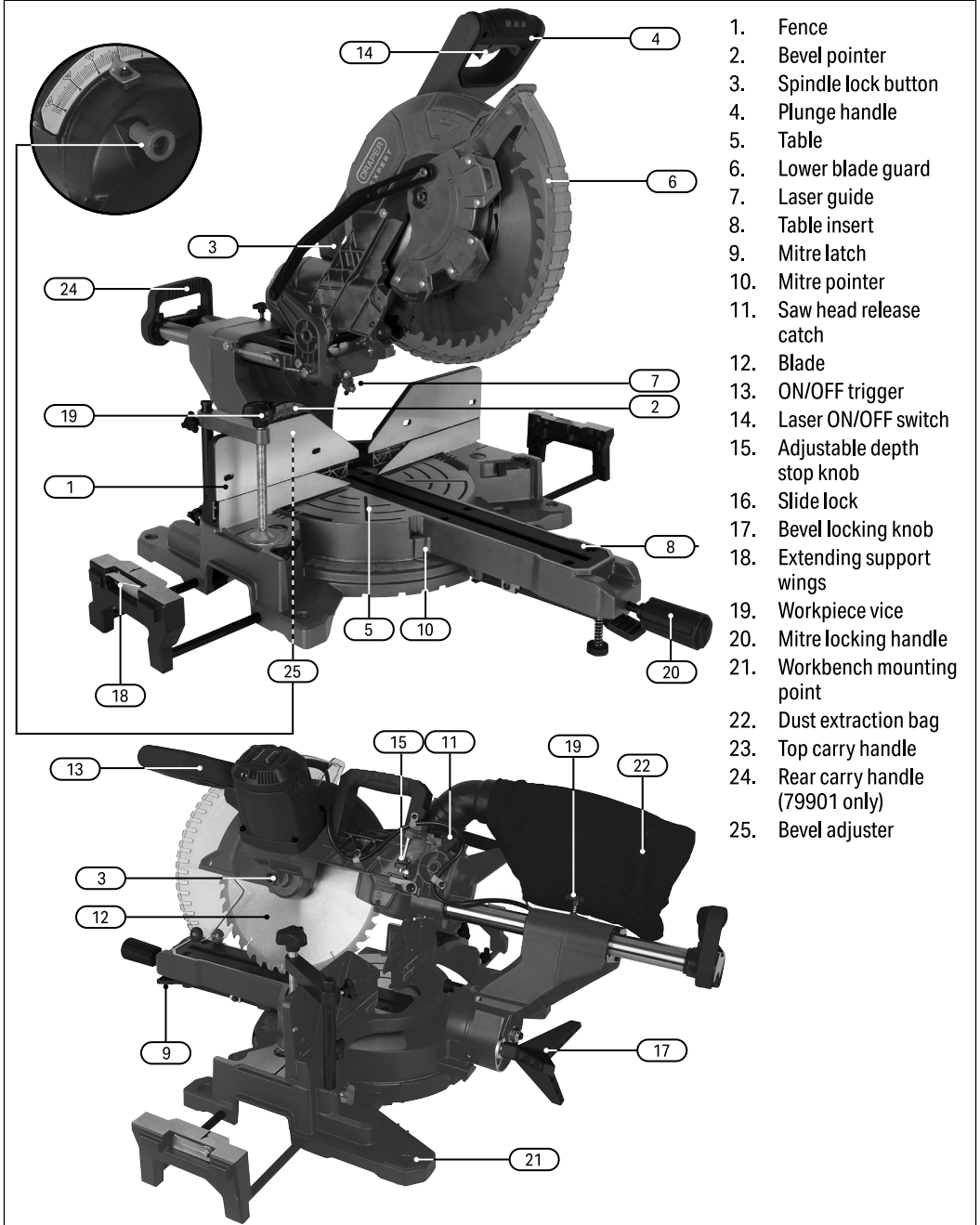

1. Fence
2. Bevel pointer
3. Spindle lock button
4. Plunge handle
5. Table
6. Lower blade guard
7. Laser guide
8. Table insert
9. Mitre latch
10. Mitre pointer
11. Saw head release catch
12. Blade
13. ON/OFF trigger
14. Laser ON/OFF switch
15. Adjustable depth stop knob
16. Slide lock
17. Bevel locking knob
18. Extending support wings
19. Workpiece vice
20. Mitre locking handle
21. Workbench mounting point
22. Dust extraction bag
23. Top carry handle
24. Rear carry handle (79901 only)
25. Bevel adjuster

5.2 What's in the Box?

Carefully remove the product from the packaging and examine it for any signs of damage that may have occurred during shipment.

Before assembling the product, lay the contents out and check them against the parts shown below. If any part is damaged or missing, do not attempt to use the product. Please contact the Draper Helpline; contact details can be found at the back of this manual.

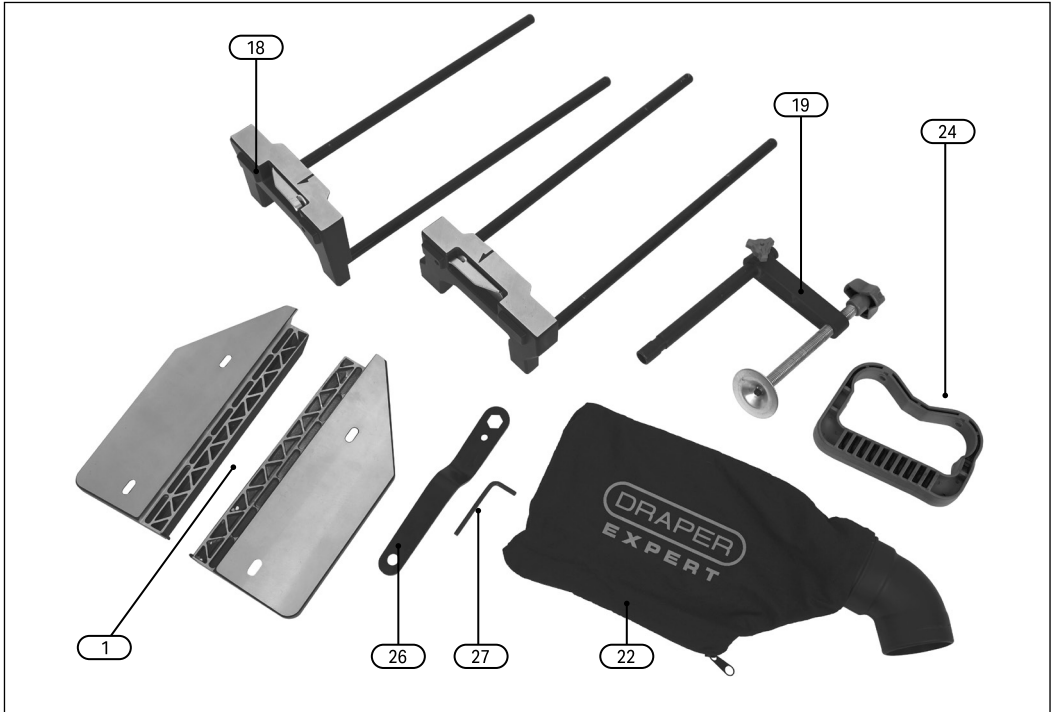

1. Fence

18. Extending support wings

19. Workpiece vice

22. Dust extraction bag

24. Rear carry handle
(79901 only)

26. Spanner

27. Hex. key

5.3 Packaging

Keep the product packaging for the duration of the warranty period for reference should the product need to be returned for repair.

WARNING! Keep packaging materials out of reach of children. Dispose of packaging correctly and responsibly and in accordance with local regulations.

Please visit drapertools.com for our full range of accessories and consumables.

6. Preparation Instructions

Important: Before preparing or adjusting this product, read and understand all the safety instructions listed in this manual. Unplug the tool from the power supply before carrying out any adjustments.

6.1 Transportation

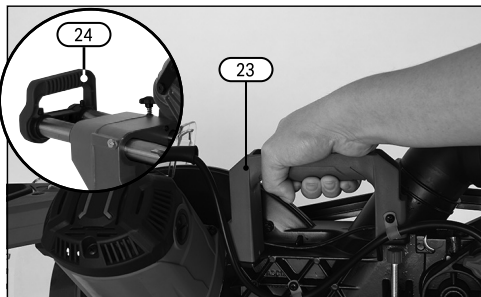

Fig. 1

- **ONLY** lift the mitre saw when the saw arm is locked in the down position and the saw is switched off and unplugged from the power supply.
- Lift the saw using the carrying handles (23) and (24) or by the outer casing.
- **DO NOT** use the guard or plunge handle (4) to lift the saw.

6.2 Saw Head Release Catch

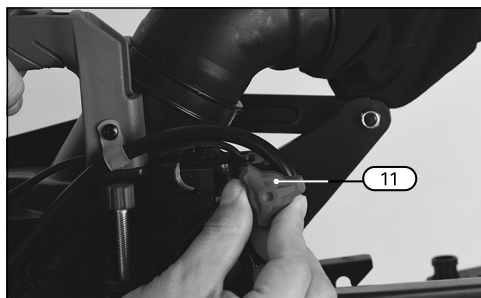

Fig. 2

- The release catch (11) is provided for holding the cutting head down while moving or storing the mitre saw.
- **NEVER** use the saw with the release catch locking the head down.
- **To use the release catch** – push the saw head down slightly and pull the release catch (11) out.

6.3 Slide Lock

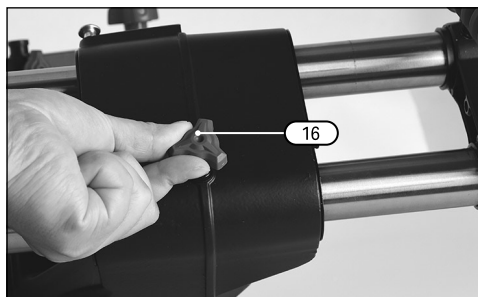

Fig. 3

- During transportation, tighten the slide lock (16) to prevent the saw head from sliding.

6.4 Bench Mounting

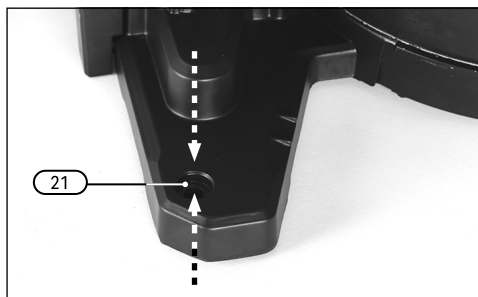

Fig. 4

NOTE: ALWAYS mount the saw on a secure and level surface. Use the predrilled holes (21) in the saw base to mount on a bench.

- Mount the saw to the bench using four suitable bolts (not supplied).
- The saw can be mounted to a piece of plywood at least 13mm thick, which can then be clamped to your work support or moved to other job sites and re-clamped.

⚠ CAUTION! Ensure the mounting surface is not warped as an uneven surface can cause binding and inaccurate sawing.

6.5 Workpiece Vice Assembly

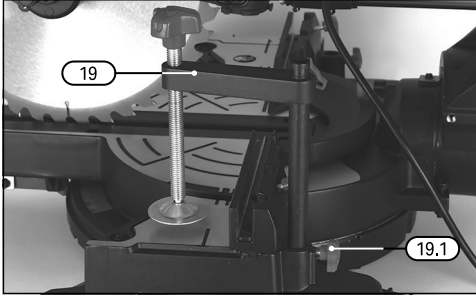

Fig. 5

- The vice assembly (19) can be mounted to the fence either side of the saw blade as required.
- Use the vice assembly lock (19.1) at the back of the fence (1) to secure the clamp in position.

6.6 Attaching the Extension Support Wings

- The extension wings (18) help to support the material when working with long workpieces.
- There are two location holes for a support bar on either side of the table.
- The end stop (18.1) can be secured in place or lowered out of the way when cutting longer lengths of wood.

To attach the extension wings: Stock No. 79889

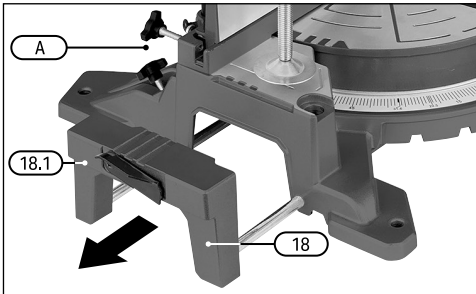

Fig. 6

- Loosen the side support locking knobs (A) on the back of the base at the bottom.
- Remove the four screws from the end of the bars.
- Then insert the bars fully into the base and replace the screws.
- Close the two knobs when the extension wings are at the required position.

To attach the extension wings: Stock No. 79801

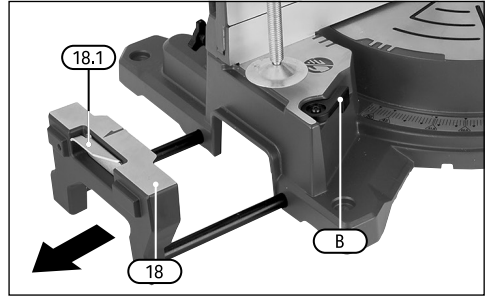

Fig. 7

- Open the two levers (B) at the front of the table.
- Remove the four screws from the end of the bars.
- Then insert the bars fully into the base and replace the screws.
- Close the two levers when the extension wings are at the required position.

6.7 Miter Table Lock

Use the miter table locking handle (20) to lock the table at the required mitre angle between 0° and 45°.

To adjust the mitre saw:

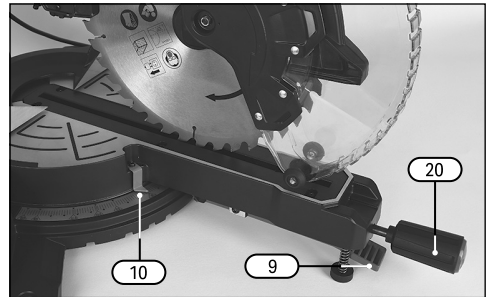

Fig. 8

- Loosen the mitre table locking handle (20) and press the sprung loaded mitre latch (9) to rotate the table.
- Use the mitre angle pointer (10) as a guide to rotate the table to the required angle. Then lock the table in place.
- The mitre table features positive click stops at 0°, 15°, 22.5°, 31.6° and 45° for quick setting of common mitre angles.
- To disengage the click stops, press the mitre latch and turn to the required angle.



WARNING! To avoid injury due to the table moving, ensure the mitre table locking handle is tighten before making a cut.

6.8 Bevel Lock

Use the bevel lock to set the blade at the required bevel angle between 0° and 45°.

To adjust the bevel angle:

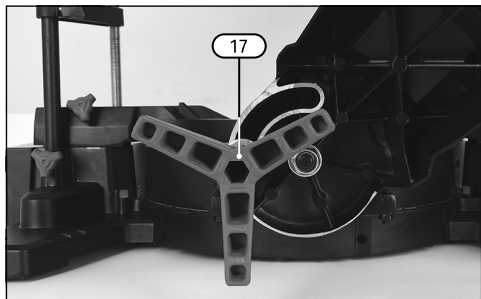

Fig. 9

- Loosen the bevel locking knob (17) and pull out the spring loaded bevel adjuster (25).

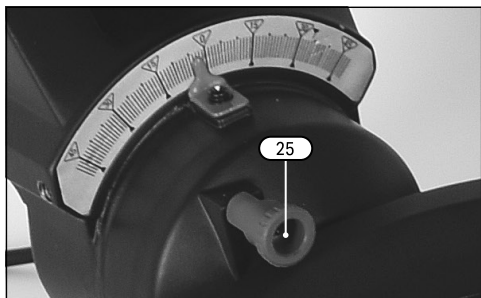

Fig. 10

- Adjust the saw arm to the required angle and re-tighten the bevel locking knob.

⚠ WARNING! To avoid injury due to the saw arm moving, ensure the mitre table lock is tightened before making a cut.

6.9 Setting the Fence square with the Table

Note: Ensure the saw is unplugged from the power supply.

1. Push the plunge handle (4) down to its lowest setting. Then engage the release catch (11) to hold the saw arm in the transport position.
2. Loosen the table locking handle (20).
3. Rotate the table until the pointer (10) is at 0°.
4. Tighten the table locking handle (20).

If the left and right hand upper fences are already attached to the base:



Fig. 11

5. Use the screw locks (1.1) to loosen the upper pieces of the fences (1). Remove these top sections.

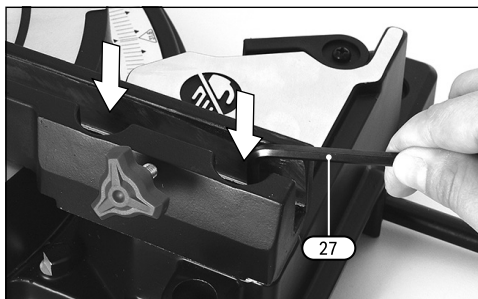

Fig. 12

6. Use the hex key (27) supplied to loosen the four bolts securing the fence to the base.



Fig. 13

7. Place a set square against the fence and alongside the blade. Ensure the square does not touch the blade teeth.
8. Adjust the lower fence until it is square with the blade.
9. Retighten the lower fence hex bolts.

10. Loosen the cross head screw holding the mitre scale pointer (10). Adjust it so that it accurately indicates the '0' position on the scale.
11. Replace the top sections of the fence and secure.

6.10 Setting the 90° Angle to the Blade

Important: Unplug the saw from the power supply before setting the blade angle.

1. Push the plunge handle (4) down to its lowest setting. Then engage the release catch (11) to hold the saw arm in the transport position.
2. Loosen the mitre locking handle (20).
3. Rotate the table until the pointer (10) is at 0°.
4. Tighten the mitre lock.
5. Loosen the bevel locking knob (17) and set the blade at 90° to the table.
6. Retighten the bevel locking knob.

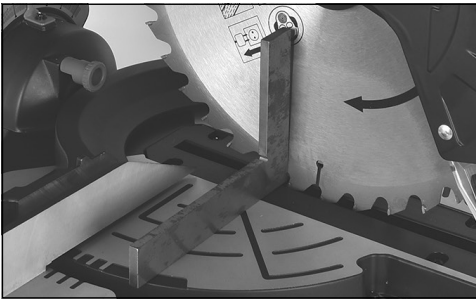

Fig. 14

7. Place a set square against the table and the flat part of the blade. Ensure that the square contacts the flat part of the blade and not the teeth.
 8. Rotate the blade by hand and check the blade to table alignment at several points.
- The edge of the set square and saw blade should be parallel.

If the saw blade angles away from the set square, adjust as follows:

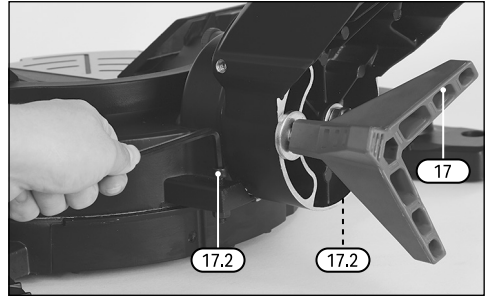

Fig. 15

- Loosen the bevel locking knob (17) – ensuring the bevel adjuster (25) is pushed in.

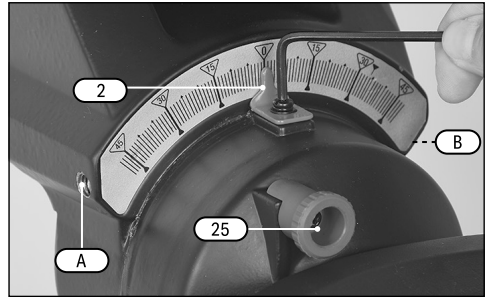

Fig. 16

- Insert a 4mm hex. key into the grub screw hole (A).
 - Turn clockwise to move the head to the left.
 - Turn anticlockwise to move the head to the right. Ensure pressure is applied to the head to retain it against the bevel stop.
- When the blade is flat against the set square remove the hex. key.

Stock No 79901 – has a stop at 33.5° for left side bevels:

- Loosen the bevel locking knob (17) – ensuring the bevel stop (25) is pushed in.
- Tilt the head to the left until it comes up against the stop.
- Use a protractor to check the angle between the table and the blade. Ensure the protractor does not touch the blade teeth.
- If adjustment is needed:
- Insert a 4mm hex. key into the grub screw hole (A).
 - Turn clockwise to move the head to the left.
 - Turn anticlockwise to move the head to the right.

6.11 Setting the 45° Bevel angle to the Blade

Important: Unplug the saw from the power supply before setting the blade angle.

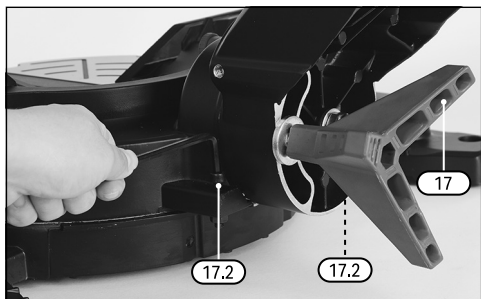

Fig. 17

1. Push the plunge handle (4) down to its lowest setting. Then engage the release catch (11) to hold the saw arm in the transport position.
2. Loosen the mitre locking handle (20).
3. Rotate the table until the pointer (10) is at 45°.
4. Tighten the mitre lock.
5. Loosen the bevel locking knob (17) and set the blade at 45° bevel to the left against the adjuster.
6. Place a set square against the table and the flat part of the blade. Ensure that the set square contacts the body of the blade and not the teeth.
7. If adjustment is required, use the spanner (26) supplied to loosen the lock nut on the stop bolt (17.2).
8. Use the hex. key (27) supplied to adjust the bolt to the correct angle. Then retighten the lock nut.
9. Check the right 45° bevel as above.

6.12 Laser Line

Note: The laser is factory set to the centre of the blade width.



WARNING!

- **DO NOT** stare directly at the laser beam.
- **NEVER** aim the laser beam at any person or an object other than the workpiece.
- **ALWAYS** aim the laser beam at a sturdy non-reflective workpiece such as wood or rough coated surfaces. Bright shiny reflective surfaces are not suitable for laser use as the beam could be directed back at the operator.

- **ALWAYS** switch off the laser (14) after finishing a job. **ONLY** turn the laser beam on when the workpiece is on the mitre saw table.

To use the Laser

- Mark the line of cut on the workpiece.
- Adjust the mitre and bevel angle of cut as required.

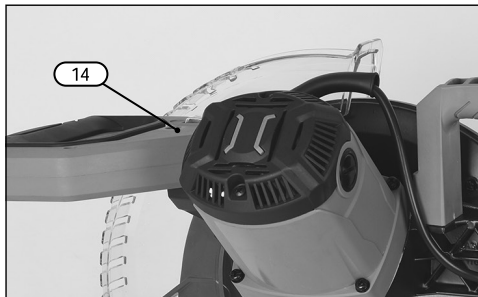

Fig. 18

- Turn on the laser light **ON/OFF** switch (14).



Fig. 19

- Clamp the workpiece in place using the laser line to align the blade with the pencil mark on the workpiece.
 - Make an allowance for the width of the blade.
- When the blade is at maximum speed (after approx. 2seconds) lower the blade through the workpiece.
- Switch off the laser light once cutting is complete.

7. Operating Instructions

Important: Before operating this product, read and understand all the safety instructions listed in this manual. Ensure that the product is fully assembled and correctly prepared for use.

7.1 Saw ON/OFF Trigger/Making a Cut

Note: The mitre saw is fitted with a safety switch to prevent accidental starting.

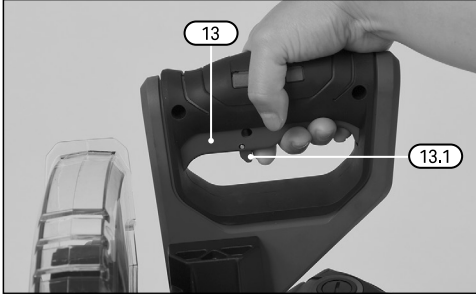

Fig. 20

1. Hold the plunge handle (4) and slide the lever (13.1) located in the centre of the **ON/OFF** trigger switch (13) to the left.
2. Squeeze the trigger (13) and allow the blade to reach maximum speed.
3. Slowly lower the blade into and through the workpiece.
4. Release the trigger switch and allow the saw blade to stop before lifting the blade out of the workpiece.

7.2 Adjusting Depth Stop

Note: The depth adjustment screw (15.1) is preset by the factory.

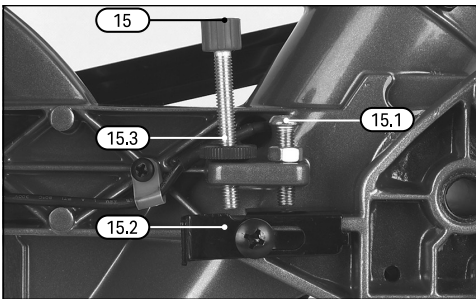

Fig. 21

- Ensure the depth stop (15.2) is pushed to the rear when the workpiece needs to be cut all the way through.
- If a different depth of cut is required, raise the head to the uppermost position. Pull the depth stop (15.2)

- forward, loosen the lock nut (15.3) and adjust the depth adjustment stop to the required position.
- Tighten the locking nut. Make a test cut to check the cut depth.
- To return to normal operation, move the depth stop to the rear.

Stock No 79901

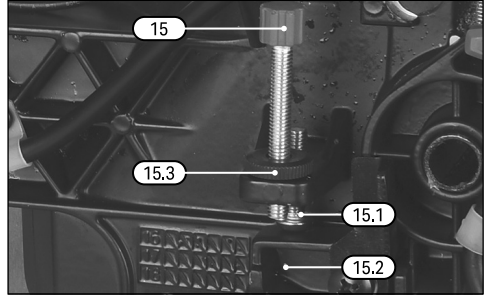

Fig. 22

- Set the same as for Stock No. 79899 except the depth stop (15.2) should be in the vertical position for normal use and horizontal for adjustable cut depths.

7.3 Dust Extraction



Fig. 23

- The saw is supplied with a dust extraction bag (22).
- Empty the bag regularly during use or when full.
- When cutting large pieces or cutting for a longer period, use a vacuum cleaner to allow for more efficient removal of airborne dust particles. An appropriate adaptor may be required to adjust the dust outlet size to fit the vacuum hose.
- A suitable dust mask must be worn for all cutting operations.

7.4 Mitre Cut

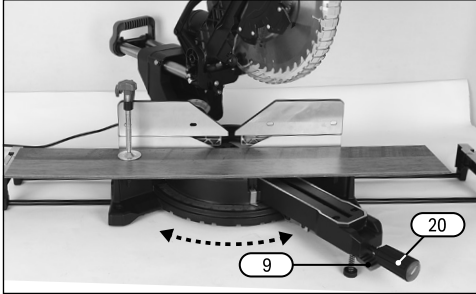

Fig. 24

- Loosen the mitre locking handle (20).
- Press in the mitre latch (9) and move the saw to the required angle.
- **DO NOT** stand in front of the saw table. Move with the handle to the mitre angle to make the cut.

7.5 Bevel Cut

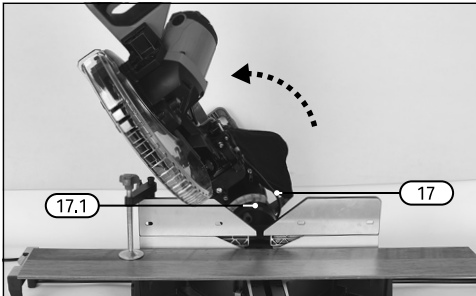

Fig. 25

- Loosen the bevel locking knob (17).
- Pull out the stop button (17.1) and tilt the saw head to the required angle. Tighten the bevel lock.
- Tilt the blade to the desired bevel angle.
- Stand to the left side of the handle to make the cut.

7.6 Compound Cut

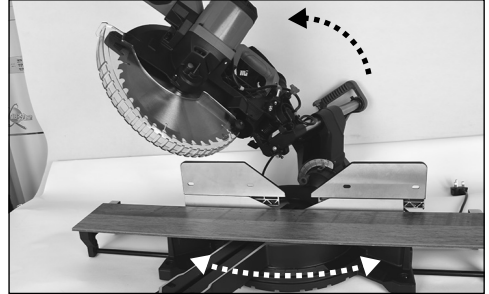

Fig. 26

- Select the correct bevel and mitre position.
- Move with the handle to the mitre angle to make the cut.

7.7 Cutting Curved or Warped Material

- Before cutting a workpiece ensure it is flat. If is curved or warped, position the workpiece as shown.
- **DO NOT** position the workpiece incorrectly or try to cut without the support of the fence. This will cause pinching of the workpiece on the blade.
- Take care as the workpiece could suddenly jump or move causing your hand to touch the blade.

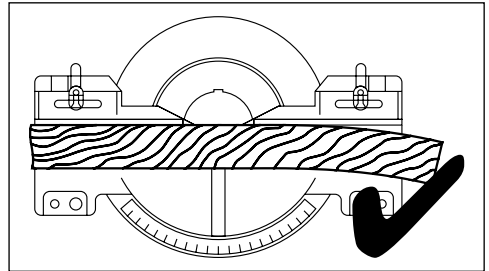

Fig. 27

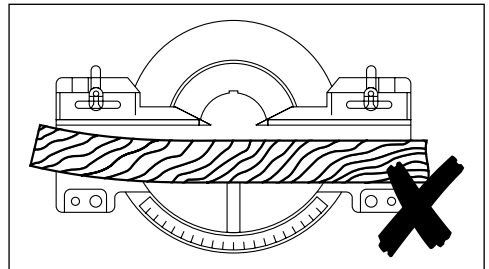
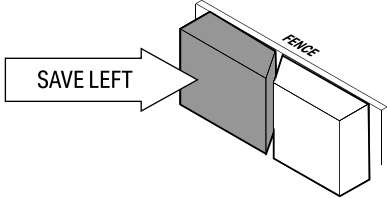

Fig. 28

7.8 Cutting Crown Mouldings

To cut an inside corner:

- Cut the left side by aligning the top of the moulding against the fence.
- Set the bevel to 33.9°.
- Set the mitre to 31.6° to the right hand side.
- Make the cut and save the piece to the left of the cut line.



To cut the left side:

- Align the bottom of the moulding against the fence.
- Set the bevel to 33.9°.
- Set the mitre to 31.6° to the left hand side.
- Make your cut and again save the piece to the left of the cut line.

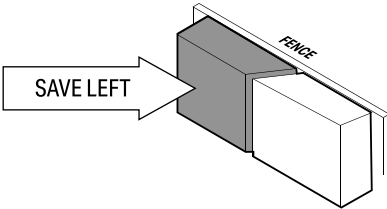

To cut an outside corner:

- Cut the left side by aligning the bottom of the moulding against the fence.
- Set the bevel to 33.9°.
- Set the mitre to 31.6° to the left hand side.
- Make the cut and save the piece to the right of the cut line.

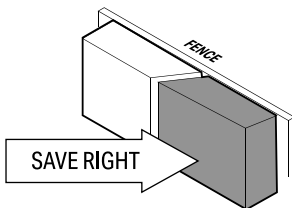

To cut the right side:

- Align the top of the moulding against the fence.
- Set the bevel to 33.9°.
- Set the mitre to 31.6° to the right hand side.
- Make your cut and again save the piece to the right of the cut line.

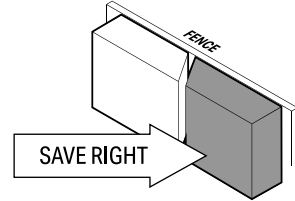

7.9 Workpiece Support

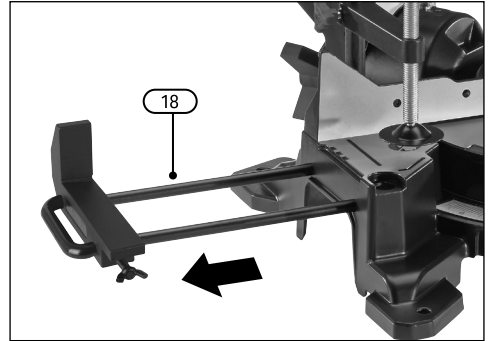

Fig. 29

- Long workpieces need extra support during cutting.
 - Place extra support under the workpiece so it does not sag and the hand holding the workpiece is positioned at least 10cm (4") from the path of the blade.
 - The support must allow the workpiece to lay flat on the machine table during the cutting operation.

8. Maintenance and Troubleshooting

Important: ALWAYS switch off and unplug the saw from the power supply before carrying out any adjustments, servicing or maintenance.

- If the power supply cord is damaged, it must be replaced by Draper Tools, an authorised service agent or similarly qualified personnel in order to avoid a hazard.

8.1 General Maintenance

- Regular inspection and cleaning reduces the necessity for maintenance operations and will keep your tool in good working condition.
- The motor must be correctly ventilated during tool operation. For this reason, avoid blocking the air inlets. After use disconnect the tool from the power supply and vacuum the ventilation slots.
- After use, wipe off chips and dust adhering to the tool with a cloth. Keep the blade guard clean. Lubricate the sliding portions with machine oil to prevent rust.
- To maintain product safety and reliability, repairs and any other maintenance or adjustment should be performed by your nearest authorised service centre.

WARNING! Never put lubricants on the blade whilst it is spinning.

WARNING! To avoid injury from unexpected starting or electrical shock, unplug the power cord before working on the saw.

WARNING! For your safety, this saw is double insulated. To avoid electrical shock, fire or injury, use only parts recommended by the manufacturer. Reassemble exactly as original assembly to avoid electrical hazards.

8.2 Cleaning the Laser Guide Assembly

- After every use clean the laser guide assembly (7):
 - Turn off the laser light switch (14) and unplug the saw from the power supply.
 - With the plunge handle (4) in the raised position, remove any sawdust build up using a soft brush.

8.3 Changing the blade

Important: Ensure the saw is unplugged before changing the blade.



WARNING!

- NEVER attempt to use a blade that is too thick to allow the outer blade washer to engage with the flats on the spindle.
- DO NOT use the saw to cut metal or masonry.

Installing the Blade

- Install the blade with the direction of rotation arrow matching the arrow direction on the blade guard.
- Raise the plunge handle (4) to its highest position.

Stock No 79889

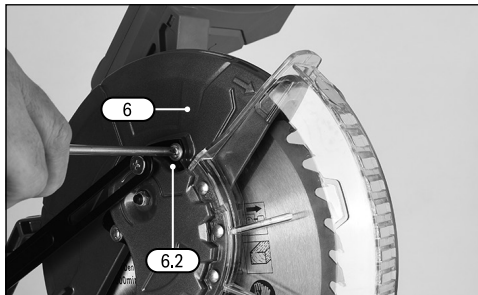

Fig. 30

- Loosen and remove the screw (6.2) from the lower guard pivot plate (6.1) using a cross-slot screwdriver.
- Turn the pivot plate anticlockwise while turning the lower guard anticlockwise.

Stock No 79901

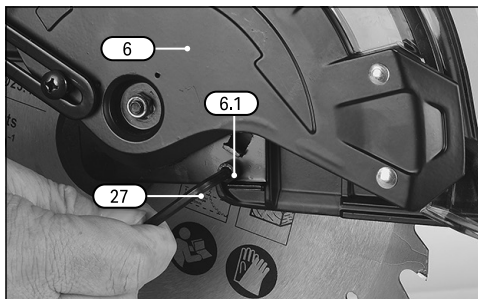

Fig. 31

- Turn the lower guard (6) to the open position.
- Loosen and remove the lower guard pivot plate screw (6.1) using the hex key (27) supplied.
- Turn the plate anticlockwise.

Both 79889 and 79901

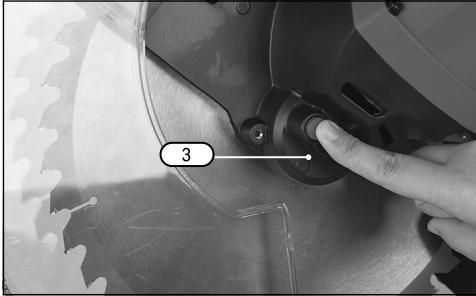

Fig. 32

- Press the spindle lock button (3) and turn the blade until the spindle locks.

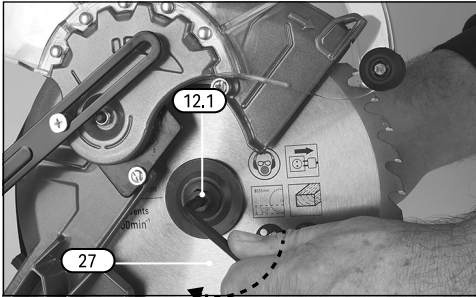

Fig. 33

- Loosen and remove the blade bolt (12.1) in a clockwise direction using the hex key (27) supplied.
- Remove the flat washer, outer blade washer and the blade.
- Wipe the inner and outer blade washer where they contact the blade with a drop of oil.
- Fit the new blade on the spindle ensuring that the inner blade washer sits behind the blade.

CAUTION! To ensure correct blade rotation, ALWAYS install the blade with the blade teeth and the printed arrow on the side of the blade pointing down.

- Replace the outer washer.
- Press in the spindle lock button (3) and replace the flat washer and blade bolt (12.1).
- Tighten the blade bolt in an anticlockwise direction securely.

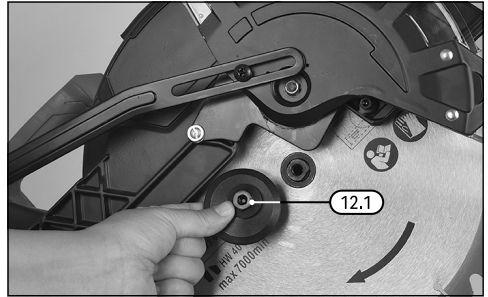

Fig. 34



Fig. 35

Stock No 79889

- Turn the lower guard pivot plate clockwise and refit the bolt.

Stock No 79901

- Turn the lower guard pivot plate clockwise and refit the bolt.
- Turn the lower blade guard clockwise to the closed position.

8.4 Blade Guard

- **DO NOT** use the saw without the lower guard fitted. The lower blade guard is attached to the saw for protection.
- If the lower guard become damaged, **DO NOT** use the saw until the damaged guard has been replaced.
- Regularly check to ensure the lower guard is working properly.
- With the power supply disconnected, clean the lower guard of any dust or build up with a damp cloth.

CAUTION! DO NOT use solvents on the guard. They could make the plastic 'cloudy' and brittle.

 **WARNING!** When cleaning lower guard, unplug the saw from the outlet to avoid unexpected start-up or electrical shock.

8.5 Sawdust Removal

- Frequently vacuum up the sawdust to prevent it accumulating around the worktable, base and switch mechanisms.

8.6 Recommended Accessories

 **WARNING!** To avoid injury from unsafe accessories, use only Draper accessories.

8.7 Prohibited Accessories

- **DO NOT** use accessories such as shaper cutters or dado sets. Ferrous and non-ferrous metal cutting and the use of abrasive wheels are prohibited.

8.8 Lubrication

- All the motor bearings in this tool are lubricated with enough high-grade lubricant for the life of the unit under normal operating conditions, therefore, no further lubrication is required.
- All the ball bearings are sealed and lubricated for life and will require no maintenance.

8.9 Troubleshooting

Problem	Possible Cause	Remedy
Motor does not start.	Plug fuse blown.	Check and replace fuse in plug.
	Brushes worn.	Have brushes replaced by an authorised service agent.
	Other issues.	Contact Draper tools for advice.
Sliding action stiff or binding.	Slide lock engaged.	Loosen slide lock.
	Build up of sawdust.	Vacuum up sawdust and lubricate mechanism.
Poor cutting performance	Saw blade blunt.	Stop saw immediately and replace blade.
	Saw blade incorrectly fitted.	Stop saw immediately and remove and refit blade.
	Incorrect saw blade selection.	Contact Draper tools for advice.
Saw Vibrates.	Saw blade distorted.	Stop saw immediately and replace blade.
	Saw blade incorrectly fitted.	Stop saw immediately and remove and refit blade.
Mitre position difficult to move.	Build up of sawdust under table.	Vacuum up sawdust.

9. Spares, Returns and Disposal

For spare parts, servicing, and repair and replacement options, please contact the Draper Tools Product Helpline for details of your nearest authorised agent.

Draper Tools will endeavour to hold any spare parts, if applicable, for seven years from the date that it sells the final matching stock item.

Any servicing or repairs carried out by unauthorised personnel or installation of spare parts not supplied by Draper Tools will invalidate your warranty.

At the end of its working life, dispose of the product responsibly and in line with local regulations. Recycle where possible.

- **DO NOT** dispose of this product with domestic waste; most local authorities provide appropriate recycling facilities.



0

10. Warranty

24 months from date of purchase.

Extended to 36 months on registration – Visit drapertools.com/warranty for full details.

However, if the tools are hired out, the warranty period is 90 days from the date of purchase.

This warranty does not cover consumable parts, normal wear & tear, damage, misuse, careless or unsafe handling, alterations, accidents or repairs attempted other than by authorised Draper warranty repair agent.

11. Explanation of Symbols



Read the instruction manual.



Mandatory action required.



Warning!



Kepp out of reach of children.



Warning! Class 2 laser product.



Warning! Class 2 laser product.



Wear face mask, safety glasses and ear defenders.



Wear protective gloves.



Rated voltage.



Rated input.



Blade diameter.



Bore diameter.



Revolutions per minute (no load).



EN Compliancy rating.



Cross Cut.



Mitre Cut.



Bevel Cut.



Compound Cut.



Class II construction (Double insulated).



Net product weight.



WEEE –

Waste Electrical & Electronic Equipment

Do not dispose of Waste Electrical & Electronic Equipment in with domestic rubbish



European conformity.



UK Conformity Assessed.

Contact Details

Draper Tools

Draper Tools Limited
Hursley Road
Chandler's Ford
Eastleigh
Hampshire
SO53 1YF
UK

Website: drapertools.com

Email: sales@drapertools.com

Product Helpline: +44 (0) 23 8049 4344

Telephone Sales Desk: +44 (0) 23 8049 4333

General Enquiries: +44 (0) 23 8026 6355

Draper Tools Europe B.V.

Oude Graaf 8
6002 NL
Weert
Netherlands

Please contact the Draper Tools Product Helpline for repair and servicing enquiries.