

12/24V

BATTERY CHARGER

52985 – BCD30A SPARE PARTS DRAWING/LISTING

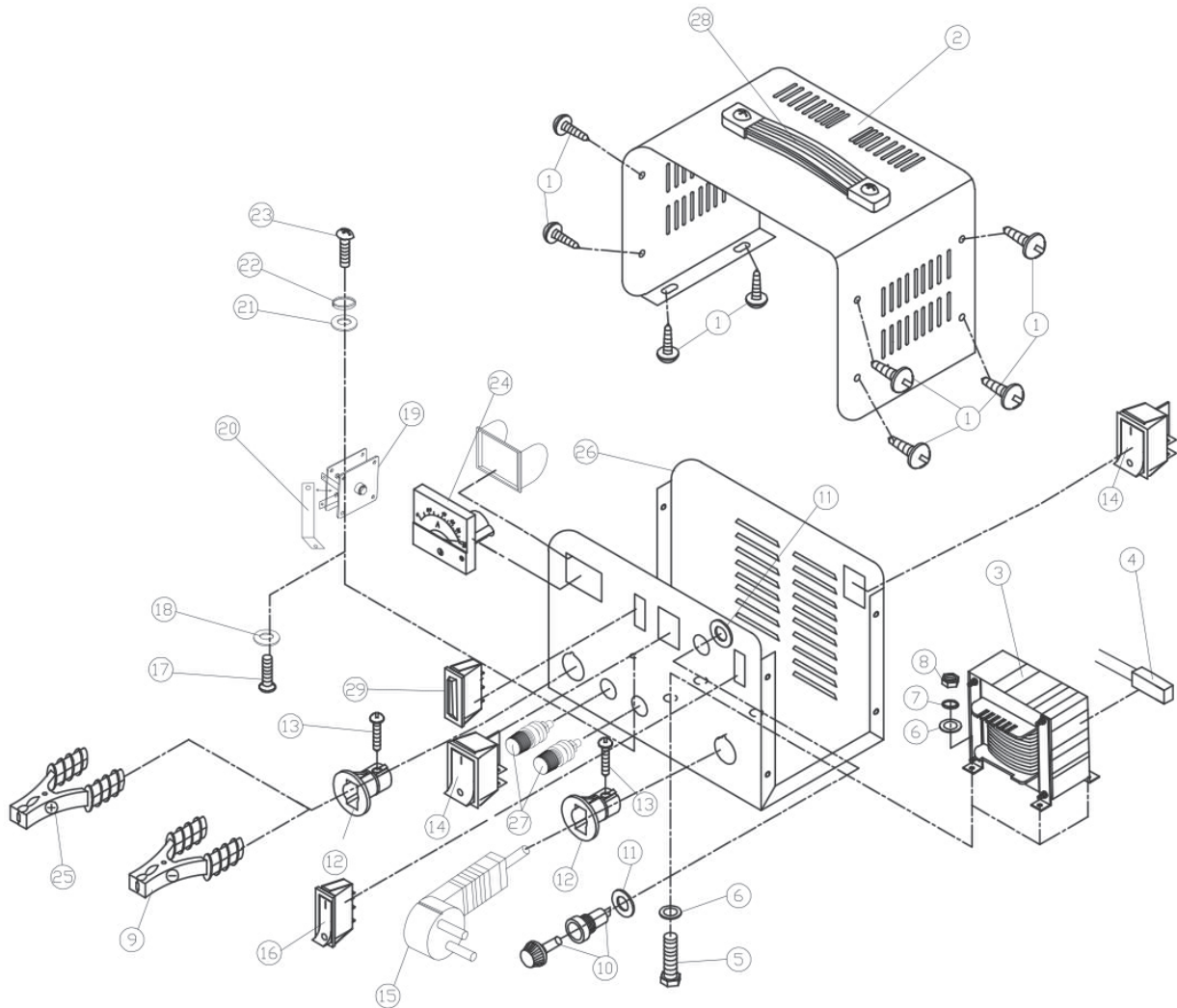

KEY No.	PART No.	STOCK No.	DESCRIPTION
1			(NP) M4.8*12 Self Tapping Screw
2			(NP) Machine Cover
3			(NP) Transformer
4			(NP) Temperature Controller
5			(NP) M5*20 Screw
6			(NP) Flat Gasket ø5
7			(NP) Spring Washer ø5
8			(NP) M5 Nut
9			(NP) Charging Clamp
10			(NP) Fuse Holder
11			(NP) Flat Gasket ø10
12			(NP) Fixed Parts
13			(NP) M3*16 Self Tapping Screw
14	YBCD18A-14	03159	Switch 30Amp (6 Pin)
15			(NP) Power Line

KEY No.	PART No.	STOCK No.	DESCRIPTION
16	YMAX-50-8	12147	Current Switch 20Amp (3 Pins)
17			(NP) M6*20 Screw
18			(NP) Flat Gasket ø6
19			(NP) Bridge Rectifier
20			(NP) Bracket
21			(NP) Flat Gasket ø6
22			(NP) Spring Washer ø6
23			(NP) M6*20 Screw
24	YBCD18A-24	03160	Amp Meter 30Amp
25	YMAX-50-17	12156	Charging Clamp
26			(NP) Base
27			(NP) Terminal
28			(NP) Handle
29	YBCD30A-29	03164	Fuse (30Amp)
30			(NP) Terminal
31	YBCD18A-31	03162	On/Off Switch