



UPS Solutions

EATON

Powering Business Worldwide

Contents



Powering Business Worldwide	4
... more sustainably	5
Powering electrical systems worldwide	6
Power Quality Business.....	8
Power protection for different needs.....	9
ABM Technology	10
Powerware Hot Sync Technology	12
ESS Technology.....	14
VMMS Technology	16
Eaton Protection Box	18
Eaton Protection Station.....	20
Eaton Ellipse ECO UPS.....	22
Eaton Ellipse MAX UPS	24
Eaton Evolution UPS.....	26
Eaton 5PX UPS	28
Eaton EX UPS	30
Eaton MX UPS.....	32
Eaton EX RT UPS.....	34
Eaton 9155 and 9355 UPS.....	36
Eaton 9355 UPS	38
Eaton BladeUPS	40
Eaton 9390 UPS	42
Eaton 9395 UPS	44
Eaton STS 16	46
Eaton FlexPDU, HotSwap MBP	48
Eaton ePDU	50
Intelligent Power Software	58
Connectivity.....	61
Eaton Enclosures.....	62
UPS Runtime Tables	64
UPS Runtime Tables	65

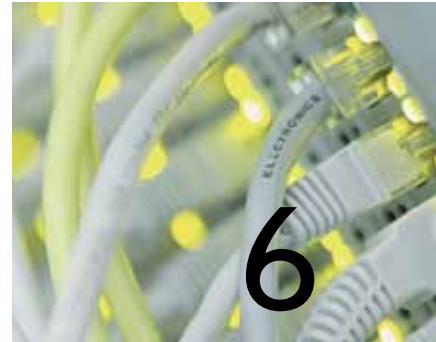



Aerospace



Truck



Powering business worldwide

Discover Eaton – a leader in the power management field

Since 1911, when our company began trading as a small truck parts supplier, Eaton® Corporation has come a long way. Today, as a diversified power management company, Eaton has sales of \$13.7 billion USD (FY 2010), employs 70,000 people and has customers in more than 150 countries. Everyday, we help companies across the world to manage power, and do more, while consuming less energy.

Eaton's innovative products, solutions and technologies are designed to help customers to manage power and conserve resources while working more productively, safely and sustainably. Our integrated and diversified business strategy ensures that we remain at the forefront of our industry, decade after decade.

Electrical

A global leader in electrical control, power distribution, uninterruptible power supply and industrial automation products and services. Our products provide customer-driven PowerChain Management® solutions to serve the power system needs of the industrial, institutional, government, utility, commercial, residential, IT, mission critical and OEM markets worldwide.

Aerospace

A leading global supplier to commercial and military aviation and aerospace industries. An extensive technology portfolio includes hydraulic systems, fuel systems, motion control systems, propulsion sub-systems, cockpit controls and displays and fluid health monitoring systems. Our products improve fuel economy, aircraft performance, reliability and safety.

Truck

A leader in the design, manufacture and marketing of complete line of drivetrain systems and components for medium- and heavy-duty commercial vehicles. Under the "Roadranger" brand, Eaton also markets lubricants, safety products and service tools. Eaton's hybrid power systems have earned the company recognition as a global leader in alternative power for commercial vehicles.

Automotive

A supplier of critical components that reduce emissions and fuel consumption and improve stability and performance of cars, light trucks and commercial vehicles. Principal products include engine valves and valve train components, transmission and engine controls, supercharger, locking and limited slip differentials, cylinder heads, fluid conveyance components, body mouldings and spoilers.

Hydraulics

A worldwide leader in reliable, high-efficiency hydraulic systems and components for use in mobile and industrial applications. Markets include agriculture, construction, mining, forestry, utility, material handling, earth moving, truck and bus, machine tools, moulding, primary metals, automotive, power generation, port machinery and entertainment.



Electrical



Automotive



Hydraulics

... more sustainably

Sustainability – smaller footprint in the world

The principle of sustainability means meeting the current needs of our own society without compromising the needs or options of future generations. It is a principle, which forms the very core of our design and production philosophy and guides all our activities across the world. Eaton commitment to reducing its own ecological footprint covers a wide range of green technologies, products and services that help customers utilise electrical power more efficiently, while improving environmental performance.

Green Leaf certification

Eaton has developed a rigorous internal environmental certification process called the Eaton Green Leaf based on the guidelines of major international standards bodies, such as the European Union, the US Federal Trade Commission and the International Organisation for Standardisation (ISO). Although all of Eaton's products and solutions are designed to meet or exceed government standards for protecting the environment, products and solutions with the Green Leaf designation go well beyond these standards to provide exceptional environmental benefit.



An Eaton Green Solution

When you see this symbol, you know the solution represents an Eaton benchmark for environmental performance.

Learn more about Eaton Green Solutions at www.eaton.com/greensolutions



Powering electrical systems worldwide

Eaton is a market-leader in electrical power distribution, power quality systems, industrial automation and control products and services. Our technology-driven solutions serve the mission-critical needs of the industrial, utility, commercial, residential and information technology markets.

Buildings

Residential, Healthcare, Education, Commercial offices, Retail, Public sector, Airports

- Electrical distribution solutions for safe and efficient power delivery
- Power quality systems for uptime and reliability
- Power metering and monitoring to add intelligence and save costs
- Industrial control products for HVAC applications

Information Technology

Data centers, Telecommunication, Networks, Computer rooms

- World's most efficient line of UPSs to reduce footprint and save energy
- Reliable power systems with inherent redundancy to improve availability
- Power metering and monitoring to diagnose problems and lower costs
- Local service and support for quick response



Industrial & Machinery

Manufacturing, Agriculture, Construction, Mining and Metals, Petrochemicals, Pharmaceuticals, Pulp and Paper, Material handling

- Electrical distribution equipment to deliver power throughout the enterprise
- Control & automation and power quality equipment for process control
- Power metering and monitoring to manage energy costs and uptime
- Power and motion control products to optimize productivity, reliability, safety and operator comfort

Energy & Utilities

Renewable energy: Solar, Wind, Hydropower-
Traditional energy: Oil, Gas,
Smart grid, Water and waste water

- Electrical balance of system and turnkey services for residential, utility and commercial solar installations
- Power distribution equipment, control components and system installations services
- Network power grid technology for intelligent data, lower costs and crew/public safety

Power Quality Business

Eaton's power quality business has more than 45 years of experience in designing and producing innovative power quality products. The result is an expansive portfolio of products, which help to protect our customer's business processes, critical applications and systems from all power problems and failures reliably and efficiently.



Eaton product and service range

- AC UPS from 350 VA up to 4400 kVA
- DC systems of all sizes
- A broad portfolio of rack-based power distribution units (ePDU®)
- Software and connectivity products for power management and remote control
- Technical support and maintenance
- Complete power quality solutions

Eaton products are manufactured in Finland, USA, China, Taiwan, India, Brazil, UK and New Zealand.

Power protection for different needs

There are nine common types of power problems, including power failure, power sag, power surge, undervoltage, overvoltage, switching transient, line noise, frequency variation and harmonic distortion. Based on three UPS topologies, Eaton offers a wide range of UPS solutions to provide an appropriate level of power protection against different power problems and failures.

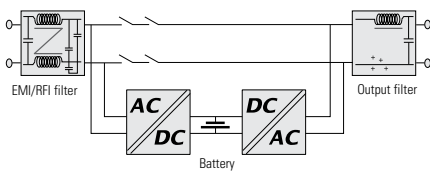

Passive standby topology (off-line) is the most frequently used UPS topology for protecting PCs against power failure, power sag and power surge. In normal mode, the UPS supplies power to the application directly from the mains, filtered but without active conversion. The battery is charged from the mains. In the event of a power cut or fluctuation, the UPS delivers stable power from the battery. The advantages of this topology are low cost and adequacy for office environments. Passive standby topology is not suitable if the power supply is of low quality (industrial sites) or subject to frequent disruptions.

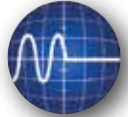

1. POWER FAILURE

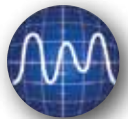

2. POWER SAG

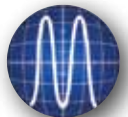

3. POWER SURGE



4. UNDERVOLTAGE

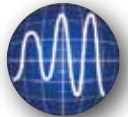

5. OVERVOLTAGE

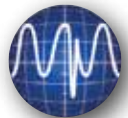

6. SWITCHING TRANSIENT

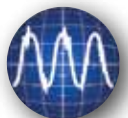

7. LINE NOISE

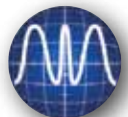

8. FREQUENCY VARIATION



9. HARMONIC DISTORTION

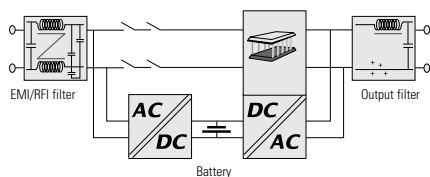

Line interactive topology is used for protecting enterprise networks and IT applications against power failure, power sag, power surge, undervoltage and overvoltage. In normal mode, the device is controlled by a microprocessor that monitors the quality of the supply and reacts to fluctuations. A voltage compensation circuit is enabled to boost or reduce the supply voltage to compensate for the fluctuations. The main advantage of this topology is that it enables compensation of under and overvoltage without using the batteries.

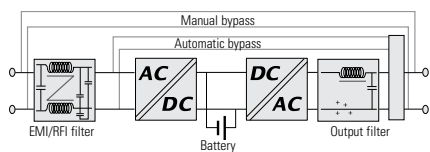

Double conversion topology (on-line) is a basis for UPSs designed for continuous power protection of critical equipment against all nine power problems: power failure, power sag, power surge, undervoltage, overvoltage, switching transient, line noise, frequency variation and harmonic distortion. It ensures a consistent quality of power supply regardless of disturbances in the incoming mains. The output voltage is entirely regenerated by a sequence of AC to DC conversion followed by DC to AC conversion in order to create power supply without any electrical interference. Double conversion UPSs can be used with any type of equipment as there are no transients when changing over to battery power.

ABM Technology



User benefits

- Predictive and automatic diagnostics of battery health
- Significant extension of battery life compared to traditional charging method
- Optimisation of battery recharging time with dual mode charging method
- Automatic battery charge voltage compensation within 0 to +50°C temperature range

Superior battery management

Battery service life is a major contributor to UPS reliability. Since batteries are electrochemical devices, their performance gradually decreases over time. Premature wear-out means higher costs in terms of replacement labour and shorter service cycle. A worn battery entails a risk of unexpected load loss. In normal UPS operation, backup power is needed only occasionally and the battery 'wearing' rate depends strongly on how the full charge is being maintained. Excess charging is detrimental under any operating circumstances.

Significant extension of battery life

Eaton has created ABM® technology to extend the life of valve-regulated lead-acid batteries by applying sophisticated logic to the charging regime. Using the traditional trickle charge method, batteries become subject to electrode corrosion and electrolyte dry-out, especially in standby service use due to continuous float charging. ABM is essentially an addition of intelligence to the charging routine by preventing unnecessary charging, thus significantly retarding wear-out. ABM provides an additional feature for monitoring battery condition and advance warning about the end of battery life upon detection of a weak battery. It also optimises the recharge time, which is advantageous when there may be consecutive power outages within a short period. ABM has been used for over 15 years in our UPSs ranging from 1 to 160 kVA and is now applied in UPSs up to 1100 kVA.

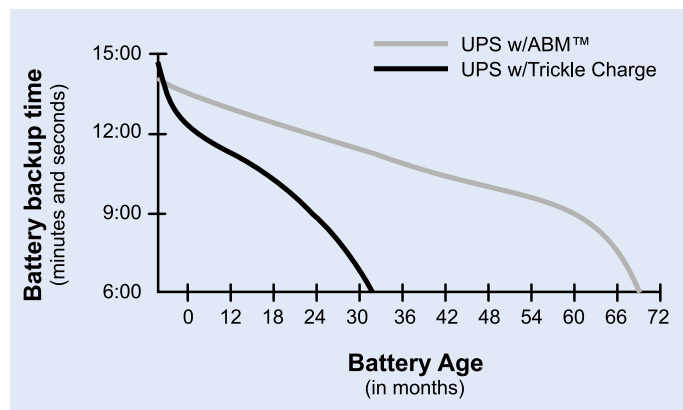

ABM technology significantly increases battery service life.

ABM Technology

ABM cycle and operation – how does it work?

The basic idea of ABM is to leave a fully charged battery in rest mode for most of the time, and then apply charge current only at certain intervals. Initially, in order to charge up a fully or partly discharged battery, the charger starts at a constant current appropriate for the battery type used. When the battery voltage reaches a set level, the operation is changed to float mode using a constant but lower voltage, thus providing an optimum recharge time. The battery is kept at this voltage for 24 hours until it comes to the first test point. This takes approximately one minute, and during this period voltage drop measurements are taken while loading the battery, giving an indication of battery condition. The float charging is continued for an additional 24 hours, plus a period equal to 1.5

times the constant current charging time, before the rest mode is initiated. At this point, charging is discontinued for a maximum of 28 days – as if the batteries were disconnected. During the first 10 days the battery voltage is continuously monitored, and if it drops below 2.1 V/cell, the ABM restarts in charge mode and the user gets a notification of improper battery operation. If it drops below this limit after the 10-day period, charging is resumed without an alarm being raised. In short, the algorithm uses three charging stages in its operation. Thus, the batteries experience much less stress than in the case of traditional charging. A typical battery charging cycle without power interruptions is shown in the graph below.

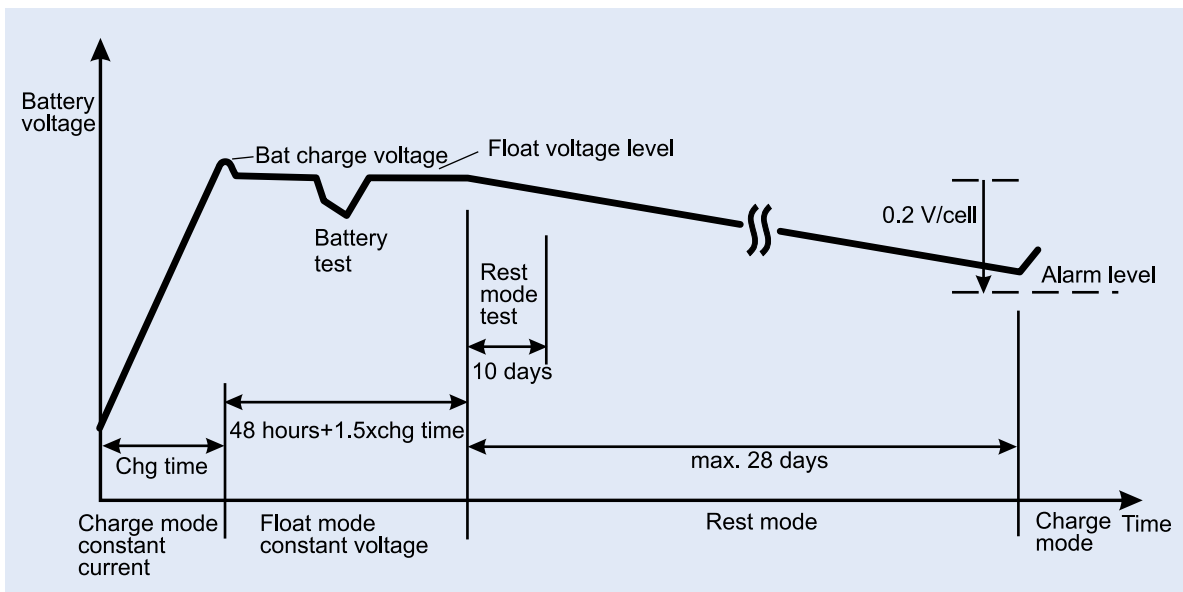

Battery voltage during one ABM charging cycle.

For convenience, the user has the facility to disable the ABM and instead select continuous 'constant voltage' charging whereby the charger uses a constant float voltage. 'ABM enabled' is the default setting. The charger voltage levels are (by default setting) programmed to be dependent on an internal temperature sen-

sor measurement, thus providing further enhancement to battery health. The external batteries can be also provided with temperature dependent charger voltage. For this purpose a Web/SNMP card with Environmental Monitoring Probe (EMP) is required.

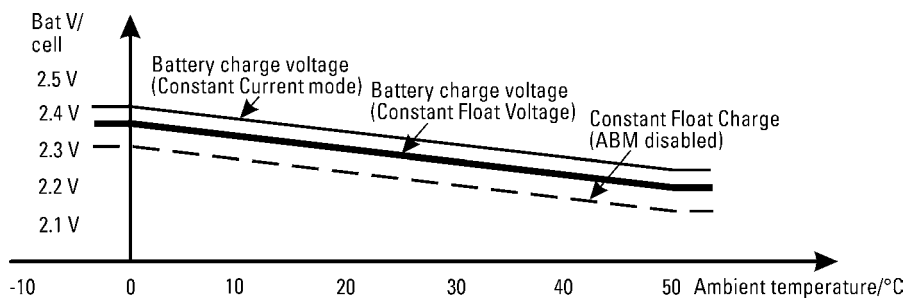

Temperature compensated charger between ±0°C...+50°C internal/external measurements.



Optional Web/SNMP card with EMP probe for temperature measurement of an external battery cabinet or rack.

Powerware Hot Sync Technology

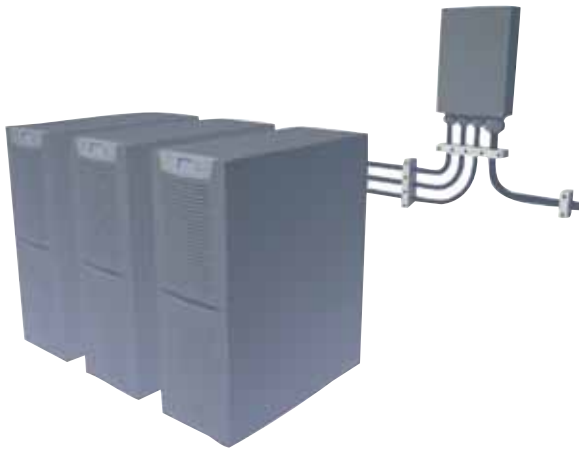

Paralleling UPS technology

The number one function of a UPS is to supply continuous conditioned, reliable electricity to a critical load. In case of a single unit, reliability can be increased by modular design, where redundant internal modules can take over each others' tasks, if one of the modules fails.

To further increase reliability, a true parallel configuration can be employed, where two or more units share the load. A failed unit is isolated while the remaining ones continue to support the critical load. Competitive UPS products on the market utilise centralised or distributed load-sharing technology with the master-slave principle, which introduces a risk of single point failure. The absolute reliability of a UPS system can be achieved with patented Powerware Hot Sync® parallel load-sharing technology. (Figure 1)

Hot Sync technology is designed for parallel redundant N+1 systems to satisfy 24/7 applications. It can also be used in parallel capacity systems to benefit from scalability for customers' ever-increasing load demands.

Hot Sync erases single point of failure, with an ability to synchronise and support critical loads independently of other UPS modules in the system. UPS modules can share loads without any communication wiring to the outside world.

User benefits

- Available for both single- and three -phase products to meet any mission-critical need up to 4.4 MVA (400V) systems
- Easy and modular parallel UPS system upgrade with additional capacity or redundancy
- Erases single point of failure

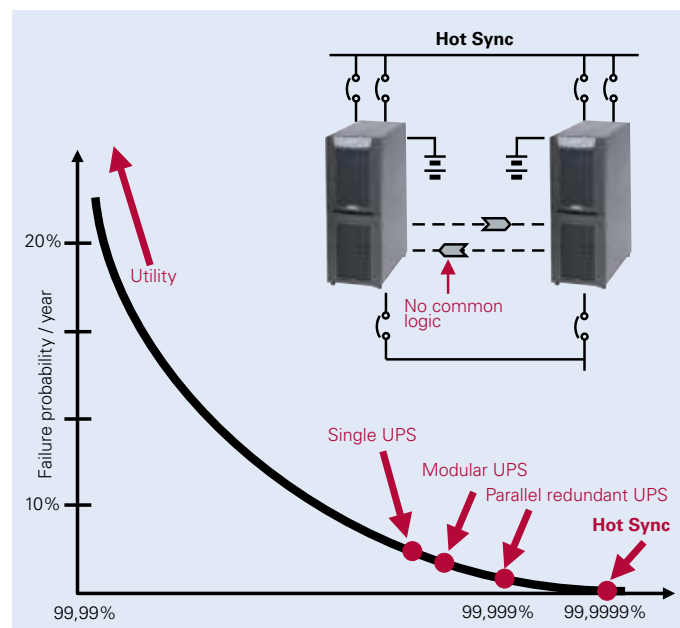

Figure 1. Power availability with various power supply configurations.

Powerware Hot Sync Technology

The secret here is a patented built-in digital signal processor (DSP) algorithm, running continuously in each unit. It drives the UPS outputs toward synchronisation and takes care of load sharing. If there is a common bypass available, it is used as valid synchronisation source for output. In the absence of a common bypass, the processor makes subtle adjustments to the inverter frequency on the basis of output power level measurement in order to find a common frequency and load balance among the units. There exists, as shown in Figure 2, a relationship between the power imbalance and the voltage phase difference.

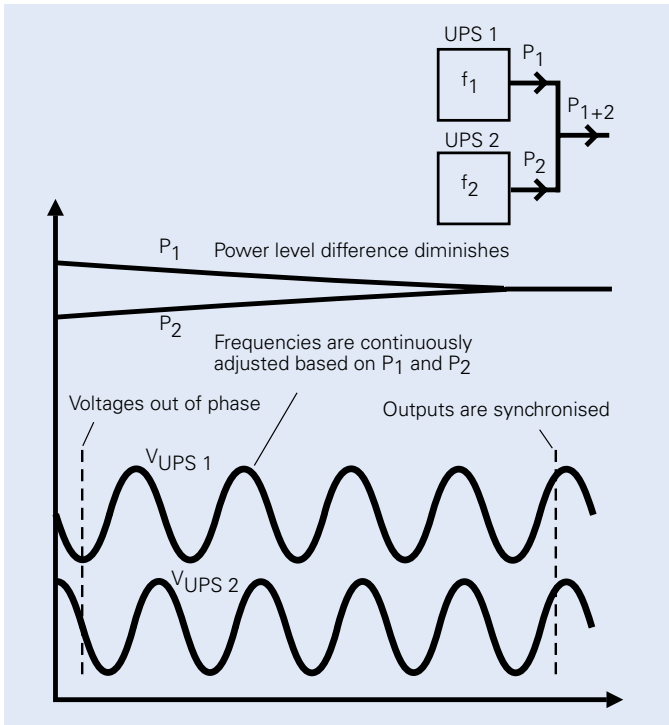

Figure 2. Well-balanced load share is achieved by adjusting output frequencies; thus the phase difference between parallel UPS output voltages is forced to zero.

The internal output impedance of a UPS is inherently mainly inductive, i.e. it looks as a small inductor in series with a stiff alternating voltage source. So, if there is any difference between the output voltage phases, it means that there is a power flow from unit to unit, resulting in unequal load sharing. In the Figure 3, two units have equal output voltages with phase angle displacement.

The voltage V_{diff} and current I_{diff} between units exhibit a 90 degrees phase shift due to the inductive source impedance. The main voltage (V_1 and V_2) and the current between units I_{diff} are in phase resulting in active power flow.

The greater the phase shift, the heavier the power imbalance. If we now introduce a controller to adjust the voltage phase by the output power, the phase difference can be forced to decrease. To adjust the phase difference to zero and to achieve accurate load sharing, we may integrate the measured phase thus arriving at power-controlled frequency. For the purpose of fast frequency locking and to enable synchronisation to external bypass, a term containing the power level change rate is added.

The flow diagram (Figure 4) shows how the load sharing proceeds.

The output power is monitored and the new frequency calculated at 3000 times per second. The measurements are also used for fast identification of a failed module. This feature is based on the computation of instantaneous output power. A negative value, even for a single instant, is an indication of an internal failure, e.g. a shorted inverter IGBT. In a response the UPS trips immediately off-line, causing minimal voltage disturbance. This feature is known as 'selective tripping'.

Hot Sync technology allows full maintenance to be performed one-by-one on redundant UPS modules without an external maintenance bypass switch. The critical load does not need to be disconnected from the conditioned power. Scheduled or unscheduled maintenance can be performed with the load supported continuously by the UPS-grade clean power.

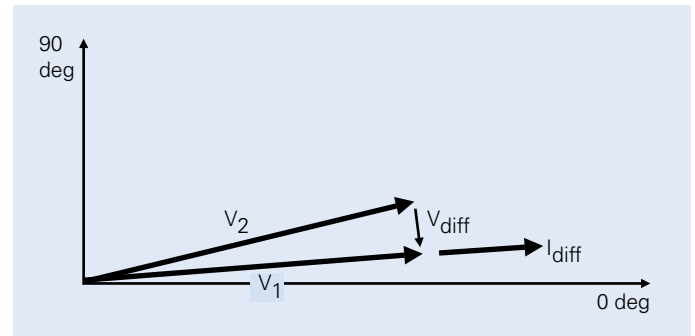

Figure 3. A phase displacement between parallel connected UPS voltages (V_1 and V_2) causes current flow between the units thus imbalances load share.

$$F_n = F_{n-1} - K_1(P_n) - K_2(\Delta P_n)$$

Where:

F_n = frequency

F_{n-1} = previous frequency

P_n = power to load

K_1 = frequency reduction factor

K_2 = power change rate factor

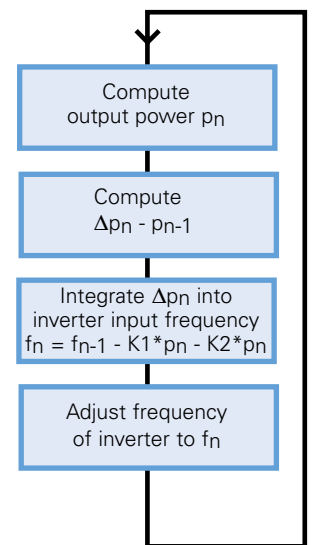

Figure 4. With HotSync algorithm, inverter phase angle is adjusted by output power and its change rate.

Accurate, equal load share is the number one characteristic to determine the integral quality and reliability of the parallel UPS system providing redundancy or increased capacity. With HotSync technology this is achieved without need for additional communications line between UPSs thus no single point of failure is added when introducing parallel modules to a system. From operational and also economical viewpoint, the achieved "close to perfect" reliability returns clear savings in the long run as every downtime incident is costly and might lead to unpredictable consequences.

Energy Saver System



Applications

Energy Saver System is available for all Eaton 9390 and 9395 UPSs including:

- stand-alone single UPSs
- parallel systems

All existing installations can be upgraded with the ESS capability.

Energy Advantage Architecture (EAA)

The rising demand for highly available, reliable and efficient power is a continuous challenge for data centre operators. Higher energy efficiency helps to address increasing environmental, regulatory and economic pressures.

Eaton has developed innovative and proprietary technologies that improve system efficiency without compromising on reliability under the Energy Advantage Architecture (EAA) umbrella.

Energy Saver System (ESS) is one of these technologies.

Maximised energy efficiency

With **85 percent reduction in UPS energy losses**, ESS technology dramatically reduces energy consumption, environmental impact and power costs without compromising load protection. With these outstanding energy savings, it is possible to recover the entire cost of the UPS over a three to five year period.

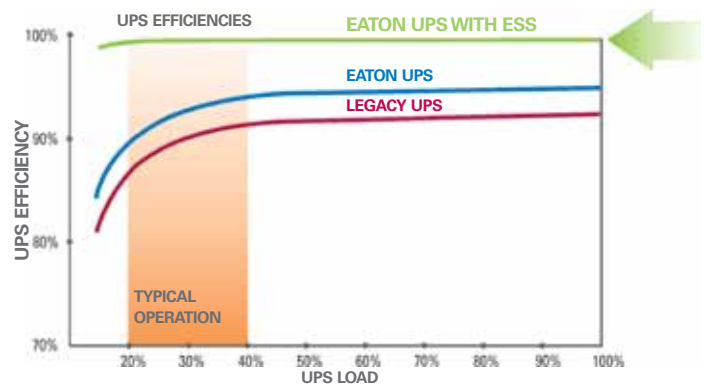

ESS enables market-leading 99 percent efficiency across the entire operating range. Compared to conventional 'eco-mode' capabilities available with legacy products, ESS offers the best possible efficiency and the fastest transition times to double conversion when power disturbances occur.

Energy Saver System

No compromise on reliability

In ESS mode the UPS safely provides mains current directly to the load when the input is within the acceptable limits by its voltage and frequency. If input power exceeds the predefined limits by frequency or voltage, the UPS switches to double conversion. If input power is outside the tolerances of the system, the UPS draws power from available battery modules.

Superior detection and control algorithms continuously monitor incoming power quality and allow the UPS to engage power converters in less than two milliseconds when the utility source exceeds predefined limits by its voltage or frequency, thus always providing secured power to the critical load while maximising efficiency. If the UPS detects a fault condition while operating in ESS, it is able to detect and determine whether the fault is caused by the load or if it is upstream from the UPS. A fault at the bypass source results in immediate switchover to the inverter; a fault in the load keeps the UPS in Energy Saver System (ESS).

Proven Eaton technology ensures reliability and continuous load availability without compromising the protection of the supported equipment.

Extensive configurability

Eaton UPS with Energy Saver System features three configurable modes of operation:

- Standard double conversion mode: the UPS operates as normal, supplying power through the power converters.
- Energy Saver System: the power converters are in ready state and the static bypass switch allows the UPS to supply mains power directly.
- High Alert mode: the UPS automatically transfers from ESS to double conversion mode and in case of multiple recurring utility line disturbances it stays there for a predefined time (default one hour) until it is safe to return to ESS.

The UPS seamlessly executes transitions through different operating modes as needed. This is only possible with transformer-free topologies.

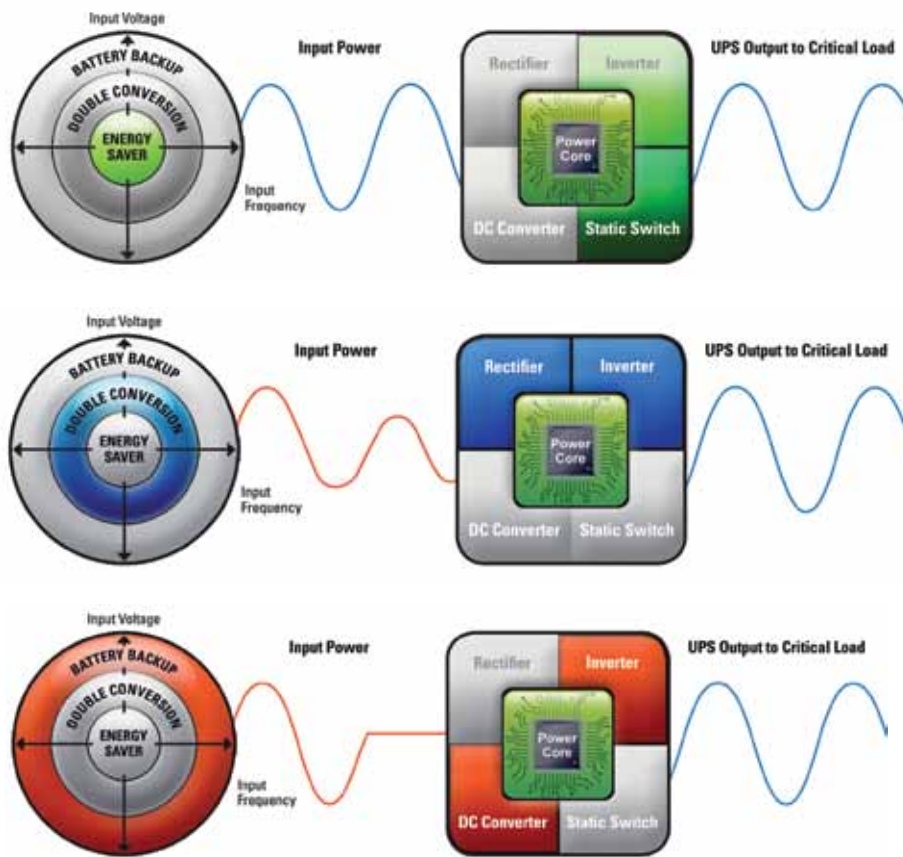

Active components engaged during Energy Saver System mode

Availability

ESS is available for all 9390 and 9395 UPSs. Parallel UPS systems also support operation in ESS mode. Existing installations can be upgraded with ESS capability.

Variable Module Management System



Applications

Typical applications where VMMS is particularly efficient include:

- UPSs in redundant N+1 and 2N systems
 - Lightly loaded: UPSs in these systems typically operate at low loads, < 45% load level
- Data centres, especially when the UPS system feeds dual-corded servers
- Any applications where load is not constant

Energy Advantage Architecture (EAA)

The rising demand for highly available, reliable and efficient power is a continuous challenge for data centre operators. Higher energy efficiency helps to address increasing environmental, regulatory and economic pressures.

Eaton has developed innovative and proprietary technologies that improve system efficiency without compromising on reliability under the Energy Advantage Architecture (EAA) umbrella.

Typical field operations are usually within low load range, but UPSs do not operate at optimal efficiency when used for lighter loads.

In some multi-UPS parallel systems used with lighter loads, the system maximises the load percentage of the UPSs by putting the UPSs that are not needed to power the load into idle mode. This results in partial energy savings and is limited to multi-UPS systems, with no efficiency improvements for single-UPS systems.

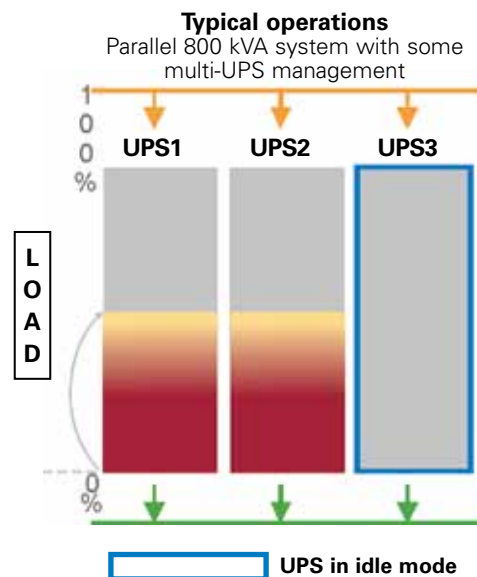

Variable Module Management System (VMMS) technology maximises efficiencies at lighter loads without compromising reliability.

Variable Module Management System (VMMS)

Maximised energy efficiency

VMMS optimally employs uninterruptible power modules (UPMs) in the UPS to achieve higher efficiencies in double conversion mode in order to maximise the percentage load level of the remaining active UPMs by switching UPMs that are not needed to ready state*.

This is calculated according to the UPMs' VMMS load threshold – 80% by default – and the system configuration (redundancy requirements). This results in maximised energy savings.

VMMS is only possible thanks to Eaton 9395 UPS modularity. VMMS can also be applied in multimodule single-UPS systems.

**In "ready state," the UPM rectifies the DC-link, generates logic level PWM (Pulse Width Modulation) signals and filters EMI and lightning spikes.*

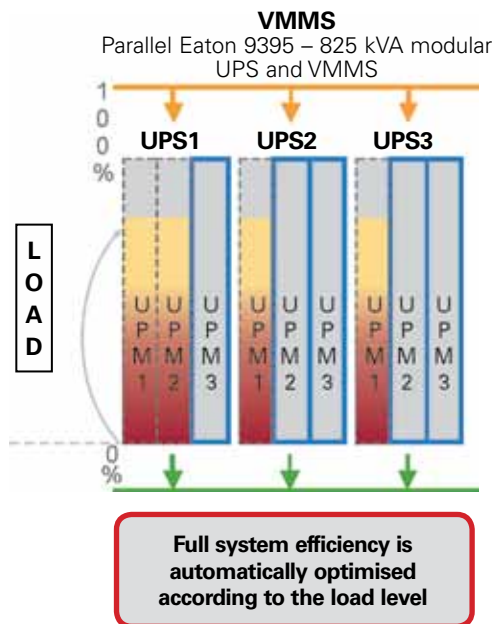

No compromise on reliability

When a disturbance or load increase occurs on a critical bus, all the UPMs in ready state are able to react quickly, immediately switching back to double conversion mode connecting the existing PWM signals to the IGBT gates.

In VMMS, all UPMs will switch to double conversion if:

- the output voltage fluctuates by more than 3% for any reason
- any UPM reaches its current limit or discharges its battery
- battery recharge is necessary.

Once the above conditions are resolved, the system switches back to VMMS, after a customer-preset time delay (1 to 60 hours): once the load stabilises, Eaton proprietary design and algorithms allow the system to determine which UPMs to switch back to ready state to maximise efficiency according to the new operating conditions.

Extensive configurability

Customers can decide how to configure their system, establishing the number of redundant UPMs and the max percentage load level per UPM allowed in VMMS setting other UPM's in ready state.

VMMS can be used in all multi-module (multiple-UPM) 9395 systems:

- Single 9395 units from 550kVA to 1100kVA
- Distributed parallel systems (Xx550, Xx825, Xx1100)
- SBM system

Existing installations can also be upgraded with VMMS capability:

- VMMS maintains redundancy and achieves higher efficiency by intelligently controlling the load levels of UPMs
- Number of redundant UPMs can be selected (N+0, N+1, N+2, N+X)
- UPMs in ready state can be used as redundant units (N+0)

Data centre with dual-corded servers, 825 (3x275) kVA UPS on A and B side – 440 kVA load

UPS configuration	Without VMMS	VMMS on N + 1 redundancy	VMMS on N + 0 redundancy
Efficiency @ 440 kVA load	91.2%	92.8%	94.3%
UPS energy savings	Used as reference for savings calculation	56 MWh / year	108 MWh / year
Additional benefits & comments	✓ Industry-leading UPS efficiency in double conversion	✓ Additional energy savings from reduced cooling in VMMS (typically 30-40% on top of UPS energy savings) ✓ UPMs in VMMS ready state available for redundancy	

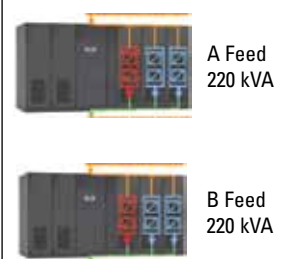
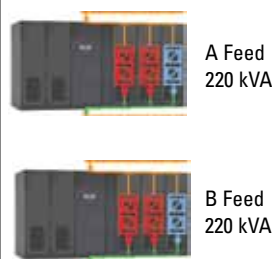
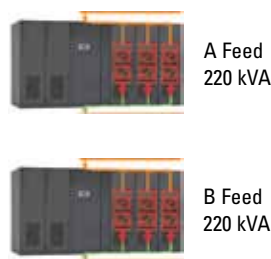

Eaton Protection Box



Eaton Protection Box 8



Eaton Protection Box 5



Eaton Protection Box 1

Advanced protection for:

- Computers, peripherals and multimedia
- TV, Video and Hi-Fi equipment: Home cinema, DVD writers, digital decoders, etc.
- Broadband modems (Internet and TV)
- IP telephony
- Household goods, etc.



Surge protection

The Eaton Protection Box multi-way block with high performance surge protection is a simple solution for protecting delicate equipment.

Effective surge protection

The Protection Box is designed to filter the power supply for delicate equipment to protect it against surges, interference and the indirect effects of lightning.

The high performance of the Protection Box is based on an advanced design with surge protection in compliance with IEC 61643-1.

Complete protection

The Protection Box range has models with 1, 5 or 8 sockets. Some models also provide protection for telephone connections that can carry surges to the equipment.

- Tel@ models: with telephone/broadband Internet access protection
- Tel@ + TV models: with telephone/broadband Internet access protection + Audio/Video protection module (surge protection for television and FM radio with TV and F-Type connectors)

Practical and economical: replaceable surge protection module

(Protection Box 5Tel@, 5Tel@ + TV and 8Tel@ + TV)

The surge protective components for these models are grouped into a pluggable module for:

- Easy replacement if the surge protective devices are destroyed by a major surge (no need to disconnect the equipment and the pluggable unit is an Eaton standard replacement part)
- Can be updated (adding functions, changing connectors, etc.)

Warranty for connected equipment

Eaton offers free warranty for the equipment connected (applicable for EU countries and Norway only). This insurance is included in the purchase price of the Protection Box and covers up to 50 000 € for an 8 socket model to cover damage caused by a failure of the surge protection.

And lots of features to simplify life

- Power ON and active protection indicators
- PowerLine Communications compatibility (Protection Box 5/8) for connecting PLC adapters
- Cable ties and cable markers supplied (5 and 8 socket models)
- Sockets arranged to allow blocks to be plugged side by side



Eaton Protection Box

- 1 Power ON indicator
- 2 Active protection indicator
- 3 Telephone / broadband protection
- 4 Replaceable surge protection module



Eaton Protection Box 8



Eaton Protection Box 5

- 5 Widely spaced sockets for transformer units, 1 PLC-ready outlet (for Protection Box 5 and 8)
- 6 All outlets with safety shutters



Audio/Video protection module available (for Protection Box 5 Tel@ + TV and 8 Tel@ + TV only)

TECHNICAL SPECIFICATIONS	1	1 Tel@	5	5 Tel@	5 Tel@+TV	8 Tel@+TV
Rating (A/W)*	16 A / 3 680 W	16 A / 3 680 W	10 A / 2 300 W	10 A / 2 300 W	10 A / 2 300 W	10 A / 2 300 W
Voltage/frequency	220 V – 250 V / 50/60 Hz					
IEC 61643-1 tested	Yes	Yes	Yes	Yes	Yes	Yes
PowerLine compatibility	/	/	Yes	Yes	Yes	Yes
Surge test conditions						
Surge test conditions for IEC 61643-1 with 8/20µs pulse	Uoc = 6.6 kV - Up = 1.5 kV - In = 2.5 kA - Imax = 8 kA					
Protective devices						
Total rating	30 000 A, 3 x MOV 10 000 A					
Response time	<1ns					
Total power absorbed	1110 Joules					
EMI/RFI filter						
52dB from 100kHz to 100MHz	/	Yes	/	Yes	Yes	Yes
Telephone and audio/video line protection						
RJ11/RJ45 telephone including broadband	/	10 000 A	/	10 000 A	10 000 A	10 000 A
Audio/Video line	/	/	/	/	10 000 A	10 000 A
Marking and standards						
Safety	IEC 60-950, NFC 61-303					
EMC	EN 55082-2, EN 55022 class B, EN 61000-4-4 level 4 IEC 61000-4-5, level X=10kV					
Surge protection	IEC 61 643-1					
Dimensions and weight						
Dimensions H x W x D	67 x 70 x 105 mm	67 x 70 x 105 mm	65 x 120 x 255 mm	65 x 120 x 260 mm	65 x 120 x 260 mm	65 x 150 x 315 mm
Weight	0.160 kg	0.210 kg	0.610 kg	0.770 kg	0.840 kg	0.850 kg
Customer Service & Support						
2 years warranty	Standard product exchange ; warranty for connected equipment up to 50 000 €					
Replaceable surge protection module	Standard exchange free of charge from Eaton aftersales services					

Part Numbers	1	1 Tel@	5	5 Tel@	5 Tel@+TV	8 Tel@+TV
French sockets (FR)	66 706	66 707	66 710	66 711	66 934	66 935
"Schuko" sockets (DIN)	66 708	66 709	66 712	66 713	66 936	66 937
French sockets (FR-B) for Belgium	/	/	66 932	66 933	66 938	/



FR DIN



Eaton Protection Station

500/650/800 VA



Eaton Protection Station 800



Multi-position



Advanced protection for:

- Home computing
- Digital leisure equipment



Combined UPS/surge protection/ multiple socket device

Innovative solutions offering total protection for home computers and digital leisure devices.

Connect all your equipment and protect them against power failures and voltage fluctuations...

Eaton Protection Station can do this, offering in a single device:

- Up to 8 standard outlets
- A high performance surge suppressor
- A UPS with 20 to 30 minutes battery back-up for a typical PC

The first UPS in this class with energy saving features

Eaton Protection Station boasts an efficient electrical design with **EcoControl function** that **automatically disables peripherals** when the master device (Computer, HD TV, Home network storage, etc...) is turned off. This will help you **save up to 30% energy** compared to previous generation UPSs.

One model suitable for each application

3 versions (500 VA/250 W, 650 VA/400 W or 800 VA/500 W backup power), to protect an internet PC, a multimedia computer with peripherals or a hardcore gamer configuration. Thanks to its multi-position format Eaton Protection Station can fit anywhere.

Guarantees total peace of mind

- Surge suppressor compatible with IEC 61 643-1 standard (+ status indicator)
- USB port and power management software as standard (650 & 800 models)
- Data line protection to ensure that the internet line (including xDSL) is protected against surges
- Unlimited warranty for the connected computer equipment (EU countries and Norway)
- Periodic test and battery replacement indicator



Eaton Protection Station



- 1 Surge protection status indicator
- 2 Line protection for telephone/Internet ADSL
- 3 Spaced outlets, compatible with local standards
- 4a Outlets with surge protection
- 4b Outlets with surge protection and back-up power
- 4c 2 EcoControl outlets (650 & 800)

- 4d 1 PLC-ready outlet
- 5 Replaceable batterie
- 6 Reset button (circuit breaker)
- 7 USB port (650 & 800) with Windows/Linux/Mac software
- 8 Indicator for mains/battery operation, overload, fault + audible alarms

Eaton Protection Station 650 & 800

TECHNICAL SPECIFICATIONS	500	650	800
Technology	High frequency UPS with surge protection		
Application			
Outlets	6 standard outlets (3 with back-up power and surge protection + 3 with surge protection)	8 standard outlets (4 with back-up power and surge protection + 4 with surge protection)	
Performance			
Output power capacity (backup outlets)	500 VA - 250 W	650 VA - 400 W	800 VA - 500 W
Output power capacity (all outlets)	5 A - 1150 VA	10 A - 2300 VA	10 A - 2300 VA
Input voltage range	184 V - 264 V	Up to 160 V - 284 V (adjustable)	Up to 160 V - 284 V (adjustable)
Output voltage and frequency	230 V - 50 / 60 Hz auto-selection		
Protection	Resettable circuit breaker		
Batteries			
Battery type	Replaceable sealed lead-acid batteries		
Battery monitoring	Automatic battery test, battery replacement indicator, protection against deep discharges (4-hour limit)		
Battery operation	Cold-start capable (mobile power source), battery charging even in OFF position		
Typical application	1 internet computer	1 multimedia computer + peripherals	1 computer high graphics power
Backup time with typical application	20 min	30 min	30 min
Features			
User interface	Operation with mains/battery power, surge suppressor status, overload, battery replacement, fault, audible alarms		
EcoControl	/	Save up to 30% energy* (efficient electrical design and automatic deactivation of idle peripherals)	
Surge protection	Complete common and differential mode protection - 3 MOV – Total power: 525 Joules, compatible with IEC 61643-1 standard		
Performance on 8/20 wave	Uoc = 6 kV Up = 1.5 kV In = 2.5 kA I max = 8 kA	Uoc = 6 kV Up = 1.7 kV In = 2.8 kA I max = 8 kA	Uoc = 6 kV Up = 1.7 kV In = 2.8 kA I max = 8 kA
PowerLine compatibility	/	1 PLC-ready outlet	1 PLC-ready outlet
Data line protection	Protection for telephone/fax/modem/Internet ADSL line + Ethernet network		
Installation	Requires earth connection		
Standards			
Standards	IEC 62040-1-1, IEC 62040-2, IEC 61643-1, Marquage CE		
Quality and environment	ISO 9001, ISO14001		
Dimensions and weight			
Dimensions W x H x D	155 x 304 x 137 mm	185 x 327 x 149 mm	185 x 327 x 149 mm
Weight	2.9 kg	3.8 kg	4 kg
Power Management			
Com port	/	USB port	USB port
Software	/	Personal Solution-Pac software on CD, compatible with Windows Vista/XP/Mac/Linux (power management, Automatic system shutdown, Alarm notification, Events log)	
Customer service & support			
2 years guarantee	Standard product exchange, including the battery ; warranty for the connected computing equipment for an unlimited amount (EU countries)		
Warranty+	Optional 3 years warranty (depending on the country please visit www.eaton.com/powerquality)		

*compared to UPS from the previous generations

Part Numbers	500	650	800
FR outlets	66 942	61 061	61 081
DIN outlets	66 943	61 062	61 082



FR DIN



An Eaton Green Solution



Eaton Ellipse ECO UPS

500/650/800/1200/1600 VA



Eaton Ellipse ECO range



Eaton Ellipse ECO easy integration



Energy-efficient power protection for business computers

- With an efficient electrical design and the EcoControl function (USB models), which automatically disables peripherals when the master device is turned off, the Eaton Ellipse ECO helps you make energy savings of up to 25 per cent compared to previous-generation UPSs.
- As well as providing a power supply backed up by a battery to keep equipment operating during a power failure, the Ellipse ECO also provides effective protection against damaging surges.
- The Ellipse ECO includes a high performance surge-protection device that complies with IEC 61643-1; this device also protects data connections such as Ethernet, internet and telephone lines.

Easy integration and installation

- The Ellipse ECO comes with either four (500/650/800 models) or eight outlets (1200/1600 models) with Schuko (DIN) or French (FR) format for easy connection to typical computer configurations with peripherals. IEC models are also available.
- The Ellipse ECO's extra-flat design makes it easy to install in any office environment: installation options include vertical box format, below the desk, horizontally under a monitor, 19" rack-mounted (optional 2U kit) and wall-mounted (optional kit).
- The USB models are designed to be compatible with a wide variety of different computer models. Eaton power management software is delivered as standard (CD and USB cable supplied) and is compatible with all major operating systems (Windows 7, Vista, XP, Linux and Mac OS).

Complete peace of mind

- Unlimited warranty for the connected computer equipment (EU countries and Norway)
- Periodic battery self-test ensures early detection of a battery that needs to be replaced.
- Easy-to-replace battery helps to extend UPS service life.
- Push-button circuit breaker enables easy recovery from an overload or short circuit.

Eaton Ellipse ECO

- 1 4 outlets with surge protection and backup
- 2 4 outlets with surge protection
- 2a 2 EcoControl outlets (1200 & 1600)
- 3 Tel/Internet and Ethernet protection
- 4 USB port
- 5 Replaceable batteries
- 6 Circuit breaker reset button



Eaton Ellipse ECO 1200/1600



Eaton Ellipse ECO 500/650/800

- 1 3 outlets with surge protection and backup , 1 socket with surge protection only
- 1a 1 EcoControl outlet (USB models)
- 2 Tel/Internet and Ethernet protection
- 3 USB port (USB models)
- 4 Replaceable batteries
- 5 Circuit breaker reset button

TECHNICAL SPECIFICATIONS	500	650	650 USB	800 USB	1200 USB	1600 USB
Rating (VA/W)	500 VA / 300 W	650 VA / 400 W	650 VA / 400 W	800 VA / 500 W	1200 VA / 750 W	1600 VA / 1000 W
Application						
Number of outlets	4	4	4	4	8	8
Outlets with surge protection and backup / Outlets with surge protection	3/1	3/1	3/1	3/1	4/4	4/4
Characteristics						
Nominal input voltage	230 V					
Input voltage	184 V - 264 V (adjustable to 161 V - 284 V)					
Output voltage	230 V (adjustable to 220 V, 230 V, 240 V)					
Frequency	50-60 Hz autoselect					
Input protection	Resettable circuit breaker					
Features						
Energy efficient design	Yes	Yes	Yes	Yes	Yes	Yes
EcoControl function	-	-	Yes up to 20% energy saving* (automatic deactivation of idle peripherals)		Yes up to 25% energy saving*	
Surge protection	Surge protection device compliant with IEC 61643-1					
PowerLine compatibility	-	-	1 PLC-ready outlet	1 PLC-ready outlet	1 PLC-ready outlet	1 PLC-ready outlet
Battery						
Battery type	Replaceable sealed lead acid					
Automatic battery test	Yes	Yes	Yes	Yes	Yes	Yes
Cold start (start without mains)	Yes	Yes	Yes	Yes	Yes	Yes
Deep discharge protection	4 hours	4 hours	4 hours	4 hours	4 hours	4 hours
Battery replacement indicators	LED + audible alarm					
Battery runtime at 50% load	9 min	9 min	9 min	11 min	10 min	11 min
Battery runtime at 70% load	5 min	6 min	6 min	6 min	6 min	6 min
Communication						
Communication port	-	-	USB port (cable supplied)	USB port (cable supplied)	USB port (cable supplied)	USB port (cable supplied)
Software	-	-	Eaton Intelligent Power software delivered as standard (compatible with: Windows 7/Vista/XP, Mac OS X, Linux)			
Line protection	Tel/Fax/Modem/Internet and Ethernet					
Standards						
Safety / EMC	IEC 62040-1, IEC 60950-1, IEC 62040-2, CB Report, CE mark					
Surge protection	IEC 61643-1					
Dimensions and weight						
Dimensions H x W x D	263 x 81 x 235 mm	263 x 81 x 235 mm	263 x 81 x 235 mm	263 x 81 x 235 mm	305 x 81 x 312 mm	305 x 81 x 312 mm
Weight	2.9 kg	3.6 kg	3.6 kg	4.1 kg	6.7 kg	7.8 kg
Customer Service & Support						
2 years warranty	Standard product exchange, including the battery ; warranty for the connected computing equipment for an unlimited amount (EU countries)					
Warranty+	Optional 3-years warranty (depending on the country please visit www.eaton.com/powerquality)					

* compared to previous generation UPS.

Part Numbers	500	650	650 USB	800 USB	1200 USB	1600 USB
French outlets (FR)	EL500FR	EL650FR	EL650USBFR	EL800USBFR	EL1200USBFR	EL1600USBFR
Schuko outlets (DIN)	EL500DIN	EL650DIN	EL650USBIN	EL800USBIN	EL1200USBIN	EL1600USBIN
IEC outlets	EL500IEC	EL650IEC	EL650USBIEC	EL800USBIEC	EL1200USBIEC	EL1600USBIEC
Accessories						
19" rack mounting kit (2U)	ELRACK	ELRACK	ELRACK	ELRACK	ELRACK	ELRACK
Wall mounting kit	ELWALL	ELWALL	ELWALL	ELWALL	ELWALL	ELWALL



FR DIN IEC



Eaton Ellipse MAX UPS

600/850/1100/1500 VA



Eaton Ellipse MAX range



Eaton Ellipse MAX versatility

Advanced protection for:

- Workstation
- Small servers
- Office equipment



Line interactive

Power protection for workstations and small servers

Availability

- **Line Interactive technology:** Eaton Ellipse MAX provides effective protection, even in disturbed electrical environments. Fluctuations in voltage are automatically corrected by an AVR device (booster/fader), without using the batteries. UPSs not only provide a battery backed up supply to keep equipment operating when there is a power cut but also provide effective protection against damaging surges.
- **Surge protection:** Eaton Ellipse MAX includes a high performance surge protective device which complies with IEC 616431 standard.
- **Robust:** A wide tolerance of input voltage avoids excessively frequent changeover to battery power. This means that maximum capacity is always available. The thresholds for changeover to battery power can be adjusted using the supplied Solution-Pac software.

Value

- **Easy installation:** Eaton Ellipse MAX USBs models are supplied with power management software & communication cables
- **Unlimited warranty:** Eaton Ellipse MAX provides a warranty of connected computer equipment for an unlimited amount

Flexibility

- **Connection:** 4 or 8 standard outlets for each country (FR, DIN or UNlversal), IEC version also available
- **Integration:** Eaton Ellipse MAX can be installed in vertical position over & under the desk, or horizontally under a monitor
- **Rackable:** the optional 2U kit allows you to install the Eaton Ellipse MAX in a 19" rack
- **Power management:** the USBs models feature a combined USB and serial port



Eaton Ellipse MAX

- 1 4 sockets with surge protection
- 2 4 sockets with surge protection and backup
- 3 Internet and Ethernet protection
- 4 Combined USB / serial port
- 5 Replaceable batteries
- 6 Circuit breaker reset button



Eaton Ellipse MAX 1500



Eaton Ellipse MAX 600

- 1 Combined USB/serial port (USBS models)
- 2 Tel/broadband and Ethernet 10/100 MB protection
- 3 Replaceable batteries
- 4 3 sockets with surge protection and backup and 1 socket with surge protection
- 5 Circuit breaker reset button

TECHNICAL SPECIFICATIONS	600	600 USBS	850 USBS	1100 USBS	1500 USBS
Rating (VA/W)	600 VA / 360 W	600 VA / 360 W	850 VA / 550 W	1100 VA / 660 W	1500 VA / 900 W
Technology	Line-Interactive High Frequency (Automatic Voltage Regulation)				
Connections					
Multi-way sockets: French, Schuko, Universal, IEC	4	4	8	8	8
Sockets with surge protection and backup / Sockets with surge protection for peripherals	3/1	3/1	4/4	4/4	4/4
Characteristics					
Input voltage	165 V - 285 V (adjustable to 150 V - 285 V)				
Output voltage	230 V (adjustable to 220 V - 230 V - 240 V)				
Frequency	50-60 Hz autoselect				
Surge protection	Integral surge protection device to IEC 61643-1, Total surge absorption: 525 Joules				
Circuit breaker	With reset				
Battery					
Replaceable battery	Compact sealed lead acid				
Battery charger	Operates when the UPS is under power				
Battery management	Battery test, Cold start (no mains), Deep discharge protection				
Battery replacement indicators	LED + audible alarm				
Typical backup times for 50 and 70% of the VA rating	12/7 min	12/7 min	18/12 min	15/9 min	12/7 min
Communication					
Communications port	/	Combined USB and serial port			
Software supplied as standard	/	Compatible with: Windows Vista/XP/2003/2000/98/NT, Mandrake Linux, Mandriva Linux, Red Hat Linux, Suse Novell, Debian GNU/Linux, Mac OS X			
Line protection	Tel/Fax/Modem/Internet et Ethernet 10/100 MB				
Standards					
Safety	IEC/EN 62040-1-1, CB Report, CE mark				
EMC	IEC / EN 62040-2 C1				
Surge protection	IEC 61643-1				
Mounting, Dimensions and Weight					
Dimensions H x W x D	314 x 82 x 301 mm	314 x 82 x 301 mm	314 x 82 x 410 mm	314 x 82 x 410 mm	314 x 82 x 410 mm
Weight	5.75 kg	5.75 kg	10.2 kg	10.2 kg	10.2 kg
19" rack mounting kit	2U	2U	2U	2U	2U
Customer Service & Support					
2 years warranty	Standard product exchange, including the battery ; warranty for the connected computing equipment for an unlimited amount (EU countries)				
Warranty+	Optional 3-years warranty (depending on the country please visit www.eaton.com/powerquality)				

Part Numbers	600	600 USBS	850 USBS	1100 USBS	1500 USBS
French sockets (FR)	68 541	68 545	68 549	68 553	68 557
Schuko sockets (DIN)	68 542	68 546	68 550	68 554	68 558
UNI sockets	68 543	68 547	68 551	68 555	68 559
IEC sockets	68 544	68 548	68 552	68 556	68 560
Accessories					
19" rack mounting kit	68 561	68 561	68 561	68 561	68 561



FR DIN UNI IEC



Eaton Evolution UPS

650/850/1150/1550 VA



1U rack model & tower model

Advanced protection for:

- Rack servers
- Tower servers
- Network devices
- Storage systems



Line interactive

High density protection for network devices

Maximum availability

- **Powershare:** the Eaton Evolution output sockets are individually controlled to provide load-shedding to maximise the backup time and provide remote reboot and sequential start-up as standard
- **Continuous power supply:** Hot swappable batteries. The optional HotSwap MBP (Maintenance By-Pass) module allows the UPS to be replaced without interrupting the power supply
- **Pure sinewave output:** when operating in batterie mode the Eaton Evolution still provides high quality output signal for sensitive connected equipment

Minimum total cost of ownership

- **Line-interactive HF technology:** the best price/performance ratio
- **No additional cost:** rack 1U models are provided with the rail kits
- **Remote supervision:** a wide range of options using the Eaton Software suite, including point-to-point power management, SNMP, relay outputs, etc...

Total flexibility

Evolution has unmatched Flexibility.

- **Format:** Evolution is available in tower or rack 1U format
- **Communication:** the Evolution includes both serial and USB ports, plus remote On/Off connector and an extra slot for optional communication cards. The UPS comes with a complete Eaton software suite.

Eaton Evolution UPS

- 1 Full user interface:
 - ON/OFF button for UPS and outlets
 - Load protected/ not protected LED
 - Utilised power level/Battery charge level
 - Status of switchable outlets
- 2 Panel for batteries replacement (Hot swappable)



- 3 1 USB port + 1 serial port + remote ON/OFF
- 4 4 IEC 10A sockets, including 2 programmable sockets
- 5 Communication card slot

Eaton Evolution 1550 Tower

TECHNICAL SPECIFICATIONS	650	850	1150	1550
Rating (VA/W)	650 VA / 420 W	850 VA / 600 W	1150 VA / 770 W	1550 VA / 1100 W
Format	Tower or 1U Rack	Tower or 1U Rack	Tower or 1U Rack	Tower or 1U Rack
Electrical characteristics				
Technology	Line-Interactive High Frequency (Booster + Fader)			
Input voltage and frequency ranges without using batteries	160V-294V (adjustable to 150V-294V) 47 to 70 Hz (50 Hz system), 56.5 to 70 Hz (60 Hz system), up to 40 Hz in low-sensitivity mode (programmable using Personal Solution-Pac software).			
Output voltage and frequency	230 V (+6/-10 %) (Adjustable to 200 V (10 % derating of output power) / 208 V / 220 V / 230 V / 240 V), 50/60 Hz +/- 0.1 %			
Connections				
Input	1 IEC C14 (10 A) socket			
Outputs	4 IEC C13 (10 A)	4 IEC C13 (10 A)	4 IEC C13 (10 A)	4 IEC C13 (10 A)
Remotely controlled sockets	2 groups of 1 x IEC C13 (10 A)	2 groups of 1 x IEC C13 (10 A)	2 groups of 1 x IEC C13 (10 A)	2 groups of 1 x IEC C13 (10 A)
Additional outputs with HS MBP	4 FR/Schuko sockets or 3 BS sockets or 6 IEC 10 A sockets or terminal blocks (HW version)			
Additional outputs with FlexPDU	8 FR/Schuko sockets or 6 BS sockets or 12 IEC 10 A sockets			
Batteries				
Typical backup times for 50 and 70% load	9/6 mn	16/7 mn	14/7 mn	14/7 mn
Battery management	Automatic weekly test (period adjustable), automatic recognition of external battery units => continuous maximisation of backup time + deep discharge protection			
Interfaces				
Communication ports	1 USB port + 1 RS232 serial port and relay contacts (USB and RS232 ports cannot be used simultaneously) + 1 mini terminal block for remote ON/OFF and Remote Power Off			
Communications card slots	1 slot for NMC Minislot card or NMC ModBus/JBus or MC Contacts/Serial			
Operating conditions, standards and approvals				
Operating temperature	0 to 35°C	0 to 35°C	0 to 35°C	0 to 40°C
Noise level	< 40dba	< 40dba	< 40dba	< 40dba
Performance - Safety - EMC	IEC/EN 62040-1-1 (Safety), IEC/EN 62040-2 EN 50091-2 class B (EMC), IEC/EN 62040-3 (Performance), IEC/EN 61000-4-2, 61000-4-3, 61000-4-4, 61000-4-5, 61000-4-6, 61000-4-8 (EMI)			
Approvals	CE, CB report, TÜV			
Dimensions W x D x H / Weight				
Dimensions of the Tower	147 x 418 x 234 mm	147 x 418 x 234 mm	147 x 418 x 234 mm	147 x 492 x 234 mm
Dimensions of the Rack	438 x 366 x 43.2 (1U)	438 x 512 x 43.2 (1U)	438 x 512 x 43.2 (1U)	438 x 556 x 43.2 (1U)
Weight of the Tower/Rack	8.4/10.1 kg	10.85/16.1 kg	12.5/16.6 kg	16.53/20 kg
Customer Service & Support				
2 years warranty	Standard product exchange, including the battery			
Warranty+	Optional 3-years warranty (depending on the country please visit www.eaton.com/powerquality)			
Part Numbers				
Tower	68 450	68 452	68 454	68 457
Rack1U	68 451	68 453	68 455	68 458



Eaton 5PX UPS 1500 - 3000 VA



Rack/Tower versatile



Intuitive LCD display for ease of configuration and management

Advanced protection for:

- Servers
- Switches
- Routers
- Storage devices



Exceptional efficiency, manageability and energy metering capabilities for IT managers

Manageability

- The new graphical LCD display provides clear information on the UPS's status and measurements on a single screen (in seven languages). Enhanced configuration capabilities are also available with easy-to-use navigation keys.
- For the first time in the industry the 5PX can meter energy consumption right down to the managed outlet groups. kWh values can be monitored using the LCD or Eaton's Intelligent Power® Software Suite.
- Load segment control enables prioritised shutdowns of non-essential equipment to maximise battery runtime for critical devices. Load segment control can also be used to remotely reboot locked-up network equipment or to manage scheduled shutdowns and sequential start-ups.
- The 5PX offers Serial and USB connectivity, plus an extra slot for an optional communication card (including SNMP/ Web card or relay contact card). Eaton's Intelligent Power® Software Suite compatible with all major OS including virtualization software such as VMware and Hyper-V is included with each UPS.

Performance and Efficiency

- With an optimised electrical design, the 5PX can provide up to 99% efficiency, reducing cooling and utility costs.
- With a power factor of 0.9, the 5PX delivers more real output power. It powers more servers than other UPSs with equivalent VA ratings and lower power factors. The 5PX is compatible with all modern IT equipment.
- When operating in battery mode the 5PX provides a high quality output signal for any sensitive equipment connected, such as active PFC (power factor corrected) servers.

Availability and Flexibility

- The 5PX is available in a rack/tower convertible version - pedestal and rail kits are included with all models at no extra charge.
- Stronger, longer battery life: Eaton ABM® battery management technology uses an innovative three-stage charging technique that only recharges the battery when necessary, so the battery experiences less corrosion and service life is prolonged by up to 50%.
- Batteries can be hot-swapped without ever having to shut down connected equipment. With an optional, hot-swap maintenance bypass module, you can even replace the entire UPS.
- There is also the possibility to add more runtime with up to four external hot-swappable battery modules, able to run systems for hours if necessary. The additional battery modules are automatically recognised by the UPS.

Eaton 5PX UPS

- 1 Graphical LCD display :
 - Clear information on UPS status and measurements
 - Enhanced configuration capabilities
 - Available in 7 languages
- 2 Panel for batteries replacement (Hot swappable)



Eaton 5PX 3000i RT2U

- 3 1 USB port + 1 serial port + remote ON/OFF and remote power OFF inputs
- 4 External battery (EBM) connector
- 5 8 IEC 10A + 1IEC 16A sockets with energy metering (including 4 programmable sockets)
- 6 Communication card slot

TECHNICAL SPECIFICATIONS	1500	2200	3000
Rating (VA/W)	1500 VA / 1350 W	2200 VA / 1980 W	3000 VA / 2700 W
Format	RT2U (tower / rack 2U)	RT2U (tower / rack 2U)	RT2U & RT3U
Electrical characteristics			
Technology	Line-Interactive High Frequency (Pure Sinewave, Booster + Fader)		
Input voltage and frequency ranges without using batteries	160V-294V (adjustable to 150V-294V) 47 to 70 Hz (50 Hz system), 56.5 to 70 Hz (60 Hz system), 40 Hz in low-sensitivity mode		
Output voltage and frequency	230 V (+6/-10 %) (Adjustable to 200V / 208V / 220V / 230V / 240V), 50/60 Hz +/- 0.1 % (autosensing)		
Connections			
Input	1 IEC C14 (10 A) socket	1 IEC C20 (16 A) socket	1 IEC C20 (16 A) socket
Outputs	8 IEC C13 (10 A)	8 IEC C13 (10 A) sockets 1 IEC C19 (16 A) socket	8 IEC C13 (10 A) sockets 1 IEC C19 (16 A) socket
Remotely controlled sockets	2 groups of 2 x IEC C13 (10 A)		
Additional outputs with HS MBP	4 FR/Schuko sockets or 3 BS sockets or 6 IEC 10 A sockets or terminal blocks (HW version)		
Additional outputs with FlexPDU	8 FR/Schuko sockets or 6 BS sockets or 12 IEC 10 A sockets		
Batteries			
Typical backup times for 50 and 70% load*			
5PX	19/11 mn	15/8 mn	14/9 mn
5PX + 1 EBM	90/54 mn	60/35 mn	66/38 mn
5PX + 4 EBM	285/180 mn	210/125 mn	213/121 mn
Battery management	ABM® & Temperature compensated charging method (user selectable), Automatic battery test, deep discharge protection, automatic recognition of external battery units		
Interfaces			
Communication ports	1 USB port + 1 RS232 serial port and relay contacts (USB and RS232 ports cannot be used simultaneously) + 1 mini terminal block for remote ON/OFF and Remote Power Off		
Communications card slots	1 slot for NMC Minislot card (included in Netpack versions) or NMC ModBus/JBus or MC Contacts/Serial		
Operating conditions, standards and approvals			
Operating temperature	0 to 40°C		
Noise Level	< 45 dBA	< 45 dBA	< 50 dBA
Performance - Safety - EMC	IEC/EN 62040-1-1 (Safety), IEC/EN 62040-2 (EMC), IEC/EN 62040-3 (Performance),		
Approvals	CE, CB report, TÜV		
Dimensions W x D x H / Weight			
UPS Dimensions	441 x 522 x 86,2 (2U) mm	441 x 522 x 86,2 (2U) mm	441 x 647 x 86,2 (RT2U) mm 441 x 497 x 130,7 (RT3U) mm
UPS Weight	27.6 kg	28.5 kg	38.08 (RT2U) - 37.33 (RT3U)
Dimensions of EBM	same as UPS		
Weight of the EBM	32.8 kg	32.8 kg	46.39 (RT2U) - 44.26 (RT3U)
Customer Service & Support			
Warranty	3 years on electronics, 2 years on batteries		

* Runtimes are shown at 0.7 power factor. Backup times are approximate and may vary with equipment, configuration, battery age, temperature, etc.

Part Numbers	1500	1500 Netpack*	2200	2200 Netpack*	3000 (RT3U)	3000 Netpack* (RT2U)
UPS	5PX1500iRT	5PX1500iRTN	5PX2200iRT	5PX2200iRTN	5PX3000iRT3U	5PX3000iRTN
EBM	5PXEBM48RT	5PXEBM48RT	5PXEBM48RT	5PXEBM48RT	5PXEBM72RT3U	5PXEBM72RT2U

* Network Management Card included as standard in Netpack versions



Eaton EX UPS

700/1000/1500/2200/3000 VA



Eaton EX 1500



Eaton EX Rack/Tower versatility

Ideal protection for:

- Servers, data storage and network equipment
- Telephony - VoIP
- Medical equipment - Industrial processes



Double conversion (on-line)

Maximum availability

- **Topology:** double conversion on-line UPS with automatic by-pass and power factor correction
- **Powershare:** the Eaton EX output sockets are individually controlled to provide load-shedding to maximise the backup time and provide remote reboot and sequential start-up as standard
- **Continuous power supply:** Hot swappable batteries. The HotSwap MBP (Maintenance By-Pass) module allows the UPS to be replaced without interrupting the power supply
- **Long backup times:** 1 to 4 EXB battery units can be added to the Eaton EX. The Eaton EX 3000XL has a built-in super charger for extra long backup times

Minimum total cost of ownership

- **Easy operation:** the LCD gives you access to a wide range of measurements and set-up menus
- **Remote supervision:** the Eaton software suite offers a wide range of communication option including: SNMP and HTML, ModBus/JBus and relay outputs

Total flexibility

Eaton EX has unmatched Flexibility.

- **Format:** EX 700 to 1500 are available in tower format or RT2U convertible rack/tower format (compatible with short-depth rack). EX 2200 & 3000 are available in RT2U format (optimised for rack mounting) or RT3U (for tower or short-depth racks)
- **Connections:** with FlexPDU and HotSwap MBP, the RT2U and RT3U models can be connected by sockets or terminal blocks. They can be installed as required, on the side or on top of the unit
- **Compatible with high power factor loads:** Eaton EX is rated for 0.9 power factor (700 VA/630 W, 1000 VA/900 W, 1500 VA/1350 W, 2200 VA/1980 W and 3000 VA/2700 W)
- **Communication:** the EX includes both serial and USB ports, plus remote On/Off connector and an extra slot for optional communication cards. The UPS comes with a complete Eaton software suite.

Eaton EX UPS

- 1 LCD Multilingual display
 - 6 languages,
 - displays measurements,
 - displays alarms,
 - access to control and set-up menus.
- 2 Panel for batteries replacement (Hot swappable)



Eaton EX 3000

- 3 1 USB port + 1 serial port + remote ON/OFF and emergency stop inputs.
- 4 EXB battery unit connector.
- 5 EXB units recognised automatically.
- 6 8 IEC 10A sockets, including 4 Powershare programmable sockets and 1 IEC 16A socket.
- 7 Communication card slot.
- 8 Mountings for HotSwap MBP and FlexPDU.

TECHNICAL SPECIFICATIONS	700	1000 - 1000 RT2U	1500 - 1500 RT2U	2200	3000 - 3000 XL
Rating (VA/W)	700 VA / 630 W	1000 VA / 900 W(1)	1500 VA / 1350 W(1)	2200 VA / 1980 W	3000 VA / 2700 W(1)
Format	Mini tower	Mini tower or RT2U (tower/rack 2U)		RT2U (tower/rack 2U) and RT3U (tower/rack 3U)	
Electrical characteristics					
Architecture	On-line double conversion with automatic by-pass and power factor correction				
Input voltage and frequency ranges without using batteries	100/120/140/160 V to 284V - 40 to 70 Hz for load level <20% / <33% / <66% / >=66% of rated output			100/120/160/184 V to 284V - 40 to 70 Hz for load level <20% / <33% / <66% / >=66% of rated output	
Output voltage and frequency	230 V (adjustable to 200/208/220/240/250 V), 50/60 Hz auto-select or frequency converter mode (2)			230 V (adjustable to 200/208/220/240 V), 50/60 Hz auto-select or frequency converter mode	
Connections					
Input	1 IEC C14 (10A) socket			1 IEC C20 (16A) or terminal block on HotSwap MBP HW (Hard-Wired)	
Outputs	6 IEC C13 (10A) sockets			8 IEC C13 (10A) sockets + 1 IEC C19 (16A) socket	
Remotely controlled Powershare sockets	2 independent groups: 2 + 1 IEC C13 (10A) sockets			2 groups of 2 x IEC C13 (10A) on Eaton EX	
Additional outputs with HotSwap MBP FR/DIN/BS/IEC/HW	4 FR/Schuko sockets or 3 BS sockets or 6 IEC 10A sockets or terminal blocks (HW version)				
Additional outputs with FlexPDU FR/DIN/BS/IEC	8 FR/Schuko sockets or 6 BS sockets or 12 IEC 10A sockets				
Battery					
Typical backup times for 50 and 70% load (5) except for Eaton EX 3000 XL (4)					
EX	16 min / 10 min	18 min / 12 min	13 min / 9 min	17 min / 12 min	15 min / 10 min
EX + 1 EXB	/	75 min / 50 min	50 min / 35 min	85 min / 60 min	60 min / 40 min
EX + 4 EXB	/	250 min / 200 min	180 min / 120 min	285 min / 200 min	190 min / 150 min
Battery management	Automatic weekly test (period adjustable using LCD display or in software supplied), automatic recognition of external battery units => continuous maximisation of backup time + deep discharge protection				
Interfaces					
Indicators and display	3 LEDs + adjustable multilingual display: display of measurements, access to control and set-up menus				
Communication ports	1 USB port + 1 RS232 serial port and relay contacts(3) + 1 mini terminal block for remote ON/OFF and emergency stop				
Communications card slots	1 slot for NMC Minislot card (included in Netpack version) or NMC ModBus/JBus or MC Contacts/Serial				
Operating conditions, standards and approvals					
Operating temperature noise level	0°C to 40°C continuous, 45 dBA				
Performance - Safety - EMC	IEC/EN 62 040-1, IEC/EN 62 040-2, IEC/EN 62 040-3 (VFI-SS-113), IEC/EN 60 950-1 (RD)				
Approvals	CE, TÜV GS, CB report, cTÜV-US			CE, TÜV, CB Report, UL CE, TÜV, CB Report, UL	
Dimensions (H x W x D) / Weight					
EX	242 x 153 x 440 mm / 12.5 kg	242 x 153 x 440 mm / 15 kg	242 x 153 x 490 mm / 18 kg	440 x 131 x 490 mm (6) / 30 kg (3000 XL = 18 kg)	
EX (RT2U format)	/	86.5 x 438 x 483 mm / 18 kg	86.5 x 438 x 483 mm / 20.5 kg	86 x 440 x 640 mm / 31 kg	
EX EXB	/	242 x 153 x 440 mm / 21 kg		440 x 131 x 490 mm (6)	
EX EXB (RT2U format)	/	86.5 x 438 x 483 mm / 24.5 kg		/	
Customer Service & Support					
2 years warranty	Standard product exchange, including the battery				
Warranty+	Optional 3-years warranty (depending on the country please visit www.eaton.com/powerquality)				
1: Maximum rating with EXB battery units: Eaton EX 1000 = 800 W, Eaton EX 1500 =1200 W and Eaton EX 3000=2400W. 2: Derated by 15% when used as a frequency converter. 3: USB and RS232 serial ports cannot be used simultaneously. 4: Except Eaton EX 3000 XL: UPS with high speed charger, without built-in batteries, for custom configurations: ask us for details. 5: Runtimes are shown at 0.7 power factor. Backup times are approximate and may vary with equipment, configuration, battery age, temperature, etc. 6: compatible with 600 mm deep rack					
Part Numbers					
EX	68 180	68 181	68 183	68 400	68 402 - XL: 68 404
EX (RT2U format, includes rack kit)	/	68 182	68 184	68 401	68 403
EX HotSwap (RT3U format, includes rack kit + HotSwap MBP)	/	/	/	FR: 68406 DIN: 68407 BS: 68408 IEC: 68409 HW: 68410	FR: 68412 DIN: 68413 BS: 68414 IEC: 68415 HW: 68416
EX Netpack (RT2U format, includes rack kit and NMC card)	/	/	/	68 411	68 417
EX EXB	/	68 185	68 185	/	/
EX EXB (RT2U format, includes rack kit)	/	68 186	68 186	/	/
EX EXB (RT3U format, includes rack kit)	/	/	/	68 405	68 405
EX Rack Kit 2U/3U	/	/	/	68 441	68 441



Eaton MX UPS

4/5/8/10/15/20 kVA



Eaton MX versatility



Eaton MX Frame

Advanced protection for:

- Departmental networks, servers and workstations



Double conversion (on-line)

High performance UPS upgradeable from 4 kVA to 20 kVA

Continuous power supply

- Two front access hot-swappable sub-modules (power and battery) for maintenance without load interruption
- Automatic battery test (test period can be set)
- Internal bypass built-in to supply the load even if the UPS fails
- Large input voltage and frequency ranges to avoid using the batteries unnecessarily

Total flexibility

- Can be used as a free-standing tower unit or 19" rack-mounted: only 3U for Eaton MX 4000 and 5000, 16U for Eaton MX Frame
- LCD multilingual display with mimic and LEDs for rapid view of the UPS status, diagnostics and event log
- **Outputs:** IEC 10A and 16A outlet sockets and hardwired outputs.
- Built-in Powershare system for remote reboot of the equipment connected, sequential start-up or load shedding while operating from battery to maintain the power to critical loads
- Eaton MX Frame is compatible with three phase or single phase supplies
- **Backup time:** 10 mins up to 2 hours by adding 3U battery extension modules

Minimum total cost of ownership (TCO)

- More power with an output power factor of 0.9
- When the power supply needs to be upgraded, the Eaton MX 4000 and 5000 can be paralleled to provide 8 kVA or 10 kVA using the ModularEasy kit: without extra cost on the initial purchase
- Eaton MX Frame is a modular system with 5 kVA sub-modules paralleled to provide up to 20 kVA or 15 kVA with redundancy

Eaton MX UPS

- 1 8 IEC 10A sockets
- 2 Retention clips
- 3 2 IEC 16A sockets
- 4 Output circuit protection
- 5 1 minislot for NMC, Modbus/JBus or MC Contacts/Serial card
- 6 RJ11 remote power off

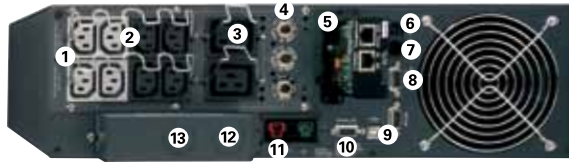

Eaton MX 4000/5000

- 7 RJ45 EXB battery module detection
- 8 DB 9 with 5 output contacts
- 9 DB 9 serial and USB ports
- 10 DB 15 for paralleling
- 11 EXB battery extension module power connector
- 12 Input
- 13 Output

TECHNICAL SPECIFICATIONS	4000	5000	MX Frame 15000	MX Frame 20000
Rating (kVA/kW)	4 kVA / 3.6 kW	5 kVA / 4.5 kW	15 kVA / 13.5 kW	20 kVA / 18 kW
Paralleling				
Maximum rating / redundancy ⁽¹⁾	8 kVA / 4 kVA + 4 kVA redundancy	10 kVA / 5 kVA + 5 kVA redundancy	15 kVA / 10 kVA + 5 kVA redundancy 5 kVA + 2 x 5 kVA redundancy	20 kVA / 15 kVA + 5 kVA redundancy 10 kVA + 2 x 5 kVA redundancy
Inputs				
Technology	VFI-SS-113, on-line double conversion with power factor correction, convection cooled static bypass switch			
Number of phases, input connections	L + N, terminals up to 6 mm ² L + N, terminals up to 6 mm ² L + N or 3P + N, terminals up to 35 mm ² , separate or common AC normal and AC bypass			
Nominal voltage	200/208/220/230/240/250 V	200/208/220/230/240/250 V	200/208/220/230/240/250 V (L + N) or 380/400/415 V (3P + N)	
Voltage range without using battery ⁽²⁾	120 - 280 V	120 - 280 V	120 - 280 V (L + N), 250 - 465 V (3P + N)	
Input frequency range, THDI	40-70 Hz, < 7%			
Outputs				
Output connections ⁽³⁾	Terminals + 8 IEC C13 (10A) + 2 IEC C19 (16A)		Terminals + 8 IEC C13 (10A) + 4 IEC C19 (16A)	
Remotely controlled Powershare sockets	2 groups (2 IEC C13 10A per group)			
Output voltage and frequency ⁽⁴⁾ , THDU, efficiency ⁽⁵⁾	200/208/230/240 /250 V, 50 / 60 Hz autoselect, frequency converter as standard, <2%, 97%			
Backup time⁽⁶⁾				
Eaton MX standard backup time	10 minutes	8 minutes	8 minutes	8 minutes
Eaton MX + EXB / MX + 2 EXB / MX + 3 EXB	45 / 80 / 120 minutes	35 / 60 / 95 minutes	35 min (3 EXB)/60 min (6 EXB) /90 min (9 EXB) (7)	35 min (4 EXB)/60 min (8 EXB) /90 min (12 EXB)
Communications				
Slots	1 slot (MX) or 2 slots (MX Frame) for Network Management Card, NMC ModBus/JBus card or MC Contacts/Serial card			
Ports	Remote Power off (RJ11), 5 output contacts (DB9), setup using Solution-Pac (8) , (USB and DB9-serial ports), EXB module detection (RJ45), paralleling (DB 15)			
Operating conditions, standards and approvals				
Performance, safety, EMC, surge protection	IEC/EN 62 040-3, IEC/EN 62 040-1-1, IEC/EN 62 040-2 class A (class B as option), 4 kV IEC 61 643, UL 1778 and CSA 22.2 (9)			
Operating temperature, noise, approvals, guarantee	0°C to 40°C continuous, 45 dbA (10), UL, TÜV, GS mark, CB, C-Tick, CE, IEC 61 931, one year (11)			
Dimensions H x W x D / Weight				
Eaton MX standard backup tower	444.5 mm x 130.6 mm x 735 mm / 57 kg		Tower 690mm high (795mm casters) x444.5mm wide x735mm deep / 250 kg	
Eaton MX standard backup rack	3U x 444.5 mm wide compatible with 800-1000 mm deep rack		Rack 16U x 444.5 mm wide, compatible with 800-1000 mm deep rack	
Eaton MX EXB battery unit tower / rack	444.5 mm x 130.6 mm x 650 mm / 3U x 444.5 mm wide / 70 kg		Dimensions same as MX Frame / 194 kg for 15 kVA, 239 kg for 20 kVA	
Eaton MX ModularEasy, paralleling kit	Dimensions same as EXB battery unit / 10 kg		/	

Customer Service & Support

1 year guarantee, including batteries.

Warranty+

Optional 3-years warranty (depending on the country please visit www.eaton.com/powerquality)

1: Eaton MXs can be paralleled using ModularEasy. 2: At 70% load. 3: 4 IEC C13 (10A) 2 m long cables for use with retention clips (8 cables for use with Eaton MX Frame). 4: Frequency conversion for non-paralleled units only. 5: Economy mode, 91% in normal mode. 6: At 70% nominal rating with power factor 0.7 typical values after 3 charge/discharge cycles, with 3-5 years old batteries. Weekly battery test without interrupting the load (daily or monthly if required). EXB compatible with 0.8 power factor loads. 7: With Eaton MX Frame EXB (4 battery units). 8: Solution-Pac CD-ROM supplied as standard. 9: Applicable to US models. 10: 50 dbA above 5 kVA. 11: Depending on the country, see www.eaton.com/powerquality.

Part Numbers	MX 4000	MX 5000	MX Frame 15000	MX Frame 20000
Eaton MX Tower or rack-mounting: standard backup time	68 501	68 504	68 513 ⁽¹⁾	68 514 ⁽²⁾
Eaton MX Netpack: standard backup time + NMC + rack kit	68 502	68 505	68 513 ⁽¹⁾	68 514 ⁽²⁾
Eaton MX EXB: battery extension module	68 515	68 515	add multiple MX EXB : 68 515	
Eaton MX ModularEasy: paralleling kit (2 Eaton MX)	68 520	68 520	/	/
Eaton MX / EXB Rack Kit: rail kit for 19" rack mounting	68 002	68 002	/	/
IEC 32 A kit , 2 X 2 m long cables: male to hardwired and female to hardwired	68 525	68 525	/	/
MX 1,8 m Battery extension cable	68 528	68 528	68 528	68 528
MX Battery / Power electronics sub-module	68 524 / 68 522	68 524 / 68 523	68 524 / 68 523	68 524 / 68 523
Eaton MX Frame empty chassis	/	/	68 526	68 526
Battery Integration System (up to 9 EXB)	/	/	68 527	68 527

1: (with rack kit, casters, NMC card) 68 513 = 68 526 (empty Eaton MX Frame) + 3 x 68 524 + 3 x 68 523.

2: (with rack kit, casters, NMC card) 68 514 = 68 526 (empty Eaton MX Frame) + 4 x 68 524 + 4 x 68 523.



Eaton EX RT UPS

7/11 kVA single phase input / single phase output
5/7/11 kVA three phase input / single phase output



Eaton EX RT



Battery Integration system

Advanced protection for:

- Rack servers enclosures and industrial environment



Double conversion (on-line)

High performance UPS for single phase applications.

Maximum availability

- Hot swappable UPS and battery modules
- Internal bypass and maintenance bypass included as standard
- The UPS can be connected to two independent electrical sources (sources 1 and 2 can be common or separate)
- Large input voltage range without draining the battery: 230V + 20% to - 30% single phase and 400V + 15% to - 20% three phase
- Batteries tested automatically at regular intervals and protected against deep discharge
- N+1 redundancy supported by two single units

Wide choice of backup times

- From 10 minutes to 2 hours with battery modules or up to 8 hours using the CLA charger module
- Automatic recognition of battery modules and easy battery installation with battery integration system

Ergonomy

- Multilingual LCD display and LEDs for rapid view of the UPS status and the operating log
- Self diagnosis and fault messages

Can be integrated into even the most demanding environments:

Computer

- Tower / 6U Rack convertible
- Comprehensive range of Power Distribution Units for convenient power distribution within the rack

Industrial

- Compatible with all types of generator set
- Can be integrated into building management systems
- Steel casing
- Operating temperature up to 45°C
- Meets Marine vibration test requirements

Eaton EX RT UPS

- 1 Slot for Eaton minislot communication card
- 2 9-pin D output connector
- 3 RJ11 port for remote emergency power off
- 4 Connectors for automatic detection of battery module(s)
- 5 RS 232 communication port
- 6 Connector for EXB modules



- 7 Manual bypass for hot maintenance
- 8 Output connectors
- 9 Source switch 1
- 10 Source 1 connector
- 11 Source 2 connector
- 12 Battery circuit breaker

TECHNICAL SPECIFICATIONS	5 kVA	7 kVA	11 kVA
Active power kVA / kW	5 kVA / 4 kW (single phase input not available for 5 kVA)	7 kVA / 4.9 kW	11 kVA / 8 kW
Technology	On-line double conversion with PFC (Power Factor Correction) system (applicable to single phase models)		
Rated input voltage	200/208/220/230/240/250 V single phase 380/400/415V three phase		
Input voltage range	(- 30%; + 20%) 230 V; (- 20%, + 15%) 400 V		
Input, output frequency range	40-70 Hz, 50 / 60 HZ autoselection, frequency converter as a standard		
Output voltage / THDU	200/208/230/240 /250 V +/- 2%; THDU < 2%		
Overall efficiency	Normal mode 91%, eco mode 97%		
THDI	THDI < 5% (single phase input value)		
Crest factor / short circuit current	3:1 / 100 A	3:1 / 100 A	3:1 / 150 A
Overload capacity	>150% 500 ms; 150% 30 s; 125% 60 s; 110% 120 s		
Temperature operating	45°C for 8 Hrs (at nominal output power for 230 V or 400V input and 230V output), 40°C continuous		
Back-up times* at 70% load			
From 10 up to 15 minutes	Standard: 1 power mod. 3U + 1 battery mod. EXB 3U = 6U		
From 15 up to 20 minutes	Standard + 1 battery mod. EXB 3U = 9U		
From 40 up to 65 minutes	Standard + 2 battery mod. EXB 3U = 12U		
Connection			
Input/output	Terminal block for 13 mm ² (stranded cable) or 10 mm ² (solid cable)		
Communication			
Port type	6 voltage free contacts DB9 2 A 48 V DC, 1 RS 232, RJ11 for remote emergency power off		
Slot	1 slot for communication card		
Standards and certification			
Performance and safety	IEC 62040-1/IEC 60950/UL 1778 and CSA 22.2 (applicable to single phase models)		
EMC	IEC 62040-2; EN 50091-2; FCC class A (applicable to single phase models), EMC B level (option for single phase model)		
Certification	UL (applicable to single phase models)/TUV, GS mark,CB, C-Tick,CE, IEC 68-2-6 (vibration tests Marine approval)		
Dimensions H x W x D / Weight (single phase input / three phase input)			
Eaton EX RT standard backup tower	444.5 x 261.2 x 700 mm 89.5 kg	444.5 x 261.2 x 700 mm 88.3 kg / 89.5 kg	444.5 x 261.2 x 700 mm 94.2 kg / 95.3 kg
Eaton EX RT standard backup Network Pack rack mounting	261.2 (6U) x 444.5 x 700 mm 97.3 kg	261.2 (6U) x 444.5 x 700 mm 96.1 kg / 97.3 kg	261.2 (6U) x 444.5 x 700 mm 102 kg / 103.1 kg
Eaton EX RT Power module	444.5x130.6x700/130.6 (3U)x444.5x700 mm 24.2 kg	444.5x130.6x700/130.6 (3U)x444.5x700 mm 23 kg / 24.2 kg	444.5x130.6x700/130.6 (3U)x444.5x700 mm 24.9 kg / 26 kg
Battery module Eaton EXB RT	444.5x130.6x650/130.6 (3U)x444.5x650 mm 64.5 kg	444.5x130.6x650/130.6 (3U)x444.5x650 mm 64.5 kg	444.5x130.6x650/130.6 (3U)x444.5x650 mm 68.5 kg
EX RT CLA module / EX RT Transformer	130.6 (3U) x 444.5 x 650 mm / 12 kg / 87 kg	130.6 (3U) x 444.5 x 650 mm / 12 kg / 87 kg	130.6 (3U) x 444.5 x 650 mm / 12 kg / 87 kg
Customer Service & Support			
1 year warranty, including battery	Free standard replacement for faulty units, including the batteries		
Warranty+	Optional 3-years warranty (depending on the country please visit www.eaton.com/powerquality)		

* (typical values after 3 discharge cycles, batteries 3-5 years, longer backup times available using the CLA or EXB module, ask for details)

Part Numbers	EX RT 5		EX RT 7		EX RT 11	
	Single-phase	Three-phase	Single-phase	Three-phase	Single-phase	Three-phase
Eaton EX RT standard back-up time Tower	/	68 054	68 070	68 074	68 110	68 114
Network Pack Rack Format(1)	/	68 056	68 072	68 076	68 112	68 116
EXB RT battery module / EXB RT battery module with EPO built-in	/	68 078 / 68 079	68 078 / 68 079	68 078 / 68 079	68 118 / 68 119	68 118 / 68 119
Eaton EX RT Power module (for use with EXB or CLA module)	/	68 057	68 075	68 077	68 115	68 117
Rack kit for Eaton EX RT Power module / Eaton EXB RT and CLA	/	68 001 / 68 002	68 001 / 68 002	68 001 / 68 002	68 001 / 68 002	68 001 / 68 002
Eaton EX RT Transformer module	/	68 003	68 003	68 003	68 003	68 003
Eaton EX RT CLA module (2 to 8 hours)	/	68 004	68 004	68 004	68 004	68 004
EX RT Battery Integration System (2)	/	68 005	68 005	68 005	68 005	68 005
EMC B level filter module	/	/	68 008	/	68 008	/
EX RT PDU 19" rack format(3)	/	66 857	66 857	66 857	66 857	66 857
1.8 m battery connection cable(4)	/	68 006	68 006	68 006	68 006	68 006
UPS Control, remote UPS monitor display	/	66 080	66 080	66 080	66 080	66 080

1: the Network Pack version includes standard back-up time unit + Network Management Card + rack mounting kit. 2: trolley capacity 8 modules max, casters, adjustable feet. 3: 12 sockets 4 X IEC 16 A + 8 X IEC 10 A. 4: for non standard inter-module spacing.



Eaton 9155 and 9355 UPS

8 - 15 kVA



Advanced power protection for:

- Banking
- Small server and computer rooms
- Healthcare
- Network communications
- Security systems
- Automation systems



Double conversion UPS

Premium power performance

- Double conversion topology provides the highest level of protection available by isolating the output power from all input anomalies.
- With a transformer-free design and sophisticated sensing and control circuitry the 9155/9355 delivers an efficiency of up to 92%.
- Active power factor correction (PFC) provides unbeatable 0,99 input power factor and less than 4,5% ITHD, thus eliminating interference with other critical equipment in the same electrical network and enhancing compatibility with generators.
- With 0.9 output power factor, UPS is optimized to protect modern IT equipment without need to oversize.

True reliability

- Hot Sync technology enables paralleling of two or more UPS modules to increase availability or add capacity. The technology enables load sharing without any communication line, thus eliminating single point of failure.
- ABM technology charges batteries only when necessary, reducing batteries corrosion and prolonging batteries service life by up to 50%.
- Internal batteries in all standard configurations provide an extended runtime with the smallest footprint.

Extensive configurability

- Further runtime extension is possible with external battery cabinets.
- A multilingual graphical LCD display makes possible to monitor the UPS status easily.
- The 9155/9355 can also be integrated into network management, industrial automation and building management systems.
- Bundled Eaton Software Suite provides an orderly network shutdown in an event of extended power outage.

Cost savings and sustainability

- The 9155/9355 features high up to 92% efficiency, thus reducing utility costs, extending battery runtimes and producing cooler operating conditions.
- Compact space efficient tower design offers smaller footprint enabling easy data centre space-planning and preserving valuable raised-floor real estate.
- Included internal batteries eliminate the need for costly and space-consuming external battery cabinets.
- A single technical platform used in Eaton's three-phase UPS products guarantee easy upgrades and similarity in service, thus lowering total cost of ownership.
- A range of service agreement options can be easily customized for customers' needs and budget.
- Eaton uses sustainable materials and highly efficient manufacturing technology, thus generating dramatic savings in carbon footprint as compared to competitive UPS systems.

Eaton 9155/9355 UPS 8-15 kVA

TECHNICAL SPECIFICATIONS

UPS output power rating (0,9 p.f.)

kVA	8	10	12	15
kW	7,2	9	10,8	13,5

General

Efficiency in double conversion mode (full load)	92%
Efficiency in double conversion mode (half load)	90%
Efficiency in high efficiency mode	up to 98%
Distributed parallelling with Hot Sync technology	4
Field upgradeable	yes
Inverter/rectifier topology	transformer-free IGBT with PWM
Audible noise	<50 dB
Altitude (max)	1000 m without derating (max 2000 m)

Input

Input wiring	1 ph or 3 ph + N + PE
Nominal voltage rating (configurable)	220/380, 230/400, 240/415 V 50/60 Hz
Input voltage range	Low -20% at 100% load/-50% at 50% load without battery discharge; High +10% /max +20%
Input frequency range	45-65 Hz
Input power factor	0,99
Input ITHD	less than 4,5%
Soft start capability	Yes
Internal backfeed protection	Yes

Output

Output wiring	1 ph or 3 ph + N + PE
Nominal voltage rating (configurable)	220/380, 230/400, 240/415 V 50/60 Hz

Output UTHD	<3% (100% linear load); <5% (reference non linear load)
Output power factor	0,9 (e.g. 9 kW at 10 kVA)
Permitted load power factor	0,7 lagging - 0,8 leading
Overload on inverter	10 min 100-110%; 1 min 110-125%; 5 sec 125-150%; 300 ms >150%
Overload when bypass available	60 min 100-110%, 10 min 110-125%; 1 min >125-150%

Battery

Type	Maintenance free VRLA batteries, NiCd
Charging method	ABM technology or Float
Temperature compensation	Optional
Battery nominal voltage (lead-acid)	384 V (32x12 V, 192 cells)
Charging current / Model	Default 3 A *Max 30 A

*May be limited by maximum UPS input current rating

Accessories

Isolation transformer, long-life batteries, external battery cabinets, UPS Center (input, bypass, distribution), X-Slot connectivity (Web/SNMP, ModBus/Jbus, Relay, Hot Sync, ViewUPS-X remote display), Hot Sync parallel tie cabinet, integrated manual bypass, external maintenance bypass switch

Communications

X-Slot	2 communication bays
Serial ports	1 available
Relay inputs/outputs	2/1 programmable

Compliance with standards

Safety (CB certified)	IEC 62040-1, IEC 60950-1
EMC	IEC 62040-2
Performance	IEC 62040-3

Stand-alone UPS with 1-phase input

Part number	Description	Rating	Back-up (pf. 0.7)	Dimensions (HxWxD)	Weight
1022532	9155-8-S-10-32x7Ah	8 kVA / 7.2 kW	10 min	817x305x702 mm	155 kg
1022533	9155-8-S-15-32x9Ah	8 kVA / 7.2 kW	15 min	817x305x702 mm	160 kg
1022534	9155-8-S-28-64x7Ah	8 kVA / 7.2 kW	28 min	1214x305x702 mm	250 kg
1022535	9155-8-S-33-64x9Ah	8 kVA / 7.2 kW	33 min	1214x305x702 mm	275 kg
1022536	9155-10-S-10-32x9Ah	10 kVA / 9 kW	10 min	817x305x702 mm	160 kg
1022537	9155-10-S-20-64x7Ah	10 kVA / 9 kW	20 min	1214x305x702 mm	250 kg
1022538	9155-10-S-25-64x9Ah	10 kVA / 9 kW	25 min	1214x305x702 mm	275 kg

Stand-alone UPS with 3-phase input

Part number 9155/9355	Description	Rating	Back-up (pf. 0.7)	Dimensions (HxWxD)	Weight
1022480	9155-8-N-10-32x7Ah	8 kVA / 7.2 kW	10 min	817x305x702 mm	155 kg
1022481/1023411	9155/9355-8-N-15-32x9Ah	8 kVA / 7.2 kW	15 min	817x305x702 mm	160 kg
1022482	9155-8-N-28-64x7Ah	8 kVA / 7.2 kW	28 min	1214x305x702 mm	250 kg
1022483/1023412	9155/9355-8-N-33-64x9Ah	8 kVA / 7.2 kW	33 min	1214x305x702 mm	275 kg
1022484/1023413	9155/9355-10-N-10-32x9Ah	10 kVA / 9 kW	10 min	817x305x702 mm	160 kg
1022485	9155-10-N-20-64x7Ah	10 kVA / 9 kW	20 min	1214x305x702 mm	250 kg
1022486/1023414	9155/9355-10-N-25-64x9Ah	10 kVA / 9 kW	25 min	1214x305x702 mm	275 kg
1022487/1023415	9155/9355-12-N-8-32x9Ah	12 kVA / 10.8 kW	8 min	817x305x702 mm	160 kg
1022488	9155-12-N-15-64x7Ah	12 kVA / 10.8 kW	15 min	1214x305x702 mm	250 kg
1022489/1023416	9155/9355-12-N-20-64x9Ah	12 kVA / 10.8 kW	20 min	1214x305x702 mm	275 kg
1022490/1023417	9155/9355-15-N-5-32x9Ah	15 kVA / 13.5 kW	5 min	817x305x702 mm	160 kg
1022491	9155-15-N-10-64x7Ah	15 kVA / 13.5 kW	10 min	1214x305x702 mm	250 kg
1022492/1023418	9155/9355-15-N-15-64x9Ah	15 kVA / 13.5 kW	15 min	1214x305x702 mm	275 kg

External battery cabinets

Part number	Description	Rating	Back-up (pf. 0.7)	Dimensions (HxWxD)	Weight
1022561	9X55-BAT5-64x7Ah	2x32x7 Ah	See page 64	817x305x699 mm	195 kg
1022562	9X55-BAT5-96x7Ah	3x32x7 Ah		1214x305x699 mm	310 kg

Eaton 9355 UPS

20 - 40 kVA



Advanced power protection for:

- Financial services
- Medium size servers and computers
- ICT
- Critical building infrastructure
- Industrial applications



Double conversion UPS

Premium power performance

- Double conversion topology provides the highest level of protection available by isolating the output power from all input anomalies.
- With a transformer-free design and sophisticated sensing and control circuitry the 9355 delivers an efficiency of up to 93%.
- Active power factor correction (PFC) provides unbeatable 0,99 input power factor and less than 4,5% input ITHD, thus enhancing compatibility with generators and eliminating interference with other critical equipment in the same network.
- The UPS enables optimal power protection for modern 0,9 p.f. rated IT equipment without the need to oversize.
- The 9355 design is also available with 1-phase output (9155) at 20-30kVA power ratings.

True reliability

- Hot Sync technology makes possible to parallel two or more UPSs to increase availability or add capacity. The technology enables load sharing without any communication line, thus eliminating single point of failure.
- ABM technology charges batteries only when necessary, preventing batteries corrosion and prolonging batteries service life by up to 50%.
- Internal batteries in all standard configurations support more runtime than comparable UPS.

Extensive configurability

- Configurable and multilingual LCD control panel with back light and graphical mimic screen monitors the UPS status easily.
- Connectivity options guarantee a smooth integration with various application systems requirements.
- Bundled with Eaton Software Suite the 9355 provides an orderly network shutdown in an event of extended power outage. If required, the 9355 can also be integrated to network management, industrial automation and building management systems.

Cost savings and sustainability

- The 9355 features high up to 93% efficiency, thus reducing utility costs, extending battery runtimes and producing cooler operating conditions.
- Compact space efficient tower design offers smaller footprint enabling easy data centre space-planning and preserving valuable raised-floor real estate.
- Internal batteries often eliminate the need for costly and space-consuming external battery cabinets.
- A single technical platform used in Eaton's three-phase products guarantee easy upgrades and similarity in service, thus lowering total cost of ownership.
- A range of service agreement options can be easily customized for customers needs and budget.
- Eaton uses sustainable materials and highly efficient manufacturing technology, thus generating dramatic savings in carbon footprint as compared to competitive UPS systems.

Eaton 9355 UPS 20 - 40 kVA

TECHNICAL SPECIFICATIONS

UPS output power rating (0,9 p.f.)

kVA	20	30	40
kW	18	27	36

General

Efficiency in double conversion mode (full load)	93%
Efficiency in double conversion mode (half load)	91%
Distributed parallelling with Hot Sync technology	4
Field upgradeable	yes
Inverter/rectifier topology	transformer-free IGBT with PWM
Audible noise	<50 dB
Altitude (max)	1000 m without derating (max 2000 m)

Input

Input wiring	3 ph + N + PE
Nominal voltage rating (configurable)	220/380, 230/400, 240/415 V 50/60 Hz
Input voltage range	Low -20% at 100% load/-50% at 50% load without battery discharge; High +10%/max +20%
Input frequency range	45-65 Hz
Input power factor	0,99
Input ITHD	less than 4,5%
Soft start capability	Yes
Internal backfeed protection	Yes

Output

Output wiring	1 ph or 3 ph + N + PE
Nominal voltage rating (configurable)	220/380, 230/400, 240/415 V 50/60 Hz
Output UTHD	<3% (100% linear load); <5% (reference non linear load)

Output power factor	0,9 (e.g. 27 kW at 30 kVA)
Permitted load power factor	0,7 lagging - 0,8 leading
Overload on inverter	10 min 100-110%; 1 min 110-125%; 5 sec 125-150%; 300 ms >150%
Overload when bypass available	60 min 100-110%, 10 min 110-125%; 1 min >125-150%

Battery

Type	Maintenance free VRLA batteries, NiCd
Charging method	ABM technology or Float
Temperature compensation	Optional
Battery nominal voltage (lead-acid)	432 V (36x12 V, 216 cells)
Charging current / Model	Default 3 A *Max 60 A

*May be limited by maximum UPS input current rating

Accessories

Isolation transformer, long-life batteries, external battery cabinets, X-Slot connectivity (Web/SNMP, ModBus/Jbus, Relay, Hot Sync, ViewUPS-X remote display), Hot Sync parallel tie cabinet, integrated manual bypass, external maintenance bypass switch

Communications

X-Slot	2 communication bays
Serial ports	1 available
Relay inputs/outputs	2/1 programmable

Compliance with standards

Safety (CB certified)	IEC 62040-1, IEC 60950-1
EMC	IEC 62040-2
Performance	IEC 62040-3

Standard UPS with 3-phase input

Part number 9355	Description	Rating	Runtime (pf 0.7)	Dimensions (HxWxD)	Weight
1025061/1026598	9355/9155-20-N-5-1x9Ah-MBS	20 kVA / 18 kW	5 min	1684x494x762 mm	300 kg
1025062/1026599	9355/9155-20-N-13-2x9Ah-MBS	20 kVA / 18 kW	13 min	1684x494x762 mm	400 kg
1025063/1026600	9355/9155-20-N-22-3x9Ah-MBS	20 kVA / 18 kW	22 min	1684x494x762 mm	500 kg
1025064/1026601	9355/9155-20-N-31-4x9Ah-MBS	20 kVA / 18 kW	31 min	1684x494x762 mm	600 kg
1025065/1026602	9355/9155-30-N-7-2x9Ah-MBS	30 kVA / 27 kW	7 min	1684x494x762 mm	400 kg
1025066/1026603	9355/9155-30-N-13-3x9Ah-MBS	30 kVA / 27 kW	12 min	1684x494x762 mm	500 kg
1025067/1026604	9355/9155-30-N-20-4x9Ah-MBS	30 kVA / 27 kW	20 min	1684x494x762 mm	600 kg
1025795	9355-40-N-8-3x9Ah-MBS	40 kVA / 36 kW	8 min	1684x494x762 mm	517 kg
1025796	9355-40-N-12-4x9Ah-MBS	40 kVA / 36 kW	12 min	1684x494x762 mm	617 kg

External battery cabinets 9155/9355

Part number	Description	Rating	Runtime	Dimensions (HxWxD)	Weight
1025169	9355-BAT-1x24Ah	1x36x24 Ah	See page 65	1684x494x758 mm	510 kg
1025170	9355-BAT-2x24Ah	2x36x24 Ah	See page 65	1684x494x758 mm	870 kg

9355 20-40 kVA runtimes

Runtimes for UPS with internal batteries ...p.f. 0.7 (typical IT server/computer load)

Battery	Qty	5	10	15	20	25	30	35	40	kVA
7 Ah 12 V	1 x 36	24	8	5	-	-	-	-	-	min
9 Ah 12 V	1 x 36	30	12	7	5	-	-	-	-	min
7 Ah 12 V	2 x 36	60	24	14	10	6	-	-	-	min
9 Ah 12 V	2 x 36	70	28	18	13	10	7	5	-	min
7 Ah 12 V	3 x 36	103	41	26	17	12	10	7	5	min
9 Ah 12 V	3 x 36	115	46	31	22	16	13	10	8	min
7 Ah 12 V	4 x 36	152	55	40	26	18	15	11	9	min
9 Ah 12 V	4 x 36	158	63	42	31	23	20	15	12	min

Eaton BladeUPS

12 – 60 kW



An Eaton Green Solution

Due to outstanding green performance, Eaton BladeUPS has earned the "An Eaton Green Solution"™ label

Advanced power protection for:

- Small, medium and large data centres
- Blade servers
- Network environment
- PBX and VoIP equipment
- Networking applications: IPTV, security
- Storage devices: RAID, SAN



High Efficiency UPS for Data Centres

Premium power performance

- BladeUPS provides scalable, flexible backup power optimized for high-density blade servers and IT equipment.
- A single module of BladeUPS provides 12 kW of power in only 6U of standard rack space, including batteries
- A scalable solution that delivers up to 60 kW of redundant power in a single rack enclosure.
- BladeUPS delivers an industry-leading 98% efficiency, resulting in cooler operating conditions and less heat dissipation.

True reliability

- Hot Sync technology makes it possible to parallel up to six UPS modules for extra capacity or redundancy.
- ABM technology charges batteries only with necessary, preventing battery corrosion and prolonging battery service life by up to 50%.
- Replacing hot-swappable batteries and electronic modules can be done without interrupting the power, which dramatically improves the availability of the protected IT equipment.

Extensive configurability

- BladeUPS is extremely flexible and supports a variety of system architectures to fit to your specific requirements and desired levels of redundancy. BladeUPS also accommodates growth through its scaleable building-block architecture.
- Due to the low heat dissipation, air conditioning requirements reduce by up to a third and BladeUPS can be located close to IT equipment.
- BladeUPS automatically detects parallel modules and self-configures for parallel operation.
- A module working in a parallel configuration can be separated and easily re-deployed as a stand-alone module.
- Each BladeUPS can be configured with its own external battery backup.
- BladeUPS is a scalable UPS with its own power distribution, courtesy of the Rack Power Module. The 3U RPM delivers single-phase power and can be deployed in the same rack as the UPS and IT equipment.
- BladeUPS can be monitored over LAN or the Internet.

Cost savings and sustainability

- A high level of efficiency leads to utility cost saving, with a 60 kW N+1 solution paying for itself over a 5 year period through energy and cooling savings alone.
- The small footprint of BladeUPS allows extra space for IT equipment in the rack and data centre.
- Eaton uses sustainable materials and highly efficient manufacturing technology to dramatically reduce the carbon footprint when compared to other UPS systems on the market.

TECHNICAL SPECIFICATIONS

General

Power Rating	12 kW per UPS module
Efficiency	Up to 98 per cent
Heat Dissipation	371W/1266 BTU/hr at 100% rated load
Cooling	Fan cooled, temperature microprocessor monitored; front air entry, rear exhaust
Audible Noise, Normal Operation	<60 dBA at 1 meter
Altitude Before Derating	1000 meters (3300 ft ASL)

Input

Input Voltage	400 Vac
Voltage Range	400V: 311 to 519 Vac, phase to phase
Frequency Range	50 or 60 Hz, ±5 Hz
Input Current Distortion	<5% with IT loads (PFC power supplies)
Input Power Factor	>0.99 with IT loads (PFC power supplies)
Inrush Current	Load dependent
Input Requirements	Three-phase, four-wire + ground
Bypass Source	Same as input (single feed)
Generator Compatibility	Fast sync slew rate for generator synchronisation

Output

Rated Output Voltage	400V: 180 to 240 Vac, Ph to N
Output Configuration	Three-phase, four-wire + ground
Output Frequency (nominal)	50 or 60 Hz auto-detection on startup
Frequency Regulation	0.1 Hz free running
Load Power Factor Range	Lagging: 0.7 Leading: 0.9
Total Output Voltage Distortion	<3% with IT loads (PFC power supplies) <5% non-linear or non-PFC power supplies

Battery

Battery Type	VRLA - AGM
Battery Runtime (Internal)	13 minutes at 50 per cent load 4.7 minutes at 100 per cent load
Battery String Voltage	240 Vdc
Battery Test	Automatic battery test standard (remote scheduling capable) Manual battery test from front display
Battery Recharge Profile	ABM three-stage charging technology
Battery Cut-off Voltage	Variable from 1.67 VPC at <5 min. runtime
Battery Low Condition	Announced with alarm
Extended Battery Capability	Yes, add up to four additional 3U battery enclosures (~34 min at 100 per cent load, >1 hour at 50 per cent load)

Physical

Dimensions (HxWxD) UPS	261 (6U) x 442 x 660 mm
Note: Total Chassis Weight without batteries or electronics	46 kg
Total Chassis Weight with batteries or electronics	140 kg
Total UPS Weight without Batteries	61 kg
Total UPS Weight with Batteries	140 kg
EBM Weight	77 kg

Communications and User Interface

Software Compatibility	UPS ships with Software Suite CD
X-Slot Bays	Two available for the cards listed below
Control Panel LCD	Two lines by 20 characters Four menu-driven interface buttons Four status at a glance LEDs
Multi-language	English standard; 20 languages available
Configuration Changes	User capable, firmware auto configures
Dry Contact Inputs	Two, user-configurable
Dry Contact Outputs	One, user-configurable

Service

Installation	User capable, located in the IT racks
Preventative Maintenance	User capable, optional factory service available
Corrective Maintenance	User capable, optional factory service available
Serviceability Features	Hot-swappable batteries Hot-swappable electronics module Automated internal maintenance bypass Auto-configure firmware Flash firmware upgradeable

Certifications

EMI	IEC 62040
Surge Protection	ANSI C62.41, Cat B-3
Hazardous Materials (RoHS)	EU Directive 2002/95/EC Category 3 (4 of 5)

Warranty

Standard	12 months
Warranty Repair	Factory depot repair or replace

Options and Accessories

Detachable input cord	
Detachable input/output cord assembly	
Detachable paralleling cord assembly	
Extended Battery Modules (EBMs)	
3U output sub-distribution module	
0U to 3U rack power strips	
60 kW BladeUPS Parallel Bar	
Four-post rail kit	

Optional X-Slot Communication Cards

Application	Card
Web SNMP	ConnectUPS-X Web/SNMP Card
Environment Monitoring	EMP Environmental Monitoring Probe (requires Web/SNMP card)
IBM eServer™ (i5™, iSeries™, or AS/400), industrial Parallel	Relay Interface Card
Remote Monitoring	Hot Sync Card
Remote LCD Display	Modem Card
	ViewUPS-X

Recommended ePDU:

Y032440CD100000	RPM - Rack Power Module (BladeUPS in, 12xC13 + 6xC19 out) 20 ft lead
PW107BA0UC08	ePDU - Basic (0U, Dual 16A C20 in, 24xC13+ 8xC19 out) use in addition to RPM
PW107MI0UC08	ePDU - IP Monitored (0U, Dual 16A C20 in, 24xC13+ 8xC19 out) use in addition to RPM

Eaton 9390 UPS

40 - 160 kVA



Advanced power protection for:

- Data centers
- Financial services
- Building management
- Telecommunications
- Industrial automation equipment
- Healthcare



Double conversion UPS

Premium power performance

- Double conversion provides the highest level of protection available by isolating the output power from all input anomalies.
- With a transformer-free design and sophisticated sensing and control circuitry the 9390 UPS delivers an efficiency of up to 94%.
- Innovative Energy Saver System (ESS) technology enables UPS efficiency to reach 99 percent.
- Active power factor correction (PFC) provides unbeatable 0,99 input power factor and less than 4,5 percent ITHD, thus eliminating interference with other critical equipment in the same network and enhancing compatibility with generators.
- The UPS is optimized for protecting modern 0,9 p.f. rated IT equipment without the need to oversize.

True reliability

- Hot Sync technology makes possible to parallel up to seven UPSs to increase availability or add capacity. The technology enables load sharing without any communication line, thus eliminating single point of failure.
- ABM technology charges batteries only when necessary, preventing batteries corrosion and prolonging batteries service life by up to 50%.
- Increased overall reliability of the UPS due to the high level of efficiency.

Extensive configurability

- The 9390 offers small footprint compared to competitive UPS offerings. Cabling can enter the UPS from either the top or bottom of the cabinet to provide easier and flexible installation.
- A multilingual graphical LCD display makes possible to monitor the UPS status easily.
- Wide software and connectivity options provide monitoring, management and shutdown capabilities over the network.
- Connectivity options are available to suit nearly any communication requirements, from standard serial communications to secure remote monitoring over the Web.

Cost savings and sustainability

- High level of system efficiency leads to utility cost saving, extension of battery run times and cooler operating conditions within the UPS, which extends the life of components.
- As the compact 9390 can be installed against back and side walls, customers have more location options, installation is faster and easier, deployment costs are lower and more valuable data centre space can be saved for future needs.
- A single technical platform used in Eaton's three-phase UPS products guarantee easy upgrades, similarity or service trainings and documentation, thus lowering total cost of ownership.
- A range of service agreement options can be easily customized for customers needs and budget.
- ESS and the use of sustainable materials generate dramatic savings in carbon footprint as compared to competitive UPS systems.

Eaton 9390 UPS 40-160 kVA

TECHNICAL SPECIFICATIONS

UPS output power rating (0,9 p.f.)

kVA	40	60	80	100	120	160
kW	36	54	72	90	108	144

General

Efficiency in double conversion mode (full load)	94%
Efficiency in double conversion mode (half load)	92,5%
Efficiency in Energy Saver System (ESS)	up to 99%
Distributed parallelling with Hot Sync technology	6 + 1
Field upgradeable	yes
Inverter/rectifier topology	transformer-free IGBT with PWM
Audible noise	<65 dB
Altitude (max)	1000 m without derating (max 2000 m)

Input

Input wiring	3 ph + N + PE
Nominal voltage rating (configurable)	220/380, 230/400, 240/415 V 50/60 Hz
Input voltage range	Low -20% at 100% load/-50% at 50% load without battery discharge; High +10%/max +20%
Input frequency range	45-65 Hz
Input power factor	0,99
Input ITHD	less than 4,5%
Soft start capability	Yes
Internal backfeed protection	Yes

Output

Output wiring	3 ph + N + PE
Nominal voltage rating (configurable)	220/380, 230/400, 240/415 V 50/60 Hz

Output UTHD	<3% (100% linear load); <5% (reference non linear load)
Output power factor	0,9 (e.g. 72 kW at 80 kVA)
Permitted load power factor	0,7 lagging - 0,8 leading
Overload on inverter	10 min 100-110%; 30 sec 110-125%; 10 sec 125-150%; 300 ms >150%
Overload when bypass available	Continuous 100-110%, 10 min 110-150%, 5 ms 1000% Note! Bypass fuses may limit the overload capability

Battery

Type	Maintenance free VRLA batteries, NiCd
Charging method	ABM technology or Float
Temperature compensation	Optional
Battery nominal voltage (lead-acid)	480 V (40 x 12 V, 240 cells)
Charging current / Model	40 60 80 100 120 160
Default A	10 20 20 30 30 40
Max* A	20 40 40 60 60 80

*May be limited by maximum UPS input current rating

Accessories

External battery cabinets with long-life batteries, X-Slot connectivity (Web/SNMP, ModBus/Jbus, Relay, Hot Sync, ViewUPS-X remote display), Hot Sync parallel tie cabinet, integrated manual bypass up to 80 kVA, external maintenance bypass switch

Communications

X-Slot	4 communication bays
Serial ports	1 available
Relay inputs/outputs	6/3 programmable

Compliance with standards

Safety (CB certified)	IEC 62040-1, IEC 60950-1
EMC	IEC 62040-2
Performance	IEC 62040-3

Standard UPS

Part number	Description	Rating	Dimensions (HxWxD)	Weight
1028510	9390-40-N-4x0	40 kVA / 36 kW	1879x519x808 mm	257 kg
1028511	9390-60-U-4x0	60 kVA / 54 kW	1879x519x808 mm	313 kg
1028512	9390-80-N-4x0	80 kVA / 72 kW	1879x519x804 mm	313 kg
1028513	9390-100-U-4x0	100 kVA / 90 kW	1879x944x804 mm	430 kg
1028514	9390-120-N-4x0	120 kVA / 108 kW	1879x944x804 mm	430 kg
1028515	9390-120-U-4x0	120 kVA / 108 kW	1879x944x804 mm	530 kg
1028516	9390-160-N-4x0	160 kVA / 144 kW	1879x944x804 mm	530 kg

Standard external battery

1025570	9390-BAT10-S-40x38Ah (250A)	38 Ah	1877x575x773 mm	700 kg
1025572	9390-BAT10-S-200 (250A)	200 W	1877x575x773 mm	1176 kg
1026327	9390-BAT10-S-205 (250A)	205 W	1879x1125x808 mm	1270 kg
1025467	9390-BAT10-280 (250A)	280 W	1879x1125x808 mm	1444 kg
1025468	9390-BAT10-500 (250A)	500 W	1879x1125x808 mm	2188 kg
1025469	9390-BAT10-280 (400A)	280 W	1879x1125x808 mm	1444 kg
1025470	9390-BAT10-330 (400A)	330 W	1879x1125x808 mm	1625 kg
1025471	9390-BAT10-500 (400A)	500 W	1879x1125x808 mm	2188 kg

Battery racks

1026273	9390-RACK10-1x40x200W	200 W	1714x566x1246 mm	985 kg
1026274	9390-RACK10-1x40x280W	280 W	1726x690x1246 mm	1228 kg
1026275	9390-RACK10-1x40x330W	330 W	1726x690x1546 mm	1431 kg
1026276	9390-RACK10-1x40x390W	390 W	1729x690x1546 mm	1587 kg
1026277	9390-RACK10-1x40x500W	500 W	1789x690x1546 mm	1995 kg
1026278	9390-RACK10-2x40x500W	500 W	1714x866x1856 mm	3879 kg
1026279	9390-RACK10-3x40x500W	500 W	1789x690x3666 mm	5865 kg

See runtime page 65

Standard accessories

1021887	External Bypass Switch 60-80kVA (wall-mount)	wall	840x380x130 mm	17 kg
1021888	External Bypass Switch 120 kVA (wall-mount)	wall	1040x560x130 mm	25 kg
1024626	External Bypass Switch 160 kVA (wall-mount)	wall	1040x560x130 mm	25 kg
1025476	SPM-60-2	wall	700x500x250 mm	50 kg
1023540	SPM-80-4	floor	1530x520x788 mm	230 kg
1024687	9390 Tie Cabinet 3x120 kVA	floor	1879x519x808 mm	217 kg
1024506	9390 Tie Cabinet 3x160 kVA	floor	1879x519x808 mm	217 kg

Eaton 9395 UPS

225 - 1100 kVA



An Eaton Green Solution

Due to outstanding green performance, the 9395 has earned the "An Eaton Green Solution"™ label

Advanced power protection for:

- Big data centers and server farms
- Financial services
- Building management
- Telecommunications
- Hospitals



Double conversion UPS

Premium power performance

- Double conversion provides the highest level of protection available by isolating the output power from all input anomalies.
- With a transformer-free design and sophisticated sensing and control circuitry the 9395 UPS delivers an efficiency of up to 94,5%.
- Maximised UPS energy efficiencies with Energy Advantage Architecture (EAA): Variable Module Management System (VMMS) optimises system efficiency at low load levels and Energy Saver System (ESS) allows dramatic increase in UPS efficiency without sacrificing load protection.
- Active power factor correction (PFC) provides 0,99 input power factor and below 3-5% ITHD (depends on utility UTHD), thus eliminating interference with other critical equipment in the same network and enhancing compatibility with generators.
- The UPS is optimized for protecting modern 0,9 p.f. rated IT equipment without the need to oversize.

True reliability

- Hot Sync technology makes possible to parallel up four to six UPSs to increase availability or add capacity. The technology enables load sharing without any communication line, thus eliminating single point of failure.
- The multi-module 9395 can be configured with inherent redundancy – anytime the load is below 50%, the system becomes automatically redundant.
- ABM technology charges batteries only when necessary, preventing batteries corrosion and prolonging batteries service life by up to 50%.

Extensive configurability

- The 9395 is a completely integrated system that incorporates multiple power modules and system switchgear on factory pre-wired bases.
- A multilingual graphical LCD display makes possible to monitor the UPS status easily.
- Wide software and connectivity options provide monitoring, management and shutdown capabilities over network

Cost savings and sustainability

- High system efficiency reduces utility cost, extends battery run times and ensures cooler operating conditions.
- Compared to traditional UPS design, a transformer-free UPS is only 50% the weight and occupies just 60% the footprint, thus reducing impact on shipping.
- The new design requires 50-80% less energy in manufacturing due to less energy needed for testing thanks to Easy Capacity Test.
- Pre-wired configuration reduces cabling busbar costs and installation time. Front accessible design minimizes installation costs and saves valuable data centre space.
- A single technical platform used in Eaton's three-phase UPS products guarantees easy upgrades and similarity in service, thus lowering total cost of ownership.
- More than 90% of the materials can be recycled, further decreasing end-of-life impact.

TECHNICAL SPECIFICATIONS

UPS output power rating (0,9 p.f.)

kVA	225	275	450	550	675	825	900	1100
kW	204	250	408	500	612	750	816	1000

General

Efficiency in double conversion mode (full load)	>94%
Efficiency in double conversion mode (half load)	>93%
VMMS (double conversion)	significantly increased efficiency at low loads
Efficiency in Energy Saver System (ESS)	up to 99%
Distributed parallelling with Hot Sync technology	5 + 1
Internal N+1 redundance capable	in 550 : 275 kVA in 825 : 550 kVA in 1100 : 825 kVA
Inverter/rectifier topology	transformer-free IGBT with PWM
Audible noise	<76 dB; <81 dB (825 and 1100 kVA)
Altitude (max)	1000 m without derating (max 2000 m)

Input

Input wiring	3 ph + N + PE
Nominal voltage rating (configurable)	220/380, 230/400, 240/415 V 50/60 Hz
Input voltage range	+15% / -15%, +10% / -10% for bypass
Input frequency range	45-65 Hz
Input power factor	0,99
Input ITHD	< 3-5% on nominal load, depending on the utility UTHD
Soft start capability	Yes
Internal backfeed protection	Yes, standard

Output

Output wiring	3 ph + N + PE
Nominal voltage rating (configurable)	220/380, 230/400, 240/415 V 50/60 Hz
Output UTHD	<3% (100% linear load); <5% (reference non linear load)
Output power factor	0,9 (e.g. 250 kW at 275 kVA)
Permitted load power factor	0,7 lagging - 0,8 leading
Overload on inverter	10 min 100-110%; 30 sec 110-125%; 10 sec 125-150%; 300 ms >150%
Overload when bypass available	Continuous <115%, 20 ms 1000% Note! Bypass fuses may limit the overload capability

Battery

Type	VRLA, AGM, Gel, Wet Cell			
Charging method	ABM technology or Float			
Temperature compensation	with EMP			
Battery nominal voltage (lead-acid)	480 V (40 x 12 V, 240 cells)			
Charging current / Model	275	550	825	1100
Default A	38	76	114	152
Max* A	83	166	249	332

*Limited by maximum UPS input current rating

Dimensions and weights

225 kVA, 275 kVA	1350 x 880 x 1880 mm (wxdxh)	830 kg
225, 275 kVA redundant	1890 x 880 x 1880 mm	1430 kg
450, 500, 550 kVA	1890 x 880 x 1880 mm	1430 kg
450, 550 kVA redundant	2630 x 880 x 1880 mm	2030 kg
Field upgrade module, 225 or 275 kVA	740 x 880 x 1880 mm	600 kg
675, 825 kVA	3710 x 880 x 1880 mm	2520 kg
675, 825 kVA + 1 redundant	4450 x 880 x 1880 mm	3120 kg
1100 kVA	4450 x 880 x 1880 mm	3120 kg

Accessories

External battery cabinets with long-life batteries, X-Slot connectivity (Web/SNMP, ModBus/Jbus, Relay, Hot Sync, ViewUPS-X remote display), integrated manual bypass for 225-550 kVA

Communications

X-Slot	4 communication bays
Serial ports	1 available
Relay inputs/outputs	5/1 programmable

Compliance with standards

Safety (CB certified)	IEC 62040-1, IEC 60950-1
EMC	IEC 62040-2
Performance	IEC 62040-3

Eaton STS 16



Eaton STS 16

Source transfer system

Power supply redundancy for single-connection circuit equipment.

With the Eaton STS 16, power from 2 independent sources can be supplied to servers and circuit equipment which only have one input power supply.

Redundancy

Only advanced servers are equipped with a dual electrical power supply. A majority of network devices and entry-level servers are single connection which means that they only have one electrical power input. With the Eaton STS, every critical equipment can be connected to a redundant power supply.

Both sources (primary and secondary) are connected, in a very straightforward manner, to the STS in the base of the rack.

The Eaton STS then controls the redundancy of this electrical power supply.

Both sources (primary and secondary) are connected, in a very straightforward manner, to the STS in the base of the rack.

The Eaton STS then controls the redundancy of this electrical power supply. If the primary source fails, transfer to the secondary source is automatic and instantaneous.

Simple and cost-effective

Considering its advanced design, the price of the Eaton STS is highly competitive compared with the 'dual power supply' options available from suppliers of computer equipment.

1U high, the unit can be installed easily within the rack. Five LEDs indicate the status of the sources and the Eaton STS.

Reliability

Designed to provide redundancy as close as possible to the equipment, the Eaton STS deploys a 'break before make' technology based on relays:

- In the event of a short-circuit, the Eaton STS ensures that the fault cannot affect the alternative source, so that power continues to be supplied to the fault-free equipment
- Power is transferred without overlap of the sources in order to prevent any node of reliability
- Even if it suffers a fault, the Eaton STS continues to supply power to the equipment from the remaining available source



Eaton STS 16

- 1 Buzzer stop
- 2 Fault indicator
- 3 Select primary source



STS 16, front view

- 4 Status of the sources
 - source OK
 - source failed
- 5 Eaton STS output
 - power supplied via the primary source
 - supplied via the secondary source

- 1 Circuit breakers
- 2 Output
- 3 Input



STS 16, rear view

TECHNICAL SPECIFICATIONS	STS 16
Nominal current	16 A
Compatibility	With all uninterruptible power supplies which use on-line double conversion technology
Input/output	
Voltage/input frequency	208/220/230/240 V +/- 12% ; 50/60 Hz
Output protection	1 thermal cutout per set of IEC 13 connectors
Performance	
Transfer time	6 ms
Technical standards	
Safety	EN 50091-1
EMC	EN 50022/B, IEC 1000-4
Marking	CE, TÜV/GS/UL
Connection	
Inputs	2 connecting cables with IEC C20 connector (16 A male connector)
Outputs	2 set of 3 IEC C13 connectors - 1 set of 1 IEC C19 connector
Dimensions and weight	
Dimensions H x W x D	430 x 43 x 250 mm
Weight	5 kg
Customer Service & Support	
2 years guarantee	Standard exchange of the product
Communications software and hardware	
A simple and complete mimic diagram	Displays the various status of the sources and the Eaton STS
An 'STS COM' communication port	Of the dry contact type indicates the status of the sources and the Eaton STS: primary source, source OK, fault within the Eaton STS

Part Numbers	STS 16
STS 16	66 028
Set of two 16 A connecting cables IEC female connector / USE-DIN male connector length 1.5 m	66 397
1 cable / IEC 10 A male to IEC 16 A female	66 029



Eaton FlexPDU

Eaton HotSwap MBP

FlexPDU range



HotSwap MBP range



EX RT PDU



Power distribution

The no hassle solution for improving availability and adding flexibility for single phase UPSs.

Eaton FlexPDU

Having the right connectors just where you need them

- FlexPDUs (Power Distribution Units) are flexible mounting multiway socket blocks for easy connection of multiple loads either as free-standing or on rack-mounted UPSs
- FlexPDUs have a large number of sockets (8 French or Schuko sockets, 6 BS sockets or 12 IEC 10A sockets) which fit into a very compact unit (1U - 19")
- FlexPDUs are easy to implement into any type of installation: they can be rack mounted horizontally (1U) or vertically or directly onto all Eaton RT format (rack/tower) UPSs

Eaton HotSwap MBP

High availability for all UPSs up to 3 kVA.

- HotSwap MBP provides a maintenance bypass for all UPSs up to 3 kVA: UPSs can be hot swapped or upgraded without interrupting the power supply
- HotSwap MBP has an IEC16A input connector with retaining clip for compatibility with any UPS now and in the future from Eaton or any other supplier
- There is a range of HotSwap MBP units with different output connectors: French, Schuko, British and IEC sockets - terminal blocks on the HW (Hard-Wired) version
- HotSwap MBP units can be installed as required; at the back, side, top of the UPSs, or rack-mounted (horizontally (1.5U) or vertically)

Eaton EX RT PDU

Socket blocks for single phase UPSs with output terminal blocks.

- Eaton EX RT PDUs (Power Distribution Units) make it easy to connect equipment to single phase UPSs with output terminal blocks (Eaton EX RT, etc)
- Eaton EX RT PDUs provides 8 IEC 10A and 4 IEC 16A sockets on a 2U rack-mounting module
- All the outputs have retaining clips for high reliable connections

Eaton FlexPDU

Eaton HotSwap MBP

- 1 Flexible system for 19" rack-mounting or on Eaton RT UPSs
- 2 French/Schuko/British/IEC 10A sockets
- 3 IEC 16A output for cascading
- 4 IEC 16A input socket
- 5 Retaining clip



Eaton FlexPDU



Eaton HotSwap MBP

- 1 Flexible system for 19" rack-mounting or on Eaton RT UPSs
 - 2 French/Schuko/British/IEC 10A sockets
 - 3 IEC 16A output for cascading
 - 4 IEC 16A input socket
 - 5 Retaining clip
 - 6 Rotary bypass switch
 - 7 Colour coded input and output sockets for connecting the UPS
- NB: hard-wired version available

TECHNICAL SPECIFICATIONS

	Eaton FlexPDU	Eaton HotSwap MBP	Eaton EX RT PDU
Current rating	16 A	16 A	52 A
Voltage rating	220-230-240-250 V		
Installation			
Format	1U (except BS) 19" rack-mounting with multi-position mountings	>1U 19" rack-mounting with multi-position mountings	2U 19" rack
Installation	19" rack horizontal or vertical mounting or on Eaton RT UPSs		19" rack or wall mounting
Dimensions H x W x D	44 x 483 x 80 mm (BS: 52 x 483 x 120 mm)	52 x 483 x 120 mm	89 x 483 x 90 mm
Connection			
Inputs	1 IEC C20 (16A) connector and 2 cables (1 IEC 16A - 16A cable and 1 IEC 10A - 16A cable) for connection to any UPS	FR / DIN / BS / IEC models: 1 IEC C20 (16A) connector and 1 IEC 16A - 16A cable ⁽¹⁾ HW (Hard-Wired): terminal block	Pre-wired 0.5 m cable for connection
Outputs	FR: 8 French sockets + 1 IEC 16A socket DIN: 8 Schuko sockets + 1 IEC 16A socket BS: 6 British sockets + 1 IEC 16A socket (with 2 circuit breakers) IEC: 12 IEC 10A sockets + 1 IEC 16A socket (with 2 circuit breakers) HW: NA	4 French sockets + 1 IEC 16A socket 4 Schuko sockets + 1 IEC 16A socket 3 British sockets + 1 IEC 16A socket (with 1 circuit breaker) 6 IEC sockets + 1 IEC 16A sockets (with 1 circuit breaker) Terminal block	/
Cascading	Yes, IEC 16A output socket (except HW)		
Retaining clips	Retaining clips on the IEC input and output sockets		
Operating conditions, standards and approvals			
Operating temperature	0°C to 45°C continuous		
Performance - Safety - EMC	FR models: IEC 60 884-1 - DIN models: DIN 49 440-1, DIN 49 440-5, DIN 49 440-6 - BS models: BS 1363 IEC models: IEC 60 320-1, EN 60 320-1 - HW models: IEC 60 950, EN 50 091		IEC/EN 60 320-1
Approvals	CE		

1: Use cable kits P/N 66 439 (French/Schuko) or 66 440 (British) for connecting a low power UPS <2.2 kVA (with IEC 10A outputs) - see below.

Part Numbers	Eaton FlexPDU	Eaton HotSwap MBP	Eaton EX RT PDU
FR	FlexPDU 8 FR: 68 435	HotSwap MBP 4 FR: 68 430	/
DIN	FlexPDU 8 DIN: 68 436	HotSwap MBP 4 DIN: 68 431	/
BS	FlexPDU 6 BS: 68 437	HotSwap MBP 3 BS: 68 432	/
IEC	FlexPDU 12 IEC: 68 438	HotSwap MBP 6 IEC: 68 433	Eaton EX RT PDU: 66 857
HW (Hard-Wired)	/	HotSwap MBP HW: 68 434	/
10A French/Schuko cable kit for HotSwap MBP	/	68 439	/
10A British cable kit for HotSwap MBP	/	68 440	/

Cables	Typical applications	Part numbers
2 IEC 10A (IEC C13 - IEC C14) cable kit	Extra output cables for UPSs	66 395
1 IEC 16A (IEC C20 - IEC C19) cable	For connecting to the IEC 16A output of a UPS	66 396
2 16A FR/Schuko cable kit	Connecting Eaton STS 16 to wall sockets	66 397
1 IEC 10A/16A (IEC C14 - IEC C19) cable	connecting Eaton STS to IEC 10A outlets	66 029
1 BS power cable	BS input power cable for 2.2 to 3 kVA UPSs	66 236
1 Swiss power cable	Swiss input power cable for 2.2 to 3 kVA UPSs	66 243



FR DIN/ BS IEC C13 IEC C19 IEC C14 IEC C20
Schuko 10 A 16 A 10 A 16 A



Eaton ePDU



User benefits:

- Eaton ePDUs are designed for mission critical reliability in server applications
- Wide choice of outlets, including UK, Schuko, French, Nema, C13, C19
- Up to 3 types of outlet on custom zero U ePDUs
- Solutions include Basic, Metered, Monitored and Managed technologies
- Choose from a standard set of products, or custom products to meet the most demanding needs.
- Vertical zero U, or horizontal 1U/2U configurations
- Isolation mounting available to provide maximum enclosure integrity
- Multi-option mounting improves installation flexibility. Have confidence that Zero U ePDUs can be adapted to suit any on-site rack configuration.



With today's changing technology, increasing power demands and the need for reliability, data centre professionals require sophisticated equipment to provide and monitor power. Increasing power requirements to rack enclosures means a greater understanding is needed at a server level, rack level and at the entire data centre level in order to manage and control what is happening within the infrastructure.

Eaton intelligent rack-based power distribution solutions ePDUs® provide reliable, flexible, cost effective power distribution as well as a better understanding and management of power consumption in the data centre, together with increased control.

Standard and custom models

Choose from either our standard or custom range of ePDUs:

Standard Range

Standard ePDUs feature our top sellers. These are designed to meet the most popular needs in today's data centre. Our standard range includes:

- Managed units to provide individual outlet monitoring together with outlet Switching and sequencing.
- Advanced Monitored units to provide individual outlet monitoring
- Monitored units to provide branch circuit and rack-level monitoring
- Basic units to provide reliable and flexible power distribution

Our standard units offer either IEC outlets or national outlets for the most popular models.

Custom Range

If you require something special, then we can offer custom Eaton ePDUs tailored to your needs.

Requesting a custom ePDU opens up the broadest portfolio in the industry to you, across all power densities and technologies to satisfy the needs of the most demanding data centre.

Custom ePDUs allow you to specify your power density and monitoring requirements together with inputs and outputs.

Custom ePDUs are available in five different categories: Basic, Metered, Monitored, Advanced Monitored and Managed. You can select from UK, Schuko, French and IEC (C13 & C19) output sockets and local (UK or Schuko), EN 60309, IEC (C14 & C20) or unterminated cords for termination directly to the output terminals of the UPS.

The ePDU portfolio includes an extensive range of vertical Zero U products that do not occupy server space in racks as well as 1U and 2U formats. Environmental monitoring options are also available.

From single to dual corded, five technology options, the broadest power range and the ability to manufacture ePDUs with custom arrangement of outlets (number and type), Eaton ePDUs are distinguished for their quality, dependability and versatility.

Both our standard and custom ePDUs are designed for the specific application with an emphasis on safety and reliability.

Managed ePDU

Managed ePDUs have unprecedented management and monitoring capabilities and enable your energy consumption management to the individual server level.

You can even monitor your consumption down to the individual outlet level to gain a full understanding of your data centre. User definable grouping and sequencing of outlets with time delays allow controlled remote boot-up of servers and equipment. 256-bit encryption ensures secure communication and IPMI and SMASH CLI capability provides harmonised user access to computer hardware and ePDUs.

- Monitor and control individual outlets to manage the efficiency of the data centre at server level
- Comprehensive monitoring to the outlet level (Amps, Volts, Watts)
- Individual outlet switching enables remote reboot of servers
- User defined grouping and sequencing of outlets over multiple ePDUs (for A&B feed)
- Communication using SSL, TELNET, http, https, SNMP, IPMI, SMASH CLI, Serial 256-bit encryption security and in-built firewall
- Email capability for instant alert notification
- SNMP network management protocol enables you to monitor thousands of ePDUs in the network
- Optional temperature and humidity sensors available

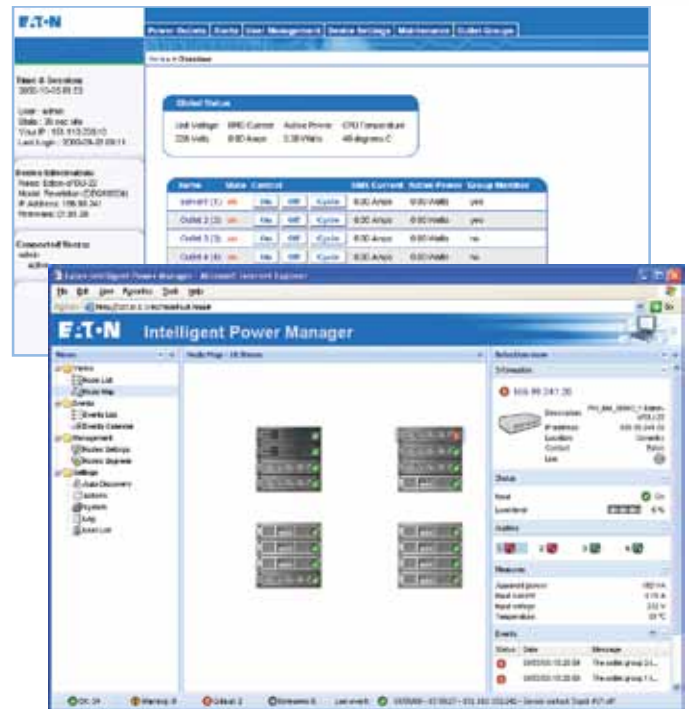

Advanced Monitored ePDU

Advanced Monitored ePDUs offer customers the capabilities of the Monitored ePDUs but with each outlet individually remotely monitored over an Ethernet connection. Advanced monitored ePDUs also include an easy-read digital ammeter for local provisioning and load balancing of servers.

- Monitor current draw over an Ethernet connection
- Easy-read digital ammeter with up to 8 circuits
- Accurate load balancing
- True RMS ammeter provides accurate measurement
- Manual or auto scrolling through circuits



Monitored ePDU

Monitored ePDUs offer customers the ability to remotely monitor the current draw over an Ethernet connection. This allows the user to aggregate the information from thousands of ePDUs in one location. All monitored ePDUs also include an easy-read digital ammeter for local provisioning and load balancing of servers. The multi-channel ammeter allows the monitoring of current on input and each branch circuit to ensure accurate load balancing. The ammeter can manually or automatically scroll through circuits. Eaton Monitored ePDU's offer a reliable, scalable solution for your present and future requirements.

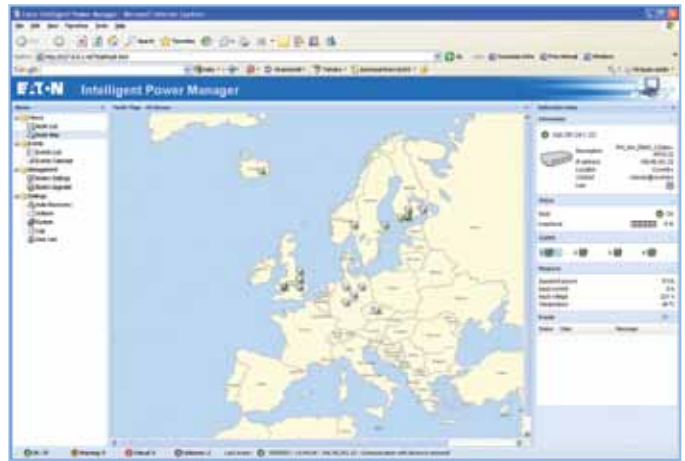

- Monitor current draw over an Ethernet connection
- Easy-read digital ammeter
- Accurate load balancing
- True RMS ammeter provides accurate measurement
- Manual or auto scrolling through circuits



Monitored ePDU

In-Line Monitored ePDU

The In-line Monitored ePDU is a retrofit ePDU to upgrade existing PDUs without power metering, and for installation while live without downtime.

Designed for new or retrofit applications, our in-line monitoring units provide accurate single and dual fed local and remote monitoring solutions. The In-line Monitored ePDUs are available with Ethernet connectivity, as well as the easy-read digital ammeter for local monitoring.

- Adds power distribution monitoring to existing or legacy data centres
- Available in 16A & 32A, single & dual circuits
- 19" horizontal mounting or 0U vertical mounting
- Single or Dual fed – allows A and B feeds to be monitored
- Simple to add to A and B feeds without any downtime
- Fuse-less and breaker-less design: no inline break



Metered ePDU

Custom-made metered ePDUs offer an easy-read digital ammeter for easy start-up and provisioning of servers. The display is large and bright and can be viewed from afar and through perforations in the cabinets. The ePDU assures easy management and monitoring for current requirements and future expansion.

- Local ammeter display enables load balancing and load segmentation
- Easy-read digital ammeter
- True RMS ammeter provides accurate power measurement



Example 2U configurations



High Density and dual input configurations available



Appropriate Breaker protection, or individually fused sockets available



Metered ePDU

Basic ePDU

Designed for reliable and cost effective power distribution, Basic ePDUs have the form factor and outlet choices to meet your needs. All ePDUs, including basic ePDUs, are made of rugged aluminium or steel chassis and incorporate fully shrouded circuit breakers and switches.

- Rugged construction
- Data centre grade components
- Multiple mounting options
- Shrouded circuit breakers and switches
- High-density units available to support blade servers and network switches

Multiple Mounting Options

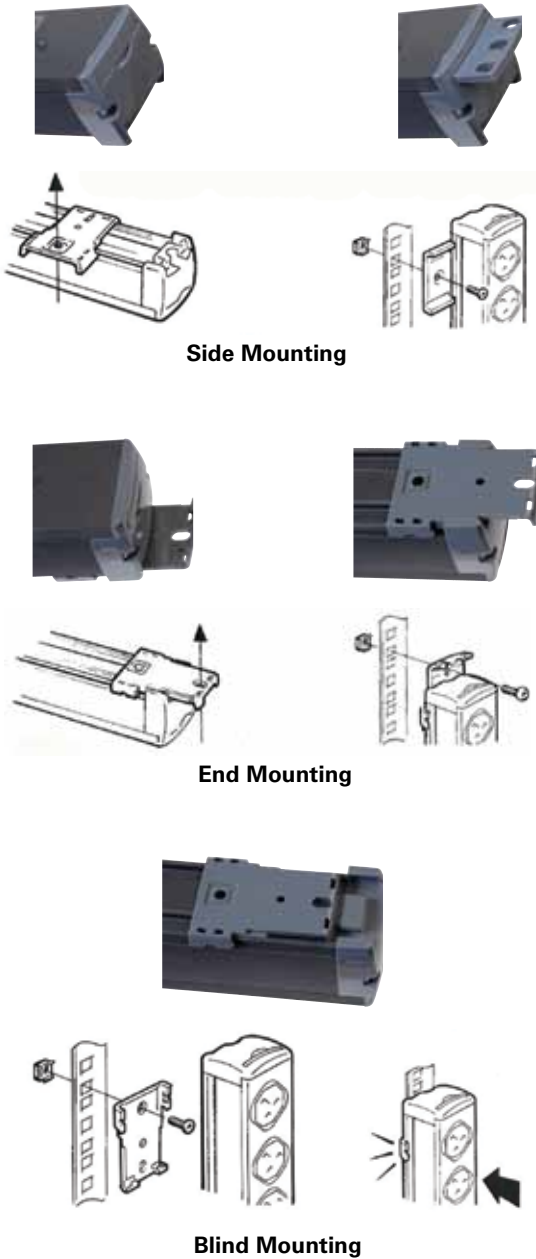

Supervise your ePDU power distribution with Intelligent Power Manager

Intelligent Power® Manager, is a new power monitoring software product from Eaton. It supports Eaton Monitored and Managed ePDU products as well as UPS, so customers can monitor and manage their power distribution via one interface and one IP address.

Integration with virtualization platforms

IPM integration with VMware's vCenter and Microsoft's SCVMM increases productivity and operational responsiveness.

This also makes it possible to trigger vCenter's vMotion™ and SCVMM's Live Migration to transparently move virtual machines from a server affected by a power interruption to an available server on the network, ensuring data integrity and enabling zero downtime.

Benefits:

- Monitor and manage multiple ePDUs and UPS systems over an IP network using a standard web browser
- IPM provides details of ePDU parameters, measurements and settings, from any point in the network, simply using the IP address of each ePDU
- Drill down to individual devices
- User-definable alarms including E-mail and SMS alerts through a single point
- Supervision and management of a whole system through a single user interface
- Configurable views
- Automatic discovery of devices
- Free of charge for up to 10 devices (ePDU or UPS)



Intelligent Power Manager Features and Benefits

Key Feature	Benefit
Browser Based	IE 6, 7 and 8; Firefox 2 and 3; Safari; Chrome. The system can be installed locally, or on a main server and browsed to.
Auto Discovery	Fast installation - automatically detect devices on your network.
Security	Application has multiple password protected access levels and support for secure communications.
Remote access	Interface is web-based which enables remote monitoring and access to systems.
User definable tree structure	Simplifies management of multiple devices over multiple locations through grouping.
User definable graphics view	Helps in visualising physical locations of devices on maps or schematic drawings.
Aggregation of device alarms	Single interface to view all alerts. Minimise response time, reduce time to repair, maximise uptime. Alerts via mobile phones & e-mail.
Aggregated device views	Grouping of multiple 'like' devices simplifies management. Single interface accessible from anywhere on the network through a web browser.
Device firmware management	Reduce set-up and maintenance time of Network Management Cards by mass-configuring parameters and mass-upgrading firmware (not currently functional with ePDU).
Shutdown agent management	Enables safe shutdown of servers.
Automatic updates	Keeps the software at the latest version level.
Support for many device types	UPS and ePDU with network interface devices are visible and their individual web interfaces accessible for editing / configuration from a single view.
Customisable views	Lets users select the most relevant data for fast viewing and sorting on the interface.

TECHNICAL SPECIFICATIONS

Technology	Part number	Form	Rating (A)	Input Type	Outlet type: Qty	Breakers	Dimensions (HxWxD, mm)	Weight (kg)
Managed IEC								
	PW102MA0UC60	0U	10	C14	C13, 16		57x1525x52	10
	PW104MA0UC34	0U	16	IEC309 16A	C13, 16: C19, 4		57x1676x52	10
	PW104MA0UC61	0U	16	C20	C13, 16: C19, 4		57x1676x75	10
	PW107MA0UB61	0U	32	IEC309 32A	C13, 16: C19, 4	2 single pole	57x1837x75	10
	PW104MA1UB44	1U	16	IEC309 16A	C13, 8		45x482x190	5
	PW107MA2UC93	2U	32	IEC309 32A	C13, 16	2 single pole	89x440x267	5,5
Advanced Monitored IEC								
	PW322MI0UC58	0U	32 3P	IEC309 32A 3P	C19, 6	6 Single pole	57x1475x116	10
	PW104AM1UC59	1U	16	IEC309 16A	C13, 8		45x482x150	5
IP Monitored IEC								
	PW102MI0UB95	0U	10	C14	C13, 16		57x838x52	7
	PW104MI0UB96	0U	16	IEC309 16A	C13, 20: C19, 4		57x1097x52	7
	PW104MI0UB97	0U	16	C20	C13, 20: C19, 4		57x1097x52	7
	PW107MI0UB88	0U	32	IEC309 32A	C13, 20: C19, 4	2 single pole	57x1429x91	7
	PW312MI0UC07	0U	16 3Ph	IEC309 16A 3P	C13, 36: C19, 6		57x1682x52	10
Inline Monitored IEC								
	PW104IM0UC05	0U 19"	16	IEC309 16A	IEC309 16A	None	57x436x52	6,5
	PW107IM0UC04	0U 19"	32	IEC309 32A	IEC309 32A	None	57x436x52	6,5
	PW322IM0UC17	0U 19"	32 3P	IEC309 32A 3P	IEC309 32A 3P	None	57x436x75	6,5
	PW107IM0UB81	0U 19"	2x16	2x IEC309 16A	2x IEC309 16A	None	57x436x75	6,5
	PW344IM0UC18	0U 19"	2x32 3Ph	2x IEC309 32A 3Ph	2x IEC309 32A 3Ph	None	57x573x75	6,5
Basic IEC								
	ePBZ03	0U	16	C20	C13, 16		48x635x60	1,5
	ePBZ05	0U	10	C14	C13, 16		48x635x60	1,4
	ePBZ32	0U	16	IEC309 16A	C13, 20: C19, 4		45x768x50	1,7
	ePBZ33	0U	16	C20	C13, 20: C19, 4		45x768x50	1,6
	ePBZ31	0U	32	IEC309 32A	C13, 20: C19, 4	2 single pole	45x921x50	2,7
	PW312BA0UC07	0U	16 3Ph	IEC309 16A 3P	C13, 36: C19, 6		57x1400x52	10
	PW322BA0UC56	0U	32 3Ph	IEC309 32A 3P	C13, 3: C19, 6	6 single pole	57x1200x116	10
	PW322BA0UC57	0U	32 3Ph	IEC309 32A 3P	C19, 6	6 single pole	57x1135x116	10
	ePBZ06	1U	16	C20	C13,10: C19,2		43x439x59	1,6
	ePBZ04	1U	16	C20	C13,12		43x439x59	1,6
	ePBZ01	0U	10	C14	C13, 8		43x439x59	1,4
	ePBZ02	0U	10	C14	C13, 12		43x439x59	1,4
Schuko socket								
Technology	Part number	Form	Rating (A)	Input Type	Outlet type: Qty	Breakers	Dimensions (HxWxD, mm)	Weight (kg)
Basic Schuko	ePBZ25	0U, 19"	16	Schuko	schuko, 4		45x444x50	1,4
Basic Schuko	ePBZ26	0U, 19"	16	Schuko	schuko, 8		45x444x50	1,5
Basic Schuko	ePBZ27	0U	16	Schuko	schuko, 12		45x667x50	2
Monitored Schuko	PW104MI0UC72	0U	16	Schuko	schuko, 16		57x1328x52	8
Monitored Schuko	PW102MI0UC73	0U	10	C14	schuko, 16		57x1328x52	8
Monitored Schuko	PW104MI0UC74	0U	16	C20	schuko, 20: C19, 4		57x1850x52	8
Monitored Schuko	PW107MI0UC75	0U	32	IEC309 32A	schuko, 20: C19, 4	2 single pole	57x1860x116	10
Monitored Schuko	PW104MI0UC76	0U	16	IEC309 16A	schuko, 20: C19, 4		57x1850x52	8
Managed Schuko	PW104MA0UC77	0U	16	Schuko	schuko, 16		57x1425x75	10
Managed Schuko	PW102MA0UC78	0U	10	C14	schuko, 16		57x1425x75	10
Managed Schuko	PW104MA0UC79	0U	16	C20	schuko, 16: C19, 4		57x1695x75	10
Managed Schuko	PW107MA0UC80	0U	32	IEC309 32A	schuko, 16: C19, 4	2 single pole	57x1840x116	10
Managed Schuko	PW104MA0UC81	0U	16	IEC309 16A	schuko, 16: C19, 4		57x1695x75	10

French socket

Technology	Part number	Form	Rating (A)	Input Type	Outlet type: Qty	Breakers	Dimensions (HxWxD, mm)	Weight (kg)
Basic French	ePBZ28	0U, 19"	16	FR	FR, 4		45x444x50	1,4
Basic French	ePBZ29	0U, 19"	16	FR	FR, 8		45x444x50	1,5
Basic French	ePBZ30	0U	16	FR	FR, 12		45x667x50	2
Monitored French	PW104MI0UC82	0U	16	FR	FR, 16		57x1328x52	8
Monitored French	PW102MI0UC83	0U	10	C14	FR, 16		57x1328x52	8
Monitored French	PW104MI0UC84	0U	16	C20	FR, 20: C19, 4		57x1850x52	8
Monitored French	PW107MI0UC85	0U	32	IEC309 32A	FR, 20: C19, 4	2 single pole	57x1860x116	10
Monitored French	PW104MI0UC86	0U	16	IEC309 16A	FR, 20: C19, 4		57x1850x52	8
Managed French	PW104MA0UC87	0U	16	FR	FR, 16		57x1425x75	10
Managed French	PW102MA0UC88	0U	10	C14	FR, 16		57x1425x75	10
Managed French	PW104MA0UC89	0U	16	C20	FR, 16: C19, 4		57x1695x75	10
Managed French	PW107MA0UC90	0U	32	IEC309 32A	FR, 16: C19, 4	2 single pole	57x1840x116	10
Managed French	PW104MA0UC91	0U	16	IEC309 16A	FR, 16: C19, 4		57x1695x57	10

UK socket

Technology	Part number	Form	Rating (A)	Input Type	Outlet type: Qty	Breakers	Dimensions (HxWxD, mm)	Weight (kg)
Basic UK	ePBZ20	0U, 19"	13	UK	UK, 4		55x444x47	1,4
Basic UK	ePBZ21	0U, 19"	13	UK	UK, 6		55x444x47	1,5
Basic UK	ePBZ22	0U	13	UK	UK, 8		55x591x47	1,9
Basic UK	ePBZ23	0U	13	UK	UK, 10		55x718x47	2
Basic UK	ePBZ24	0U	13	UK	UK, 12		55x845x47	2,2
Monitored UK	PW103MI0UC62	0U	13	UK	UK, 16		57x1328x52	8
Monitored UK	PW102MI0UC63	0U	10	C14	UK, 16		57x1328x52	8
Monitored UK	PW104MI0UC64	0U	16	C20	UK, 20: C19, 4		57x1850x52	8
Monitored UK	PW107MI0UC65	0U	32	IEC309 32A	UK, 20: C19, 4	2 single pole	57x1860x116	10
Monitored UK	PW104MI0UC66	0U	16	IEC309 16A	UK, 20: C19, 4		57x1850x52	8
Managed UK	PW103MA0UC67	0U	13	UK	UK, 16		57x1425x75	10
Managed UK	PW102MA0UC68	0U	10	C14	UK, 16		57x1425x75	10
Managed UK	PW104MA0UC69	0U	16	C20	UK, 16: C19, 4		57x1695x75	10
Managed UK	PW107MA0UC70	0U	32	IEC309 32A	UK, 16: C19, 4	2 single pole	57x1840x116	10
Managed UK	PW104MA0UC71	0U	16	IEC309 16A	UK, 16: C19, 4		57x1695x75	10

Intelligent Power Software

Intelligent Power Software is a suite of productivity tools for power management from Eaton. It greatly simplifies the supervision of power conditions and devices in today's enterprise environment, scaling effortlessly from local area networks with a few UPSs and ePDUs to global enterprise-wide supervision of critical power systems. Administrators will also value the many automatic functions of Intelligent Power Software and ease of installation, which requires just a few clicks and a couple of minutes. Once the software starts, it will automatically discover manageable equipment.

The architecture of Intelligent Power Software is very flexible. Completely network-based communications makes the server part very suitable for virtualization, and the web interface allows access from any device with a browser, anywhere in the network. The Web 2.0-compliant dynamic interface presents database content in text, graphs and colours, highlighting the essential points. The software can take automatic action as well. Events can be set to trigger email sending, notifications and command execution. This way alarms with exact data reach the right people in seconds, giving maximum time for action to prevent downtime, reduce mean time to repair and minimise the impact.



Intelligent Power Software snapshot

- Intelligent Power Manager for monitoring and managing power equipment in IT environments
- Intelligent Power Protector for graceful shutdown of operating systems
- Intuitive, Web 2.0-based user interface
- Compatible with Eaton and other manufacturers' UPSs as well as Eaton's ePDU products and environmental sensors
- Reduces total cost of ownership for the whole monitoring system

Benefits for virtualised environments

- IPM integration with VMware's vCenter and Microsoft's SCVMM streamlines daily management work and increases productivity.
 - View critical power information on UPS, ePDUs and environmental sensors from the vCenter dashboard
 - Integrate power alarms to vCenter alarm handling and event logging
 - Instantly access critical information such as UPS battery status, load levels and alarms
- IPM can also be configured to trigger vCenter's vMotion™ and SCVMM's Live Migration to transparently move virtual machines from a server affected by a power interruption to an available server on the network, ensuring data integrity and enabling zero downtime.
- Intelligent Power Protector software can perform an automatic orderly shutdown of VMware, Hyper-V, Xen and KVM hypervisors and their guest operating systems in case of a prolonged power failure that threatens to exceed battery backup time.



Features and Benefits

Key Feature	Benefit
Browser Based	IE 6, 7 and 8; Firefox 2 and 3; Safari; Chrome. The system can be installed locally, or on a main server and browsed to.
Auto Discovery	Fast installation - automatically detect devices on your network.
Security	Multiple password protected access levels and support for secure communications.
Remote access	Interface is web-based which enables remote monitoring and access to systems.
Customisable views	Lets users select the most relevant data for fast viewing and sorting on the interface.

Intelligent Power Manager

Intelligent Power Manager is a productivity tool for administrators of several power devices and shutdown applications. It delivers the big picture and highlights key factors by concentrating information from multiple sources and displaying it in a single view. It also centralizes alarm propagation making sure that important events are brought to those who need to know.

Intelligent Power Manager simplifies many routine maintenance tasks, including its own updates. It has an automatic update function which will notify the operator of available upgrades, download and install them. In addition to that, it also checks if there are new versions of shutdown software. Mass upgrade and configuration of cards and applications saves a lot of valuable operator time and reduces the chance of human error.

Features:

- Easy monitoring of up to hundreds of power and environmental devices
- User-definable tree structure enables grouping, access and management of multiple devices in several locations
- Minimizes the effort required in power management system maintenance through mass configuration and firmware management
- Manages all Intelligent Power software instances in the network



Global view

From a local to a global view

Intelligent Power Manager scales easily from a local area network to a global view, keeping an eye on power conditions and equipment status. In addition to the default maps, it's possible to upload more maps, floor plans and other images. There can be separate views for multiple geographical areas and buildings.

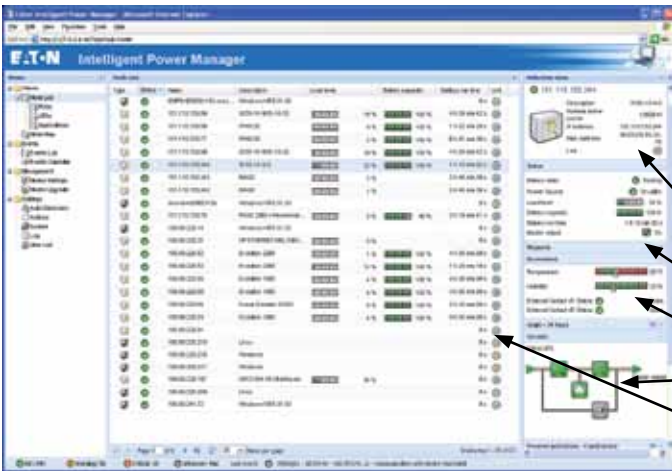

Main list view

Key parameters at a glance

With Intelligent Power Manager list view, the key operational parameters of multiple devices can be seen at a glance. Users can create their own views and apply several different filters, such as location, equipment type, function and so forth. Activating an entry provides more detailed data in the information panes:

- Identification of the device, including equipment type, serial number and user-defined information
- Operational status
- Readings from optional environmental probe
- Synoptic view of power flow
- For each node, there is a hyperlink to the web interface of that device

Graphing tools

List and map views give an excellent real-time snapshot of a large number of devices, but very often time series data is needed for analysis, planning and problem mitigation. Intelligent Power Software has powerful graphing tools which help in visualising large amounts of data stored in its database. The user can choose which data is graphed and which timescales are used. Exact values are displayed when the pointer is moved over the graph area.

Ordering information

Intelligent Power Manager manages up to 10 devices at no charge. In order to raise this limit and enable management of 100 or more devices you need to purchase a full license and enter the corresponding license key.

Intelligent Power Manager	
Base license (up to 10 devices)	Available on the CD bundled with each UPS or free of charge from the web: www.eaton.com/powerquality
Silver license (up to 100 devices)	66 925
Gold license (unlimited number of devices)	66 926

Intelligent Power Protector

Uninterruptible power systems are designed to protect your network devices from power anomalies, including surges, sags and frequency variations. But when the power goes out for longer than your available battery runtime Intelligent Power Protector software facilitates automatic, graceful shutdown of computers, servers and network devices powered by a UPS. It saves all work-in-progress and ensures data integrity. Intelligent Power Protector has also monitoring and alarm handling capabilities making it a complete solution for a single UPS.

Features:

- Graceful shutdown of operating systems in case of an extended power failure or other condition that threatens the availability of IT equipment
- Supports Eaton Powerware and Pulsar series UPS through network, RS232 serial and USB communication
- Silent unattended installation option
- Manageable with Intelligent Power Manager
- Provided free of charge

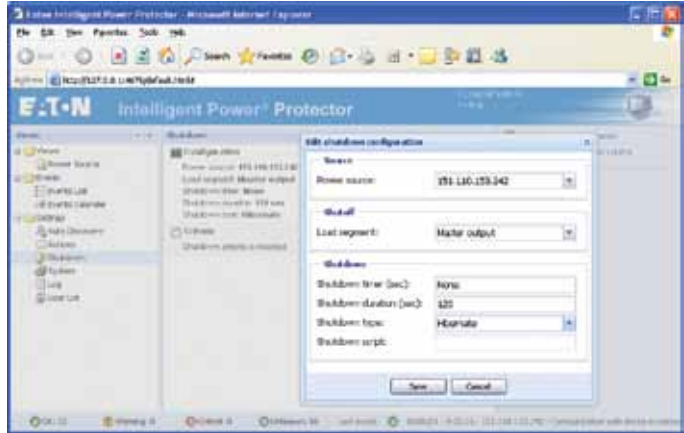

Shutdown settings

Comprehensive choice

Intelligent Power Protector has comprehensive choices for shutdown triggers, timings and modes. User can choose whether the operating system should shut down, hibernate, power off or run a custom script. The start of shutdown can be based on an instant event, delay or remaining runtime on the UPS.



Powered applications

Managing various setups

There could be hundreds of UPSs in a network, each one powering tens of servers running shutdown software. Managing that kind of setup could easily become a nightmare, especially because new computers are added and old ones moved all the time. Intelligent Power Manager comes to the rescue by clearly showing which Protectors are connected to a particular UPS.



Calendar view

Calendar view

Calendar view shows event types per day and moving the pointer over will show how many events of various types have occurred on any given date. Selecting a day will show a detailed log of events with time stamps and descriptions. Statistics can be calculated for any given period of time.



Event configuration

Event configurations

Intelligent Power Software can perform actions when events of any given type or criticality occur. These actions include notifications on computer screens, command execution and email sending. To limit the amount of emails, it is possible to combine several events into a single message. This is a particularly valuable feature in large installations.

Connectivity Options

ConnectUPS Web/SNMP card is a complete UPS monitoring, control and shutdown solution in a networked IT environment. In case of alert the Web/SNMP card can notify users and administrators through e-mail and SNMP traps. In case of a prolonged power failure the protected computer systems can be shut down in a graceful manner with Intelligent Power Protector software. The unique three-port switching hub on the X-Slot model provides additional network connections.

ConnectUPS-X

P/N 116750221-001 for Eaton 9155, 9355, 9390, 9395, BladeUPS.

ConnectUPS-E

P/N 116750223-001 is an external model that is connected to a serial port on a UPS. It supports Eaton 9130, 9155, 9355, 9390 and 9395 UPS (requires cable 1023247).

ConnectUPS-MS Network Management Card

P/N 103006826 provides Web 2.0 interface, SNMP v 1 and v 3 compatibility and IP v 6 support for Eaton 5130, 9130 and 9135 UPS.

Eaton Network Management Card Minislot

P/N 66102 provides Web 2.0 interface, SNMP v 1 and v 3 compatibility and IP v 6 support for Eaton Evolution, EX, MX, EX RT and 5PX UPS.



Environmental Monitoring Probe (EMP) adds temperature, humidity and two contact closure monitoring capability to ConnectUPS Web/SNMP cards. It is well suited for monitoring rack temperature and door status, as well as battery temperature. Operating system shutdown can be triggered if user defined thresholds are exceeded or contact closure status changes. P/N 116750224-001 for all UPSs with a ConnectUPS card installed.

P/N 66846 for all UPS with a 66102 card installed.



Relay/AS400 cards are an easy connection to IBM AS/400 series computers as well as industrial and building management systems. P/N 1018460 for Eaton 9155, 9355, 9390, 9395, BladeUPS. P/N 1014018 for Eaton 9130.

P/N 103006828 for Eaton 5130 and 9135.

P/N 66104 for Eaton Evolution, EX, MX, EX RT and 5PX.



X-Slot ModBus card connects the UPS to industrial and building management systems using ModBus/JBUS RTU protocol. P/N 103005425-5591 for Eaton 9155, 9355, 9395, BladeUPS.

iNMC card P/N 66103 offers ModBus RTU in addition to Web and SNMP for Eaton Evolution, EX, MX, EX RT, 5130 and 9135 UPS.

PXGX UPS card P/N 103007974-5591 offers ModBus TCP as well as Web and SNMP interfaces for 9155, 9355, 9390 and 9395 UPS.



ViewUPS-X remote display is an LCD panel that lets users view the status of the UPS from as far as 100 m. ViewUPS-X has also four status LEDs and an alarm sound. The display is bundled with a dedicated X-Slot card that also powers the display through the communication cable. In addition to the remote display connection the card has also a SELV isolated relay port for connection to monitoring systems and AS/400 computers.

P/N 1027020 for 9155, 9355, 9390, 9395, BladeUPS.



Eaton Enclosures



Superior rack enclosures for IT equipment

IT availability and reliability are critical issues in today's demanding environments, so it is important to ensure stable conditions for your server and software systems.

Eaton introduces a range of enclosures and accessories for your network closets, computer rooms and data centres.

Designed specifically for IT applications, this 42U x 600 mm (w) x 1000 mm (d) modern enclosure offers strength, stability and a vendor-neutral environment to house IT equipment.

The Eaton Enclosure allows for ultimate buying flexibility to create additional space, and the 16-fold unique frame design delivers the highest dimensional stability and load bearing capability. The enclosure is complemented with a range of cable management, cooling and power distribution accessories to enable you to tailor your enclosures to your specific application.

Features

- Designed specifically for IT applications
- Universal server platform (EIA 310-D)
- Full line of accessories
- Excellent heat dissipation
- Strong frame structure

Reliable Power distribution for:

- Data centres
- MDC/IDC
- Wiring closets
- Office environments
- Central offices
- Co-location and application environments



Eaton Enclosures

Specifications

- Frame system – multi-fold steel frame design for strength and rigidity
- No horizontal or vertical supports, keeping entire structure open for equipment and cable management
- Perforated roof with four 114 mm holes with grommets for overhead cable management
- Torsion-free structure
- Multiple internal surfaces and mounting points
- Maximum internal volume for footprint
- External access to all installation points for doors and walls
- Maximum load bearing capacity – 907 kg

External Surfaces – Doors and Walls

- Doors can be easily removed or reversed
- Sidewalls can be screwed on or locked in place
- Internal door hinge and lock points offer maximum security
- Door stiffener stabilizes door and provides additional mounting surfaces
- Maximum perforated door area meets or exceeds server manufacturer specifications for air flow
- Ground studs on all surfaces
- External surfaces do not affect load bearing capacity – same ratings with or without side walls
- Door handle provides customised locking solutions and simple ID tag capability
- Split rear doors to maximise floor space availability

Vertical Mounting Rails

- Designed to meet EIA-310-D standards
- Fully depth-adjustable to maintain load capacity regardless of rail positioning
- Floating isolation system – vertical rails are not secured to frame members or lateral support channels – can be adjusted independently
- “Z”-shaped, multi-fold profile offers high load-bearing capacity and multiple mounting surfaces
- “U” markings on front and rear near surfaces of each rail for ease of installation

Key Accessories

- Sidewalls - for security and thermal control
- Baying kits - for universal flexibility in joining enclosures together
- Shelves – (482 mm)
68 kg – 113 kg capacities
- Casters - for ease of movement on flat surfaces
- Tool-less cable management hardware reduces installation time and costs
- Bolt-down kits - for securing cabinets in place
- Tool-less blanking panels - to control airflow and improve cooling efficiency
- Plinths, roof fans and pull out stabilisers
- Compliment your Eaton rack enclosure with Eaton Enclosure Power Distribution Units - ePDUs
- For a full list of accessories and ePDUs please speak with your local Eaton representative

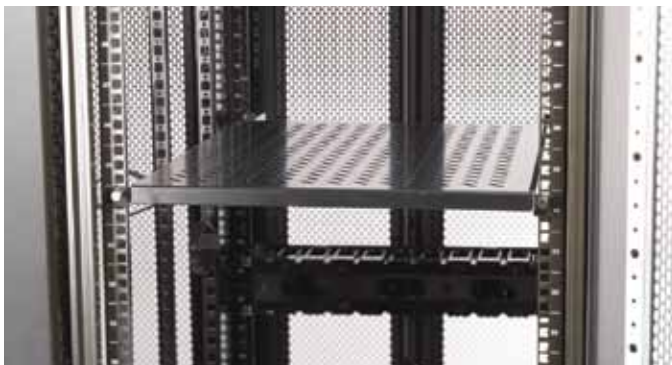

Description	Dimensions mm	Weight kg	Shipping Dimensions mm	Shipping Weight kg	Part Number
No Sides or Casters	2000x600x1000	99	2160x800x1200	116	1052734
With Sides, no Casters	2000x600x1000	116	2160x800x1200	133	1052735
No Sides, with Casters	2000x600x1000	104	2160x800x1200	121	1052736
With Sides and Casters	2000x600x1000	121	2160x800x1200	138	1052737

UPS Runtime Tables

BladeUPS

Load	#42U Racks	4 kW	8 kW	12 kW	24 kW	36 kW	48 kW	60 kW		
1 x BladeUPS (12 kW Internal battery)	6	6	1	23	8,7	4,7				
+ 1 External Battery Module	9	9	1	41	17,6	9,5				
+ 2 External Battery Module	12	12	1	65	28	17				
+ 3 External Battery Module	15	15	1	93	43	27				
+ 4 External Battery Module	18	18	1	119	55	34				
2 x BladeUPS (12 kW N+1 Internal battery)	12	18	1	44	23	13,6				
+ 1 External Battery Module	18	24	1	85	41	27				
+ 2 External Battery Module	24	30	1	137	65	41				
+ 3 External Battery Module	30	36	1	198	93	59				
+ 4 External Battery Module	36	42	2	257	119	76				
3 x BladeUPS (24 kW N+1 Internal battery)	18	24	1		34	23	8,7			
+ 1 External Battery Module	27	33	1		34	41	17,6			
+ 2 External Battery Module	36	42	2		102	65	28			
+ 3 External Battery Module	45	51	2		147	93	43			
+ 4 External Battery Module	54	60	2		190	119	55			
4 x BladeUPS (36 kW N+1 Internal battery)	24	30	1			30	13,6	7,3		
+ 1 External Battery Module	36	42	2			56	27	14,7		
+ 2 External Battery Module	48	54	2			89	41	24		
+ 3 External Battery Module	60	66	2			128	59	37		
+ 4 External Battery Module	72	78	2			165	76	47		
5 x BladeUPS (48 kW N+1 Internal battery)	30	36	1				19	10	6,6	
+ 1 External Battery Module	45	51	2				34	21	13,3	
+ 2 External Battery Module	60	66	2				54	31	23	
+ 3 External Battery Module	75	81	2				77	48	35	
+ 4 External Battery Module	90	96	3				98	61	44	
6 x BladeUPS (60 kW N+1 Internal battery)	36	42	2				23	13,5	8,7	6,2
+ 1 External Battery Module	54	60	2				41	27	17,6	12,6
+ 2 External Battery Module	72	78	2				65	41	28	21,6
+ 3 External Battery Module	90	96	3				93	59	43	33
+ 4 External Battery Module	108	114	3				119	76	55	42

* Note: each UPS requires the same number of external batteries

Time in minutes

9155 and 9355 8-15 kVA runtimes

Runtimes for UPS with internal batteries (UPS load with typical 0.7 p.f.)

Battery	Qty	3	4	5	6	7	8	9	10	11	12	13	14	15	kVA
7 Ah 12 V	1 x 32	36	26	20	15	12	10	7	6	-	-	-	-	-	min
9 Ah 12 V	1 x 32	42	32	24	21	16	15	12	10	9	8	7	6	5	min
7 Ah 12 V	2 x 32	86	66	46	38	33	28	23	20	16	15	13	12	10	min
9 Ah 12 V	2 x 32	95	74	61	44	38	33	29	25	22	20	18	16	15	min

Runtimes for UPS with external battery cabinet

Battery	Qty	3	4	5	6	7	8	9	10	11	12	13	14	15	kVA
7 Ah 12 V	3 x 32	130	100	81	68	57	44	39	35	27	24	22	20	18	min
7 Ah 12 V	4 x 32	200	133	108	91	78	69	61	47	40	35	32	29	27	min
7 Ah 12 V	5 x 32	250	182	141	114	95	81	70	61	53	47	43	39	36	min
7 Ah 12 V	6 x 32	316	230	178	144	120	102	89	78	67	60	54	50	45	min
7 Ah 12 V	7 x 32	385	280	217	176	146	124	106	93	82	73	66	60	55	min
7 Ah 12 V	8 x 32	458	333	258	209	174	147	126	110	97	87	79	72	66	min

UPS Runtime Tables

Runtimes for UPS with internal batteries (4 x 36 pcs 9 Ah) and external battery cabinet(s) with 24 Ah batteries (one external battery cabinet can fit 2 strings of 24 Ah batteries)

Internal Battery		External Battery										
Battery	Qty	Battery	Qty	5	10	15	20	25	30	35	40	kVA
9 Ah 12 V	4 x 36	24 Ah 12 V	1 x 36	268	113	77	56	43	34	25	20	min
9 Ah 12 V	4 x 36	24 Ah 12 V	2 x 36	402	175	115	84	69	57	47	38	min
9 Ah 12 V	4 x 36	24 Ah 12 V	3 x 36	555	243	154	121	90	75	63	54	min
9 Ah 12 V	4 x 36	24 Ah 12 V	4 x 36	> 10 h	318	197	147	123	100	77	66	min

External battery (Panasonic LC-X1224AP) with four internal strings back up table for UPS ratings 20-40 kVA, p.f. 0.7 (typical IT server/computer load).

Runtimes for UPS with internal batteries (4x 36pcs 9Ah) and external battery cabinet(s) with 110W batteries (one external battery cabinet can fit 2 strings of 24 Ah batteries)

Internal Battery		External Battery										
Battery	Qty	Battery	Qty	5	10	15	20	25	30	35	40	kVA
9 Ah 12 V	4 x 36	110 WPC12 V	1 x 36	318	132	82	62	47	41	32	25	min
9 Ah 12 V	4 x 36	110 WPC12 V	2 x 36	518	225	138	104	81	66	50	42	min
9 Ah 12 V	4 x 36	110 WPC12 V	3 x 36	> 10 h	318	204	147	114	95	77	66	min
9 Ah 12 V	4 x 36	110 WPC12 V	4 x 36	> 10 h	430	266	198	153	124	103	87	min

External battery (CSB HRL 12110W) with four internal strings back up table for UPS ratings 20-40 kVA, p.f. 0.7 (typical IT server/computer load).

9390 40-160 kVA, external battery capacity

Battery configuration	UPS load with typical load p.f.0,8						
	40	60	80	100	120	160	kVA
1xBAT (HR250)	30	17	10	-	-	-	min
2xBAT (HR250)	73	44	30	22	15	10	min
3xBAT (HR250)	128	72	51	35	30	21	min
4xBAT (HR250)	180	106	75	54	41	30	min
2xBAT (HR305)	39	22	15	-	-	-	min
2xBAT (HR305)	96	57	40	25	22	15	min
3xBAT (HR305)	160	96	64	45	37	26	min
4xBAT (HR305)	220	136	96	72	55	40	min
1xBAT (HRL12280)	40	24	15	10	7	-	min
2xBAT (HRL12280)	100	57	33	30	24	15	min
3xBAT (HRL12280)	144	96	69	50	30	28	min
1xBAT (HRL12330)	47	30	20	13	10	6	min
2xBAT (HRL12330)	116	72	50	36	30	20	min
3xBAT (HRL12330)	163	105	84	60	48	35	min
1xBAT (HRL12500)	80	49	35	24	18	12	min
2xBAT (HRL12500)	196	121	81	60	48	34	min
3xBAT (HRL12500)	266	178	121	92	80	57	min
1xBAT (NSB125)	87	53	36	27	20	12	min
2xBAT (NSB125)	200	128	91	69	55	38	min
3xBAT (NSB125)	305	200	145	115	94	64	min

9395 225-275 kVA, external battery capacity

Battery configuration	UPS load with typical load p.f. 0,9					
	160	200	225	250	275	kVA
1xBAT CSB HRL 500	9	5	-	-	-	min
2xBAT CSB HRL 500	29	20	17	14	12	min
3xBAT CSB HRL 500	49	37	32	28	24	min

*Load power factor 0,9

Battery configuration	UPS load with typical load p.f.0,8					
	160	200	225	250	275	kVA
1xBAT CSB HRL 500	12	7	5	3	-	min
2xBAT CSB HRL 500	34	25	20	17	15	min
3xBAT CSB HRL 500	57	43	37	33	28	min

The battery backup table is given with end voltage 1.70 VPC and temperature +25°C.
The batteries are fully charged and measured after minimum (5) full discharge cycles.

In addition to the wide product portfolio Eaton has a comprehensive range of service packages to match different type of maintenance needs and budgets.

For assistance with your power quality needs, contact your local Eaton service and sales representatives.

www.eaton.com/powerquality

Eaton, Powerware, ABM, BladeUPS, ePDU, Hot Sync, Intelligent Power and An Eaton Green Solutions are trade names, trademarks, and/or service marks of Eaton Corporation or its subsidiaries and affiliates. All other trademarks are the property of their respective owners.

© 2011 Eaton Corporation
All Rights Reserved
Printed in Finland
00BROC1018124 rev C
May 2011

