

Good. Safe. Yellow.

Basic Knowledge
Compact



Klingspor products are marked with the oSa label



What does oSa mean?

In a host of applications grinding and cutting require very high peripheral speeds from the rotating abrasive product. These products must therefore be particularly safe so as to stand up to the extreme mechanical and thermal stress.

Regrettably there are no globally binding safety requirements for abrasive products.

This is why responsible manufacturers of abrasive products from a number of European countries set up the Organization for the Safety of Abrasives (oSa) in 2000 and thus setting a clear signal against inferior and dangerous products.

The user recognises these quality grade products from the oSa trade name. They signify to the manufacturer and trader a reduced liability risk, a market and competitive benefit and an image gain.

As a part of their in-house quality management system, the manufacturers see to it that the exact provisions are kept to and that only safe, high quality abrasive products are produced and marketed. The fact that the oSa – Organization for the Safety of Abrasives issues the worldwide protected oSa trademark to members is confirmation of this internal commitment. The oSa label does not mean that the Organization for the Safety of Abrasives or its institutions assume any liability of the designated products.





Basic Knowledge Compact

Content

Coated Abrasives	4
Specific Abrasives	6
Non-Woven Web	8
Abrasive Mop Discs	10
Abrasive Mops	12
Kronenflex®	14
Quick Change Discs	16
Carbide Burrs.....	18
Diamond Tools.....	20
Flexible Abrasives	22
Wire brushes	24

Service

Klingspor offers the complete technical support - e.g. help for product selection, trainings or fault analytics on location.

Coated Abrasives

In general coated abrasives are chosen by two main criteria: type of grain and type of backing.

Type of grain

The suitable type of grain depends on the material to be processed. In principle the tougher the material to be ground the tougher the abrasive grain required to give the best results. The following chart shows the popular types of grain.

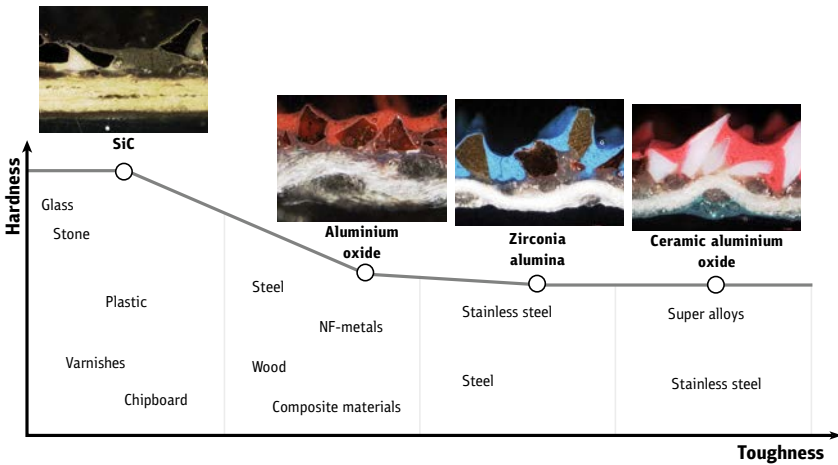

An example of the cost versus life time and aggression in a metal working scenario. For a better understanding see the next page regarding wear behavior.

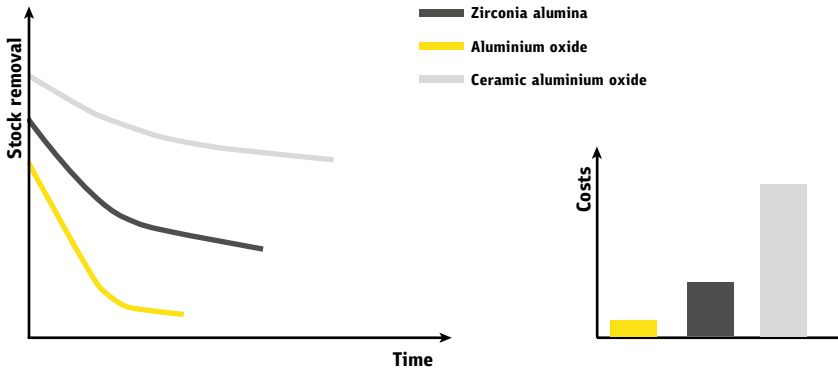

The types of grain differ not only in aggressiveness and in price, but rather in the **wear behavior**:

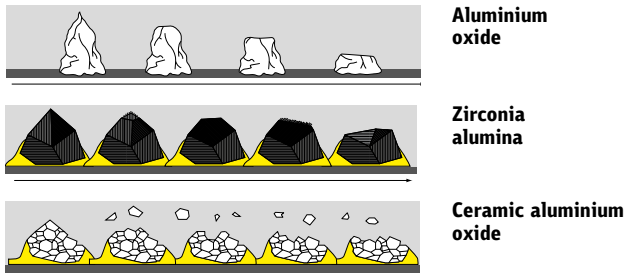

Zirconium and Ceramic are both very effective abrasive grain type due to their re-sharpening ability through the grinding process. Ceramic with its micro crystalline structure creates new cutting edges throughout the wear process, offering the longest life time and highest aggression. Followed by Zirconium which also re-sharpens through the grinding process. Although more expensive, these abrasive grains offer process cost reduction due to the speed of removal and additional life time.

Backing

Backing selection is always relevant to the geometry of the workpiece. **Flexible** backing for high profiled work pieces and more robust **tear resistant** for flat surface grinding. For economy, paper would be the first choice followed by cloth and polyester for durability and stability. Film and fibre offer the best stability and durability for rotating coated abrasives.

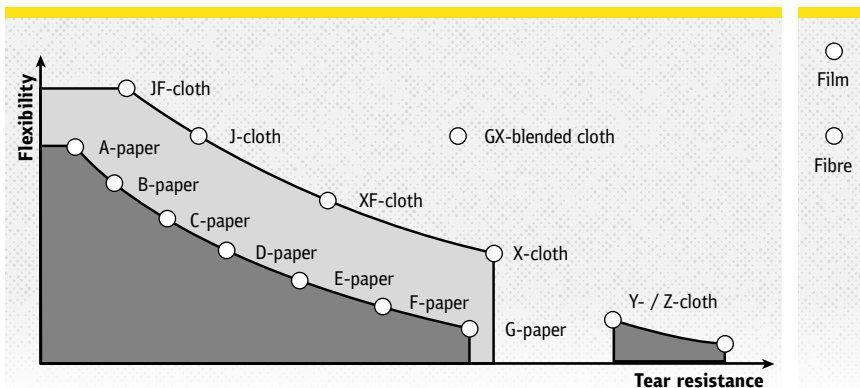

Specific Abrasives

A number of additives and special structures can be used to enhance abrasive performance:

- ▶ Multibond
- ▶ Stearate
- ▶ Advanced Coating Technologie (ACT)
- ▶ Agglomerate, noppex, cork
- ▶ Polycotton

Multibond

Whilst grinding, heat is produced due to friction. This can be problematic on high alloy materials. With the addition of multibonds, this can dramatically reduce the heat build-up keeping the abrasive grain cool and enhancing life time but also reduce the effects of thermal damage to the stainless steel, known as “blueing”. (see green top size coat in the chart)

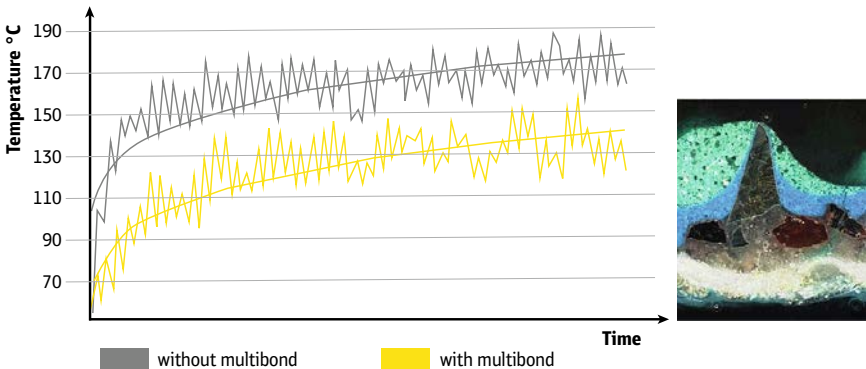

Stearate

A stearate coating prevents premature loading of the abrasive when working on soft materials that become sticky in the sanding process, like paint, lacquer, varnish and plastics (see chart).

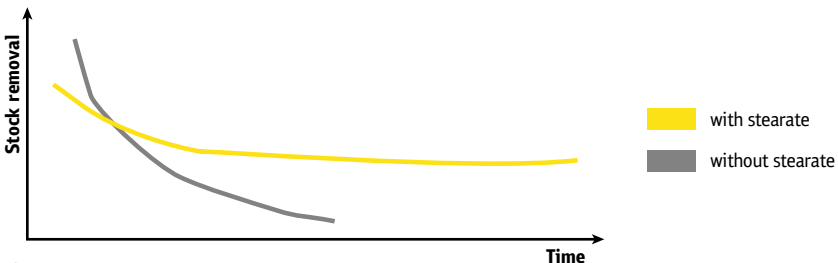

Advanced Coating Technology

For other problems coming up while grinding the Advanced Coating Technology (ACT) has been developed. Advantages for working are:

- ▶ Metal: extremely good adhesion of the grit
- ▶ Wood: less clogging (see picture)



without ACT



with ACT

Long life abrasives

Abrasive belts with **agglomerate** or **noppex** are so-called long life abrasives. A very high lifetime and consistent surface finish without deterioration (see chart).

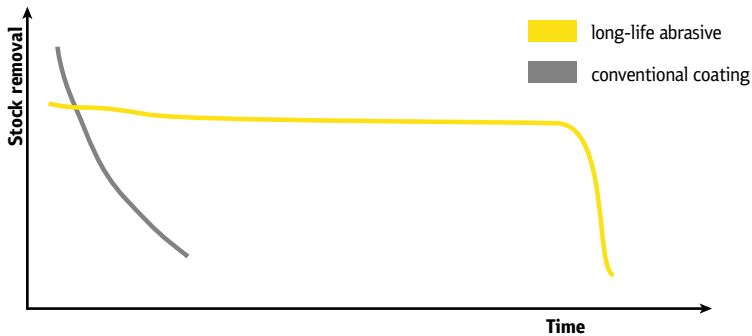

Agglomerate (see left picture), **noppex** and abrasive belts with a mixture of **cork**/grain (see right picture) are suitable for surface refinement.

Some of the above-mentioned products are available with a backing out of polycotton, which is also flexible and tear-resistant.

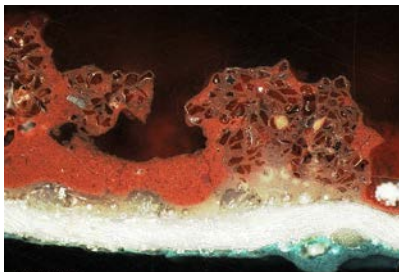

Non-Woven Web

A special product is non-woven web. Because of its structure, it fits to these fields **of application**:

- ▶ Surface refinement
- ▶ Adjustment of the grinding pattern
- ▶ Make a smooth surface
- ▶ Cleaning works
- ▶ Removing of tempering colors
- ▶ Light deburring
- ▶ Roughening
- ▶ Dry and wet applications

By the open structure (see picture) non-woven web resists loading, has a soft, gentle grinding behavior to the surface and a very good flexibility to the contour of the work piece.

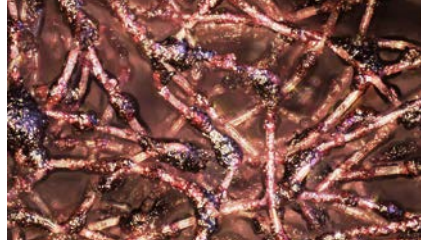

The **Klingspor non-woven web portfolio** includes:

- ▶ Belts
- ▶ Abrasive mop discs
- ▶ Discs
- ▶ Quick Change Discs
- ▶ Rolls
- ▶ Pads
- ▶ Heavy duty discs (unitized)
- ▶ Cleaning wheel
- ▶ Power Wheel
- ▶ Abrasive mop and small abrasive mop



Additionally some products (abrasive mop discs and abrasive mop) are available as a **combi** version. These are made out of flaps of non-woven web and coated abrasive. The **advantages** of these combinations are high stock removal with fine grinding pattern and long lifetime at once.

In application with other Klingspor products nearly all works from cleaning up to finish can be done easily. Exampels are shown in the following charts.

A finer finish with every step:

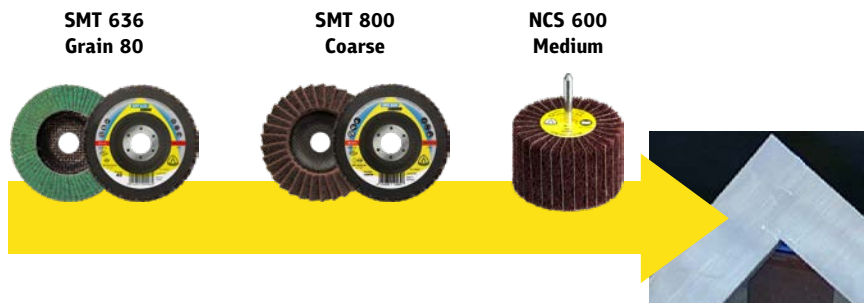
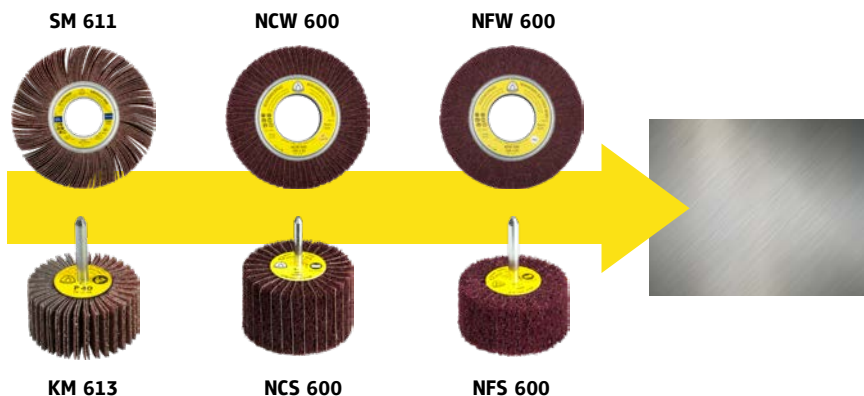

Abrasive Mop Discs

Type of grain

The most popular and most cost effective type of grain used for SMT flap discs is Zirconium. With the self sharpening effect of the abrasive grain and the addition of the wear behaviour of the structure of an abrasive flap on the SMT flap disc, this give a great combination for aggressive long life grinding on steel and stainless steel. For even more aggression, ceramic can also be used for high alloy materials for increased performance.

Wear behavior of the types of grain

Zirconia alumina

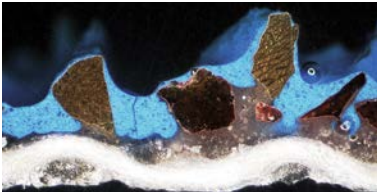
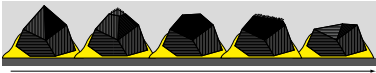

Ceramic aluminium oxide

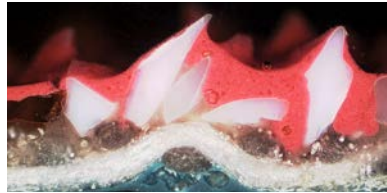
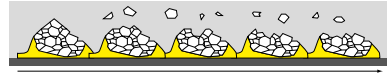

Design

Different designs are for different applications. A flat abrasive mop disc is suitable for grinding surfaces. A convex abrasive mop disc has a smaller contact area, is more aggressive and suitable for grinding e.g. welding lines.

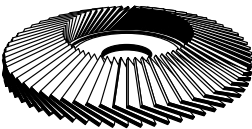

convex



flat



Program of abrasive mop discs

The Klingspor program of abrasive mop discs provides products for each customer need (aggressiveness/lifetime).

With the product-matrix, the right product could be found easily. Reach a high stock removal (aggressiveness) or a high lifetime of the abrasive mop disc.

Line	Steel/ NF-metal	Steel/Stainless steel			Stainless steel	
	Aggressivness			Lifetime	Aggressive- ness	
SPECIAL		SMT 924		SMT 925	SMT 926	SMT 996
SUPRA		SMT 644				
		SMT 624	SMT 628		SMT 626	SMT 636
EXTRA	SMT 314	SMT 324		SMT 325		

Abrasive mop discs with non-woven web

Additional there are special products to suit another field of application: abrasive mop discs with non-woven web or combined, to create a very fine surface.

An example shows the next chart:

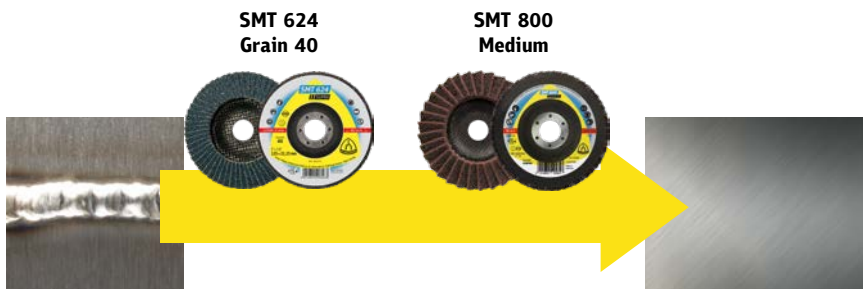

Abrasive Mop

Abrasive mop wheels

Abrasive mop wheels have a fan-shaped composition with radial arranged abrasive flaps. Therefore the products offer divers **characteristics**:

- ▶ Fine surface finish
- ▶ Even surfaces
- ▶ Low roughness
- ▶ Soft comfortable grinding
- ▶ Optimal adaption to the contour of the work piece

The grinding pattern made with an abrasive mop wheel is minimum 2-3 grit sizes finer than that made by a conventional grinding belt, the comparison is shown the following pictures:



Grinding belt grit size 40

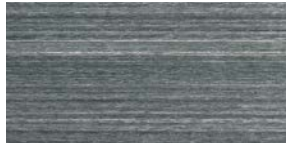

Abrasive mop wheel grit size 40



By changing the **length** of the abrasive flap and/or the **packet assembling** of a mop wheel hardness and flexibility can be influenced.

Metal side-flange

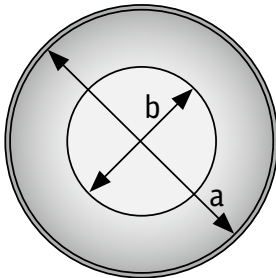

(Products with appropriate clamping could be used without mounting plate SMD 612.)

Mop diameter [mm]	a outer diameter [mm]	b inner diameter [mm]
Standard plate		
100, 125, 130, 140	60	21
150, 165	82	43,1
200, 250	125	68,2
300	158	97,8
350	205	131,8
380, 410	232	151,6
480, 510	332	244,5
Special plate		
165, 200	94	54
250, 300	147	100

The optimal **cutting speed** of mop wheels is 38-42 m/s, but depending to the material, which is grinded, the machine that is used and the tool itself. A safe mounting ist guaranteed by combining the mounting plate SMD 612 with the metal side-flange integrated in the abrasive mop.

Klingspor has a range of mop wheels for many varied applications:

- ▶ Different bore diameters
- ▶ Slashed mop wheels
- ▶ Non-woven web mop wheels
- ▶ Non-woven web/coated abrasive combination mop wheels
- ▶ Angle grinder mop
- ▶ Pleated mop

Small abrasive mop

Small abrasive mops have a fan-shaped composition with radial arranged abrasive flaps and a shaft as well. The products have the same advantages like mop wheels and the suitability for working on:

- ▶ Internal surfaces
- ▶ Areas difficult to access
- ▶ Small part

Best performance and lifetime for small abrasive mops, observe optimal **cutting speed** of 20-25 m/s.



Kronenflex®

Kronenflex® cutting-off wheels

All **high-speed Klingspor products** offer highest **safety standards** and comply with oSa regulations and the European safety standard EN 12413.

Each Kronenflex® product is special developed for its intended use. With variation of the hardness of bonding, type of grain and grit size are the main characteristics to influence the wheels performance for speed and lifetime. The ideal formula is: the harder the material is to be ground, the softer the bonding required for the disc.

The following chart shows the composition of a Kronenflex® cutting-off wheel:

1. Label
2. Mixture
3. Metal ring
4. Glas fibre

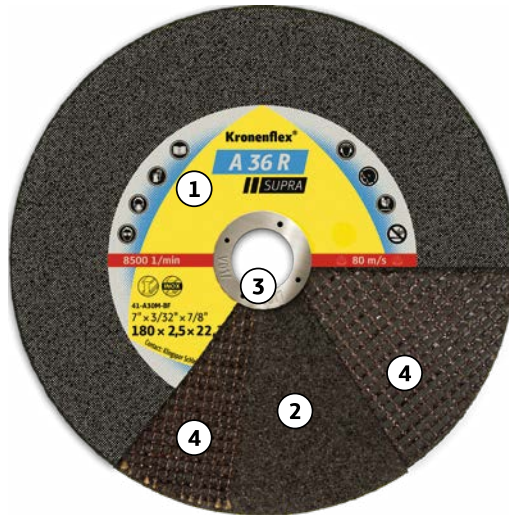

The **applications** are many:

- ▶ Cutting of thin walled materials, on which low heat and minimal burr formation are essential
- ▶ Cutting of heavy sections, when high side load stability is required
- ▶ Cutting of hard materials with large diameter wheels for fast cutting and reduced heat build

Kronenflex® grinding

Kronenflex® grinding discs have a similar structure like cutting-off wheels, but contain minimum one glass fibre more for reinforcement.

Classic **applications** are:

- ▶ Working on surfaces (removing of welds)
- ▶ Grinding of edges
- ▶ Removing of burrs

Choice of the right product

For the choice of the right product the Klingspor **online product finder** can be used (see picture right) or the Klingspor color code system (see below).

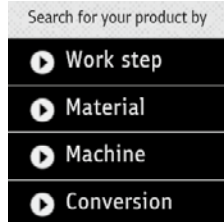

The three product lines



EXTRA



SUPRA



SPECIAL

Colour coding system of Klingspor



Metal universal

Grey



Steel

Black



Stainless steel

Blue



Casting

Red



Stainless steel

Blue



Stone / concrete

Green

Quick Change Discs

The purpose is in the name "quick change discs". Fast changing of the abrasives when working in small difficult to access areas. Allows grinding in areas where larger tools don't fit. To suit a wide range of material types.

Quick change discs are available in following **dimensions**:

ø 25 mm, ø 38 mm, ø 50 mm and ø 76 mm

With three hardness of backing pads:

- ▶ Soft – grinding profiles and finishing
- ▶ Medium – as best all-rounder
- ▶ Firm – for more aggressiveness

In addition, Klingspor offers two **kinds of mounting** (see picture):

- ▶ Quick metal connect (left side)
- ▶ Quick roll connect (right side)











Fields of application:

- ▶ Application on surfaces and edge
- ▶ Cleaning
- ▶ Deburring
- ▶ Finishing

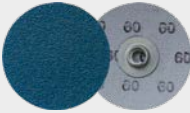
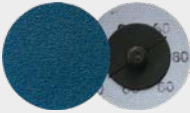
Advantages:

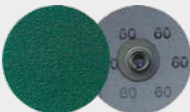
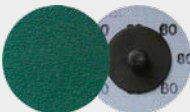
- ▶ Shortened set-up times by quick change of the tool
- ▶ No shifting or lifting by heat, because there is not a bonding by glue or self-fastening
- ▶ The tool is sitting centrally every time
- ▶ Simple handling and smooth running
- ▶ Many possibilities for application by different dimensions and hardness of backing pads

The **Klingspor portfolio** includes a suitable type for each application (see table).

	Product		Application
QRM / QMR 412			Steel, NF-metal
QRM / QMR 411			Steel, stainless steel
QRM / QMR 409			Stainless steel, aluminium
QRM / QMR 910			Stainless steel, high alloyed steel
QRM / QMR 400			Steel, stainless steel
QRM / QMR 800			Paint, lacquer, varnish

Carbide Burrs

Under consideration of highest quality standards and with highest precision carbide burrs from the Klingspor portfolio are made.











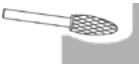

The burrs are developed for many **fields of application:**

- ▶ Foundry
- ▶ Ship building
- ▶ Aircraft construction
- ▶ Metal working general
- ▶ Mold and die
- ▶ Aerospace



Forms

By different forms of the burrs processing of diverse geometries of work pieces is possible. Suitable to the geometry choosing is made:

Type	Form	Type	Form
HF 100 A		HF 100 H	
HF 100 B		HF 100 J	
HF 100 C		HF 100 K	
HF 100 D		HF 100 L	
HF 100 E		HF 100 M	
HF 100 F		HF 100 N	
HF 100 G			

Cuts

After choosing of form and dimension of the burr, the cut is chosen. The different cuts (serrations), are adapted to the different materials and requirements of working. The pictures show the three current cuts:



Cut 2

Steel, casting
Good characteristics for finishing



Cut 3

Aluminium and other NF-metals, plastic
High stock removal, less clogging



Cut 6

Metal
better handling, small chips, less vibration

Furthermore, there are additional cuts (see pictures) especially for steel or stainless steel. Their advantages are higher aggressiveness and easy cutting, better chip removal, clearly longer lifetime, less thermic strain of the tool and the work piece and reducing of tempering colors in INOX.



Cut 10

Steel processing
Optimized serration, higher stock removal



Cut 11

Austenitic, rust- and acid-proofed stainless steels
Optimized serration, higher stock-removing capacity

Klingspor burr sets:

- ▶ 40-piece set with all top sellers in a lockable presentation box
- ▶ 5-piece set with burrs in the most important forms in a screw box, either for metal, steel or stainless steel working



Diamond Tools

With diamond tools out of own development and manufacturing Klingspor offers maximum control over all processes.

All **high-speed Klingspor products** offer highest safety standards and comply with oSa regulations and the European safety standard EN 13236.

1. Klingspor cat. number
2. Product group / type
3. Applications
4. Safety pictograms
5. Max. operating speed
6. Klingspor logo

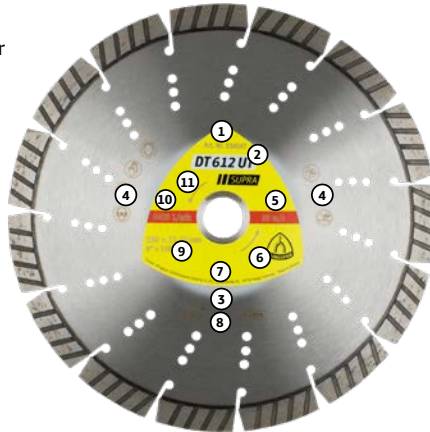

7. Information about the manufacturer
8. Safety standard
9. Dimensions in mm and inches
10. Max. RPM
11. Rotational direction

By influencing the structure the diamond wheel is getting the necessary **characteristics** for the application:

- ▶ Hardness
- ▶ Aggressiveness
- ▶ Lifetime
- ▶ Cutting and running behaviour

Choice of the right tool

For the choice of the right tool differentiation of the **quality classes** (upper part) and the **color-coding system** (bottom) are helpful:

EXTRA

SUPRA

SPECIAL



Asphalt

Black



Tiles

Green



Stone/Fireproof

Blue



Concrete

Red



Universal

White

Besides this, the **type of gullet** is important for a high feed rate, a smooth operation and clean cutting edges.



- 1.**
Standard gullet
- ▶ rapid feed rate
 - ▶ exceptional cutting properties



- 2.**
Turbo continuous rim
- ▶ exceptionally smooth operation
 - ▶ clean cutting edges



- 3.**
Continuous rim
- ▶ clean cutting edges
 - ▶ work with superior precision
 - ▶ short cutting times

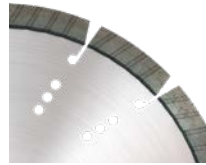

- 4.**
Turbo segments
- ▶ exceptionally smooth operation
 - ▶ clean cutting edges
 - ▶ fast cutting speed
 - ▶ long service life



- 5.**
Short segments
- ▶ first-rate cutting performance
 - ▶ clean cutting edges

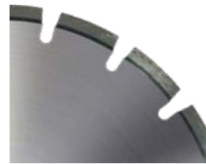

- 6.**
Wide gullet
- ▶ high feed rate

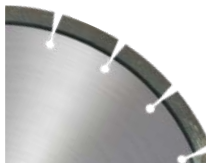

- 7.**
Narrow gullet
- ▶ clean cut
 - ▶ exceptionally smooth operation thanks to narrow segment spacings

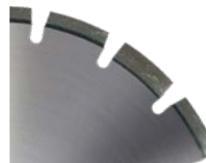

- 8.**
Hammer segments
- ▶ prevent rear grinding
 - ▶ prevent segments tearing off
 - ▶ optimal protection thanks to segments soldered in



- 9.**
Continuous rim with special geometry
- ▶ for extra clean cutting edges
 - ▶ soft and comfortable cutting performance

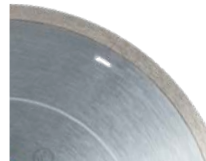

- 10.**
Continuous rim with laser-cut slots
- ▶ for fine and clean cutting edges
 - ▶ specially designed for ceramic and fine stoneware

Flexible Abrasives

A rounding of the **Klingspor program** offer the flexible abrasives:

- ▶ R-Flex wheel
- ▶ R-Flex mounted point
- ▶ Schleiffix mottling point
- ▶ Schleiffix hand block



Characteristics

All these products have similarities in their characteristics. They are soft and adaptable and stay dimensionally stable up to the end of the lifetime. They are used for cleaning and ultra fine finishing and work on nearly all materials.

Applications

The applications are many:

- ▶ Apparatus and container construction
- ▶ Aviation and engine industry
- ▶ Food and chemical industry
- ▶ Large sale catering equipment
- ▶ Surgical instruments and knife industry



The **R-Flex wheel** is deliverable in different types of grain and hardness and suits for deburring as well as for ultra-fine grinding thereby. It can be shaped because of its flexible bonding and can be used optimal for each form of work piece.

For usage on drilling machine and die grinder, the **R-Flex mounted point** is proper. It is available in different dimensions and grit sizes and applicable for cleaning up to finishing.



A special effect on the surface realizes the **R-Flex mottling point**. The Finish is even and reproducible.

The **R-Flex hand block** is available in different grit sizes. The possibilities of application are unlimited: if in industrial or private areas, with additives, for cleaning, polishing or matting.



Wire brushes

The decisive **advantage** of wire brushes is that they work on the surface of a work piece effectively without changing its form. Thereby even the processing of very thin work pieces and sheets is possible.

Application areas and machines

In the **range of Klingspor** suitable wire brushes can be found for different **areas of application**:

- ▶ Cleaning of weld seams and surfaces (derusting, descaling, paint removal)
- ▶ Deburring of cut edges
- ▶ Structuring of surfaces (creating matt, satin or rough finishes)



Wire brushes are available for different **machines**, for angle grinders, drilling machines, flexible shafts and straight grinders and also cordless drills. Furthermore, the Klingspor range contains different ergonomic **formed hand brushes**.

The products are used on a variety of **materials**:

- | | | |
|-----------------|-------------------|----------|
| ▶ Mild steel | ▶ Cast | ▶ Copper |
| ▶ Carbon steel | ▶ Stainless steel | ▶ Brass |
| ▶ Alloyed steel | ▶ Aluminium | ▶ Wood |

Klingspor wire brushes for processing of **stainless steel** are easy to recognize by their green colour.



Characteristics of wire brushes

Klingspor offers various **types** of wire brushes. Through their structure, they are suitable for different application purposes:



Wheel and pipeline brushes

Preparing and finishing weld seams, deburring and cleaning cutting edges, corners or angles



Cup-shaped brushes

For efficient rust, paint or weld spatter removal from large surfaces



Handheld brushes

For the manual cleaning of surfaces and weld seams



Bevel brushes

For work on difficult-to-access areas, corners or edges as well as for surface cleaning



End brushes

deal tool for work on the insides of pipes, drill holes or indentations



Cup-shaped brushes with shaft

Suitable for cleaning small to medium sized surfaces



Wheel brushes with shaft

Perfect tool for cleaning and deburring in hard-to-reach areas, grooves or flutes

Depending on the desired result, different **types** and **versions of wire** are available.



Crimped

- ▶ Gentle, material-friendly brush action
- ▶ For sensitive surfaces and soft materials
- ▶ Perfect contouring to the shape of the workpiece



Knotted

- ▶ Aggressive brush action
- ▶ Long service life
- ▶ Minimum flexibility



Brass wire

Soft, fine brass wire for the surface finish of NF metals (copper, brass)



Polyamide bristle

A flexible abrasive bristle interspersed with SiC abrasive grain. Uniform brush action thanks to the continuous release of new abrasive grain

Notes

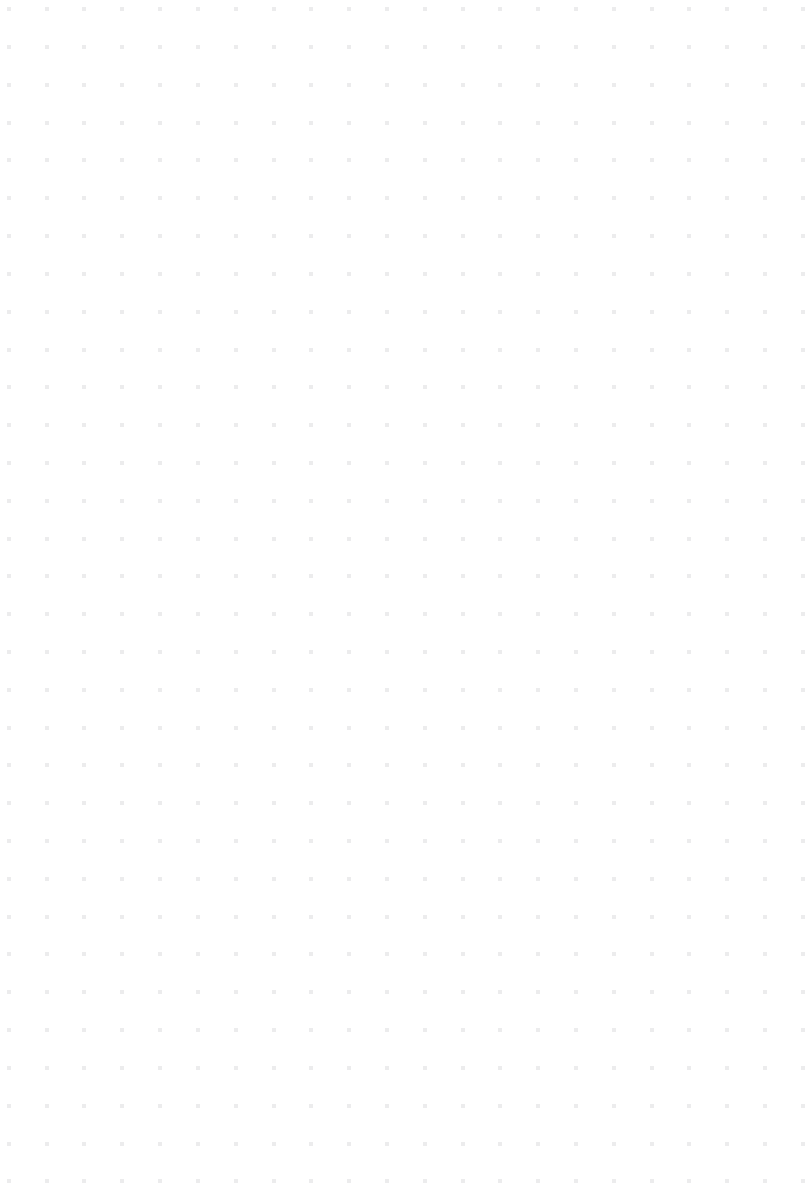



Notes



A large grid of small, light gray dots arranged in a regular pattern, intended for writing notes.

**Klingspor Schleifsysteme
GmbH & Co. KG**

Hüttenstraße 36
35708 Haiger
Germany

Phone +49 (0) 2773 922-0

Fax +49 (0) 2773 922-186

Mail sales@klingspor.de

www.klingspor.de



[/klingsporag](https://www.facebook.com/klingsporag)



[/company/klingsporag](https://www.linkedin.com/company/klingsporag)



[/klingspor_ag](https://www.instagram.com/klingspor_ag)



[/klingspor_ag](https://www.youtube.com/klingspor_ag)

