

Face cutting holder
180° reversible

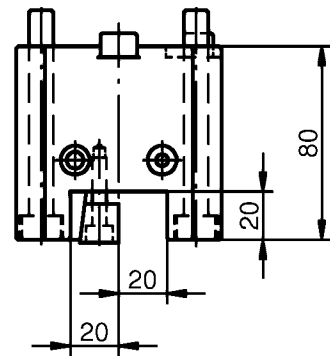
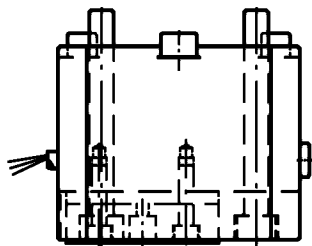
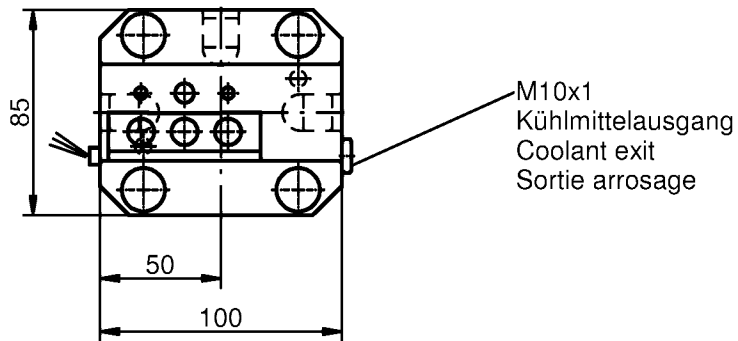
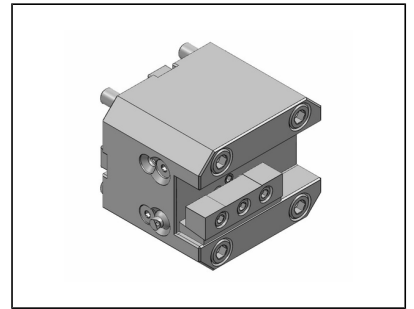

Item No.	Tool Clamping				
48-92045	20				

Accessories
(not included)