

NPA 47

METRIC

VARDEX

Since 1960
VARGUS
NEUMO Ehrenberg Group

VARDEX NPA 47 METRIC | 07/2020 | Page 1/2

External Thread Turning Toolholders WITH TWO HIGH PRESSURE COOLANT OUTLETS

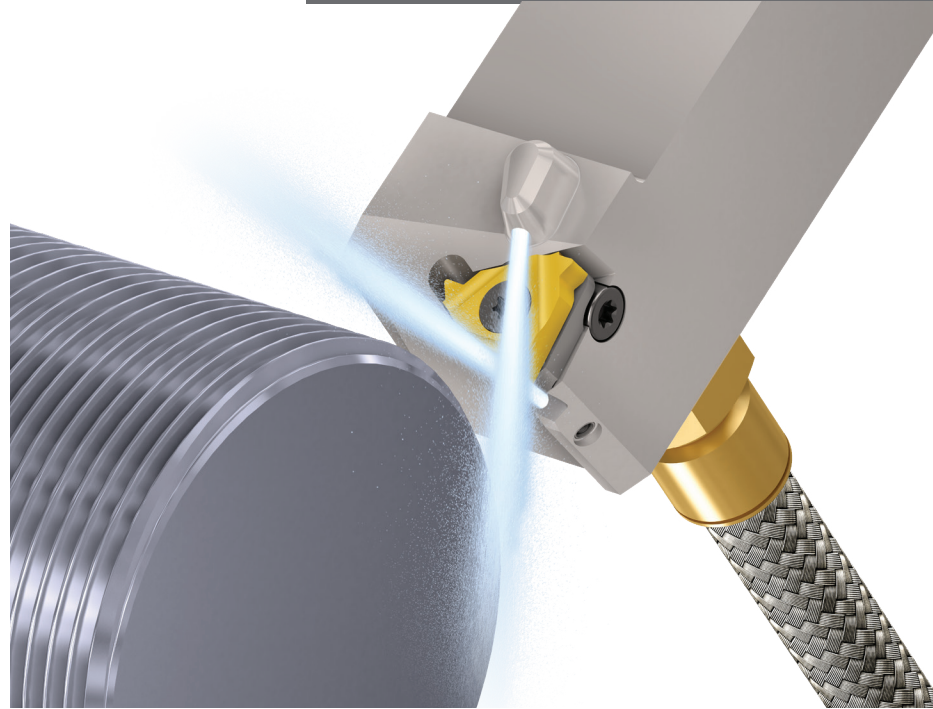

NEW & EXPANDED

Features and Benefits

- Two precise high pressure coolant outlets, designed to cool down the top and bottom of the insert for longer tool life **NEW**
- Up to 70 bar
- Three different coolant inlets available:
 - Bottom inlet, specially designed for **VDI** Holders DIN 10889 **NEW**
 - Back inlet
 - Bottom inlet
- Nickel coating for better wear resistance and anti-corrosion protection
- Greater range of holders for standard insert sizes: 3/8", 1/2", & 5/8" **NEW**
- Available in Metric and Inch shanks
- Left Hand holders are available as standard

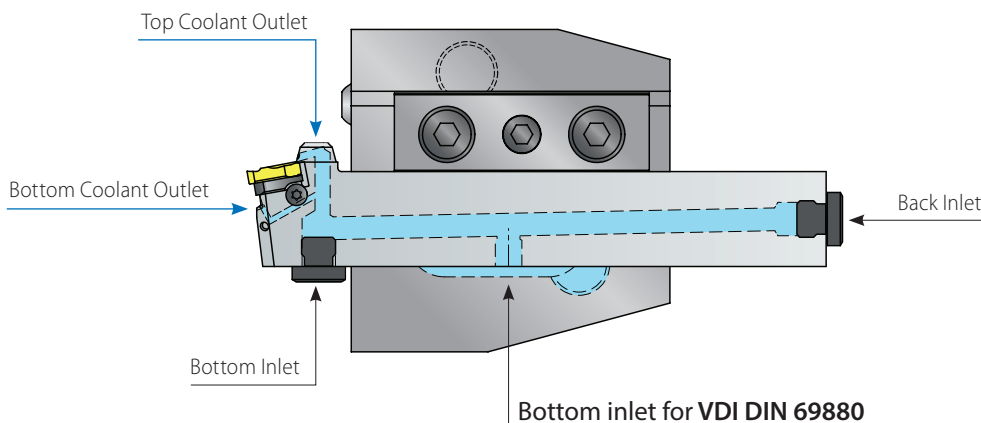

Please contact me directly with specific questions and requests.
For additional updates and news visit the VARGUS website: www.vargus.com

Ami Yacar
Vardex Product Manager

Scroll down for complete details 

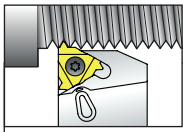

External Toolholders

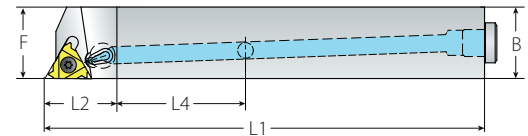
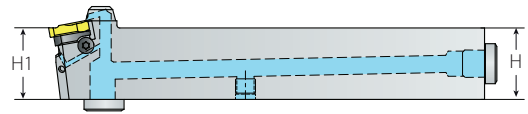

Standard with Coolant - Metric

Insert Size	Ordering Code		Dimensions mm				
IC	RH	LH	H=H1=B	F	L1	L2	L4
3/8"	ALCN16-3	ALCN16-3LH	16	16	100.0	25.1	25
	ALCN20-3	ALCN20-3LH	20	20	127.0		30
	ALCN25-3	ALCN25-3LH	25	25	155.0		35
1/2"	ALCN32-3	ALCN32-3LH	32	32	175.0	30.2	40
	ALCN25-4	ALCN25-4LH	25	25	155.0		35
5/8"	ALCN32-4	ALCN32-4LH	32	32	175.0	35.1	40
	ALCN25-5	ALCN25-5LH	25	25	155.0		35
	ALCN32-5	ALCN32-5LH	32	32	175.0		40

Spare Parts



Insert Screw	Anvil Screw	Torx Key	Anvil RH	Anvil LH	Plug Screw	Socket Screw
SA3T	SY3T	K3T	YE3	YI3	Plug G1/8"	Socket Screw M6x5
SA4T	SY4T	K4T	YE4	YI4		
SA5T	SY5T	K5T	YE5	YI5		

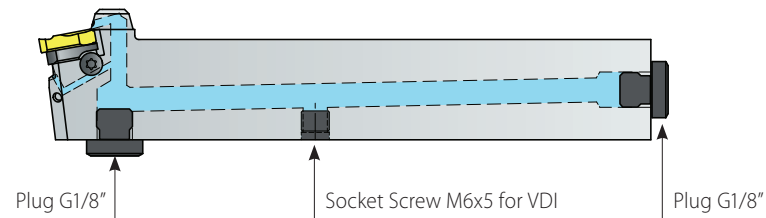

The following HPC accessories (not included) can be ordered separately:

Image	Ordering Code	Item Number	QTY
	Tube Connector 25-6P	013-00941	1
	Angled Fitting G1_8x6P	013-00947	2
	Straight Fitting G1_8x6P	013-00942	

The NEW External Thread Turning Toolholders with HPC are fully supported by **VARGUS GENIUS™**, the most advanced Tool Selector and CNC Program Generator in the metal cutting industry.



New TT External Holders with HPC are now available and can be ordered from stock. Previous TT External Holders with HPC design will remain available to order while supplies last.