

## HSK/KM Tooling System

- B156 Technical Information for HSK / KM Tooling System
- B158 Index for HSK / KM Tooling System
- B159 HSK Tooling System
- B165 KM Tooling System

## Cartridges

- B169 Cartridge Code System (ISO)
- B170 Index for Cartridge
- B171 Clamp On System
- B173 Screw On System

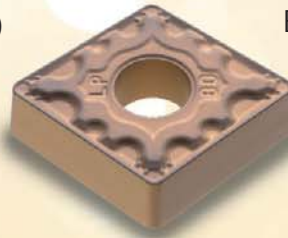

## SAVE TURN

- B175 Technical Information for Save Turn
- B176 Save Turn Insert
- B177 SSave Turn Holder
- B180 Save Turn Boring Bar



## Auto Tools

- B182 Technical Information for Auto Tools
- B183 ISO Type
- B188 Blade Type
- B191 Multi Utility Type
- B194 KGT / MGT Type
- B197 MSB Tool
- B203 Sleeve

# B

# TURING

Korloy turing tools cover a wide application range with a full line-up of ISO tools that produce high quality and high precision parts for all manufacturers requirements.

# B Turning Chip Breakers

## Applications range of chip breakers

### ▶ Negative inserts

**Workpiece P**  
Steel

Heavy	<b>GH</b>		<b>VH</b>		<b>VT</b>	
Roughing			<b>HR</b>			
Medium			<b>MP</b>		<b>VM</b>	
Medium to finishing	<b>VC</b>		<b>LP</b>			
Finishing			<b>VB</b>		<b>VF</b>	

[Recommended]

**Workpiece K**  
Cast iron

Roughing			<b>-MA</b>		<b>VK</b>	
Medium	<b>GR</b>		<b>VR</b>			
Medium to finishing			<b>B25</b>			
Finishing			<b>MP</b>			

[Recommended]

**Workpiece M**  
Stainless steel

Roughing			<b>MP</b>			
Medium			<b>VP3</b>		<b>HS</b>	
Medium to finishing			<b>VP2</b>			
Finishing						

[Recommended]

**Workpiece N**  
Aluminum alloy

Roughing						
Medium						
Medium to finishing			<b>HA</b>			
Finishing						

[Recommended]

**Workpiece S**  
Heat resistant alloy

Roughing			<b>MP</b>			
Medium			<b>VP3</b>			
Medium to finishing			<b>VP2</b>			
Finishing			<b>VP1</b>			

[Recommended]





## Applications range of chip breakers



### ▶ Positive inserts

**Workpiece P**  
Steel

Roughing

Medium **C25** 

Medium to finishing **HMP**  **MP** 

Finishing **VL**  **VF** 

[Recommended]

**Workpiece K**  
Cast iron

Roughing

Medium **C25** 

Medium to finishing **MP** 



Finishing

[Recommended]

**Workpiece M**  
Stainless steel

Roughing

Medium **C25** 

Medium to finishing **HMP**  **MP** 

Finishing **VL** 

[Recommended]

**Workpiece N**  
Aluminum alloy

Roughing

Medium **AR** 

Medium to finishing **AK** 

Finishing



[Recommended]

**Workpiece S**  
Heat resistant alloy

Roughing

Medium

Medium to finishing **MP** 

Finishing **VPI**  **VL** 

[Recommended]



# B Turning Chip Breakers

## Recommended chip breaker for workpiece

Workpiece  
**P**  
Steel

Materials : SM10C, SM15C, SM25C, SS400, SCr415, SCM415, etc. Soft steel

Hardness : under 180HB

Depth of cut (mm)	C/B	Cutting edge	Feed (mm/rev)	Grades	Cutting Speed (m/min)	Insert shape					
						80°	55°	90°	60°	35°	80°
Negative	0.2 ~ 0.8 ~ 1.5 finishing	VL	0.1 ~ 0.2 ~ 0.35	NC3215 NC3225 CN1500 CN2500	305 250 260 230	CNMG p. B20	DNMG p. B27	SNMG p. B35	TNMG p. B43	VNMG p. B49	WNMG p. B51
	0.5 ~ 1.0 ~ 1.5 finishing	VF	0.05 ~ 0.15 ~ 0.35	NC3215 NC3220 NC3225 NC5330	305 270 270 210	CNMG p. B20	DNMG p. B26	SNMG p. B35	TNMG p. B43	VNMG p. B49	WNMG p. B51
	0.5 ~ 1.0 ~ 2.0 finishing	VB	0.15 ~ 0.2 ~ 0.4	NC3215 NC3225 CN1500 CN2500	340 250 240 210	CNMG p. B20	DNMG p. B26		TNMG p. B42		WNMG p. B51
	0.5 ~ 1.5 ~ 3.5 medium to finishing	VC	0.12 ~ 0.25 ~ 0.45	NC3215 NC3220 NC3225 NC5330	285 250 255 200	CNMG p. B21	DNMG p. B28	SNMG p. B36	TNMG p. B44	VNMG p. B49	WNMG p. B52
	0.5 ~ 1.0 ~ 2.5 medium to finishing	LP	0.10 ~ 0.25 ~ 0.40	NC3215 NC3225	300 250	CNMG p. B21	DNMG p. B27	SNMG p. B35	TNMG p. B44	VNMG p. B49	WNMG p. B52
	0.5 ~ 1.5 ~ 4.5 medium to finishing	MP	0.15 ~ 0.30 ~ 0.45	NC3215 NC3225	300 265	CNMG p. B22	DNMG p. B28	SNMG p. B37	TNMG p. B45	VNMG p. B50	WNMG p. B53
	1.0 ~ 2.5 ~ 5.0 medium to finishing	VM	0.10 ~ 0.25 ~ 0.50	NC3215 NC3220 NC3225 NC5330 CN1500 CN2500	295 260 260 205 220 200	CNMG p. B22	DNMG p. B29	SNMG p. B37	TNMG p. B45	VNMG p. B50	WNMG p. B53
	2.5 ~ 4.0 ~ 7.0 roughing	HR	0.25 ~ 0.45 ~ 0.65	NC3215 NC3220 NC3225 NC5330	270 240 240 190	CNMG p. B24	DNMG p. B31	SNMG p. B38	TNMG p. B47		WNMG p. B54
	6.0 ~ 10.0 ~ 15.0 Heavy (General)	VH	0.7 ~ 1.0 ~ 1.4	NC3215 NC3030 NC500H NC5330	50~250 50~150 50~150 50~150	CNMM p. B25		SNMM p. B39			
	7.0 ~ 12.0 ~ 17.0 Heavy (High feed cutting)	VT	0.75 ~ 1.2 ~ 1.6	NC3215 NC3030 NC500H NC5330	50~250 50~150 50~150 50~150	CNMM p. B25		SNMM p. B39			

### P Negative

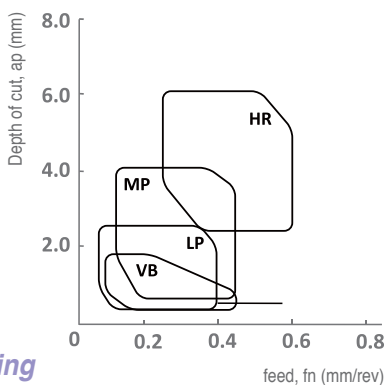

### P Positive

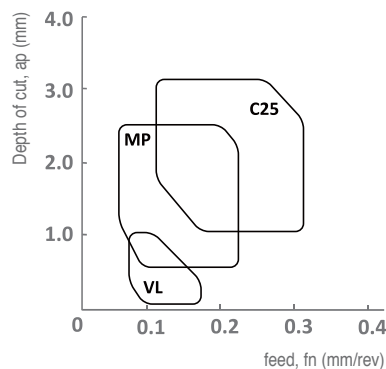





























• The first recommended cutting condition



Workpiece  
**P**  
 Steel

## Recommended chip breaker for workpiece

**Materials :** SM10C, SM15C, SM25C, SS400, SCr415, SCM415, etc. Soft steel  
**Hardness :** under 180HB

Depth of cut (mm)	C/B	Cutting edge	Feed (mm/rev)	Grades	Cutting Speed (m/min)	Insert shape					
						80°	55°	90°	60°	35°	80°
<b>Positive</b>	VL		0.05 ~ <b>0.1</b> ~ 1.0 finishing	NC3215 <b>NC3220</b> <b>NC3225</b> NC5330 CN1500 CN2500	305 <b>270</b> <b>270</b> 210 260 240	CCMT  p. B58	DCMT  p. B62	SCMT  p. B64	TCMT  p. B68	VB(C)MT  p. B74(B76)	
	VF		0.05 ~ <b>0.15</b> ~ 1.5 finishing	NC3215 NC3220 <b>NC3225</b> NC5330 CC1500 CN1500 CN2500	305 270 <b>270</b> 210 260 250 230	CCMT  p. B57	DCMT  p. B62	SCMT  p. B64	TC(P)MT  p. B68(B72)	VB(C)MT  p. B74(B76)	
	MP		0.1 ~ <b>0.2</b> ~ 3.0 medium to finishing	NC3215 <b>NC3225</b> CN1500 CN2500	300 <b>250</b> 240 200	CCMT  p. B58	DCMT  p. B62	SCMT  p. B64	TC(P)MT  p. B68(B72)	VB(C)MT  p. B73(B76)	
	HMP		0.08 ~ <b>0.20</b> ~ 0.40	NC3215 NC3220 <b>NC3225</b> NC5330 CN1500 CN2500	320 285 <b>285</b> 225 240 220	CCMT  p. B58	DCMT  p. B62	SCMT  p. B64	TCMT  p. B68	VB(C)MT  p. B73(B76)	
	C25		0.10 ~ <b>0.25</b> ~ 0.35	NC3215 NC3220 <b>NC3225</b> NC5330 CN1500 CN2500	320 285 <b>285</b> 225 230 210	CCMT  p. B58	DCMT  p. B62	SCMT  p. B64	TCMT  p. B69		

•: The first recommended cutting condition



# B Turning Chip Breakers

## Recommended chip breaker for workpiece

Workpiece  
**P**  
Steel

Materials : S45C, S55C, SCM430, SCM440, etc. General steel

Hardness : under 180~260HB

Depth of cut (mm)	C/B	Cutting edge	Feed (mm/rev)	Grades	Cutting Speed (m/min)	Insert shape					
						80°	55°	90°	60°	35°	80°
Negative	0.5 ~ 1.0 ~ 1.5 finishing	VF	0.05 ~ 0.15 ~ 0.35	NC3215 NC3225 NC5330	305 270 250	CNMG p. B20	DNMG p. B26	SNMG p. B35	TNMG p. B43	VNMG p. B49	WNMG p. B51
	0.5 ~ 1.0 ~ 2.0 finishing	VB	0.15 ~ 0.2 ~ 0.4	NC3215 NC3225 CN1500 CN2500	340 250 230 190	CNMG p. B20	DNMG p. B26		TNMG p. B42		WNMG p. B51
	0.5 ~ 1.0 ~ 2.5 medium	LP	0.10 ~ 0.25 ~ 0.40	NC3215 NC3225	300 250	CNMG p. B21	DNMG p. B27	SNMG p. B35	TNMG p. B44	VNMG p. B47	WNMG p. B52
	0.5 ~ 1.5 ~ 4.5 medium	MP	0.15 ~ 0.30 ~ 0.45	NC3215 NC3225	300 250	CNMG p. B22	DNMG p. B28	SNMG p. B37	TNMG p. B45	VNMG p. B50	WNMG p. B53
	0.5 ~ 1.5 ~ 3.5 Medium to finishing	VC	0.12 ~ 0.25 ~ 0.45	NC3215 NC3220 NC3225 NC5330	285 255 250 200	CNMG p. B21	DNMG p. B28	SNMG p. B36	TNMG p. B44	VNMG p. B49	WNMG p. B52
	1.0 ~ 2.5 ~ 5.0 medium	VM	0.10 ~ 0.25 ~ 0.50	NC3215 NC3220 NC3225 NC5330 CN1500 CN2500	260 245 245 205 210 170	CNMG p. B22	DNMG p. B29	SNMG p. B37	TNMG p. B45	VNMG p. B50	WNMG p. B53
	2.5 ~ 4.0 ~ 7.0 Roughing	HR	0.25 ~ 0.45 ~ 0.65	NC3215 NC3220 NC3225 NC5330	270 240 240 190	CNMG p. B24	DNMG p. B31	SNMG p. B38	TNMG p. B47		WNMG p. B54
	6.0 ~ 10.0 ~ 15.0 Heavy (General)	VH	0.7 ~ 1.0 ~ 1.4	NC3215 NC3030 NC500H NC5330	50~250 50~150 50~150 50~150	CNMM p. B25		SNMM p. B39			
7.0 ~ 12.0 ~ 17.0 Heavy (High feed cutting)	VT	0.75 ~ 1.2 ~ 1.6	NC3215 NC3030 NC500H NC5330	50~250 50~150 50~150 50~150	CNMM p. B25		SNMM p. B39				
Positive	0.1 ~ 0.5 ~ 1.0 finishing	VL	0.05 ~ 0.1 ~ 0.2	NC3215 NC3220 NC3225 NC5330 CN1500 CN2500	345 310 310 240 250 210	CCMT p. B58	DCMT p. B62	SCMT p. B64	TCMT p. B61	VB(C)MT p. B74(76)	
	0.1 ~ 0.5 ~ 1.5 finishing	VF	0.05 ~ 0.15 ~ 0.25	NC3215 NC3220 NC3225 NC5330 CC1500 CN1500 CN2500	285 300 300 230 260 240 210	CCMT p. B57	DCMT p. B62	SCMT p. B64	TC(P)MT p. B68(B72)	VCMT p. B74(B76)	
	0.30 ~ 1.5 ~ 3.0 Medium to finishing	MP	0.05 ~ 0.15 ~ 0.35	NC3215 NC3225	300 250	CCMT p. B58	DCMT p. B62	SCMT p. B64	TC(P)MT p. B68(B72)	VB(C)MT p. B73(B76)	
	1.0 ~ 2.0 ~ 3.0 medium	C25	0.1 ~ 0.15 ~ 0.35	NC3215 NC3220 NC3225 NC5330 CN1500 CN2500	320 285 285 225 230 200	CCMT p. B58	DCMT p. B62	SCMT p. B64	TCMT p. B69		

• The first recommended cutting condition



Workpiece  
**P**  
Steel

## Recommended chip breaker for workpiece

Materials : SNC415, SNC815, SNCM240, SNCM439, STS12, STS61, etc  
SCM440, Hardened steel  
Hardness : 260~350HB

Depth of cut (mm)	C/B	Cutting edge	Feed (mm/rev)	Grades	Cutting Speed (m/min)	Insert shape					
						80°	55°	90°	60°	35°	80°
Negative	0.5 ~ 1.0 ~ 1.5 finishing	VF	0.08 ~ 0.15 ~ 0.30	NC3215 NC3220 NC3225	180 159 159	CNMG p. B20	DNMG p. B26	SNMG p. B35	TNMG p. B43	VNMG p. B49	WNMG p. B51
	0.5 ~ 1.0 ~ 2.0 finishing	VB	0.15 ~ 0.2 ~ 0.4	NC3215 CN1500 CN2500	200 220 200	CNMG p. B20	DNMG p. B26		TNMG p. B42		WNMG p. B51
	0.5 ~ 1.5 ~ 3.5 Medium to finishing	VC	0.12 ~ 0.25 ~ 0.45	NC3215 NC3220 NC3225 NC5330	168 148 150 200	CNMG p. B21	DNMG p. B28	SNMG p. B36	TNMG p. B44	VNMG p. B49	WNMG p. B52
	0.5 ~ 1.0 ~ 2.5 medium	LP	0.10 ~ 0.25 ~ 0.40	NC3215 NC3225	250 200	CNMG p. B21	DNMG p. B27	SNMG p. B35	TNMG p. B44	VNMG p. B49	WNMG p. B52
	0.5 ~ 1.5 ~ 4.5 medium	MP	0.15 ~ 0.30 ~ 0.45	NC3215 NC3225	250 200	CNMG p. B22	DNMG p. B28	SNMG p. B37	TNMG p. B45	VNMG p. B50	WNMG p. B52
	1.0 ~ 2.5 ~ 5.0 medium	VM	0.15 ~ 0.25 ~ 0.50	NC3215 NC3220 NC3225 CN1500 CN2500	174 153 153 120 100	CNMG p. B22	DNMG p. B29	SNMG p. B37	TNMG p. B45	VNMG p. B50	WNMG p. B53
	2.5 ~ 4.0 ~ 7.0 Roughing	HR	0.25 ~ 0.35 ~ 0.60	NC3215 NC3220 NC3225 NC5330	159 142 142 112	CNMG p. B24	DNMG p. B31	SNMG p. B38	TNMG p. B47		WNMG p. B54
	6.0 ~ 10.0 ~ 15.0 Heavy (General)	VH	0.7 ~ 1.0 ~ 1.4	NC3215 NC3030 NC500H NC5330	50~250 50~150 50~150 50~150	CNMM p. B25		SNMM p. B39			
	7.0 ~ 12.0 ~ 17.0 Heavy (High feed cutting)	VT	0.75 ~ 1.2 ~ 1.6	NC3215 NC3030 NC500H NC5330	50~250 50~150 50~150 50~150	CNMM p. B25		SNMM p. B39			
Positive	0.1 ~ 0.5 ~ 1.0 finishing	VL	0.05 ~ 0.1 ~ 0.2	NC3215 NC3220 NC3225 NC5330 CN1500 CN2500	305 310 310 240 210 190	CCMT p. B58	DCMT p. B62	SCMT p. B63	TCMT p. B68	VB(C)MT p. B74(B76)	
	0.1 ~ 0.5 ~ 1.5 finishing	VF	0.05 ~ 0.15 ~ 0.25	NC3215 NC3220 NC3225 NC5330 CC1500 CN1500 CN2500	330 300 300 230 260 250 240	CCMT p. B57	DCMT p. B62	SCMT p. B64	TC(P)MT p. B68(B72)	VB(C)MT p. B74(B76)	
	0.30 ~ 1.5 ~ 3.0 Medium to finishing	MP	0.05 ~ 0.15 ~ 0.35	NC3215 NC3225 NC5300 CN1500 CN2500	305 285 225 240 220	CCMT p. B58	DCMT p. B62	SCMT p. B64	TC(P)MT p. B68(B72)	VB(C)MT p. B73(B76)	
	1.0 ~ 2.0 ~ 3.0 medium	C25	0.1 ~ 0.15 ~ 0.35	NC3215 NC3220 NC3225 NC5330 CN1500 CN2500	320 285 285 225 100 80	CCMT p. B58	DCMT p. B62	SCMT p. B64	TCMT p. B69		

•: The first recommended cutting condition

# B Turning Chip Breakers

## Recommended chip breaker for workpiece

Workpiece  
**M**  
Stainless steel

Materials : STS304, STS316, STS430, STS630  
Ferrite, austenite, martensite, precipitation hardening stainless steels  
Hardness : 135~300HB

Depth of cut (mm)	C/B	Cutting edge	Feed (mm/rev)	Grades	Cutting Speed (m/min)	Insert shape					
						80°	55°	90°	60°	35°	80°
Negative	0.5 ~ 1.5 ~ 4.0 Medium to finishing	VP2	0.10 ~ 0.20 ~ 0.40	PC8105 PC8110 PC8115 PC5300 PC5400	185 170 160 135 120	CNMG p. B22	DNMG p. B29	SNMG p. B36	TNMG p. B45		WNMG p. B52
	1.0 ~ 2.0 ~ 4.5 medium	VP3	0.15 ~ 0.23 ~ 0.45	PC8105 PC8110 PC8115 PC5300 PC5400	175 160 150 130 110	CNMG p. B22	DNMG p. B28	SNMG p. B37	TNMG p. B45	VNMG p. B50	WNMG p. B53
	1.0 ~ 2.5 ~ 4.0 medium	HS	0.10 ~ 0.20 ~ 0.40	PC8110 PC9030	160 135	CNMG p. B21	DNMG p. B30	SNMG p. B36	TNMG p. B44	VNMG p. B50	WNMG p. B52
	0.5 ~ 1.5 ~ 4.5 Roughing	MP	0.15 ~ 0.30 ~ 0.45	PC8105 PC8110 PC8115 PC5300	195 160 150 130	CNMG p. B22	DNMG p. B29	SNMG p. B37	TNMG p. B45	VNMG p. B50	WNMG p. B53
Positive	0.1 ~ 0.5 ~ 1.0 finishing	VL	0.05 ~ 0.1 ~ 0.2	PC8105 PC8110 PC8115 PC5300 PC5400 NC5330 NC9025	215 195 190 165 135 165 165	CCMT p. B57	DCMT p. B62	SCMT p. B64	TCMT p. B68	VB(C)MT p. B73(B76)	
	0.30 ~ 1.5 ~ 3.0 Medium to finishing	MP	0.05 ~ 0.15 ~ 0.35	PC8105 PC8110 PC8115 PC5300 PC5400 NC5330 NC9025	190 175 170 135 120 150 150	CCMT p. B58	DCMT p. B62	SCMT p. B64	TC(P)MT p. B68(B72)	VB(C)MT p. B73(B76)	
	1.0 ~ 1.5 ~ 3.0 medium	C25	0.08 ~ 0.13 ~ 0.25	PC8110 PC9030	170 155	CCMT p. B58	DCMT p. B62	SCMT p. B64	TCMT p. B69		

• The first recommended cutting condition

### M Negative

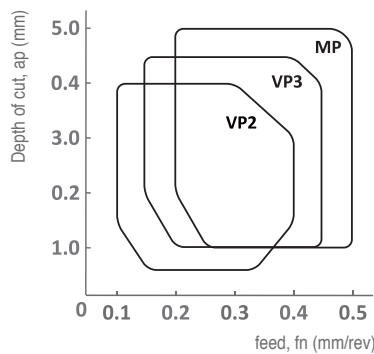

### M Positive

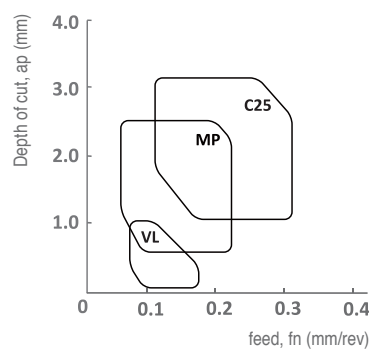























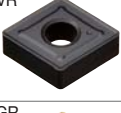



















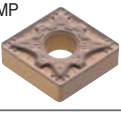













Workpiece  
**K**  
Cast iron

## Recommended chip breaker for workpiece

Materials : GC250, GC300, GCD400, GCD700, etc : Gray cast iron, Ductile cast iron  
Hardness : 135 ~185HB  
Tensile strength : 450N/mm<sup>2</sup>

Depth of cut (mm)	C/B	Cutting edge	Feed (mm/rev)	Grades	Cutting Speed (m/min)	Insert shape					
						80°	55°	90°	60°	35°	80°
<b>Negative</b>	1.0 ~ 2.5 ~ 6.0 Roughing	C/B no 		0.15 ~ 0.30 ~ 0.60	DBNX10 150~200 DBN500 200~500 DBN700 500~2000 NC6205 170~420 NC6210 140~350 NC6215 120~290	CNMA  p. B20	DNMA  p. B26	SNMA  p. B34	TNMA  p. B42		
	1.0 ~ 2.5 ~ 5.0 Roughing	VK 		0.15 ~ 0.25 ~ 0.60	NC6205 450~550 NC6210 350~450 NC6215 200~250	CNMG  p. B23	DNMG  p. B30	SNMG  p. B38	TNMG  p. B47	VNMG  p. B50	WNMG  p. B54
	1.0 ~ 3.0 ~ 4.5 Roughing	VR 		0.2 ~ 0.35 ~ 0.60	NC6215 200~250	CNMG  p. B24	DNMG  p. B31	SNMG  p. B38	TNMG  p. B47		WNMG  p. B54
	1.0 ~ 3.0 ~ 4.5 medium to roughing	GR 		0.20 ~ 0.35 ~ 0.50	NC6205 180~370 NC6210 150~330 NC6215 130~280	CNMG  p. B23	DNMG  p. B30	SNMG  p. B38	TNMG  p. B46		WNMG  p. B54
	0.5 ~ 2.0 ~ 3.5 Medium to finishing	B25 		0.2 ~ 0.35 ~ 0.60	NC6205 170~380 NC6210 140~320 NC6215 120~290	CNMG  p. B23	DNMG  p. B30	SNMG  p. B37	TNMG  p. B46		
	0.5 ~ 1.0 ~ 2.5 finishing	MP 		0.10 ~ 0.25 ~ 0.40	NC6215 200~250	CNMG  p. B22	DNMG  p. B22	SNMG  p. B37	TNMG  p. B45	VNMG  p. B50	WNMG  p. B53
<b>Positive</b>	0.30 ~ 1.5 ~ 3.0 Medium to finishing	MP 		0.1 ~ 0.2 ~ 0.35	NC6215 200-250	CCMT  p. B58	DCMT  p. B62	SCMT  p. B64	TC(P)MT  p. B68	VB(C)MT  p. B74(B76)	
	1.0 ~ 2.0 ~ 3.5 medium	C25 		0.10 ~ 0.25 ~ 0.40	NC6205 340 NC6210 285 NC6215 200	CCMT  p. B58	DCMT  p. B62	SCMT  p. B64	TCMT  p. B69		

•: The first recommended cutting condition

### **K** Negative

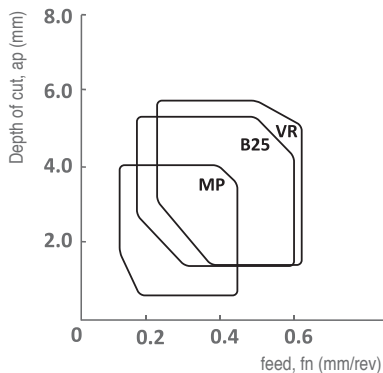

### **K** Positive

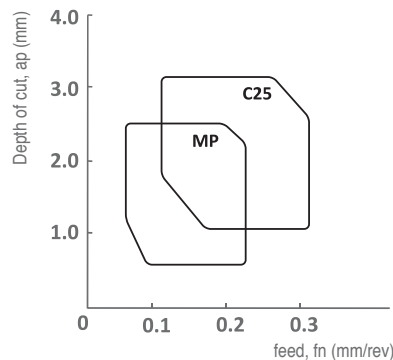

# B Turning Chip Breakers

## Recommended chip breaker for workpiece

Workpiece  
**N**  
Aluminum alloy

Materials : Aluminum alloy

Hardness : 20~110HB

	Depth of cut (mm)	C/B	Cutting edge	Feed (mm/rev)	Grades	Cutting Speed (m/min)	Insert shape					
							80°	55°	90°	60°	35°	80°
Negative	0.5 ~ 2.0 ~ 6.0 medium	HA		0.1 ~ 0.2 ~ 0.5	H01	500	CNMG p. B21	DNMG p. B27	SNMG p. B35	TNMG p. B43	VNMG p. B49	WNMG p. B51
Positive	0.1 ~ 1.0 ~ 4.0 Medium to finishing	AK		0.03 ~ 0.2 ~ 0.4	H01 ND1000 PD1000	1000	CCGT p. B80	DCGT p. B81	SCGT p. B83	TCGT p. B84	VB(C)GT p. B85(B86)	RCGT p. B82
	0.5 ~ 1.5 ~ 4.0 medium	AR		0.05 ~ 0.3 ~ 0.5	H01 ND1000 PD1000	1000	CCGT p. B80	DCGT p. B81	SCGT p. B83	TCGT p. B84	VB(C)GT p. B85(B86)	RCGT p. B82

Materials : Copper Bronze alloy

Hardness : 20~110HB

	Depth of cut (mm)	C/B	Cutting edge	Feed (mm/rev)	Grades	Cutting Speed (m/min)	Insert shape					
							80°	55°	90°	60°	35°	80°
Negative	0.5 ~ 2.0 ~ 4.0 Medium to finishing	HA		0.1 ~ 0.2 ~ 0.5	H01	1000	CNMG p. B21	DNMG p. B27	SNMG p. B35	TNMG p. B43	VNMG p. B49	WNMG p. B51
Positive	0.1 ~ 1.0 ~ 3.0 Medium to finishing	AK		0.03 ~ 0.2 ~ 0.3	H01	1000	CCGT p. B80	DCGT p. B81	SCGT p. B83	TCGT p. B84	VB(C)GT p. B85(B86)	RCGT p. B82
	0.5 ~ 1.5 ~ 3.0 medium	AR		0.05 ~ 0.25 ~ 0.4	H01	1000	CCGT p. B80	DCGT p. B81	SCGT p. B83	TCGT p. B84	VB(C)GT p. B85(B87)	RCGT p. B82

● : The first recommended cutting condition

### N Negative

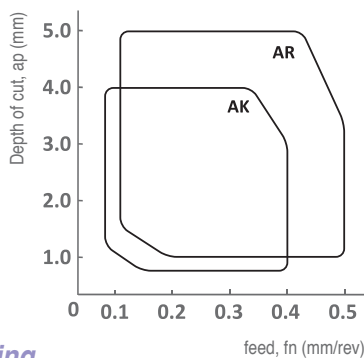

### N Positive

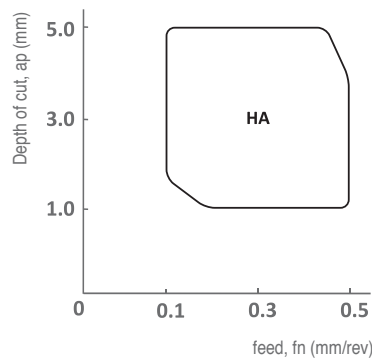

Workpiece  
**S**  
Heat resistant alloy

## Recommended chip breaker for workpiece

Materials : Inconel, Nimonic, Stellite, Ti alloy

Hardness : 160~350HB

Depth of cut (mm)	C/B	Cutting edge	Feed (mm/rev)	Grades	Cutting Speed (m/min)	Insert shape						
						80°	55°	90°	60°	35°	80°	
<b>Negative</b>	0.1 ~ 0.5 ~ 1.5 finishing	VP1	0.05 ~ 0.10 ~ 0.20	PC8110 PC5300 NC5330	60 50 50	CNGG p. B20	DNGG p. B26					
	0.5 ~ 1.5 ~ 4.0 Medium to finishing	VP2	0.10 ~ 0.20 ~ 0.40	PC8110 PC5300	60 45	CNMG p. B21	DNMG p. B28	SNMG p. B36	TNMG p. B44		WNMG p. B52	
	1.0 ~ 2.0 ~ 4.5 medium	VP3	0.15 ~ 0.23 ~ 0.45	PC8110 PC5300	60 40	CNMG p. B22	DNMG p. B29	SNMG p. B37	TNMG p. B45	VNMG p. B50	WNMG p. B53	
	1.5 ~ 2.0 ~ 4.5 Roughing	MP	0.15 ~ 0.3 ~ 0.45	PC8110 PC8115	60 50	CNMG p. B22	DNMG p. B28	SNMG p. B37	TNMG p. B45	VNMG p. B50	WNMG p. B53	
	1.5 ~ 3.0 ~ 5.5 Roughing	GS	0.10 ~ 0.25 ~ 0.50	PC8110 PC5300	50 40	CNMG p. B23	DNMG p. B30	SNMG p. B37	TNMG p. B46		WNMG p. B53	
<b>Positive</b>	0.1 ~ 0.5 ~ 1.5 finishing	VP1	0.05 ~ 0.10 ~ 0.20	PC8110 PC5300	60 45	CCGT p. B57	DCGT p. B61			VCGT p. B75		
	0.1 ~ 0.5 ~ 1.0 finishing	VL	0.05 ~ 0.1 ~ 0.2	PC8110 PC8115	60 50	CCMT p. B58	DCMT p. B62	SCMT p. B64	TCMT p. B68	VCMT p. B74(B76)		
	0.5 ~ 1.0 ~ 3.0 medium	MP	0.1 ~ 0.2 ~ 0.35	PC8110 PC8115	60 50	CCMT p. B58	DCMT p. B62	SCMT p. B64	TC(P)MT p. B68	VB(C)MT p. B74(B76)		

●: The first recommended cutting condition

### **S** Negative

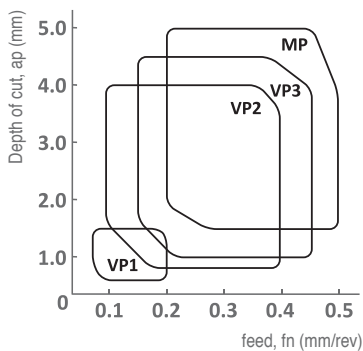

### **S** Positive

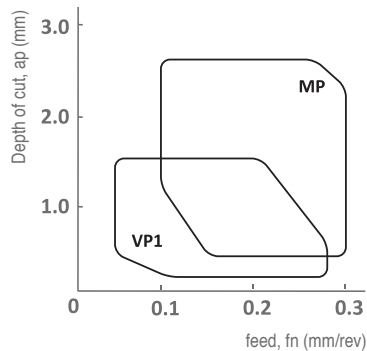

## New Chip Breakers

### LP Chip Breaker [For medium cutting to finishing]

- Chip breaker for forged steel of automobile parts and normal steel.
- Quad dots improve productivity through efficient chip control at high feed.
- Angle land minimizes cutting force.

#### ▶ Features of LP chip breaker

##### ▶ Front dot

- Higher stability of chip curls at high feed
- Excellent chip control when copying
- Lower cutting force at low depth of cut and high feed

##### ▶ Variable land

- Less crater wear
- Prevents chipping on minor cutting edge

##### ▶ Flat zone

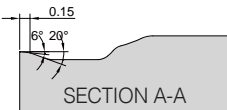

- Larger chip pocket for better chip evacuation at high feed
- Reduced cutting force with larger contact surface of chips

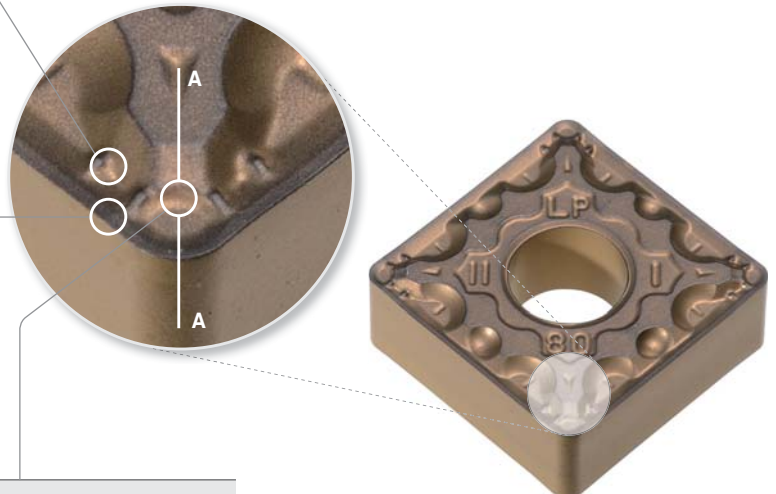

#### ▶ Application Range (Medium to finish cutting)

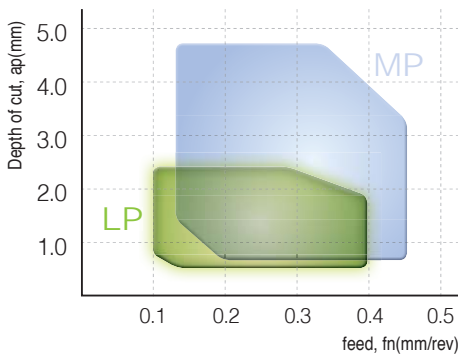

#### ▶ Cutting performance

Medium feed (0.25mm/rev)

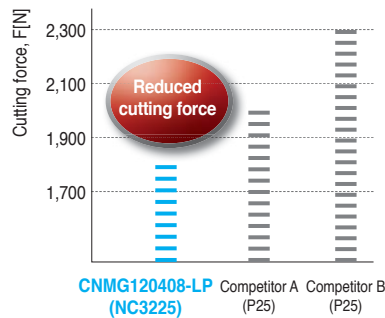

High feed (0.40mm/rev)

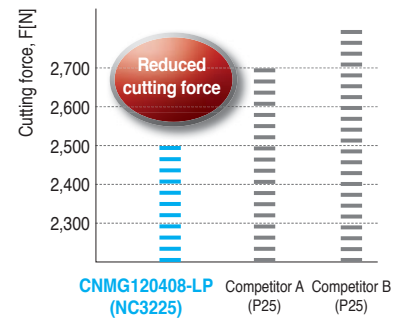



## New Chip Breakers

# MP Chip Breaker [For medium cutting]

- Chip breaker for forged steel of automobile parts and all other steels.
- Quad dots improve productivity through efficient chip control at high feed.
- Angle land minimizes cutting force.

### Features of MP Chip Breaker

#### ▶ Front two step dot

- Higher stability of chip curls at high feed
- Excellent chip control when copying
- Lower cutting force at high depth of cut

#### ▶ Variable land

- Less crater wear
- Prevents chipping on minor cutting edge
- Higher toughness at high depth of cut and interrupted cutting

#### ▶ Flat zone

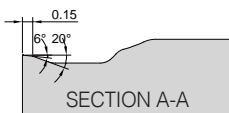

- Larger chip pocket for better chip evacuation at high feed
- Reduced cutting force with larger contact surface of chips

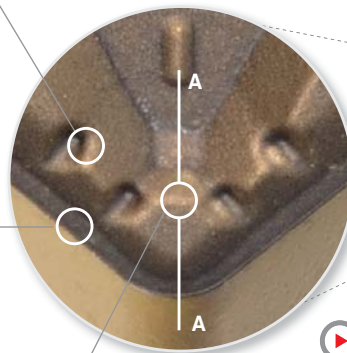
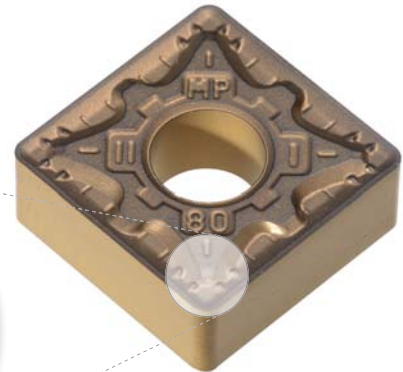

### Application Range (Medium to finish cutting)

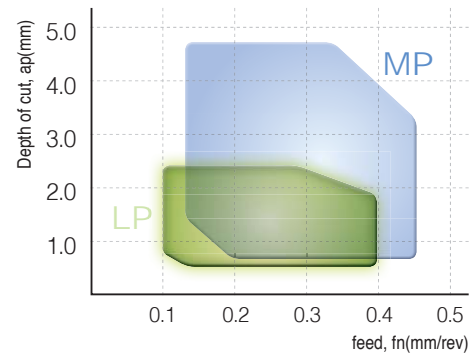

### Wear resistance test

- **Workpiece** SCM440 (Alloy steel)  
Ø100  
Outer diameter machining
- **Cutting conditions** vc(m/min) = 280  
ap(mm) = 1.5  
fn(mm/rev) = 0.25 / 0.40  
wet
- **Tool** CNMG120408-MP

#### Medium feed (0.25mm/rev)

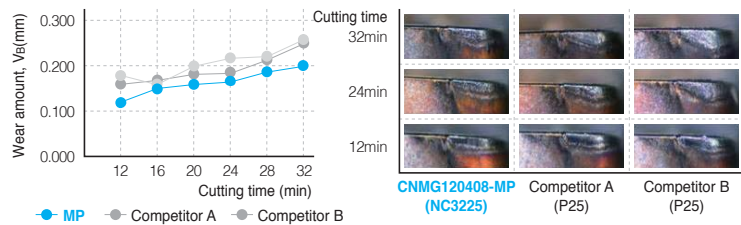

#### High feed (0.40mm/rev)

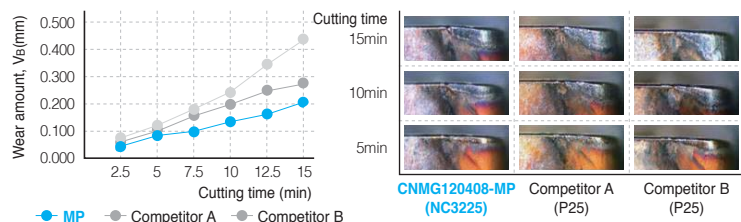

## New Chip Breakers

### VR Chip Breaker [For roughing]

- Increased stability when machining gray cast iron and ductile cast iron
- Increased productivity at high speed and high feed

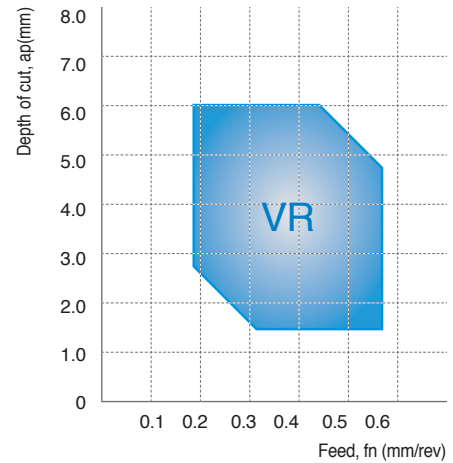

#### ▶ Features of VR chip breaker

- ▶ Wide land and pocket improve cutting performance at high feed
- ▶ Optimal cutting edge design for unstable and interrupted machining

#### ▶ Performance

- Severe wear in continuous/interrupted machining of cast iron  
→ Longer tool life due to new VR chip breaker which is specially designed for high feed machining

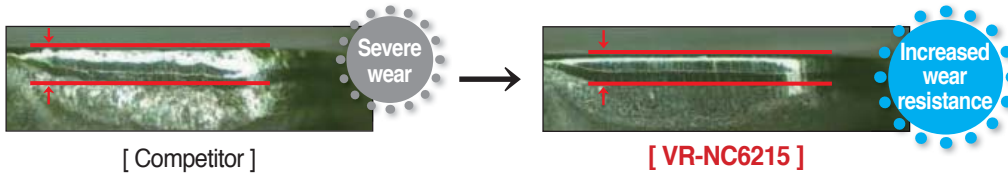

### MP Chip Breaker [For medium machining]

- For continuous cutting of forged steel at high feed
- Turning insert for internal machining of automobile components

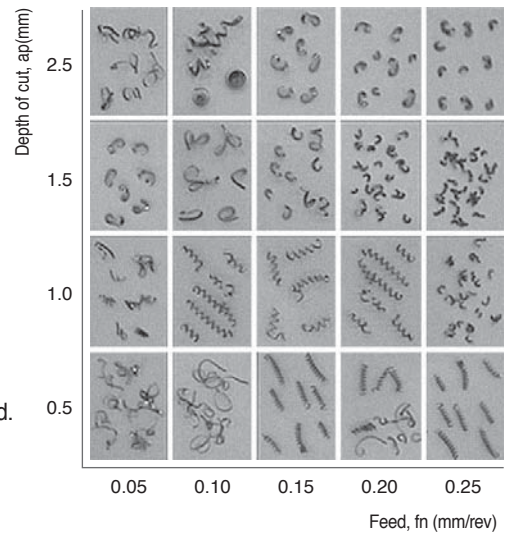
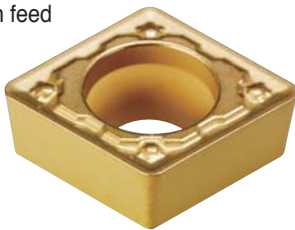

#### ▶ Features of VR chip breaker

- ▶ Three-dimensional 2 step chip breaker
  - Stable chip control in unstable internal machining
  - Prevents chip blocking at internal diameter at varying depth of cut and feed.
- ▶ Stronger cutting edge and wide chip pocket
  - Increased chipping resistance in unstable internal machining

#### ▶ Cutting performance

- **Workpiece** SCM440
- **Cutting conditions**  $vc=200\text{m/min}$ ,  $ap=0.5\sim 2.5\text{mm}$   
 $fn=0.05\sim 0.25\text{mm/rev}$
- **Tool** CCMT09T304-MP



## New Chip Breakers

### VH / VT Chip Breaker [Heavy duty machining]

- Heavy duty chip breaker suitable for Heavy machining in the ship building and power plant industries
- Suitable for large vertical machines when machining shafts, rollers, rotors and optimal for the big flange machining

#### ▶ Special features of VH

- For good chip control in heavy machining (comprehensive type)

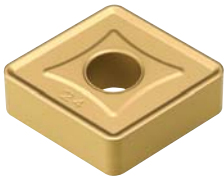

- ▶ Designed from the study of heavy cutting mechanism
- ▶ Smooth chip control from the high rake angle
- ▶ Wider cutting edge land provides stronger cutting
- ▶ Unique cutting edge treatment provides smooth cutting
- ▶ Optimized chip pocket design provides smooth chip flow

#### ▶ Special features of VT

- For long tool life and stable cutting (higher feeds, big depth) in heavy machining



- ▶ Designed from the study of heavy cutting mechanism
- ▶ Strong edge design provides long and stable cutting (2 step rake angle of cutting edge)
- ▶ Varied cutting edge land strengthens the cutting edge
- ▶ The positioning of the chip breaking convex dot deflects the machining heat, optimizes inserts wear & absorb shock

Applications range of Chip breakers

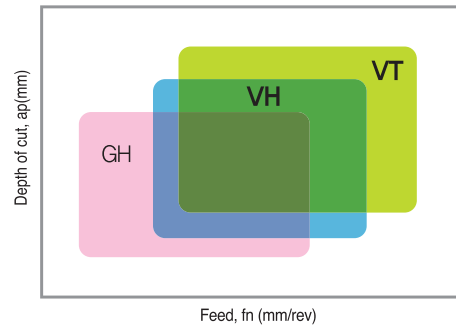

GH :  $ap=5.0\sim 12.0\text{mm}$  /  $fn=0.55\sim 1.20\text{mm/rev}$   
 VH :  $ap=6.0\sim 15.0\text{mm}$  /  $fn=0.70\sim 1.40\text{mm/rev}$   
 VT :  $ap=7.0\sim 17.0\text{mm}$  /  $fn=0.75\sim 1.60\text{mm/rev}$



### LW / VW Chip Breaker [High feed cutting]

- Improved productivity with higher feed rates and surface finishes
- Improved wear resistance and toughness

#### ▶ Special features of LW

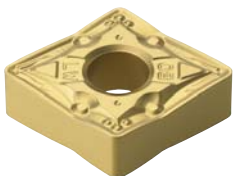

- ▶ **Curvilinear cutting edge**
  - Reduces cutting force
- ▶ **Cutting edge design able to handle deeper depth of cuts**
  - lower cutting load & reduces heat
- ▶ **Greater chip control at shallow depths of cuts**
  - Chip pocket design improves smooth chip flow
- ▶ **For shallow depth cutting and low speed machining**
  - 3D design at the corner

#### ▶ Special features of VW

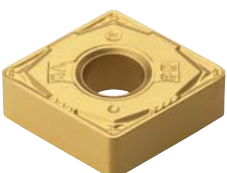

- ▶ **Excellent Finishing applications**
  - Excellent chip control
- ▶ **Insert design great for stable clamping**
  - Chip breaker designed close to the cutting edge
- ▶ **Similar cutting edge to C/B for medium**
  - strong cutting edge
- ▶ **3 Dimensional dot design on cutting corner**
  - reduces cutting force and good chip control at shallow depth of cut

Wiper Insert

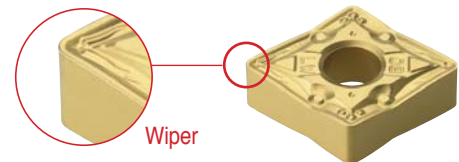

- ▶ High productivity
- ▶ Improved surface roughness
- ▶ High feed-reducing machining time
- ▶ Improved tool life due to reduce cutting force

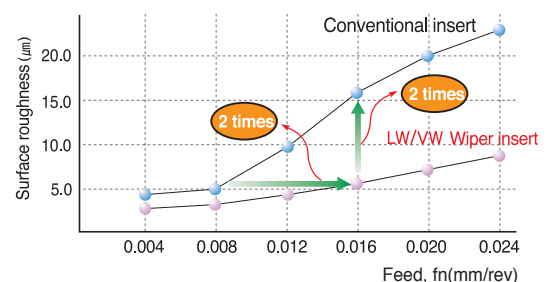



## New Chip Breakers

### VL Chip Breaker [Mild steel]

- Improved chip control for machining material that have high toughness such as low carbon steel, pipe, steel plate etc
- Improved chip control and decreased cutting load on external, facing, and copying applications
- Improved strength of the cutting edge for measurable efficiency in automated production



- ▶ **Special features of VL**
  - ▶ **2 steps designed chip-breaker** - Suitable Mild steel
  - ▶ **Designed with special dots** - Stable chip control on the low feed and cutting depth
  - ▶ **Applied side rake angle** - Stable chip breaking on the low cutting depth
  - Improved chip control on facing, copying applications
  - Decreased cutting load and better surface finish

#### ▶ Chip control test

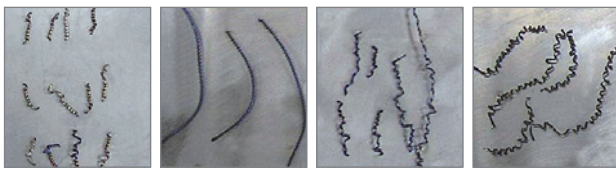

VL Chip Breakers Competitor A Competitor B Competitor C

- **Workpiece** SM20C
- **Cutting conditions** vc=250m/min, ap=0.5mm  
fn=0.2mm/rev(Side), wet
- **Designation** DNMG150408-VL

#### ▶ FEM Cutting simulation analysis in the design

- ▶ For design of geometry, chip shapes and chip flow are predictable
- ▶ Optimal chip breaker design by various cutting conditions and workpieces

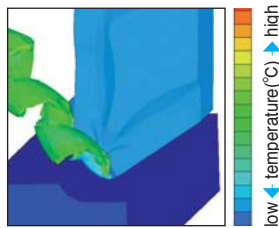

### VB Chip Breaker [Copying]

- Excellent chip evacuation in continuous and high speed machining of various workpieces.
- Longer tool life due to 3 dimensional chip breaker realizing low cutting resistance and high rigidity of the cutting edge.
- Stable chip control in copying and internal machining.

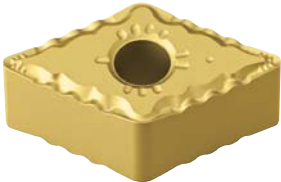

#### ▶ Special features of VB

**6 bumps on the insert corner**  
Superior chip control and chip cutting in copying with various depths of cut

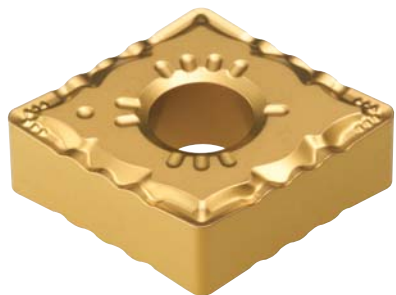

#### Side rake angle

Superb chip cutting in facing and copying  
Superior tool life due to improved surface roughness and lower cutting resistance

#### Cutting edge on 100° part for medium machining (For CNMG)

Excellent chip evacuation and toughness in machining with high depth of cut

#### ▶ Performance

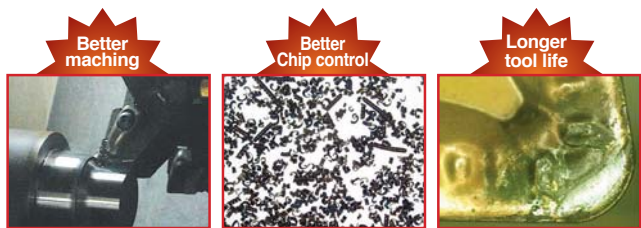

VB Chip Breakers



Conventional chip breaker





## New Chip Breakers

### VC Chip Breaker [Medium-finishing]

- Superior chip evacuation in high speed and continuous machining of various workpieces (carbon steel, alloy steel etc.)
- Korloy 3 dimensional chip breaker ensures longer tool life due to low cutting load and improved cutting edge strength.
- Stable chip control in copying and internal machining



#### ▶ Features of VC chip breaker

##### 4 bums on the insert corner

Excellent chip control in various depths of cut and superb chip cutting in external, internal, copy machining and facing.

#### ▶ Superior chip control in copy machining

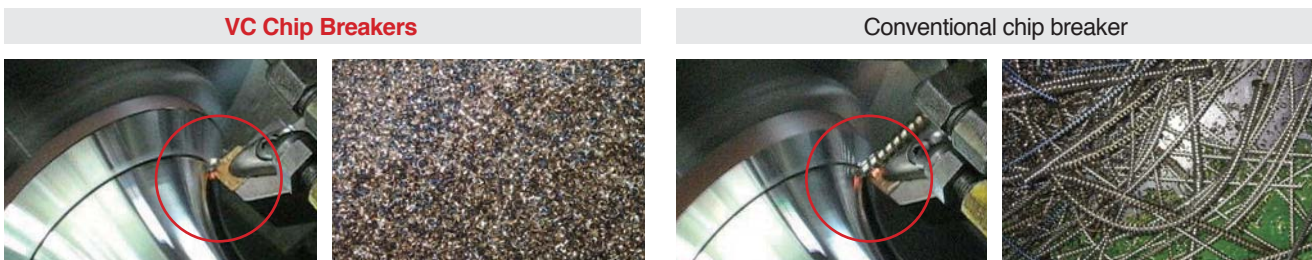

### VP Chip Breaker [For hard-to-cut materials machining]

- High positive cutting edge reduces chip contact
- Minimized temperature while machining ensures longer tool life
- Stable machining with superior chip evacuation in high depths of cut

#### ▶ VP1(for finishing)

##### High positive cutting edge

- ▶ Longer tool life due to minimizing chip contact and reducing cutting heat while machining.
- ▶ Recommended cutting condition •  $f_n=0.05\sim0.2\text{mm/rev}$  •  $a_p=0.1\sim1.5\text{mm}$

#### ▶ VP2(for medium to finishing)

##### High positive cutting edge and side rake angle

- ▶ Improved machining performance with stable chip control in ball machining with various depth of cuts.
- ▶ Recommended cutting condition •  $f_n=0.05\sim0.4\text{mm/rev}$  •  $a_p=0.5\sim4.0\text{mm}$

#### ▶ VP3(for medium machining)

##### High positive cutting edge and wide land

- ▶ Stable machinability in interrupted machining toughness. Stable chip evacuation and machining in machining with high depth of cut.
- ▶ Recommended cutting condition •  $f_n=0.1\sim0.45\text{mm/rev}$  •  $a_p=1.0\sim4.5\text{mm}$

#### ▶ Machining of Hard-to-cut material (Difficulty factors of Hard-to-cut material)

- ▶ Rapid wear on the cutting edge.
- ▶ Frequent fracture and chipping on the cutting edge.
- ▶ High cutting resistance.
- ▶ Rapidly rising temperature on the cutting edge.
- ▶ Increased built-up-edge due to bad chip control.

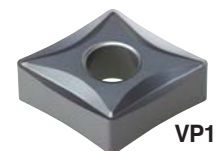

VP1

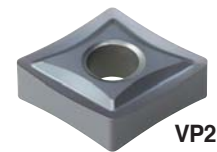

VP2

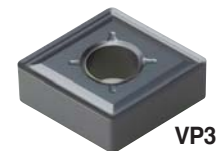

VP3

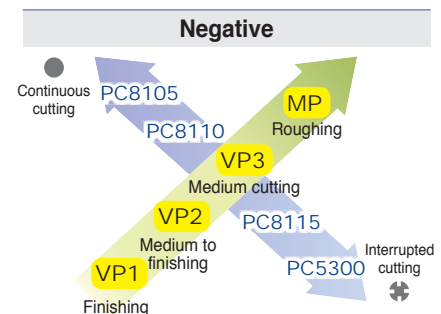

Chip breaker line-up for hard-to-cut materials *Turning*



# B Turning Insert Code System (ISO)

## C

## N

## M

## G

## 12

1

2

3

4

5

Insert Shape

Relief Angle

Tolerance

Cross Section Type

Cutting Edge Length,  
Diameter of Inscribed Circle

### 1 Insert Shape

C N M G 12 04 08 - MP

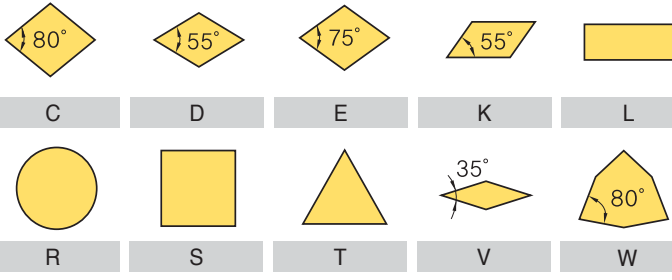

### 2 Relief Angle

C N M G 12 04 08 - MP

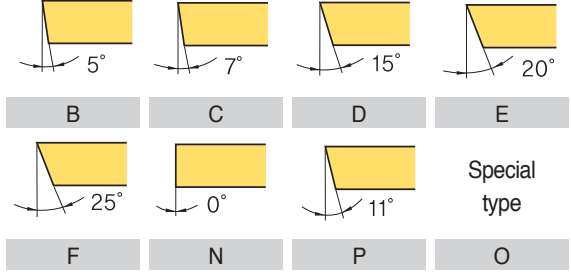

### 3 Tolerance

C N M G 12 04 08 - MP

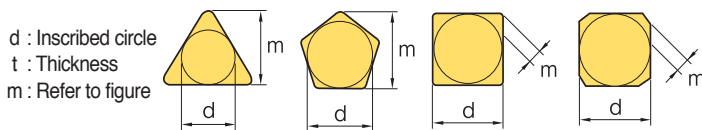

Class	d	m	t
A	±0.025	±0.005	±0.025
C	±0.025	±0.013	±0.025
H	±0.013	±0.013	±0.025
E	±0.025	±0.025	±0.025
G	±0.025	±0.025	±0.13
J*	±0.05 ~ ±0.15	±0.005	±0.025
K*	±0.05 ~ ±0.15	±0.013	±0.025
L*	±0.05 ~ ±0.15	±0.025	±0.025
M*	±0.05 ~ ±0.15	±0.08 ~ ±0.20	±0.13
N*	±0.05 ~ ±0.15	±0.08 ~ ±0.18	±0.025
U*	±0.08 ~ ±0.25	±0.13 ~ ±0.38	±0.13

\* Sides are based on unground insert

#### Tolerance on C,E,H,M,O,P,R,S,T,W Insert Shape (Exceptional case)

d	Tolerance on d		Tolerance on m	
	J, K, L, M, N	U	M, N	U
6.35	±0.05	±0.08	±0.08	±0.13
9.525	±0.05	±0.08	±0.08	±0.13
12.7	±0.08	±0.13	±0.13	±0.20
15.875	±0.10	±0.18	±0.15	±0.27
19.05	±0.10	±0.18	±0.15	±0.27
25.4	±0.13	±0.25	±0.18	±0.38

#### Tolerance on D Insert Shape (Exceptional case)

d	Tolerance on d	Tolerance on m
6.35	±0.05	±0.11
9.525	±0.05	±0.11
12.7	±0.08	±0.15
15.875	±0.10	±0.18
19.05	±0.10	±0.18

### 4 Cross Section Type

C N M G 12 04 08 - MP

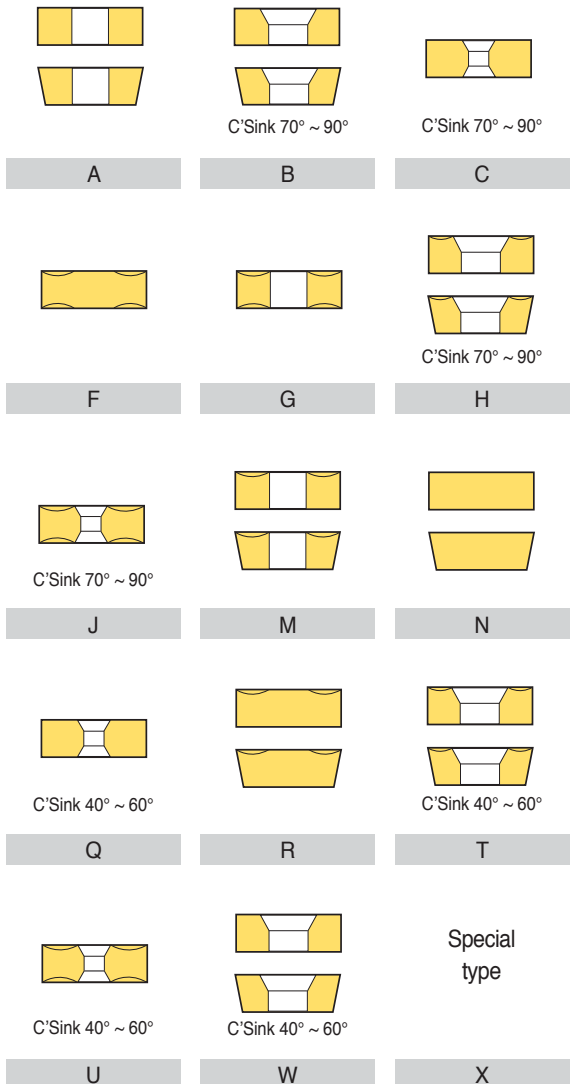

04

08

-

MP

6

7

8

Height of Cutting Edge

Nose Radius (Nose R)

Chip Breaker for Turning

**5** Cutting Edge Length, Diameter of Incribed Circle  
C N M G 12 04 08 - MP

Symbol								Inch	IC d(mm)
C	d	S	T	R	V	W			
03	04	03	06	03	-	02	1.2(5)	3.97	
04	05	04	08	04	08	S3	1.5(6)	4.76	
05	06	05	09	05	09	03	1.8(7)	5.56	
-	-	-	-	06	-	-	-	6.00	
06	07	06	11	06	11	04	2	6.35	
08	09	07	13	07	13	05	2.5	7.94	
-	-	-	-	08	-	-	-	8.00	
09	11	09	16	09	16	06	3	9.525	
-	-	-	-	10	-	-	-	10.00	
11	13	11	19	11	19	07	3.5	11.11	
-	-	-	-	12	-	-	-	12.00	
12	15	12	22	12	22	08	4	12.70	
14	17	14	24	14	24	09	4.5	14.29	
16	19	15	27	15	27	10	5	15.875	
-	-	-	-	16	-	-	-	16.00	
17	21	17	30	17	30	11	5.5	17.46	
19	23	19	33	19	33	13	6	19.05	
-	-	-	-	20	-	-	-	20.00	
22	27	22	38	22	38	15	7	22.225	
-	-	-	-	25	-	-	-	25.00	
25	31	25	44	25	44	17	8	25.40	
32	38	31	54	31	54	21	10	31.75	
-	-	-	-	32	-	-	-	32.00	

( ) Symbol for small size insert

**7** Nose Radius (Nose R)  
C N M G 12 04 08 - MP

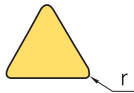

Symbol		Corner Radius	
Metric	Inch	Metric	Inch
01	0	0.1	0.004
02	0.5	0.2	0.008
04	1	0.4	1/64
08	2	0.8	1/32
12	3	1.2	3/64
16	4	1.6	1/16
20	5	2.0	5/64
24	6	2.4	3/32
28	7	2.8	7/64
32	8	3.2	1/8
00	-	Round insert(Inch)	
M0	-	Round insert(Metric)	

**6** Height of Cutting Edge  
C N M G 12 04 08 - MP

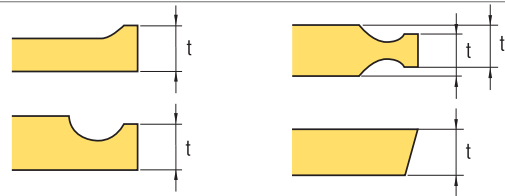

Symbol		Height of Cutting Edge(t)	
Metric	Inch	mm	Inch
01	1(2)	1.59	1/16
T0	1.125	1.79	9/128
T1	1.2	1.98	5/64
02	1.5(3)	2.38	3/32
T2	1.75	2.78	7/64
03	2	3.18	1/8
T3	2.5	3.97	5/32
04	3	4.76	3/16
05	3.5	5.56	7/32
06	4	6.35	1/4
07	5	7.94	5/16
09	6	9.52	3/8
11	7	11.11	7/16
12	8	12.70	1/2

( ) Symbol for small size insert

**8** Chip Breaker for Turning  
C N M G 12 04 08 - MP

Negative Insert Chip Breaker

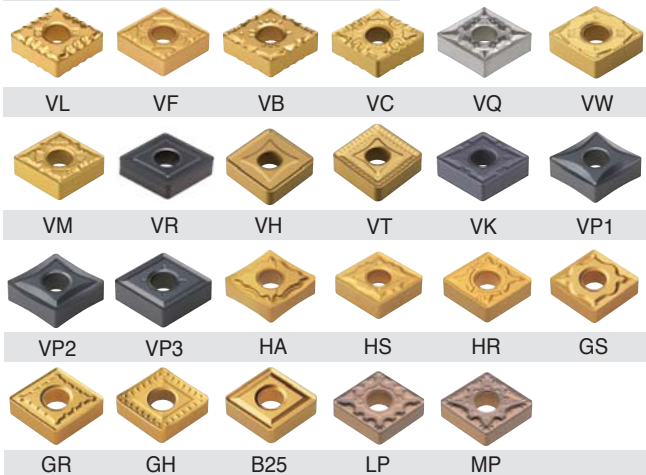

Positive Insert Chip Breaker



# B Turning Insert (Negative)

CN○○○

Rhombic 80° Negative

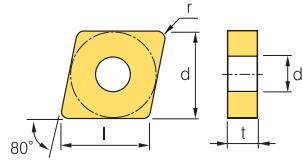

Dimensions(mm)			
Size	d	t	d1
09	9.525	3.18	3.81
12	12.7	4.76	5.16
16	15.875	6.35	6.35
19	19.05	6.35	7.93

Workpiece	Material Compatibility													Machining types					
	Steel	Stainless steel	Cast iron	Non-ferrous metal	Heat resistant alloy, Titanium alloy	Hardened steel	P	M	K	N	S	H	●	⦿	⚡	●	⦿	⚡	
Steel							●	●	●	●	●	●	●	●	●	●	●	●	●
Stainless steel		●					●	●	●	●	●	●	●	●	●	●	●	●	●
Cast iron			●				●	●	●	●	●	●	●	●	●	●	●	●	●
Non-ferrous metal				●			●	●	●	●	●	●	●	●	●	●	●	●	●
Heat resistant alloy, Titanium alloy					●		●	●	●	●	●	●	●	●	●	●	●	●	●
Hardened steel						●	●	●	●	●	●	●	●	●	●	●	●	●	●

Inserts	Designation	Cermets		Coated		Coated											Uncoated		Cutting Condition										
		CN1500	CN2000	CN2500	CC1500	CC2500	NC3010	NC3215	NC3120	NC3220	NC3225	NC3030	NC5330	NC9020	NC9025	NC6205	NC6210	NC6215	PC5300	PC5400	PC8105	PC8110	PC8115	H01	H05	fn (mm/rev)	ap (mm)		
Finishing	VP1	CNMG 120402-VP1																									0.01~0.10	0.10~1.00	
		120404-VP1																									0.05~0.15	0.10~1.50	
		120408-VP1																									0.07~0.20	0.10~1.50	
Roughing	CNMA	090308																									0.10~0.30	0.50~3.00	
		120404																									0.15~0.60	1.00~5.00	
		120408																									0.15~0.60	1.00~6.00	
		120412																									0.15~0.70	1.50~6.00	
		120416																									0.20~0.80	2.00~6.00	
		160608																									0.15~0.70	2.00~6.00	
		160612																									0.15~0.70	2.00~6.00	
		160616																									0.15~0.70	2.00~6.00	
		190608																										0.15~0.70	2.00~10.00
		190612																										0.15~0.70	2.00~10.00
190616																										0.20~1.00	3.00~10.00		
Finishing	VB	CNMG 120404-VB	●		●	●	●	●	●	●	●	●	●	●	●	●	●	●	●	●	●	●	●	●	●	●	0.15~0.35	0.30~2.00	
		120408-VB	●		●	●	●	●	●	●	●	●	●	●	●	●	●	●	●	●	●	●	●	●	●	●	0.15~0.45	0.50~2.00	
		120412-VB						●		●		●														0.20~0.50	0.50~2.00		
Finishing	VF	CNMG 090304-VF					●	●	●	●																	0.07~0.30	0.50~1.50	
		090308-VF																									0.10~0.30	0.50~1.50	
		120404-VF					●	●	●		●																0.07~0.30	0.50~1.50	
		120408-VF					●		●		●																0.10~0.40	0.50~1.50	
		120412-VF																									0.10~0.50	0.60~1.50	
Finishing (Cermets)	VG	CNMG 090304-VG																									0.07~0.30	0.50~1.50	
		090308-VG																									0.10~0.30	0.50~1.50	
		120404-VG	●	●																							0.07~0.30	0.50~1.50	
		120408-VG	●																								0.10~0.40	0.50~1.50	
Finishing (Mild steel)	VL	CNMG 120404-VL	●		●		●		●		●																0.05~0.25	0.10~1.00	
		120408-VL	●		●		●		●		●																0.10~0.35	0.20~1.50	
		120412-VL						●																			0.10~0.35	0.20~1.50	

Cutting edge geometry A38 ~ A43  
 Recommended chip breaker B04 ~ B11  
 Code system B18 ~ B19  
 ● : Stock item

Available tool holders			
Designation	Page	Designation	Page
MCKNR/L	B116	MCRNR/L	B117
MCLNR/L	B116	PCBNR/L	B104
MCMNN	B116	PCLNR/L	B105





CN○○○

**Rhombic 80° Negative**

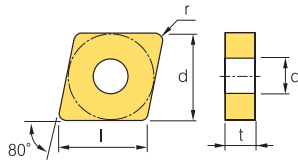

Dimensions(mm)			
Size	d	t	d1
09	9.525	3.18	3.81
12	12.7	4.76	5.16
19	19.05	6.35	7.93

Workpiece	Steel	P	●	●	●	●	●	●	●	●	●	●	●	●	●	●	●	●	●	●	Machining types	
	Stainless steel	M	●	●	●	●	●	●	●	●	●	●	●	●	●	●	●	●	●	●	●	●
Cast iron	K	●	●	●	●	●	●	●	●	●	●	●	●	●	●	●	●	●	●	●	●	●
Non-ferrous metal	N	●	●	●	●	●	●	●	●	●	●	●	●	●	●	●	●	●	●	●	●	●
Heat resistant alloy, Titanium alloy	S	●	●	●	●	●	●	●	●	●	●	●	●	●	●	●	●	●	●	●	●	●
Hardened steel	H	●	●	●	●	●	●	●	●	●	●	●	●	●	●	●	●	●	●	●	●	●

● Continuous cutting  
 ● General cutting  
 ● Interrupted cutting

Inserts	Designation	Cermet		Coated		Coated													Uncoated		Cutting Condition								
		CN1500	CN2000	CN2500	CC1500	CC2500	NC3010	NC3215	NC3120	NC3220	NC3225	NC3030	NC5330	NC9020	NC9025	NC6205	NC6210	PC5300	PC5400	PC8105	PC8110	PC8115	PC9030	H01	H05	fn (mm/rev)	ap (mm)		
Finishing (wiper)	VW	CNMG 120404-VW	●	●	●	●	●	●	●	●	●	●	●	●	●	●	●	●	●	●	●	●	●	●	●	●	0.10~0.30	0.50~3.00	
		120408-VW	●	●	●	●	●	●	●	●	●	●	●	●	●	●	●	●	●	●	●	●	●	●	●	●	0.15~0.50	0.50~4.00	
Medium to finishing	HA	CNMG 120404-HA	●	●	●	●	●	●	●	●	●	●	●	●	●	●	●	●	●	●	●	●	●	●	●	●	0.05~0.20	0.80~3.50	
		120408-HA	●	●	●	●	●	●	●	●	●	●	●	●	●	●	●	●	●	●	●	●	●	●	●	●	0.10~0.40	0.80~3.50	
		120412-HA	●	●	●	●	●	●	●	●	●	●	●	●	●	●	●	●	●	●	●	●	●	●	●	●	0.13~0.55	0.80~3.50	
Medium to finishing	HC	CNMG 120404-HC	●	●	●	●	●	●	●	●	●	●	●	●	●	●	●	●	●	●	●	●	●	●	●	●	0.05~0.30	0.80~3.50	
		120408-HC	●	●	●	●	●	●	●	●	●	●	●	●	●	●	●	●	●	●	●	●	●	●	●	●	0.08~0.40	0.80~4.00	
		120412-HC	●	●	●	●	●	●	●	●	●	●	●	●	●	●	●	●	●	●	●	●	●	●	●	●	0.17~0.50	1.00~4.00	
Medium to finishing	LP	CNMG 120404-LP	●	●	●	●	●	●	●	●	●	●	●	●	●	●	●	●	●	●	●	●	●	●	●	●	0.10~0.35	0.3~2.0	
		120408-LP	●	●	●	●	●	●	●	●	●	●	●	●	●	●	●	●	●	●	●	●	●	●	●	●	0.10~0.40	0.5~2.5	
		120412-LP	●	●	●	●	●	●	●	●	●	●	●	●	●	●	●	●	●	●	●	●	●	●	●	●	0.13~0.45	0.8~3.0	
Medium to finishing	VC	CNMG 120404-VC	●	●	●	●	●	●	●	●	●	●	●	●	●	●	●	●	●	●	●	●	●	●	●	●	0.10~0.35	0.30~2.00	
		120408-VC	●	●	●	●	●	●	●	●	●	●	●	●	●	●	●	●	●	●	●	●	●	●	●	●	0.15~0.40	0.50~3.00	
		120412-VC	●	●	●	●	●	●	●	●	●	●	●	●	●	●	●	●	●	●	●	●	●	●	●	●	0.15~0.45	0.50~3.00	
Medium to finishing	VP2	CNMG 120404-VP2	●	●	●	●	●	●	●	●	●	●	●	●	●	●	●	●	●	●	●	●	●	●	●	●	0.05~0.30	0.10~3.00	
		120408-VP2	●	●	●	●	●	●	●	●	●	●	●	●	●	●	●	●	●	●	●	●	●	●	●	●	0.10~0.40	0.50~4.50	
Medium to finishing	VQ	CNMG 090304-VQ	●	●	●	●	●	●	●	●	●	●	●	●	●	●	●	●	●	●	●	●	●	●	●	●	0.05~0.30	0.50~3.50	
		090308-VQ	●	●	●	●	●	●	●	●	●	●	●	●	●	●	●	●	●	●	●	●	●	●	●	●	0.08~0.30	0.80~4.00	
		120404-VQ	●	●	●	●	●	●	●	●	●	●	●	●	●	●	●	●	●	●	●	●	●	●	●	●	0.05~0.30	0.80~4.00	
		120408-VQ	●	●	●	●	●	●	●	●	●	●	●	●	●	●	●	●	●	●	●	●	●	●	●	●	●	0.08~0.40	0.80~4.00
		120412-VQ	●	●	●	●	●	●	●	●	●	●	●	●	●	●	●	●	●	●	●	●	●	●	●	●	●	0.08~0.40	0.80~4.00
Medium	GM	CNMG 120404-GM	●	●	●	●	●	●	●	●	●	●	●	●	●	●	●	●	●	●	●	●	●	●	●	●	0.05~0.30	0.90~5.00	
		120408-GM	●	●	●	●	●	●	●	●	●	●	●	●	●	●	●	●	●	●	●	●	●	●	●	●	0.10~0.50	1.00~5.00	
		120412-GM	●	●	●	●	●	●	●	●	●	●	●	●	●	●	●	●	●	●	●	●	●	●	●	●	0.18~0.60	1.30~5.00	
		190608-GM	●	●	●	●	●	●	●	●	●	●	●	●	●	●	●	●	●	●	●	●	●	●	●	●	0.10~0.50	1.00~8.00	

↻ Cutting edge geometry A38 ~ A43     
 ↻ Recommended chip breaker B04 ~ B11     
 ↻ Code system B18 ~ B19     
 ● : Stock item

Available tool holders			
Designation	Page	Designation	Page
MCKNR/L	B116	MCRNR/L	B117
MCLNR/L	B116	PCBNR/L	B104
MCMNN	B116	PCLNR/L	B105



# B Turning Insert (Negative)

## CN○○○

Rhombic **80° Negative**

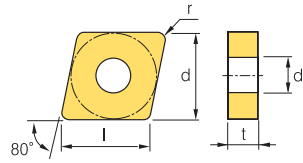

Size	Dimensions(mm)		
	d	t	d1
09	9.525	3.18	3.81
12	12.7	4.76	5.16
16	15.875	6.35	6.35
19	19.05	6.35	7.93

Workpiece	Material		Machining types																				
	Symbol	Color	●	●	●	●	●	●	●	●	●	●	●	●	●	●	●	●	●	●	●	●	●
Steel	<b>P</b>	Blue	●	●	●	●	●	●	●	●	●	●	●	●	●	●	●	●	●	●	●	●	●
Stainless steel	<b>M</b>	Yellow																					
Cast iron	<b>K</b>	Red	●	●	●	●																	
Non-ferrous metal	<b>N</b>	Green																					
Heat resistant alloy, Titanium alloy	<b>S</b>	Orange																					
Hardened steel	<b>H</b>	Grey																					

● Continuous cutting  
● General cutting  
● Interrupted cutting

Inserts	Designation	Cermets		Coated		Coated										Uncoated		Cutting Condition												
		CN1500	CN2000	CN2500	CC1500	CC2500	NC3010	NC3215	NC3120	NC3220	NC3225	NC3030	NC5330	NC9020	NC9025	NC6210	NC6215	PC5300	PC5400	PC8105	PC8110	PC8115	PC9030	H01	H05	fn (mm/rev)	ap (mm)			
Medium <b>HS</b> 	CNMG 090304-HS														●	●											0.05~0.20	1.00~2.50		
	CNMG 090308-HS																											0.10~0.20	1.00~2.50	
	120404-HS														●	●			●			●	●					0.05~0.20	1.00~4.50	
	120408-HS														●	●			●	●		●	●					0.10~0.40	1.00~4.50	
	120412-HS															●			●	●		●	●					0.13~0.55	1.00~4.50	
	160612-HS																											0.13~0.55	2.00~6.00	
	160616-HS																											0.15~0.60	2.00~6.00	
	190612-HS														●				●	●		●	●					0.13~0.55	2.00~7.30	
	190616-HS															●						●	●					0.15~0.60	2.00~7.30	
Medium <b>MP</b> 	CNMG 090304-MP																											0.10~0.40	0.4~3.8	
	CNMG 090308-MP																												0.15~0.40	0.5~4.0
	090312-MP																												0.15~0.50	0.8~4.2
	090404-MP																												0.10~0.40	0.4~3.8
	090408-MP																												0.15~0.40	0.5~4.0
	090412-MP																												0.15~0.50	0.8~4.2
	120404-MP										●			●				●			●	●	●			●		0.10~0.40	0.4~4.0	
	120408-MP										●			●				●			●	●	●			●		0.15~0.45	0.5~4.5	
	120412-MP										●			●				●			●	●	●			●		0.15~0.50	0.8~5.0	
Medium <b>VM</b> 	CNMG 090304-VM																											0.05~0.30	0.90~3.50	
	CNMG 090308-VM																												0.10~0.45	1.00~3.50
	120404-VM										●			●			●			●	●				●			0.05~0.30	0.90~5.00	
	120408-VM										●			●			●			●	●				●			0.10~0.50	1.00~5.00	
	120412-VM										●			●			●			●	●				●			0.13~0.60	1.30~5.00	
	120416-VM																											0.20~0.60	1.50~5.50	
	160608-VM																											0.10~0.50	1.00~6.70	
	160612-VM																											0.13~0.60	1.30~6.70	
	190612-VM																											0.15~0.70	1.50~7.00	
Medium <b>VP3</b> 	CNMG 120404-VP3																											0.05~0.30	0.10~3.00	
	120408-VP3																												0.10~0.40	0.50~4.50
	120412-VP3																												0.12~0.50	0.50~5.00
Medium (wiper) <b>LW</b> 	CNMG 120408-LW																											0.15~0.60	1.00~5.00	
	120412-LW																											0.20~0.70	1.00~6.00	

🔁 Cutting edge geometry A38 ~ A43    ⤵ Recommended chip breaker B04 ~ B11    🔁 Code system B18 ~ B19    ● : Stock item

Available tool holders			
Designation	Page	Designation	Page
MCKNR/L	B116	MCRNR/L	B117
MCLNR/L	B116	PCBNR/L	B104
MCMNN	B116	PCLNR/L	B105



# Turning Insert (Negative) **B**

CN○○○

Rhombic **80° Negative**

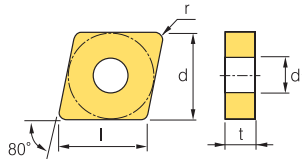

Size	Dimensions(mm)		
	d	t	d1
12	12.7	4.76	5.16
16	15.875	6.35	6.35
19	19.05	6.35	7.93
25	25.4	7.94-9.52	9.12

Workpiece	Machining types															
	Steel	Stainless steel	Cast iron	Non-ferrous metal	Heat resistant alloy, Titanium alloy	Hardened steel										
	<b>P</b>	<b>M</b>	<b>K</b>	<b>N</b>	<b>S</b>	<b>H</b>	●	●	●	●	●	●	●	●	●	●
							●	●	●	●	●	●	●	●	●	●
							●	●	●	●	●	●	●	●	●	●
							●	●	●	●	●	●	●	●	●	●
							●	●	●	●	●	●	●	●	●	●
							●	●	●	●	●	●	●	●	●	●
							●	●	●	●	●	●	●	●	●	●
							●	●	●	●	●	●	●	●	●	●
							●	●	●	●	●	●	●	●	●	●

Inserts	Designation	Cermert		Coated		Coated													Uncoated		Cutting Condition								
		CN1500	CN2000	CN2500	CC1500	CC2500	NC3010	NC3215	NC3120	NC3220	NC3225	NC3030	NC5330	NC9020	NC9025	NC6205	NC6210	NC6215	PC5300	PC5400	PC8105	PC8110	PC9030	H01	H05	fn (mm/rev)	ap (mm)		
Medium to roughing 	CNMG 120404-B25	●	●	●		●	●	●	●	●	●	●	●	●		●	●	●	●	●	●	●	●	●			0.17~0.45	1.00~5.00	
	120408-B25	●	●	●		●	●	●	●	●	●	●	●	●		●	●	●	●	●	●	●	●	●			0.23~0.60	1.50~5.00	
	120412-B25			●		●	●	●	●	●	●	●	●	●		●	●										0.25~0.60	2.00~5.00	
	160608-B25					●	●	●	●	●	●	●	●	●		●	●	●	●	●	●	●	●	●			0.25~0.60	2.00~6.50	
	160612-B25					●	●	●	●	●	●	●	●	●		●	●	●	●	●	●	●	●	●			0.27~0.60	2.00~6.50	
	160616-B25					●	●	●	●	●	●	●	●	●		●	●	●	●	●	●	●	●	●			0.27~0.60	2.00~6.50	
	190604-B25										●	●	●	●													0.20~0.45	3.00~8.00	
	190608-B25						●	●	●	●	●	●	●	●		●	●	●	●	●	●	●	●	●			0.25~0.60	3.00~8.00	
	190612-B25						●	●	●	●	●	●	●	●		●	●	●	●	●	●	●	●	●	●			0.30~0.60	3.00~8.00
190616-B25						●	●	●	●	●	●	●	●		●	●	●	●	●	●	●	●	●	●			0.23~0.70	3.00~8.00	
Medium to roughing 	CNMG 120404-GS														●	●			●								0.05~0.25	0.10~3.00	
	120408-GS														●	●			●								0.10~0.50	1.00~5.00	
	120412-GS														●	●			●								0.13~0.65	1.00~5.00	
	160608-GS																										0.10~0.50	1.00~6.50	
	160612-GS																										0.13~0.65	1.00~6.50	
	190612-GS															●							●				0.13~0.65	1.00~7.80	
	190616-GS																						●				0.13~0.65	1.00~7.80	
Roughing 	CNMG 120408-GR						●	●	●	●	●	●	●		●	●	●										0.20~0.50	1.00~7.00	
	120412-GR						●	●	●	●	●	●	●		●	●	●										0.25~0.50	1.30~7.00	
	120416-GR															●											0.25~0.60	1.80~6.00	
	160608-GR								●		●					●	●										0.20~0.70	1.00~8.00	
	160612-GR						●	●	●	●	●	●	●		●	●	●										0.25~0.70	1.30~8.00	
	160616-GR								●		●					●	●										0.25~0.75	1.80~8.00	
	190608-GR							●	●	●	●	●	●		●	●	●										0.20~0.70	1.70~10.00	
	190612-GR						●	●	●	●	●	●	●		●	●	●										0.30~0.75	1.70~10.00	
	190616-GR						●	●	●	●	●	●	●		●	●	●										0.30~0.80	1.80~10.00	
	190624-GR																											0.35~0.85	2.00~12.00
	250724-GR																											0.40~1.00	2.30~15.00
250924-GR											●	●															0.40~1.00	2.30~15.00	
Roughing 	CNMG 120408-VK														●	●											0.20~0.50	1.00~5.00	
	120412-VK														●	●											0.25~0.50	1.30~6.00	
	120416-VK															●											0.25~0.60	1.80~7.00	

Cutting edge geometry A38 ~ A43 Recommended chip breaker B04 ~ B11 Code system B18 ~ B19 ● : Stock item

Available tool holders			
Designation	Page	Designation	Page
MCKNR/L	B116	MCRNR/L	B114
MCLNR/L	B116	PCBNR/L	B107
MCMNN	B116	PCLNR/L	B105



# B Turning Insert (Negative)



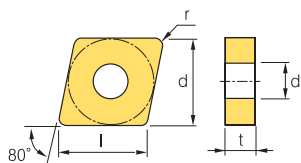

CN○○○

 Rhombic **80° Negative**

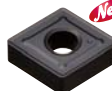

Dimensions(mm)			
Size	d	t	d1
12	12.7	4.76	5.16
16	15.875	6.35	6.35
19	19.05	6.35	7.93
25	25.4	9.52	9.12

Workpiece	Material Compatibility												Machining types		
	Steel	Stainless steel	Cast iron	Non-ferrous metal	Heat resistant alloy, Titanium alloy	Hardened steel	P	M	K	N	S	H	Continuous cutting	General cutting	Interrupted cutting
Steel	●	●	●	●	●	●	●	●	●	●	●	●	●	●	●
Stainless steel	●	●	●	●	●	●	●	●	●	●	●	●	●	●	●
Cast iron	●	●	●	●	●	●	●	●	●	●	●	●	●	●	●
Non-ferrous metal	●	●	●	●	●	●	●	●	●	●	●	●	●	●	●
Heat resistant alloy, Titanium alloy	●	●	●	●	●	●	●	●	●	●	●	●	●	●	●
Hardened steel	●	●	●	●	●	●	●	●	●	●	●	●	●	●	●

Inserts	Designation	Cermets		Coated		Coated										Uncoated		Cutting Condition									
		CN1500	CN2000	CN2500	CC1500	CC2500	NC3010	NC3215	NC3120	NC3220	NC3225	NC3030	NC5330	NC9020	NC9025	NC6205	NC6210	NC6215	PC5300	PC5400	PC8105	PC8110	PC8115	H01	H05	fn (mm/rev)	ap (mm)
Roughing 	CNMG 120404-HR	●	●	●	●	●	●	●	●	●	●	●	●	●	●	●	●	●	●	●	●	●	●	●	●	0.15~0.30	0.80~6.00
	120408-HR	●	●	●	●	●	●	●	●	●	●	●	●	●	●	●	●	●	●	●	●	●	●	●	●	0.20~0.50	1.00~7.00
	120412-HR	●	●	●	●	●	●	●	●	●	●	●	●	●	●	●	●	●	●	●	●	●	●	●	●	0.25~0.70	1.30~7.00
	120416-HR	●	●	●	●	●	●	●	●	●	●	●	●	●	●	●	●	●	●	●	●	●	●	●	●	0.32~0.75	1.80~7.00
	160608-HR	●	●	●	●	●	●	●	●	●	●	●	●	●	●	●	●	●	●	●	●	●	●	●	●	0.20~0.50	1.00~8.00
	160612-HR	●	●	●	●	●	●	●	●	●	●	●	●	●	●	●	●	●	●	●	●	●	●	●	●	0.25~0.70	1.30~8.00
	160616-HR	●	●	●	●	●	●	●	●	●	●	●	●	●	●	●	●	●	●	●	●	●	●	●	●	0.30~0.80	1.80~8.00
	160624-HR	●	●	●	●	●	●	●	●	●	●	●	●	●	●	●	●	●	●	●	●	●	●	●	●	0.32~0.90	2.30~10.00
	190608-HR	●	●	●	●	●	●	●	●	●	●	●	●	●	●	●	●	●	●	●	●	●	●	●	●	0.20~0.50	1.70~10.00
	190612-HR	●	●	●	●	●	●	●	●	●	●	●	●	●	●	●	●	●	●	●	●	●	●	●	●	0.25~0.70	1.30~10.00
	190616-HR	●	●	●	●	●	●	●	●	●	●	●	●	●	●	●	●	●	●	●	●	●	●	●	●	0.30~0.80	1.80~10.00
	190624-HR	●	●	●	●	●	●	●	●	●	●	●	●	●	●	●	●	●	●	●	●	●	●	●	●	0.32~0.90	2.30~10.00
250924-HR	●	●	●	●	●	●	●	●	●	●	●	●	●	●	●	●	●	●	●	●	●	●	●	●	0.40~1.00	2.30~10.00	
Roughing 	CNMG 120408-VR	●	●	●	●	●	●	●	●	●	●	●	●	●	●	●	●	●	●	●	●	●	●	●	●	0.25~0.55	1.2~7.0
	120412-VR	●	●	●	●	●	●	●	●	●	●	●	●	●	●	●	●	●	●	●	●	●	●	●	●	0.30~0.60	1.5~7.0
	120416-VR	●	●	●	●	●	●	●	●	●	●	●	●	●	●	●	●	●	●	●	●	●	●	●	●	0.35~0.65	1.7~7.0
	160612-VR	●	●	●	●	●	●	●	●	●	●	●	●	●	●	●	●	●	●	●	●	●	●	●	●	0.35~0.70	2.0~8.0
	190612-VR	●	●	●	●	●	●	●	●	●	●	●	●	●	●	●	●	●	●	●	●	●	●	●	●	0.35~0.70	2.0~10.0
	190616-VR	●	●	●	●	●	●	●	●	●	●	●	●	●	●	●	●	●	●	●	●	●	●	●	●	0.35~0.75	2.2~10.0
Medium to finishing 	CNMM 120408-HA	●	●	●	●	●	●	●	●	●	●	●	●	●	●	●	●	●	●	●	●	●	●	●	0.10~0.40	0.80~3.50	
Medium 	CNMM 120408-GM	●	●	●	●	●	●	●	●	●	●	●	●	●	●	●	●	●	●	●	●	●	●	●	0.10~0.50	1.00~5.00	
Roughing 	CNMM 120408-GR	●	●	●	●	●	●	●	●	●	●	●	●	●	●	●	●	●	●	●	●	●	●	●	0.20~0.50	1.00~7.00	
	120412-GR	●	●	●	●	●	●	●	●	●	●	●	●	●	●	●	●	●	●	●	●	●	●	●	0.25~0.50	1.30~7.00	
	190612-GR	●	●	●	●	●	●	●	●	●	●	●	●	●	●	●	●	●	●	●	●	●	●	●	0.30~0.75	1.70~10.00	
	190616-GR	●	●	●	●	●	●	●	●	●	●	●	●	●	●	●	●	●	●	●	●	●	●	●	0.30~0.80	1.80~10.00	

 Cutting edge geometry A38 ~ A43     Recommended chip breaker B04 ~ B11     Code system B18 ~ B19    ● : Stock item

Available tool holders			
Designation	Page	Designation	Page
MCKNR/L	B116	MCRNR/L	B117
MCLNR/L	B116	PCBNR/L	B104
MCMNN	B116	PCLNR/L	B105







# B Turning Insert (Negative)

DN ○○

 Rhombic 55° Negative

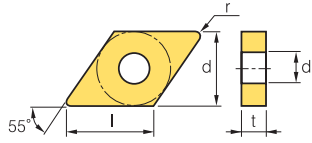

Dimensions(mm)			
Size	d	t	d1
11	9.525	3.18~4.76	3.81
15	12.7	4.76~6.35	5.16
19	15.875	6.35	7.93

Workpiece	Material												Machining types			
	Steel	Stainless steel	Cast iron	Non-ferrous metal	Heat resistant alloy, Titanium alloy	Hardened steel	P	M	K	N	S	H	Continuous cutting	General cutting	Interrupted cutting	
Steel							●	●	●	●	●	●	●	●	●	●
Stainless steel		●	●	●	●	●	●	●	●	●	●	●	●	●	●	●
Cast iron			●	●	●	●	●	●	●	●	●	●	●	●	●	●
Non-ferrous metal				●	●	●	●	●	●	●	●	●	●	●	●	●
Heat resistant alloy, Titanium alloy					●	●	●	●	●	●	●	●	●	●	●	●
Hardened steel							●	●	●	●	●	●	●	●	●	●

Inserts	Designation	Cermets		Coated		Coated										Uncoated		Cutting Condition											
		CN1500	CN2000	CN2500	CC1500	CC2500	NC3010	NC3215	NC3120	NC3220	NC3225	NC3030	NC5330	NC9020	NC9025	NC6205	NC6210	NC6215	PC5300	PC5400	PC8105	PC8110	PC8115	H01	H05	fn (mm/rev)	ap (mm)		
Finishing	VP1	DNMG 150404-VP1																									0.05~0.15	0.10~1.50	
		150408-VP1																									0.07~0.20	0.10~1.50	
		150604-VP1																										0.05~0.15	0.10~1.50
		150608-VP1																										0.07~0.20	0.10~1.50
Roughing	DNMA	110408																									0.17~0.45	0.80~3.00	
		150404																									0.17~0.55	0.40~4.00	
		150408																									0.25~0.55	0.80~4.00	
		150412																										0.25~0.65	0.50~4.00
		150604																										0.17~0.55	0.40~4.00
		150608																										0.25~0.55	0.80~4.00
		150612																										0.25~0.65	1.20~4.00
Finishing	VB	DNMG 150404-VB	●		●	●	●			●	●																0.10~0.35	0.30~2.00	
		150408-VB	●			●	●			●	●	●															0.15~0.45	0.50~2.00	
		150412-VB								●	●	●																0.15~0.45	0.50~2.00
		150604-VB	●		●	●	●			●	●	●																0.10~0.35	0.30~2.00
		150608-VB	●			●	●			●	●	●																0.15~0.45	0.50~2.00
		150612-VB								●	●	●	●															0.20~0.50	0.50~2.50
Finishing	DNMG	110402-VF																									0.05~0.20	0.20~1.00	
		110404-VF																									0.07~0.30	0.50~1.50	
		110408-VF																										0.10~0.40	0.50~1.50
		150404-VF																										0.07~0.30	0.50~1.50
		150408-VF																										0.10~0.40	0.50~1.50
		150412-VF																										0.15~0.50	0.60~1.50
		150604-VF																										0.13~0.30	0.50~1.50
		150608-VF																										0.10~0.40	0.50~1.50
Finishing (Cermets)	DNMG	110404-VG																									0.07~0.30	0.50~1.50	
		110408-VG																									0.10~0.40	0.50~1.50	
		150404-VG																									0.07~0.30	0.50~1.50	
		150408-VG																									0.10~0.40	0.50~1.50	
		150604-VG	●	●																								0.13~0.30	0.50~1.50
150608-VG	●																									0.10~0.40	0.50~1.50		

 Cutting edge geometry A38 ~ A43  
  Recommended chip breaker B04 ~ B11  
  Code system B18 ~ B19  
 ● : Stock item

Available tool holders			
Designation	Page	Designation	Page
MDJNR/L	B117	PDJNR/L	B106, 160
MDNNN	B117	PDNNR/L	B106
MDQNR/L	B118	PDSNR/L	B138
MDUNR/L	B142	PDUNR/L	B139



DN ○ ○

Dimensions(mm)			
Size	d	t	d1
11	9.525	4.76	3.81
15	12.7	4.76~6.35	5.16

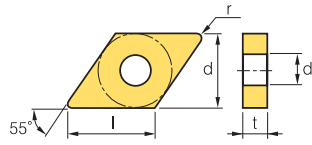

## Rhombic 55° Negative

Workpiece	Steel	P																	Machining types
	Stainless steel	M																	
Cast iron	K																	● Continuous cutting ● General cutting ✱ Interrupted cutting	
Non-ferrous metal	N																		
Heat resistant alloy, Titanium alloy	S																		
Hardened steel	H																		

Inserts	Designation	Cermert		Coated		Coated													Uncoated		Cutting Condition								
		CN1500	CN2000	CN2500	CC1500	CC2500	NC3010	NC3215	NC3120	NC3220	NC3225	NC3030	NC5330	NC9020	NC9025	NC6205	NC6210	NC6215	PC5300	PC5400	PC8105	PC8110	PC9030	H01	H05	fn (mm/rev)	ap (mm)		
Finishing (Mild steel)	VL	DNMG 110408-VL																									0.05~0.20	0.10~1.00	
		150404-VL						●		●	●		●															0.05~0.25	0.10~1.50
		150408-VL								●	●		●															0.05~0.30	0.20~1.50
		150412-VL																										0.10~0.30	0.25~1.50
		150604-VL	●					●		●																		0.05~0.25	0.10~1.50
		150608-VL	●					●		●			●															0.05~0.30	0.20~1.50
		150612-VL																										0.10~0.30	0.25~1.50
Finishing (wiper)	VW	DNMG 150404-VW																									0.10~0.35	0.30~3.00	
		150408-VW																									0.10~0.40	0.30~3.00	
		150604-VW																									0.10~0.35	0.30~3.00	
		150608-VW						●				●															0.10~0.40	0.30~3.00	
Medium to finishing	HA	DNMG 150404-HA																				●	●	●		0.05~0.30	0.80~3.50		
		150408-HA																				●	●	●		0.10~0.40	0.80~3.50		
		150604-HA								●				●								●	●	●		0.05~0.30	0.80~3.50		
		150608-HA																				●	●	●		0.10~0.40	0.80~3.50		
Medium to finishing	HC	DNMG 150404-HC																								0.05~0.30	0.05~3.50		
		150408-HC						●																		0.08~0.40	0.80~4.00		
		150412-HC																								0.13~0.50	0.90~4.00		
		150604-HC																								0.05~0.30	0.80~4.00		
		150608-HC											●													0.08~0.40	0.80~4.00		
		150612-HC																								0.13~0.50	0.90~4.00		
Medium to finishing	LP	DNMG 150404-LP						●		●		●														0.10~0.35	0.3~2.0		
		150408-LP						●		●		●														0.10~0.40	0.5~2.5		
		150412-LP						●		●		●														0.13~0.45	0.8~3.0		
		150604-LP						●		●		●														0.10~0.35	0.3~2.0		
		150608-LP						●		●		●														0.10~0.40	0.5~2.5		
		150612-LP									●															0.13~0.45	0.8~3.0		

Cutting edge geometry A38 ~ A43  
 Recommended chip breaker B04 ~ B11  
 Code system B18 ~ B19  
 ● : Stock item

Available tool holders			
Designation	Page	Designation	Page
MDJNR/L	B117	PDJNR/L	B106, 160
MDNNN	B117	PDNNR/L	B106
MDQNR/L	B118	PDSNR/L	B138
MDUNR/L	B142	PDUNR/L	B139



# B Turning Insert (Negative)

DN ○ ○

 Rhombic 55° Negative

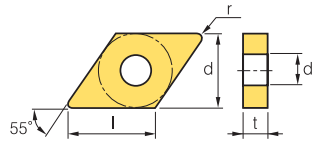

Dimensions(mm)			
Size	d	t	d1
11	9.525	3.18~4.76	3.81
15	12.7	4.76~6.35	5.16

Workpiece	Material Compatibility												Machining types		
	Steel	Stainless steel	Cast iron	Non-ferrous metal	Heat resistant alloy, Titanium alloy	Hardened steel	P	M	K	N	S	H	Continuous cutting	General cutting	Interrupted cutting
Steel	●	●	●	●	●	●	●	●	●	●	●	●	●	●	●
Stainless steel	●	●	●	●	●	●	●	●	●	●	●	●	●	●	●
Cast iron	●	●	●	●	●	●	●	●	●	●	●	●	●	●	●
Non-ferrous metal	●	●	●	●	●	●	●	●	●	●	●	●	●	●	●
Heat resistant alloy, Titanium alloy	●	●	●	●	●	●	●	●	●	●	●	●	●	●	●
Hardened steel	●	●	●	●	●	●	●	●	●	●	●	●	●	●	●

Inserts	Designation	Cermet		Coated		Coated										Uncoated		Cutting Condition											
		CN1500	CN2000	CN2500	CC1500	CC2500	NC3010	NC3215	NC3120	NC3220	NC3225	NC3030	NC5330	NC9020	NC9025	NC6205	NC6210	NC6215	PC5300	PC5400	PC8105	PC8110	PC8115	H01	H05	fn (mm/rev)	ap (mm)		
Medium to finishing	VC	DNMG 150404-VC					●			●																	0.10~0.35	0.30~2.00	
		DNMG 150408-VC						●			●			●														0.15~0.40	0.50~3.00
		DNMG 150412-VC																										0.15~0.45	0.50~3.00
		DNMG 150604-VC						●	●		●	●											●					0.10~0.35	0.30~2.00
		DNMG 150608-VC						●	●		●	●		●														0.15~0.40	0.50~3.00
		DNMG 150612-VC																										0.15~0.45	0.50~3.00
Medium to finishing	VP2	DNMG 150404-VP2																	●	●	●	●	●	●	●	●	0.05~0.30	0.10~3.00	
		DNMG 150408-VP2																	●	●	●	●	●	●	●	●	0.10~0.40	0.50~4.50	
		DNMG 150604-VP2										●							●	●	●	●	●	●	●	●	0.05~0.30	0.10~3.00	
		DNMG 150608-VP2										●							●	●	●	●	●	●	●	●	0.10~0.40	0.50~4.50	
Medium to finishing (Cermet)	VQ	DNMG 110404-VQ	●	●																							0.05~0.30	0.50~3.50	
		DNMG 110408-VQ																										0.08~0.40	0.80~4.00
		DNMG 150404-VQ	●	●	●	●	●																				0.05~0.30	0.80~3.50	
		DNMG 150408-VQ	●	●	●	●	●					●																0.08~0.40	0.80~4.00
		DNMG 150604-VQ	●	●	●	●	●					●																0.05~0.30	0.80~4.00
		DNMG 150608-VQ	●	●	●	●	●					●																0.08~0.40	0.80~4.00
Medium	GM	DNMG 150404-GM																									0.05~0.30	0.90~5.00	
		DNMG 150408-GM	●		●								●														0.10~0.50	1.00~5.00	
		DNMG 150412-GM																										0.13~0.60	1.30~5.00
		DNMG 150604-GM		●	●								●															0.05~0.30	0.90~5.00
		DNMG 150608-GM						●		●			●															0.10~0.50	1.00~5.00
		DNMG 150612-GM											●															0.13~0.60	1.30~5.00
Medium	MP	DNMG 110404-MP																									0.10~0.40	0.4~3.8	
		DNMG 110408-MP																										0.15~0.40	0.5~4.0
		DNMG 110412-MP																										0.15~0.50	0.8~4.2
		DNMG 110504-MP																										0.10~0.40	0.4~3.8
		DNMG 110508-MP																										0.15~0.40	0.5~4.0
		DNMG 110512-MP																										0.15~0.50	0.8~4.2
		DNMG 150404-MP										●		●		●			●			●						0.10~0.40	0.4~4.0
		DNMG 150408-MP										●		●		●			●			●	●	●	●	●		0.15~0.45	0.5~4.5
		DNMG 150412-MP										●		●		●			●			●	●	●	●	●		0.15~0.50	0.8~5.0
		DNMG 150604-MP										●		●		●			●			●	●	●	●	●		0.10~0.40	0.4~4.0
		DNMG 150608-MP										●		●		●			●			●	●	●	●	●		0.15~0.45	0.5~4.5
		DNMG 150612-MP										●		●		●			●			●	●	●	●	●		0.15~0.50	0.8~5.0

 Cutting edge geometry A38 ~ A43  
  Recommended chip breaker B04 ~ B11  
  Code system B18 ~ B19  
 ● : Stock item

Available tool holders			
Designation	Page	Designation	Page
MDJNR/L	B117	PDJNR/L	B106, 160
MDNNN	B117	PDNNR/L	B106
MDQNR/L	B118	PDSNR/L	B138
MDUNR/L	B142	PDUNR/L	B139







# B Turning Insert (Negative)



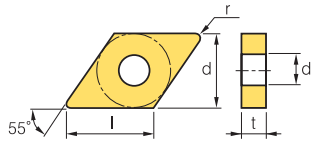

## DN ○○

 Rhombic **55° Negative**



Dimensions(mm)			
Size	d	t	d1
15	12.7	4.76~6.35	5.16

Workpiece	Material Compatibility												Machining types			
	Steel	Stainless steel	Cast iron	Non-ferrous metal	Heat resistant alloy, Titanium alloy	Hardened steel	P	M	K	N	S	H	Continuous cutting	General cutting	Interrupted cutting	
Steel	●	●	●	●	●	●	●	●	●	●	●	●	●	●	●	●
Stainless steel	●	●	●	●	●	●	●	●	●	●	●	●	●	●	●	●
Cast iron	●	●	●	●	●	●	●	●	●	●	●	●	●	●	●	●
Non-ferrous metal	●	●	●	●	●	●	●	●	●	●	●	●	●	●	●	●
Heat resistant alloy, Titanium alloy	●	●	●	●	●	●	●	●	●	●	●	●	●	●	●	●
Hardened steel	●	●	●	●	●	●	●	●	●	●	●	●	●	●	●	●

Inserts	Designation	Cermets		Coated		Coated										Uncoated		Cutting Condition										
		CN1500	CN2000	CN2500	CC1500	CC2500	NC3010	NC3215	NC3120	NC3220	NC3225	NC3030	NC5330	NC9020	NC9025	NC6205	NC6210	NC6215	PC5300	PC5400	PC8105	PC8110	PC9030	H01	H05	fn (mm/rev)	ap (mm)	
Medium to roughing 	DNMG 150402-B25	●																									0.15~0.40	0.50~3.50
	150404-B25			●			●			●	●	●					●										0.17~0.45	1.00~4.00
	150408-B25			●			●		●	●	●	●				●	●										0.17~0.55	1.50~4.00
	150412-B25						●			●		●					●										0.25~0.55	1.50~4.00
	150425-B25																										0.35~0.65	2.50~5.50
	150602-B25																										0.15~0.40	0.50~3.50
	150604-B25		●					●		●	●	●	●				●	●									0.17~0.55	1.50~4.00
	150608-B25		●					●		●	●	●	●				●	●					●	●			0.17~0.55	1.50~4.00
	150612-B25							●			●		●				●	●									0.25~0.55	1.50~4.00
150625-B25																										0.35~0.65	2.50~5.50	
Medium to roughing 	DNMG 150404-GS																										0.07~0.40	1.00~5.00
	150408-GS																		●								0.10~0.50	1.00~5.00
	150412-GS																										0.13~0.65	1.00~5.00
	150604-GS												●										●	●			0.07~0.40	1.00~5.00
	150608-GS																		●				●	●			0.10~0.50	1.00~5.00
	150612-GS																										0.10~0.65	1.00~5.00
Roughing 	DNMG 150408-GR									●		●					●	●									0.20~0.50	1.00~7.00
	150412-GR																	●	●								0.25~0.90	1.30~7.00
	150416-GR																										0.30~0.75	1.80~7.00
	150608-GR										●		●	●				●	●								0.20~0.50	1.00~7.00
	150612-GR										●		●					●	●								0.25~0.70	1.30~7.00
	150616-GR										●		●														0.20~0.75	1.80~7.00
Roughing 	DNMG 150404-VK																	●									0.15~0.50	0.08~6.00
	150408-VK																		●								0.20~0.50	1.00~7.00
	150412-VK																		●	●							0.25~0.70	1.30~7.00
	150604-VK																										0.20~0.50	1.00~7.00
	150608-VK																		●								0.20~0.50	1.00~7.00
	150612-VK																		●	●							0.25~0.70	1.30~7.00

 Cutting edge geometry A38 ~ A43    
  Recommended chip breaker B04 ~ B11    
  Code system B18 ~ B19    
 ● : Stock item

Available tool holders			
Designation	Page	Designation	Page
MDJNR/L	B117	PDJNR/L	B106, 160
MDNNN	B117	PDNNR/L	B106
MDQNR/L	B118	PDSNR/L	B138
MDUNR/L	B142	PDUNR/L	B139









SN ○○

□ Square 90° Negative

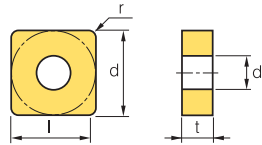

Dimensions(mm)			
Size	d	t	d1
09	9.525	3.18	3.81
12	12.7	4.76	5.16
15	15.875	6.35	6.35
19	19.05	6.35	7.93

Workpiece	Steel	P																	Machining types
	Stainless steel	M																	
Cast iron	K																	● Continuous cutting ● General cutting ✱ Interrupted cutting	
Non-ferrous metal	N																		
Heat resistant alloy, Titanium alloy	S																		
Hardened steel	H																		

Inserts	Designation	Cermet		Coated		Coated											Uncoated		Cutting Condition										
		CN1500	CN2000	CN2500	CC1500	CC2500	NC3010	NC3215	NC3120	NC3220	NC3225	NC3030	NC5330	NC9020	NC9025	NC6205	NC6210	NC6215	PC5300	PC5400	PC8105	PC8110	PC8115	HD1	HD5	fn (mm/rev)	ap (mm)		
Roughing		SNGA 090304																									0.17~0.50	0.50~4.50	
		090308																										0.17~0.50	0.50~4.50
		120404																										0.15~0.60	1.50~8.00
		120408																										0.15~0.60	1.50~8.00
		120412																										0.20~0.80	1.50~8.00
		150608																										0.20~0.80	2.00~10.00
		150616																										0.20~0.90	2.00~10.00
		190608																										0.15~0.60	3.00~12.00
		190612																										0.20~0.80	3.00~12.00
Finishing		SNGG 120408-HU																									0.10~0.30	0.20~1.50	
Medium		SNGG 090304R																									0.12~0.35	1.00~3.00	
		090308R																										0.15~0.35	1.00~3.00
		120404R		●																								0.15~0.35	1.00~4.00
		120408R																										0.15~0.35	1.00~4.00
		120412R																										0.15~0.35	1.00~4.00
		090304L																										0.12~0.35	1.00~3.00
		090308L																										0.15~0.35	1.00~3.00
		120404L																										0.15~0.35	1.00~4.00
		120408L																										0.15~0.35	1.00~4.00
120412L																										0.15~0.35	1.00~4.00		

Cutting edge geometry A38 ~ A43  
 Recommended chip breaker B04 ~ B11  
 Code system B18 ~ B19  
 ● : Stock item

Available tool holders					
Designation	Page	Designation	Page	Designation	Page
MSBNN/L	B118	MSRNR/L	B119	PSDNN	B108
MSDNN	B118	MSSNR/L	B120	PSKNR/L	B109, B139
MSKNR/L	B119	PSBNN/L	B108	PSSNR/L	B109





# SN

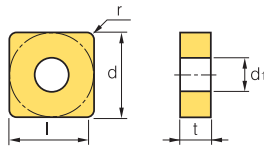

Dimensions(mm)			
Size	d	t	d1
09	9.525	3.18	3.81
12	12.7	4.76	5.16

□ Square **90° Negative**

Workpiece	Steel	P																	Machining types
	Stainless steel	M																	
Cast iron	K																	● Continuous cutting ◐ General cutting ✦ Interrupted cutting	
Non-ferrous metal	N																		
Heat resistant alloy, Titanium alloy	S																		
Hardened steel	H																		

Inserts	Designation	Cermert		Coated		Coated												Uncoated		Cutting Condition					
		CN1500	CN2000	CN2500	CC1500	CC2500	NC3010	NC3215	NC3120	NC3220	NC3225	NC3030	NC5330	NC9020	NC9025	NC6205	NC6210	NC6215	PC5300	PC5400	PC8105	PC8110	PC9030	H01	H05
Finishing	VB	SNMG 120404-VB	●	●	●															0.15~0.35	0.30~2.00				
		120408-VB	●	●	●															0.15~0.40	0.50~2.00				
Finishing	VF	SNMG 090304-VF	●	●	●															0.07~0.30	0.50~1.50				
		090308-VF	●	●	●															0.07~0.30	0.50~1.50				
		120404-VF				●		●													0.07~0.30	0.50~1.50			
		120408-VF				●		●		●										0.10~0.40	0.50~1.50				
		120412-VF				●		●		●										0.20~0.50	0.50~1.50				
Finishing (Cermert)	VG	SNMG 090304-VG	●	●	●															0.07~0.30	0.50~1.50				
		090308-VG	●	●	●															0.10~0.30	0.50~1.50				
		120404-VG				●		●													0.07~0.30	0.50~1.50			
		120408-VG				●		●		●										0.10~0.40	0.50~1.50				
Finishing (Mid steel)	VL	SNMG 120408-VL				●		●													0.10~0.35	0.20~1.50			
Medium to finishing	HA	SNMG 120404-HA																		0.10~0.35	0.80~3.50				
		120408-HA							●											0.10~0.40	0.80~3.50				
		120412-HA							●		●	●	●			0.13~0.55	0.80~3.50								
Medium to finishing	HC	SNMG 120404-HC																		0.05~0.35	0.80~4.00				
		120408-HC																		0.08~0.40	0.80~4.00				
Medium to finishing	LP	SNMG 120404-LP				●		●	●										0.10~0.35	0.3~2.0					
		120408-LP				●		●	●										0.10~0.40	0.5~2.5					
		120412-LP				●		●	●										0.13~0.45	0.8~3.0					

⚙️ Cutting edge geometry **A38 ~ A43**
🔄 Recommended chip breaker **B04 ~ B11**
🔗 Code system **B18 ~ B19**
● : Stock item

Available tool holders					
Designation	Page	Designation	Page	Designation	Page
MSBNR/L	B118	MSRNR/L	B119	PSDNN	B108
MSDNN	B118	MSSNR/L	B120	PSKNR/L	B109, B139
MSKNR/L	B119	PSBNR/L	B108	PSSNR/L	B109



# B Turning Insert (Negative)

## SN

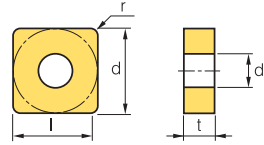

Dimensions(mm)			
Size	d	t	d1
09	9.525	3.18	3.81
12	12.7	4.76	5.16
15	15.875	6.35	6.35
19	19.05	6.35	7.93

Square **90° Negative**

Workpiece	Material														Machining types			
	P	M	K	N	S	H												
Steel	●	●	●	●	●	●	●	●	●	●	●	●	●	●	●	●	●	●
Stainless steel	●	●	●	●	●	●	●	●	●	●	●	●	●	●	●	●	●	●
Cast iron	●	●	●	●	●	●	●	●	●	●	●	●	●	●	●	●	●	●
Non-ferrous metal	●	●	●	●	●	●	●	●	●	●	●	●	●	●	●	●	●	●
Heat resistant alloy, Titanium alloy	●	●	●	●	●	●	●	●	●	●	●	●	●	●	●	●	●	●
Hardened steel	●	●	●	●	●	●	●	●	●	●	●	●	●	●	●	●	●	●

● Continuous cutting  
 ● General cutting  
 ● Interrupted cutting

Inserts	Designation	Cermet		Coated		Coated										Uncoated		Cutting Condition											
		CN1500	CN2000	CN2500	CC1500	CC2500	NC3010	NC3215	NC3120	NC3220	NC3225	NC3030	NC5330	NC9020	NC9025	NC6205	NC6215	P05300	P05400	PC8105	PC8110	PC8115	PC9030	H01	H05	fn (mm/rev)	ap (mm)		
Medium to finishing	VC	SNMG 120408-VC							●	●		●															0.15~0.40	0.50~3.50	
Medium to finishing	VP2	SNMG 120404-VP2																							●		0.05~0.35	0.10~3.00	
		120408-VP2																							●		0.10~0.45	0.50~4.50	
		120412-VP2																							●		0.10~0.50	0.50~5.00	
Medium	GM	SNMG 120404-GM																									0.05~0.30	0.90~5.00	
		120408-GM	●				●					●															0.10~0.50	1.00~5.00	
		120412-GM										●																0.13~0.60	1.30~5.00
Medium	HS	SNMG 090304-HS																									0.05~0.25	1.00~2.50	
		090308-HS																										0.10~0.30	1.00~2.50
		120404-HS																										0.05~0.30	1.00~4.50
		120408-HS																										0.10~0.40	1.00~4.50
		120412-HS																										0.13~0.55	1.00~4.50
		150612-HS																										0.13~0.55	1.00~6.10
		150616-HS																										0.15~0.60	1.00~4.50
		190612-HS																										0.13~0.55	1.00~7.60
190616-HS																										0.15~0.60	1.00~7.60		
Medium	MP	SNMG 090304-MP																									0.10~0.40	0.4~3.8	
		090308-MP																										0.15~0.40	0.5~4.0
		090404-MP																										0.10~0.40	0.4~3.8
		090408-MP																										0.15~0.40	0.5~4.0
		120404-MP																										0.10~0.40	0.4~4.0
		120408-MP																										0.15~0.45	0.5~4.5
		120412-MP																										0.15~0.50	0.8~5.0

Cutting edge geometry A38 ~ A43   
 Recommended chip breaker B04 ~ B11   
 Code system B18 ~ B19   
 ● : Stock item

Available tool holders					
Designation	Page	Designation	Page	Designation	Page
MSBNR/L	B118	MSRNR/L	B119	PSDNN	B108
MSDNN	B118	MSSNR/L	B120	PSKNR/L	B109, B139
MSKNR/L	B119	PSBNR/L	B108	PSSNR/L	B109





# SN

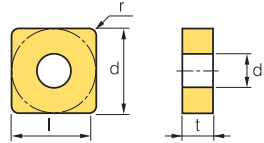

Dimensions(mm)			
Size	d	t	d1
09	9.525	3.18	3.81
12	12.7	4.76	5.16
15	15.875	6.35	6.35
19	19.05	6.35	7.93
25	25.4	7.94	9.12

**○ Square 90° Negative**

Workpiece	Steel	P																	Machining types
	Stainless steel	M																	
Cast iron	K																	● Continuous cutting ● General cutting ✳ Interrupted cutting	
Non-ferrous metal	N																		
Heat resistant alloy, Titanium alloy	S																		
Hardened steel	H																		

Inserts	Designation	Cermet		Coated		Coated													Uncoated		Cutting Condition								
		CN1500	CN2000	CN2500	CC1500	CC2500	NC3010	NC3215	NC3120	NC3220	NC3225	NC3030	NC5330	NC9020	NC9025	NC6210	NC6215	PC5300	PC5400	PC8105	PC8110	PC8115	PC9030	H01	H05	fn (mm/rev)	ap (mm)		
Medium VM	SNMG 090304-VM																										0.05~0.30	0.90~3.50	
	SNMG 090308-VM																											0.10~5.00	1.00~3.50
	SNMG 120404-VM	●					●		●	●	●	●					●	●									0.05~0.30	0.90~5.00	
	SNMG 120408-VM	●							●	●	●	●				●	●	●		●		●					0.10~0.50	1.00~5.00	
	SNMG 120412-VM									●		●				●	●						●				0.13~0.60	1.30~5.00	
	SNMG 190612-VM																										0.25~0.60	2.50~7.50	
Medium VP3	SNMG 120404-VP3																●	●	●	●	●			●	●	0.05~0.30	0.10~3.00		
	SNMG 120408-VP3																●	●	●	●	●			●	●	0.10~0.45	1.00~5.00		
	SNMG 120412-VP3																●	●	●	●	●			●	●	0.12~0.50	1.00~5.00		
Medium (Cermet) VQ	SNMG 090304-VQ																										0.05~0.30	0.50~3.50	
	SNMG 090308-VQ																										0.08~0.30	0.80~4.00	
	SNMG 120404-VQ	●	●																								0.05~0.30	0.80~4.00	
	SNMG 120408-VQ	●	●							●																	0.08~0.40	0.80~4.00	
Medium to roughing B25	SNMG 090308-B25																										0.17~0.45	0.80~3.50	
	SNMG 120404-B25	●	●					●	●	●	●	●				●											0.17~0.45	1.00~3.50	
	SNMG 120408-B25	●	●					●	●	●	●	●				●	●	●	●				●			0.23~0.60	1.50~5.00		
	SNMG 120412-B25		●					●	●	●	●	●				●	●										0.25~0.60	2.00~5.00	
	SNMG 120416-B25							●		●	●	●				●											0.35~0.70	2.50~5.00	
	SNMG 120420-B25																										0.40~0.70	3.00~5.00	
	SNMG 150608-B25											●															0.25~0.60	1.50~6.00	
	SNMG 150612-B25									●																	0.25~0.60	2.00~6.00	
	SNMG 150616-B25									●	●																0.35~0.70	2.00~6.00	
	SNMG 190608-B25								●		●	●					●										0.25~0.60	3.00~8.00	
	SNMG 190612-B25								●		●	●	●				●	●									0.30~0.60	3.00~8.00	
	SNMG 190616-B25								●		●	●					●										0.35~0.70	3.00~8.00	
	SNMG 250716-B25																										0.35~0.70	4.00~12.00	
SNMG 250724-B25								●			●															0.50~1.00	5.00~12.00		
SNMG 250924-B25								●																					
Medium to roughing GS	SNMG 120404-GS																●										0.10~0.45	0.80~4.50	
	SNMG 120408-GS																●	●			●			●			0.10~0.50	1.00~5.00	
	SNMG 120412-GS																●										0.13~0.65	1.00~5.00	
	SNMG 120416-GS																										0.15~0.70	1.00~5.00	
	SNMG 190612-GS																	●	●								0.30~0.80	1.70~9.00	

Cutting edge geometry A38 ~ A43   
 Recommended chip breaker B04 ~ B11   
 Code system B18 ~ B19   
 ● : Stock item

Available tool holders					
Designation	Page	Designation	Page	Designation	Page
MSBNR/L	B118	MSRNR/L	B119	PSDNN	B108
MSDNN	B118	MSSNR/L	B120	PSKNR/L	B109, B139
MSKNR/L	B119	PSBNR/L	B108	PSSNR/L	B109



# B Turning Insert (Negative)

## SN

Square **90° Negative**

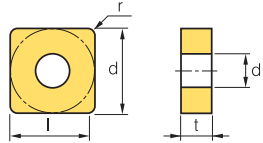

Dimensions(mm)			
Size	d	t	d1
12	12.7	4.76	5.16
15	15.875	6.35	6.35
19	19.05	6.35	7.93
25	25.4	7.94~9.52	9.12

Workpiece	Material												Machining types				
	Steel	Stainless steel	Cast iron	Non-ferrous metal	Heat resistant alloy, Titanium alloy	Hardened steel	P	M	K	N	S	H	●	●	✦	●	
Steel							●	●	✦	●	●	●	●	●	●	●	●
Stainless steel																	
Cast iron							●	●	✦	●	●						
Non-ferrous metal																	
Heat resistant alloy, Titanium alloy																	
Hardened steel																	

Inserts	Designation	Cermets		Coated		Coated										Uncoated		Cutting Condition											
		CN1500	CN2000	CN2500	CC1500	CC2500	NC3010	NC3215	NC3120	NC3220	NC3225	NC3030	NC5330	NC9020	NC9025	NC6205	NC6210	NC6215	PC5300	PC5400	PC8105	PC8110	PC8115	H01	H05	fn (mm/rev)	ap (mm)		
Roughing	GR	SNMG 120404-GR																								0.15~0.45	0.08~6.00		
		120408-GR																								0.20~0.50	1.00~7.00		
		120412-GR																									0.20~0.50	1.00~7.00	
		150608-GR																									0.25~0.60	1.00~7.00	
		150612-GR																									0.29~0.75	1.40~7.00	
		190608-GR																									0.30~0.80	1.70~9.00	
		190612-GR																									0.30~0.80	1.70~9.00	
		190616-GR																										0.31~0.82	1.90~12.30
		250724-GR																										0.45~1.20	2.60~14.00
		250924-GR																										0.50~1.20	2.60~14.00
Roughing	HR	SNMG 120408-HR																									0.20~0.50	1.00~7.00	
		120412-HR																									0.25~0.70	1.30~7.00	
		120416-HR																									0.32~0.75	1.80~7.00	
		150608-HR																									0.20~0.50	1.80~8.00	
		150612-HR																									0.20~0.70	1.30~8.00	
		150616-HR																									0.30~0.80	1.80~8.00	
		150624-HR																									0.32~0.90	2.20~8.00	
		190608-HR																										0.20~0.50	1.00~10.00
		190612-HR																										0.25~0.70	1.30~10.00
		190616-HR																										0.30~0.80	1.80~10.00
190624-HR																										0.32~0.90	2.30~10.00		
Roughing	VK	SNMG 120404-VK																									0.15~0.50	0.08~8.00	
		120408-VK																									0.20~0.50	1.00~7.00	
		120412-VK																									0.20~0.50	1.00~7.00	
Roughing	VR	SNMG 120408-VR																									0.25~0.55	1.2~7.0	
		120412-VR																									0.30~0.60	1.5~7.0	
		190612-VR																									0.35~0.70	2.0~10.0	
		190616-VR																									0.35~0.75	2.2~10.0	
Medium	GM	SNMM 120408-GM																									0.10~0.50	1.00~5.00	
		120412-GM																									0.13~0.60	1.30~5.00	

Cutting edge geometry A38 ~ A43    
 Recommended chip breaker B04 ~ B11    
 Code system B18 ~ B19    
 ● : Stock item

Available tool holders					
Designation	Page	Designation	Page	Designation	Page
MSBNN/L	B118	MSRNN/L	B119	PSSNN/L	B109
MSDNN	B118	MSSNN/L	B120	PSDNN	B108
MSKNR/L	B119	PSBNR/L	B108	PSKNR/L	B109, B139





# B Turning Insert (Negative)

SN ○ ○

□ Square 90° Negative

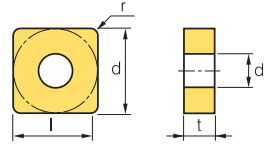

Dimensions(mm)			
Size	d	t	d1
12	12.7	3.18~4.76	5.16
15	15.875	4.76	-
19	19.05	4.76	-
25	25.4	7.94	-

Workpiece	Material												Machining types				
	Steel	Stainless steel	Cast iron	Non-ferrous metal	Heat resistant alloy, Titanium alloy	Hardened steel	P	M	K	N	S	H	●	●	✦	●	
Steel							●	●	●	●	●	●	●	●	●	●	●
Stainless steel		●					●	●	●	●	●	●	●	●	●	●	●
Cast iron			●				●	●	●	●	●	●	●	●	●	●	●
Non-ferrous metal				●			●	●	●	●	●	●	●	●	●	●	●
Heat resistant alloy, Titanium alloy					●		●	●	●	●	●	●	●	●	●	●	●
Hardened steel						●	●	●	●	●	●	●	●	●	●	●	●

Inserts	Designation	Cermet		Coated		Coated										Uncoated		Cutting Condition											
		CN1500	CN2000	CN2500	CC1500	CC2500	NC3010	NC3215	NC3120	NC3220	NC3225	NC3030	NC5330	NC9020	NC9025	NC6205	NC6210	NC6215	PC5300	PC5400	PC8105	PC8110	PC8115	H01	H05	fn (mm/rev)	ap (mm)		
Medium to roughing	SNMN	120304																									0.17~0.45	1.00~3.50	
		120308																									0.23~0.60	1.50~6.00	
		120312																									0.25~0.60	2.00~5.00	
		120404																									0.17~0.45	1.00~3.50	
		120408																									0.23~0.60	1.50~5.00	
		120412																									0.25~0.60	2.00~5.00	
		150404																									0.20~0.50	1.50~6.00	
		150408																										0.25~0.60	1.50~6.00
		150412																										0.25~0.60	2.00~6.00
		190416																										0.35~0.70	2.00~6.00
Medium	SNMX	120408R																									0.15~0.35	1.00~4.00	
Medium to roughing	SNUN	120408																									0.23~0.60	1.50~5.00	
		120412																									0.25~0.60	2.00~5.00	
		190412																									0.30~1.00	3.00~10.00	
		120412TN																									0.25~0.60	2.00~5.00	
		250724TN																									0.30~1.20	3.00~12.00	

Cutting edge geometry A38 ~ A43    
 Recommended chip breaker B04 ~ B11    
 Code system B18 ~ B19    
 ● : Stock item

Available tool holders					
Designation	Page	Designation	Page	Designation	Page
MSBNR/L	B118	MSRNR/L	B119	PSSNR/L	B109
MSDNN	B118	MSSNR/L	B120	PSDNN	B108
MSKNR/L	B119	PSBNR/L	B108	PSKNR/L	B109, B139





## Triangular 60° Negative

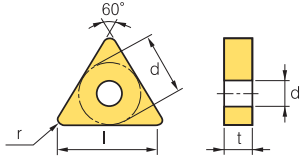

Dimensions(mm)			
Size	d	t	d1
11	6.35	3.18	2.40
16	9.525	3.18~4.76	3.81
22	12.7	4.76	5.16
27	15.875	6.35	6.35

Workpiece	Machining types												
	P	M	K	N	S	H	●	◐	◑	◒	◓	◔	◕
Steel	●	●	●	●	●	●	●	●	●	●	●	●	●
Stainless steel	●	●	●	●	●	●	●	●	●	●	●	●	●
Cast iron	●	●	●	●	●	●	●	●	●	●	●	●	●
Non-ferrous metal	●	●	●	●	●	●	●	●	●	●	●	●	●
Heat resistant alloy, Titanium alloy	●	●	●	●	●	●	●	●	●	●	●	●	●
Hardened steel	●	●	●	●	●	●	●	●	●	●	●	●	●

Inserts	Designation	Cermet		Coated		Coated											Uncoated		Cutting Condition										
		CN1500	CN2000	CN2500	CC1500	CC2500	NC3010	NC3215	NC3120	NC3220	NC3225	NC3030	NC5330	NC9020	NC9025	NC6205	NC6210	NC6215	PC5300	PC5400	PC8105	PC8110	PC8115	HO1	HO5	fn (mm/rev)	ap (mm)		
Roughing	TNGA 110302																									0.05~0.30	0.20~3.00		
	110304																										0.05~0.30	0.40~3.00	
	160304																										0.10~0.35	0.40~4.00	
	160402																										0.10~0.30	0.20~4.00	
	160404	●																									0.10~0.35	0.40~5.00	
	160408																										0.12~0.40	0.50~5.00	
	220304																										0.10~0.35	0.50~5.00	
	220402																											0.05~0.30	0.20~3.00
	220404																											0.10~0.35	0.40~5.00
	220408																											0.10~0.40	0.50~5.00
	220412																											0.12~0.45	1.00~5.50
	270612																											0.12~0.45	1.00~7.00
270624																											0.20~0.55	2.00~7.00	
Finishing	TNGG 160402R-SC	●																									0.03~0.20	0.10~1.50	
	160404R-SC	●																										0.05~0.25	0.30~2.00
	160402L-SC																											0.03~0.20	0.10~1.50
	160404L-SC																											0.05~0.25	0.30~2.00
Medium	TNGG 110304R																										0.05~0.30	0.50~2.50	
	160402R	●																									0.08~0.30	0.50~3.50	
	160404R	●	●																								0.12~0.30	1.00~3.50	
	160408R	●																									0.15~0.35	1.30~3.50	
	220404R	●																									0.12~0.30	1.00~5.00	
	220408R	●																									0.15~0.35	1.30~5.00	
	220412R																										0.17~0.40	1.50~5.00	
	110304L																										0.05~0.30	0.50~2.50	
	160402L																										0.08~0.30	0.50~3.50	
	160404L	●	●																								0.12~0.30	1.00~3.50	
	160408L	●																									0.15~0.35	1.30~3.50	
	220404L																										0.12~0.30	1.00~5.00	
	220408L																										0.15~0.35	1.30~5.00	
	220412L																										0.17~0.40	1.50~5.00	

Cutting edge geometry **A38 ~ A43**
 Recommended chip breaker **B04 ~ B11**
 Code system **B18 ~ B19** 
 ● : Stock item

Available tool holders			
Designation	Page	Designation	Page
MTENN	B120	PTGNR/L	B110
MTFNR/L	B120	PTTNR/L	B111
MTGNR/L	B121	WTENN	B112
MTJNR/L	B121	WTJNR/L	B112
PTFNR/L	B110,140	WTXNR/L	B112





# B Turning Insert (Negative)

TN ○ ○

Triangular 60° Negative

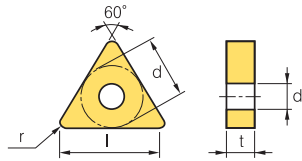

Dimensions(mm)			
Size	d	t	d1
11	6.35	3.18	2.40
16	9.525	3.18~4.76	3.81
22	12.7	4.76	5.16
27	15.875	6.35	6.35
33	15.875	9.52	7.93

Workpiece											Machining types			
	Steel	Stainless steel	Cast iron	Non-ferrous metal	Heat resistant alloy, Titanium alloy	Hardened steel								
	P	M	K	N	S	H								

● Continuous cutting  
● General cutting  
✦ Interrupted cutting

Inserts	Designation	Cermet		Coated		Coated										Uncoated		Cutting Condition										
		CN1500	CN2000	CN2500	CC1500	CC2500	NC3010	NC3215	NC3120	NC3220	NC3225	NC3030	NC5330	NC9020	NC9025	NC6205	NC6210	NC6215	PC5300	PC5400	PC8105	PC8110	PC8115	H01	H05	fn (mm/rev)	ap (mm)	
Medium	TNGN	110302																								0.05~0.25	0.20~2.50	
		110304																									0.10~0.30	0.50~2.50
		110308																									0.10~0.30	0.80~2.50
		160302																									0.05~0.30	0.20~3.00
		160304																									0.10~0.30	0.50~4.00
		160308																									0.10~0.40	0.80~4.00
		160404																									0.10~0.40	0.50~4.00
		160408																									0.10~0.40	1.00~4.00
		160412																									0.10~0.50	1.50~4.50
		220404																									0.10~0.35	1.00~4.00
		220408																									0.15~0.40	1.50~5.00
		220412																									0.20~0.50	1.50~5.00
		220416																									0.25~0.55	1.50~5.00
		220424																									0.30~0.65	2.00~5.00
270630																									0.35~0.70	2.00~5.00		
Roughing	TNMA	110308																								0.05~0.30	0.50~3.00	
		160404																								0.10~0.30	1.00~4.00	
		160408																									0.10~0.40	1.00~4.00
		160412																									0.10~0.50	1.50~4.50
		160416																									0.15~0.55	1.50~4.50
		220404																									0.10~0.35	1.00~4.00
		220408																									0.15~0.40	1.50~5.00
		220412																									0.20~0.50	1.50~5.00
		220416																									0.25~0.55	1.50~5.00
		220420																									0.30~0.65	2.00~5.00
		220432																									0.35~0.70	2.00~5.00
		270608																									0.20~0.45	2.00~7.00
		270612																									0.25~0.55	3.00~7.00
		270616																									0.30~0.65	3.00~7.00
330924																									0.35~0.75	3.00~9.00		
Finishing	TNMG	160404-VB																								0.10~0.35	0.30~1.50	
		160408-VB																								0.15~0.45	0.50~7.00	
		220408-VB																								0.15~0.45	0.50~2.50	
		220412-VB																								0.20~0.50	0.70~2.50	

🔄 Cutting edge geometry A38 ~ A43    🔄 Recommended chip breaker B04 ~ B11    🔄 Code system B18 ~ B19    ● : Stock item

Available tool holders			
Designation	Page	Designation	Page
MTENN	B120	PTGNNR/L	B110
MTFNRR/L	B120	PTTNNR/L	B111
MTGNRR/L	B121	WTENN	B112
MTJNNR/L	B121	WTJNNR/L	B112
PTFNRR/L	B110,140	WTXNNR/L	B112



TN ○ ○

## Triangular 60° Negative

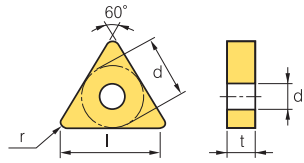

Dimensions(mm)			
Size	d	t	d1
11	6.35	3.18	2.40
16	9.525	4.76	3.81
22	12.7	4.76	5.16

Workpiece	Steel	P															Machining types
	Stainless steel	M															
Cast iron	K															● Continuous cutting ● General cutting ✳ Interrupted cutting	
Non-ferrous metal	N																
Heat resistant alloy, Titanium alloy	S																
Hardened steel	H																

Inserts	Designation	Cermet		Coated		Coated												Uncoated		Cutting Condition									
		CN1500	CN2000	CN2500	CC1500	CC2500	NC3010	NC3215	NC3120	NC3220	NC3225	NC3030	NC5330	NC9020	NC9025	NC6205	NC6210	NC6215	PC5300	PC5400	PC8105	PC8110	PC9030	HD1	H05	fn (mm/rev)	ap (mm)		
Finishing	VL	TNMG 160404-VL	●				●			●																	0.05~0.25	0.10~1.00	
		TNMG 160408-VL	●				●			●																	0.10~0.35	0.20~1.50	
		TNMG 160412-VL																										0.15~0.40	0.20~1.50
		TNMG 220408-VL																										0.10~0.35	0.20~1.50
		TNMG 220412-VL																										0.10~0.35	0.50~2.00
Finishing	VF	TNMG 110304-VF	●	●										●													0.05~0.20	0.20~1.00	
		TNMG 160404-VF	●	●				●		●				●												●	0.07~0.30	0.50~1.50	
		TNMG 160408-VF						●	●	●				●														0.10~0.40	0.50~1.50
		TNMG 160412-VF																										0.15~0.50	0.50~1.50
		TNMG 220404-VF																								●	0.10~0.40	0.50~1.50	
		TNMG 220408-VF																										0.10~0.40	0.50~1.50
Finishing (Cermet)	VG	TNMG 110304-VG	●	●																							0.05~0.20	0.20~1.00	
		TNMG 160404-VG	●	●																							0.07~0.30	0.50~1.50	
		TNMG 160408-VG	●																									0.10~0.40	0.50~1.50
		TNMG 220404-VG																										0.10~0.40	0.50~1.50
Finishing (wiper)	VW	TNMG 160404-VW																									0.10~0.35	0.30~3.00	
		TNMG 160408-VW															●										0.10~0.40	0.30~3.00	
Medium to finishing	HA	TNMG 160404-HA												●											●	●	●	0.05~0.30	0.80~3.50
		TNMG 160408-HA												●	●										●	●	●	0.10~0.40	0.80~3.50
		TNMG 160412-HA																										0.13~0.55	0.80~3.50
		TNMG 220408-HA																								●		0.10~0.40	0.80~5.30
Medium to finishing	HC	TNMG 160404-HC					●						●														0.05~0.35	0.50~3.50	
		TNMG 160408-HC					●		●				●	●													0.08~0.40	0.80~4.00	
		TNMG 160412-HC																										0.13~0.50	0.90~4.00
		TNMG 220408-HC																										0.08~0.40	0.80~4.00

🔄 Cutting edge geometry A38 ~ A43
🔄 Recommended chip breaker B04 ~ B11
🔄 Code system B18 ~ B19
● : Stock item

Available tool holders			
Designation	Page	Designation	Page
MTENN	B120	PTGNR/L	B110
MTFNR/L	B120	PTTNR/L	B111
MTGNR/L	B121	WTENN	B112
MTJNR/L	B121	WTJNR/L	B112
PTFNR/L	B110,140	WTXNR/L	B112



# B Turning Insert (Negative)

## TN ○ ○

Triangular 60° Negative

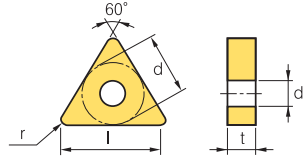

Dimensions(mm)			
Size	d	t	d1
16	9.525	3.18~4.76	3.81
22	12.7	4.76	5.16

Workpiece	Material												Machining types														
	Steel	P	M	K	N	S	H	NC3010	NC3215	NC3120	NC3220	NC3225	NC3030	NC5330	NC9020	NC9025	NC6210	NC6215	P05300	P05400	PC8105	PC8110	PC8115	PC9030	H01	H05	
Steel	●	●	●	●	●	●	●	●	●	●	●	●	●	●	●	●	●	●	●	●	●	●	●	●	●	●	●
Stainless steel	●	●	●	●	●	●	●	●	●	●	●	●	●	●	●	●	●	●	●	●	●	●	●	●	●	●	●
Cast iron	●	●	●	●	●	●	●	●	●	●	●	●	●	●	●	●	●	●	●	●	●	●	●	●	●	●	●
Non-ferrous metal	●	●	●	●	●	●	●	●	●	●	●	●	●	●	●	●	●	●	●	●	●	●	●	●	●	●	●
Heat resistant alloy, Titanium alloy	●	●	●	●	●	●	●	●	●	●	●	●	●	●	●	●	●	●	●	●	●	●	●	●	●	●	●
Hardened steel	●	●	●	●	●	●	●	●	●	●	●	●	●	●	●	●	●	●	●	●	●	●	●	●	●	●	●

Inserts	Designation	Cermert		Coated		Coated										Uncoated		Cutting Condition												
		CN1500	CN2000	CN2500	CC1500	CC2500	NC3010	NC3215	NC3120	NC3220	NC3225	NC3030	NC5330	NC9020	NC9025	NC6210	NC6215	P05300	P05400	PC8105	PC8110	PC8115	PC9030	H01	H05	fn (mm/rev)	ap (mm)			
Medium to finishing	LP	TNMG 160404-LP					●																				0.10~0.35	0.3~2.0		
		TNMG 160408-LP					●																					0.10~0.40	0.5~2.5	
		TNMG 160412-LP																										0.13~0.45	0.8~3.0	
Medium to finishing	VC	TNMG 160404-VC					●			●	●		●															0.10~0.35	0.30~2.00	
		TNMG 160408-VC						●			●	●		●														0.15~4.00	0.50~3.00	
		TNMG 160412-VC									●	●		●														0.15~4.50	0.50~3.00	
		TNMG 220408-VC									●	●		●														0.15~0.40	0.50~3.00	
		TNMG 220412-VC																										0.15~0.45	0.50~3.00	
Medium to finishing	VP2	TNMG 160404-VP2								●									●	●	●	●	●	●	●	●	●	0.05~0.30	0.10~3.00	
		TNMG 160408-VP2									●									●	●	●	●	●	●	●	●	0.10~0.45	0.50~5.00	
		TNMG 160412-VP2																			●	●	●	●	●	●	●	0.13~0.55	0.80~3.30	
		TNMG 220404-VP2																			●	●	●	●	●	●	●	0.05~0.30	0.80~5.00	
		TNMG 220408-VP2																			●	●	●	●	●	●	●	0.10~0.40	0.80~5.00	
Medium to finishing (Cermert)	VQ	TNMG 110304-VQ																										0.05~0.30	0.50~3.50	
		TNMG 160404-VQ	●	●	●	●	●																					0.05~0.35	0.50~3.50	
		TNMG 160408-VQ	●	●	●	●	●				●																		0.08~0.40	0.80~4.00
		TNMG 220404-VQ																											0.05~0.35	0.50~4.00
Medium	GM	TNMG 160404-GM		●	●			●	●			●																0.05~0.30	0.80~5.00	
		TNMG 160408-GM		●	●			●	●			●																0.10~0.50	1.00~5.00	
		TNMG 160412-GM																										0.13~0.60	1.30~5.00	
		TNMG 220404-GM													●													0.05~0.30	0.90~6.30	
		TNMG 220408-GM								●					●													0.10~0.50	1.00~6.60	
		TNMG 220412-GM													●													0.13~0.60	1.30~6.60	

Cutting edge geometry A38 ~ A43    Recommended chip breaker B04 ~ B11    Code system B18 ~ B19    ● : Stock item

Available tool holders			
Designation	Page	Designation	Page
MTENN	B120	PTGNNR/L	B110
MTFNRR/L	B120	PTTNNR/L	B111
MTGNRR/L	B121	WTENN	B112
MTJNNR/L	B121	WTJNNR/L	B112
PTFNRR/L	B110,140	WTXNNR/L	B112



TN ○ ○

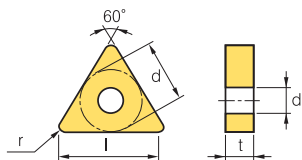

Dimensions(mm)			
Size	d	t	d1
11	6.35	3.18	2.40
16	9.525	4.76	3.81
22	12.7	4.76	5.16

Triangular 60° Negative

Workpiece	Material	Machining types												
		●	○	○	○	○	○	○	○	○	○	○	○	○
Steel	<b>P</b>	●	○	○	○	○	○	○	○	○	○	○	○	○
Stainless steel	<b>M</b>	●	○	○	○	○	○	○	○	○	○	○	○	○
Cast iron	<b>K</b>	○	○	○	○	○	○	○	○	○	○	○	○	○
Non-ferrous metal	<b>N</b>	○	○	○	○	○	○	○	○	○	○	○	○	○
Heat resistant alloy, Titanium alloy	<b>S</b>	○	○	○	○	○	○	○	○	○	○	○	○	○
Hardened steel	<b>H</b>	○	○	○	○	○	○	○	○	○	○	○	○	○

Inserts	Designation	Cermet		Coated	Coated										Uncoated		Cutting Condition												
		CN1500	CN2000	CN2500	CC1500	CC2500	NC3010	NC3215	NC3120	NC3220	NC3225	NC3030	NC5330	NC9020	NC9025	NC6210	NC6215	PC5300	PC5400	PC8105	PC8110	PC8115	PC9030	HO1	HO5	fn (mm/rev)	ap (mm)		
<b>Medium</b> HS 	TNMG 160404-HS													●	●		●	●		●	●			○	○	0.08~0.35	0.50~4.00		
	160408-HS													●	●		●	●		●	●			○	○	0.10~0.40	1.00~4.50		
	160412-HS																●	●		●	●			○	○	0.13~0.55	1.00~4.50		
	220404-HS																●	●						○	○	0.05~0.30	0.90~6.30		
	220408-HS														●	●		●	●		●	●			○	○	0.10~0.40	1.00~6.30	
	220412-HS																●	●						○	○	0.13~0.55	1.00~6.30		
<b>Medium</b> MP 	TNMG 160404-MP								●					●	●				●	●						0.10~0.40	0.4~3.5		
	160408-MP								●					●	●				●	●							0.15~0.45	0.5~4.0	
	160412-MP								●					●	●				●	●							0.15~0.50	0.8~4.5	
	220404-MP								●					●	●				●	●							0.10~0.35	0.4~5.0	
	220408-MP								●					●	●				●	●							0.15~0.45	0.5~5.5	
	220412-MP								●					●	●				●	●							0.15~0.50	0.8~6.0	
	220416-MP								●					●	●				●	●							0.20~0.55	1.0~6.0	
<b>Medium</b> VM 	TNMG 110308-VM																										0.05~0.30	0.80~4.00	
	160404-VM	●	●				●		●	●			●	●	●		●	●									0.05~0.30	0.90~5.00	
	160408-VM	●	●	●			●	●	●	●			●	●	●		●	●				●					0.10~0.50	1.00~5.00	
	160412-VM	●	●				●		●					●	●													0.13~0.60	1.30~5.00
	220404-VM								●					●	●				●	●							0.05~0.30	0.90~6.60	
	220408-VM								●	●				●	●				●	●		●					0.10~0.50	1.00~6.60	
	220412-VM								●					●	●				●	●							0.13~0.60	1.30~6.60	
<b>Medium</b> VP3 	TNMG 160404-VP3																		●	●	●	●		●	●	0.05~0.30	0.10~3.00		
	160408-VP3																		●	●	●	●		●	●	0.10~0.45	0.50~5.00		
<b>Medium (wiper)</b> LW 	TNMG 160408-LW								●																		0.15~0.50	0.70~4.50	
	160412-LW								●																		0.20~0.60	1.00~5.00	

Cutting edge geometry A38 ~ A43    Recommended chip breaker B04 ~ B11    Code system B18 ~ B19    ● : Stock item

Available tool holders			
Designation	Page	Designation	Page
MTENN	B120	PTGNNR/L	B110
MTFNNR/L	B120	PTTNNR/L	B111
MTGNNR/L	B121	WTENN	B112
MTJNNR/L	B121	WTJNNR/L	B112
PTFNNR/L	B110,140	WTXNNR/L	B112

# B Turning Insert (Negative)

## TN ○ ○

### Triangular 60° Negative

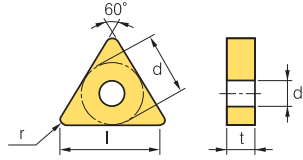

Dimensions(mm)			
Size	d	t	d1
11	6.35	3.18	2.40
16	9.525	3.18~4.76	3.81
22	12.7	4.76	5.16
27	15.875	6.35	6.35
33	19.05	7.94~9.52	7.93

Workpiece	Material										Machining types				
	Steel	Stainless steel	Cast iron	Non-ferrous metal	Heat resistant alloy, Titanium alloy	Hardened steel	P	M	K	N	S	H	Continuous cutting	General cutting	Interrupted cutting
Steel	●	●	●	●	●	●	●	●	●	●	●	●	●	●	●
Stainless steel	●	●	●	●	●	●	●	●	●	●	●	●	●	●	●
Cast iron	●	●	●	●	●	●	●	●	●	●	●	●	●	●	●
Non-ferrous metal	●	●	●	●	●	●	●	●	●	●	●	●	●	●	●
Heat resistant alloy, Titanium alloy	●	●	●	●	●	●	●	●	●	●	●	●	●	●	●
Hardened steel	●	●	●	●	●	●	●	●	●	●	●	●	●	●	●

Inserts	Designation	Cermet		Coated		Coated										Uncoated		Cutting Condition										
		CN1500	CN2000	CN2500	CC1500	CC2500	NC3010	NC3215	NC3120	NC3220	NC3225	NC3030	NC5330	NC9020	NC9025	NC6205	NC6210	NC6215	PC5300	PC5400	PC8105	PC8110	PC9030	H01	H05	fn (mm/rev)	ap (mm)	
Medium to roughing 	TNMG 110308-B25																									0.17~0.40	1.50~3.00	
	160304-B25																										0.17~0.45	2.00~3.50
	160308-B25											●															0.17~0.55	2.00~3.50
	160312-B25																										0.25~0.55	2.00~3.50
	160316-B25																										0.30~0.60	2.50~3.00
	160404-B25		●	●				●	●	●	●	●					●	●									0.17~0.45	2.00~3.50
	160408-B25		●	●				●	●	●	●	●					●	●						●			0.17~0.55	2.00~3.50
	160412-B25			●				●			●	●	●					●									0.25~0.55	2.00~3.50
	160416-B25																	●	●								0.30~0.60	2.50~3.00
	220404-B25							●		●	●	●	●														0.17~0.45	1.50~5.00
	220408-B25							●		●	●	●	●					●									0.17~0.55	2.00~5.00
	220412-B25							●		●	●	●	●					●									0.25~0.55	2.00~5.00
	220416-B25							●		●	●	●	●					●									0.30~0.60	2.00~5.00
	220424-B25																										0.35~0.70	3.00~7.00
	220432-B25																										0.40~0.75	3.50~7.00
	270608-B25												●														0.17~0.55	2.00~5.00
	270612-B25							●		●	●	●	●														0.25~0.55	3.00~7.00
270616-B25																										0.30~0.60	3.00~7.00	
330716-B25							●			●																0.35~0.70	3.00~9.00	
330924-B25																										0.40~0.80	3.00~9.00	
Medium to roughing 	TNMG 160404-GS															●	●						●	●		0.05~0.35	1.00~4.50	
	160408-GS									●							●	●		●				●	●		0.10~0.50	1.00~5.00
	160412-GS																										0.13~0.65	1.00~5.00
	220408-GS																							●			0.10~0.50	1.00~6.80
	220412-GS																										0.15~0.40	1.20~6.00
Roughing 	TNMG 160408-GR									●	●						●	●								0.20~0.50	1.00~7.00	
	160412-GR									●	●						●										0.23~0.54	1.20~8.00
	220408-GR									●	●	●	●				●	●								0.22~0.61	1.10~7.80	
	220412-GR									●	●	●	●				●	●									0.28~0.78	1.20~7.80
	220416-GR									●	●							●									0.31~0.75	1.50~7.80
	270608-GR											●															0.31~0.75	1.50~7.80
	270612-GR										●	●															0.31~0.75	1.50~7.80
	270616-GR											●	●														0.36~1.00	1.60~7.80
	330924-GR												●														0.40~1.00	2.00~9.00

Cutting edge geometry A38 ~ A43    
 Recommended chip breaker B04 ~ B11    
 Code system B18 ~ B19    
 ● : Stock item

Available tool holders			
Designation	Page	Designation	Page
MTENN	B120	PTGNR/L	B110
MTFNR/L	B120	PTTNR/L	B111
MTGNR/L	B121	WTENN	B112
MTJNR/L	B121	WTJNR/L	B112
PTFNR/L	B110,140	WTXNR/L	B112





# TN ○ ○

## Triangular 60° Negative

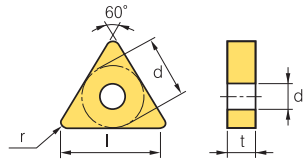

Dimensions(mm)			
Size	d	t	d1
16	9.525	4.76	3.81
22	12.7	4.76	5.16
27	15.875	6.35	6.35
33	19.05	7.94~9.52	7.93

Workpiece	Machining types																								
	P	M	K	N	S	H	NC3010	NC3215	NC3120	NC3220	NC3225	NC3030	NC5330	NC9020	NC9025	NC6205	NC6210	NC6215	PC5300	PC5400	PC8105	PC8110	PC8115	HD1	H05
Steel	●	●	●	●	●	●	●	●	●	●	●	●	●	●	●	●	●	●	●	●	●	●	●	●	●
Stainless steel	●	●	●	●	●	●	●	●	●	●	●	●	●	●	●	●	●	●	●	●	●	●	●	●	●
Cast iron	●	●	●	●	●	●	●	●	●	●	●	●	●	●	●	●	●	●	●	●	●	●	●	●	●
Non-ferrous metal	●	●	●	●	●	●	●	●	●	●	●	●	●	●	●	●	●	●	●	●	●	●	●	●	●
Heat resistant alloy, Titanium alloy	●	●	●	●	●	●	●	●	●	●	●	●	●	●	●	●	●	●	●	●	●	●	●	●	●
Hardened steel	●	●	●	●	●	●	●	●	●	●	●	●	●	●	●	●	●	●	●	●	●	●	●	●	●

Inserts	Designation	Cermet		Coated		Coated											Uncoated		Cutting Condition										
		CN1500	CN2000	CN2500	CC1500	CC2500	NC3010	NC3215	NC3120	NC3220	NC3225	NC3030	NC5330	NC9020	NC9025	NC6205	NC6210	NC6215	PC5300	PC5400	PC8105	PC8110	PC8115	HD1	H05	fn (mm/rev)	ap (mm)		
Roughing 	TNMG 160408-HR					●																				0.20~0.50	1.00~7.00		
	160412-HR						●																				0.25~0.60	1.30~7.00	
	220404-HR																										0.20~0.45	1.00~7.50	
	220408-HR																										0.20~0.50	1.00~8.00	
	220412-HR																										0.25~0.60	1.30~8.00	
	220416-HR																										0.32~0.70	1.80~8.00	
	270608-HR																										0.35~0.50	1.80~13.00	
	270612-HR																											0.35~0.70	2.30~13.00
	270632-HR																											0.40~0.90	3.00~13.00
	330716-HR																											0.40~0.70	3.00~14.00
330924-HR																											0.45~0.90	3.30~16.00	
Roughing 	TNMG 160404-VK																										0.15~0.50	0.80~5.00	
	160408-VK																											0.20~0.50	1.00~5.50
	160416-VK																											0.15~0.50	1.50~5.50
	220408-VK																											0.15~0.55	1.00~5.50
	220412-VK																											0.25~0.60	1.50~6.00
	220416-VK																											0.25~0.60	2.00~6.00
Roughing 	TNMG 160408-VR																										0.25~0.55	1.2~7.0	
	160412-VR																											0.35~0.65	1.7~7.0
	160416-VR																											0.35~0.70	2.0~10.0
	220408-VR																											0.35~0.70	2.0~10.0
	220412-VR																											0.35~0.70	2.0~10.0
	220416-VR																											0.35~0.75	2.2~10.0
Medium 	TNMM 160412-GM																										0.13~0.60	1.30~5.00	
	220408-GM																											0.10~0.50	1.00~6.60
	220412-GM																											0.13~0.60	1.30~6.60
	220416-GM																											0.15~0.65	1.50~7.00
Roughing 	TNMM 220408-GR																										0.22~0.61	1.10~7.80	
	220412-GR																											0.28~0.78	1.20~7.80
	220416-GR																											0.31~0.75	1.50~7.80

Cutting edge geometry **A38 ~ A43**
 Recommended chip breaker **B04 ~ B11**
 Code system **B18 ~ B19**
● : Stock item

Available tool holders			
Designation	Page	Designation	Page
MTENN	B120	PTGNNR/L	B110
MTFNNR/L	B120	PTTNNR/L	B111
MTGNNR/L	B121	WTENN	B112
MTJNNR/L	B121	WTJNNR/L	B112
PTFNNR/L	B110,140	WTXNNR/L	B112



# B Turning Insert (Negative)

## TN ○ ○

Triangular 60° Negative

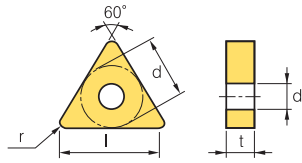

Dimensions(mm)			
Size	d	t	d1
16	9.525	4.76	3.81
22	12.7	4.76	5.16
27	15.875	6.35	6.35
33	19.05	9.52	7.93

Workpiece	Machining types											
	P	M	K	N	S	H						
Steel	●	●	●	●	●	●	●	●	●	●	●	●
Stainless steel	●	●	●	●	●	●	●	●	●	●	●	●
Cast iron	●	●	●	●	●	●	●	●	●	●	●	●
Non-ferrous metal	●	●	●	●	●	●	●	●	●	●	●	●
Heat resistant alloy, Titanium alloy	●	●	●	●	●	●	●	●	●	●	●	●
Hardened steel	●	●	●	●	●	●	●	●	●	●	●	●

● Continuous cutting  
● General cutting  
● Interrupted cutting

Inserts	Designation	Cermet		Coated		Coated										Uncoated		Cutting Condition										
		CN1500	CN2000	CN2500	CC1500	CC2500	NC3010	NC3215	NC3120	NC3220	NC3225	NC3030	NC5330	NC9020	NC9025	NC6205	NC6210	NC6215	PC5300	PC5400	PC8105	PC8110	PC8115	H01	H05	fn (mm/rev)	ap (mm)	
Heavy 	TNMM 160408-GH										●															0.20~0.50	1.00~7.00	
	220408-GH										●																0.25~0.60	1.30~7.00
	220412-GH								●		●																0.20~0.50	1.00~8.00
	220416-GH										●																0.25~0.60	1.30~8.00
	270616-GH											●															0.32~0.70	1.80~8.00
	270624-GH																										0.35~0.50	1.80~13.00
	330924-GH																										0.35~0.70	2.30~13.00
Medium to roughing 	TNMN 160408		●																							0.10~0.30	1.00~4.00	
	220408		●																								0.15~0.40	1.50~5.00
	220412																										0.20~0.50	1.50~5.00
Medium (Sharft) 	TNMX 160404R-SH																									0.15~0.30	0.50~4.00	
	160408R-SH																										0.15~0.45	1.00~4.0
	160404L-SH																										0.15~0.30	0.50~4.00
	160408L-SH																										0.15~0.45	1.00~4.0
Medium to roughing 	TNMX 160402R		●	●																							0.10~0.30	0.50~3.00
	160404R		●					●	●		●	●															0.12~0.30	1.00~3.50
	160408R		●						●		●																0.15~0.35	1.30~3.40
	220404R																										0.12~0.30	1.00~5.00
	220408R																										0.15~0.35	1.30~5.00
	160404L		●						●	●		●															0.12~0.30	1.00~3.50
	160408L									●	●		●														0.15~0.35	1.30~3.40

Cutting edge geometry A38 ~ A43    
 Recommended chip breaker B04 ~ B11    
 Code system B18 ~ B19    
 ● : Stock item

Available tool holders			
Designation	Page	Designation	Page
MTENN	B120	PTGNNR/L	B110
MTFNRR/L	B120	PTTNNR/L	B111
MTGNRR/L	B121	WTENN	B112
MTJNNR/L	B121	WTJNNR/L	B112
PTFNRR/L	B110,140	WTXNNR/L	B112





# B Turning Insert (Negative)

## VN○○○

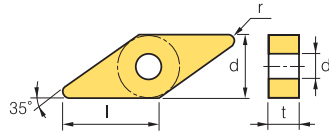

Dimensions(mm)			
Size	d	t	d1
16	9.525	4.76	3.81
22	12.7	4.76	5.16

Rhombic **35° Negative**

Workpiece	Material										Machining types					
	Steel	Stainless steel	Cast iron	Non-ferrous metal	Heat resistant alloy, Titanium alloy	Hardened steel	P	M	K	N	S	H	●	⊙	⊛	
Steel							●	●	●	●	●	●	●	●	●	●
Stainless steel		●					●	●	●	●	●	●	●	●	●	●
Cast iron			●				●	●	●	●	●	●	●	●	●	●
Non-ferrous metal				●			●	●	●	●	●	●	●	●	●	●
Heat resistant alloy, Titanium alloy					●		●	●	●	●	●	●	●	●	●	●
Hardened steel						●	●	●	●	●	●	●	●	●	●	●

Inserts	Designation	Cermets		Coated		Coated										Uncoated		Cutting Condition											
		CN1500	CN2000	CN2500	CC1500	CC2500	NC3010	NC3215	NC3120	NC3220	NC3225	NC3030	NC5330	NC9020	NC9025	NC6210	NC6215	PC5300	PC5400	PC8105	PC8110	PC8115	PC9030	H01	H05	fn (mm/rev)	ap (mm)		
Medium to finishing (Cermets)	VQ	VNMG 160404-VQ	●	●	●	●					●																0.10~0.40	0.50~3.50	
		160408-VQ	●	●	●	●					●																	0.12~0.45	0.50~3.50
Medium	GM	VNMG 160404-GM	●	●	●						●																0.08~0.45	0.50~3.50	
		160408-GM	●	●	●						●																	0.10~0.50	1.00~4.00
Medium	HS	VNMG 160404-HS													●			●	●	●	●	●					0.08~0.35	0.50~4.00	
		160408-HS																●	●	●	●	●					0.10~0.40	1.00~4.50	
Medium	MP	VNMG 160404-MP						●			●	●								●	●						0.10~0.40	0.4~3.5	
		160408-MP						●			●	●								●	●						0.15~0.45	0.5~4.0	
		160412-MP																										0.15~0.50	0.8~4.5
Medium	VP3	VNMG 160404-VP3																		●	●	●	●	●	●	●	●	0.05~0.30	0.10~3.00
		160408-VP3																		●	●	●	●	●	●	●	●	0.10~0.45	0.50~5.00
Medium	VM	VNMG 160404-VM	●	●			●			●	●	●				●		●	●									0.08~0.45	0.50~3.50
		160408-VM	●	●			●		●	●	●	●				●		●	●								0.10~0.50	1.00~4.00	
		160412-VM								●																		0.20~0.50	1.50~4.00
		220404-VM																										0.08~0.45	1.00~5.00
Medium to roughing	HR	VNMG 160408-HR																										0.10~0.50	1.00~4.00
Roughing	VK	VNMG 160412-VK														●												0.15~0.50	0.80~4.00
		160404-B25	●	●	●																								

Cutting edge geometry A38 ~ A43  
 Recommended chip breaker B04 ~ B11  
 Code system B18 ~ B19  
 ● : Stock item

Available tool holders			
Designation	Page	Designation	Page
MVJNR/L	B121	MVVNN	B122
MVQNR/L	B122	MVUNR/L	B143



WN

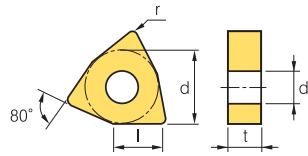

Dimensions(mm)			
Size	d	t	d1
06	9.525	4.76	3.81
08	12.7	4.76	5.16

## Trigon **80° Negative**

Workpiece	Steel	P																			Machining types
	Stainless steel	M																			
Cast iron	K																			● Continuous cutting ● General cutting ✱ Interrupted cutting	
Non-ferrous metal	N																				
Heat resistant alloy, Titanium alloy	S																				
Hardened steel	H																				

Inserts	Designation	Cermets		Coated		Coated											Uncoated		Cutting Condition										
		CN1500	CN2000	CN2500	CC1500	CC2500	NC3010	NC3215	NC3120	NC3220	NC3225	NC3030	NC5330	NC9020	NC9025	NC6205	NC6210	NC6215	PC5300	PC5400	PC8105	PC8110	PC9030	H01	H05	fn (mm/rev)	ap (mm)		
Roughing		WNMA 060404																									0.10~0.30	0.50~3.00	
		060408																										0.10~0.30	0.50~3.00
		060412																										0.10~0.40	1.00~3.00
		080404																										0.15~0.60	1.00~5.00
		080408																										0.15~0.60	1.00~6.00
		080412																										0.15~0.70	1.50~6.00
		080416																										0.15~0.70	1.50~6.00
Finishing		WNMG 080404-VB						●	●		●	●															0.10~0.35	0.30~1.50	
		080408-VB								●	●	●	●															0.15~0.45	0.50~2.00
Finishing		WNMG 060404-VF		●				●					●														0.07~0.30	0.50~1.50	
		060408-VF						●			●																	0.10~0.40	0.50~1.50
		080404-VF						●		●			●															0.07~0.30	0.50~1.50
		080408-VF								●			●															0.10~0.40	0.50~1.50
		080412-VF																										0.20~0.50	0.50~1.50
Finishing (Cermets)		WNMG 060404-VG																									0.07~0.30	0.50~1.50	
		060408-VG																									0.10~0.40	0.50~1.50	
		080404-VG		●	●																							0.07~0.30	0.50~1.50
		080408-VG		●																								0.10~0.40	0.50~1.50
Finishing (Mild steel)		WNMG 060404-VL																									0.05~0.25	0.20~1.50	
		080404-VL									●																0.05~0.25	0.10~1.00	
		080408-VL						●			●		●														0.10~0.35	0.20~1.50	
Finishing (wiper)		WNMG 080404-VW																									0.10~0.30	0.50~3.00	
		080408-VW																									0.15~0.50	0.50~4.00	
Medium to finishing		WNMG 060404-HA																				●	●	●			0.05~0.30	0.10~3.00	
		060408-HA																						●	●		0.10~0.40	0.80~3.50	
		080404-HA									●			●									●	●	●			0.05~0.30	0.80~3.50
		080408-HA													●								●	●	●			0.10~0.40	0.80~3.50
		080412-HA																						●	●	●			0.13~0.55

Cutting edge geometry A38 ~ A43  
 Recommended chip breaker B04 ~ B11  
 Code system B18 ~ B19  
 ● : Stock item

Available tool holders			
Designation	Page	Designation	Page
MWLNRL	B122	WWLNRL	B113
PWLNRL	B140		





# B Turning Insert (Negative)

WN ○○

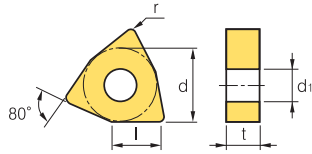

Dimensions(mm)			
Size	d	t	d1
06	9.525	4.76	3.81
08	12.7	4.76	5.16

## Trigon 80° Negative

Workpiece	Steel	P	●	●	●	●	●	●	●	●	●	●	●	●	●	●	●	Machining types		
	Stainless steel	M	●	●	●	●	●	●	●	●	●	●	●	●	●	●	●	●	●	●
Cast iron	K	●	●	●	●	●	●	●	●	●	●	●	●	●	●	●	●	●	●	●
Non-ferrous metal	N	●	●	●	●	●	●	●	●	●	●	●	●	●	●	●	●	●	●	●
Heat resistant alloy, Titanium alloy	S	●	●	●	●	●	●	●	●	●	●	●	●	●	●	●	●	●	●	●
Hardened steel	H	●	●	●	●	●	●	●	●	●	●	●	●	●	●	●	●	●	●	●

● Continuous cutting  
 ● General cutting  
 ✚ Interrupted cutting

Inserts	Designation	Cermet		Coated		Coated											Uncoated		Cutting Condition										
		CN1500	CN2000	CN2500	CC1500	CC2500	NC3010	NC3215	NC3120	NC3220	NC3225	NC3030	NC5330	NC9020	NC9025	NC6210	NC6215	P05300	P05400	PC8105	PC8110	PC8115	PC9030	H01	H05	fn (mm/rev)	ap (mm)		
Medium to finishing	HC	WNMG 060404-HC																										0.05~0.30	0.80~4.00
		080404-HC																										0.05~0.30	0.80~4.00
		080408-HC																										0.08~0.40	0.80~4.00
Medium to finishing	LP	WNMG 080404-LP																										0.10~0.35	0.3~2.0
		080408-LP																										0.10~0.40	0.5~2.5
		080412-LP																										0.13~0.45	0.8~3.0
Medium to finishing	VC	WNMG 080404-VC																										0.15~0.40	0.15~4.00
		080408-VC																										0.15~0.45	0.15~4.50
		080412-VC																										0.15~0.45	0.15~4.50
Medium to finishing	VP2	WNMG 080404-VP2																										0.10~0.45	0.50~5.00
		080408-VP2																										0.12~0.50	0.50~5.00
		080412-VP2																										0.05~0.30	0.10~3.00
Medium to finishing (Cermel)	VQ	WNMG 060404-VQ																										0.05~0.30	0.50~4.00
		060408-VQ																										0.08~0.30	0.80~4.00
		080404-VQ																										0.05~0.30	0.50~4.00
		080408-VQ																										0.08~0.40	0.80~4.00
		080412-VQ																										0.10~0.35	0.80~3.50
Medium	GM	WNMG 080404-GM																										0.05~0.30	0.90~5.00
		080408-GM																										0.10~0.50	1.00~5.00
		080412-GM																										0.18~0.60	0.30~5.00
Medium	HS	WNMG 060404-HS																										0.05~0.20	1.00~2.50
		060408-HS																										0.10~0.20	1.00~2.50
		060412-HS																										0.10~0.30	1.00~3.50
		080404-HS																										0.05~0.30	1.00~4.50
		080408-HS																										0.10~0.40	1.00~4.50
		080412-HS																										0.13~0.55	1.00~4.50

Cutting edge geometry A38 ~ A43  
 Recommended chip breaker B04 ~ B11  
 Code system B18 ~ B19  
 ● : Stock item

Available tool holders			
Designation	Page	Designation	Page
MWLNRL	B122	WWLNRL	B113
PWLNRL	B140		



# WN○○○

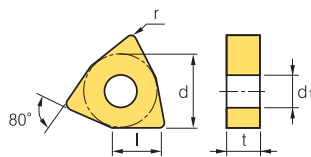

Dimensions(mm)			
Size	d	t	d1
06	9.525	4.76	3.81
08	12.7	4.76	5.16

## Trigon **80° Negative**

Workpiece		P	M	K	N	S	H	Machining types
	Steel		●	●	●	●	●	
Stainless steel		●	●	●				
Cast iron		●	●	●				
Non-ferrous metal					●	●	●	
Heat resistant alloy, Titanium alloy						●	●	
Hardened steel							●	

Inserts	Designation	Cermet		Coated											Uncoated		Cutting Condition											
		CN1500	CN2000	CN2500	CC1500	CC2500	NC3010	NC3215	NC3120	NC3220	NC3225	NC3030	NC5330	NC9020	NC9025	NC6210	NC6215	PC5300	PC5400	PC8105	PC8110	PC8115	PC9030	HD1	HD5	fn (mm/rev)	ap (mm)	
<b>Medium</b> 	WNMG 080404-MP						●										●			●	●	●				0.10~0.40	0.4~4.0	
	080408-MP						●										●			●	●	●				0.15~0.45	0.5~4.5	
	080412-MP						●										●			●	●	●				0.15~0.50	0.8~5.0	
	080416-MP																										0.18~0.55	0.1~5.0
<b>Medium</b> 	WNMG 060402-VM																									0.05~0.30	0.90~3.50	
	060404-VM						●			●							●	●								0.10~0.45	1.00~3.50	
	060408-VM						●		●	●	●	●	●			●	●	●								0.10~0.50	1.00~4.00	
	060412-VM																										0.13~0.60	1.30~4.00
	080404-VM								●	●						●	●	●								0.05~0.30	0.90~5.00	
	080408-VM						●		●	●	●	●	●			●	●	●	●		●			●		0.10~0.50	1.00~5.00	
<b>Medium</b> 	WNMG 080404-VP3																●	●	●	●	●		●	●	0.10~0.45	0.50~5.00		
	080408-VP3																●	●	●	●	●		●	●	0.12~0.50	0.50~5.00		
	080412-VP3																●	●	●	●	●		●	●	0.05~0.30	0.10~3.00		
<b>Medium (wiper)</b> 	WNMG 060408-LW						●																		0.15~0.60	0.50~3.50		
	060412-LW																									0.20~0.70	0.80~3.50	
	080408-LW						●						●		●										0.15~0.60	1.00~5.00		
	080412-LW						●									●										0.20~0.70	1.00~6.00	
<b>Medium to roughing</b> 	WNMG 080404-B25						●			●							●								0.17~0.45	1.00~5.00		
	080408-B25						●		●	●	●	●				●	●								0.23~0.60	1.50~5.00		
	080412-B25						●			●						●									0.25~0.60	2.00~5.00		
<b>Medium to roughing</b> 	WNMG 060404-GS																				●				0.05~0.25	0.10~3.00		
	060408-GS																				●		●		0.10~0.50	1.00~4.00		
	060412-GS																								0.10~0.50	1.00~4.00		
	080404-GS												●	●			●			●	●	●			0.05~0.25	0.10~3.00		
	080408-GS								●					●	●		●			●	●	●			0.10~0.50	1.00~5.00		
	080412-GS																								0.13~0.65	1.00~5.00		

Cutting edge geometry A38 ~ A43

Recommended chip breaker B04 ~ B11

Code system B18 ~ B19

● : Stock item

Available tool holders			
Designation	Page	Designation	Page
MWLN/L	B122	WWLN/L	B113
PWLN/L	B140		

# B Turning Insert (Negative)

## WN○○○

### Trigon 80° Negative

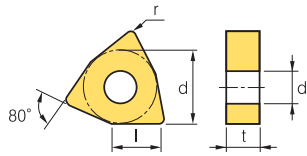

Dimensions(mm)			
Size	d	t	d1
06	9.525	4.76	3.81
08	12.7	4.76	5.16
10	15.875	6.35	6.35
13	19.05	6.35	7.93

Workpiece	Material												Machining types				
	Steel	Stainless steel	Cast iron	Non-ferrous metal	Heat resistant alloy, Titanium alloy	Hardened steel	P	M	K	N	S	H	●	●	✦	●	
Steel							●	●	●	●	●	●	●	●	●	●	●
Stainless steel		●	●	●	●	●	●	●	●	●	●	●	●	●	●	●	●
Cast iron			●	●	●	●	●	●	●	●	●	●	●	●	●	●	●
Non-ferrous metal				●	●	●	●	●	●	●	●	●	●	●	●	●	●
Heat resistant alloy, Titanium alloy					●	●	●	●	●	●	●	●	●	●	●	●	●
Hardened steel							●	●	●	●	●	●	●	●	●	●	●

Inserts	Designation	Cermets		Coated		Coated										Uncoated		Cutting Condition										
		CN1500	CN2000	CN2500	CC1500	CC2500	NC3010	NC3215	NC3120	NC3220	NC3225	NC3030	NC5330	NC9020	NC9025	NC6205	NC6210	NC6215	PC5300	PC5400	PC8105	PC8110	PC8115	H01	H05	fn (mm/rev)	ap (mm)	
Roughing	GR	WNMG 080404-GR																									0.15~0.50	0.08~6.00
		080408-GR						●	●	●	●	●	●	●	●	●	●	●	●	●	●	●	●	●	●	●	0.20~0.50	1.00~7.00
		080412-GR						●	●	●	●	●	●	●	●	●	●	●	●	●	●	●	●	●	●	●	0.25~0.50	1.30~7.00
		080416-GR						●																		●	0.25~0.60	1.80~6.00
Roughing	HR	WNMG 060408-HR																									0.20~0.40	1.00~5.50
		060412-HR																									0.25~0.50	1.10~5.50
		080408-HR						●				●															0.20~0.50	1.00~7.00
		080412-HR						●				●															0.25~0.65	1.30~7.00
Roughing	VK	WNMG 080404-VK																									0.15~5.00	0.08~6.00
		080408-VK																									0.20~5.00	1.00~7.00
		080412-VK																									0.25~5.00	1.30~7.00
		080416-VK																									0.25~6.00	1.89~6.00
Roughing	VR	WNMG 080408-VR																									0.25~0.55	1.2~7.0
		080412-VR																									0.30~0.60	1.5~7.0
Medium to roughing	B25	WNMM 100608-B25																									0.30~0.80	3.00~8.00
		130612-B25																									0.40~0.90	4.00~10.00
Medium (Shaft)	SH	WNMX 080404R-SH																									0.15~0.30	1.00~4.00
		080408R-SH																									0.15~0.50	1.50~5.00
		080404L-SH																									0.15~0.30	1.00~4.00
		080408L-SH																									0.15~0.50	1.50~5.00

Cutting edge geometry A38 ~ A43  
 Recommended chip breaker B04 ~ B11  
 Code system B18 ~ B19  
 ● : Stock item

Available tool holders			
Designation	Page	Designation	Page
MWLNLR/L	B122	WWLNLR/L	B113
PWLNLR/L	B140		





**Rhombic 80° Positive**  
Relief Angle : 7°

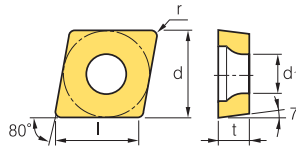

Dimensions(mm)			
Size	d	t	d1
03	3.5	1.39	1.9
04	4.3	1.79	2.3
06	6.35	2.38	2.8
09	9.525	3.97	4.4

Workpiece	Machining types															
	P	M	K	N	S	H	●	⊖	⊕	⊘	⊙	⊚	⊛	⊜	⊝	⊞
Steel	●	●	●	●	●	●	●	●	●	●	●	●	●	●	●	●
Stainless steel	●	●	●	●	●	●	●	●	●	●	●	●	●	●	●	●
Cast iron	●	●	●	●	●	●	●	●	●	●	●	●	●	●	●	●
Non-ferrous metal	●	●	●	●	●	●	●	●	●	●	●	●	●	●	●	●
Heat resistant alloy, Titanium alloy	●	●	●	●	●	●	●	●	●	●	●	●	●	●	●	●
Hardened steel	●	●	●	●	●	●	●	●	●	●	●	●	●	●	●	●

Inserts	Designation	Cermet		Coated		Coated											Uncoated		Cutting Condition											
		CN1500	CN2000	CN2500	CC1500	CC2500	NC3010	NC3215	NC3120	NC3220	NC3225	NC3030	NC5330	NC9020	NC9025	NC6205	NC6210	NC6215	PC5300	PC5400	PC8105	PC8110	PC8115	H01	H05	fn (mm/rev)	ap (mm)			
Finishing	CCET	0301005R																									0.01~0.05	0.10~0.30		
		030101R																										0.01~0.05	0.10~0.30	
		030102R																										0.01~0.05	0.10~0.30	
		030104R																										0.01~0.05	0.10~0.30	
		0401005R																										0.01~0.10	0.10~0.50	
		040101R																										0.01~0.10	0.10~0.50	
		040102R																										0.01~0.10	0.10~0.50	
		040104R																										0.01~0.10	0.10~0.50	
		0301005L																											0.01~0.05	0.10~0.30
		030101L																											0.01~0.05	0.10~0.30
		030102L		●																					●	●			0.01~0.05	0.10~0.30
		030104L																											0.01~0.05	0.10~0.30
		0401005L																											0.01~0.10	0.10~0.50
		040101L																											0.01~0.10	0.10~0.50
040102L		●																					●	●			0.01~0.10	0.10~0.50		
040104L																											0.01~0.10	0.10~0.50		
Finishing (High precision)	CCET	0602005MFR-KF																									0.01~0.06	0.04~1.30		
		060201MFR-KF																					●					0.02~0.08	0.05~1.50	
		060202MFR-KF																					●					0.03~0.11	0.06~1.70	
		09T3005MFR-KF																										0.02~0.08	0.05~1.50	
		09T301MFR-KF																						●					0.03~0.11	0.06~1.70
		09T302MFR-KF																						●					0.04~0.15	0.08~2.00
		0602005MFL-KF																										0.01~0.06	0.04~1.30	
		060201MFL-KF																											0.02~0.08	0.05~1.50
		060202MFL-KF																											0.03~0.11	0.06~1.70
		09T3005MFL-KF																											0.02~0.08	0.05~1.50
		09T301MFL-KF																											0.03~0.11	0.06~1.70
09T302MFL-KF																											0.04~0.15	0.08~2.00		
Medium to finishing (High precision)	CCET	0602005MFR-KM																									0.01~0.06	0.04~1.30		
		060201MFR-KM																						●				0.02~0.08	0.05~1.50	
		060202MFR-KM																						●				0.03~0.11	0.06~1.70	
		09T3005MFR-KM																										0.02~0.08	0.05~1.50	
		09T301MFR-KM																										0.03~0.11	0.06~1.70	
		09T302MFR-KM																										0.04~0.15	0.08~2.00	
		0602005MFL-KM																										0.01~0.06	0.04~1.30	
		060201MFL-KM																											0.02~0.08	0.05~1.50
		060202MFL-KM																											0.03~0.11	0.06~1.70
		09T3005MFL-KM																											0.02~0.08	0.05~1.50
		09T301MFL-KM																											0.03~0.11	0.06~1.70
09T302MFL-KM																											0.04~0.15	0.08~2.00		

🔄 Cutting edge geometry A38 ~ A43
🔄 Recommended chip breaker B04 ~ B11
🔄 Code system B18 ~ B19
● : Stock item

Available tool holders			
Designation	Page	Designation	Page
SCACR/L	B123,177	SCLCR/L	B123,144,150,151,177



# B Turning Insert (Positive)



**Rhombic 80° Positive**  
Relief Angle : 7°

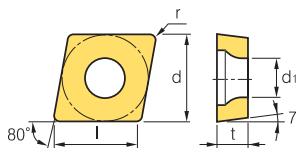

Dimensions(mm)			
Size	d	t	d1
06	6.35	2.38	2.8
09	9.525	3.97	4.4
12	12.7	4.76	5.5

Workpiece	Machining types											
	P	M	K	N	S	H	●	●	●	●	●	●
Steel	●	●	●	●	●	●	●	●	●	●	●	●
Stainless steel	●	●	●	●	●	●	●	●	●	●	●	●
Cast iron	●	●	●	●	●	●	●	●	●	●	●	●
Non-ferrous metal	●	●	●	●	●	●	●	●	●	●	●	●
Heat resistant alloy, Titanium alloy	●	●	●	●	●	●	●	●	●	●	●	●
Hardened steel	●	●	●	●	●	●	●	●	●	●	●	●

Inserts	Designation	Cermets		Coated		Coated										Uncoated		Cutting Condition									
		CN1500	CN2000	CN2500	CC1500	CC2500	NC3010	NC3215	NC3120	NC3220	NC3225	NC3030	NC5330	NC9020	NC9025	NC6210	NC6215	PC5300	PC5400	PC8105	PC8110	PC8115	PC9030	H01	H05	fn (mm/rev)	ap (mm)
Finishing 	CCGT	060202-C05	●	●	●	●	●	●	●	●	●	●	●	●	●	●	●	●	●	●	●	●	●	●	●	0.06~0.11	0.06~1.70
		060204-C05	●	●	●	●	●	●	●	●	●	●	●	●	●	●	●	●	●	●	●	●	●	●	●	0.08~0.17	0.10~1.70
		09T304-C05	●	●	●	●	●	●	●	●	●	●	●	●	●	●	●	●	●	●	●	●	●	●	●	0.11~0.23	0.10~2.00
		09T308-C05	●	●	●	●	●	●	●	●	●	●	●	●	●	●	●	●	●	●	●	●	●	●	●	0.08~0.30	0.20~2.00
		120404-C05	●	●	●	●	●	●	●	●	●	●	●	●	●	●	●	●	●	●	●	●	●	●	●	0.07~0.27	0.10~2.70
		120408-C05	●	●	●	●	●	●	●	●	●	●	●	●	●	●	●	●	●	●	●	●	●	●	●	0.08~0.30	0.20~2.70
Finishing 	CCGT	060202-HFP	●	●	●	●	●	●	●	●	●	●	●	●	●	●	●	●	●	●	●	●	●	●	●	0.03~0.06	0.06~1.20
		060204-HFP	●	●	●	●	●	●	●	●	●	●	●	●	●	●	●	●	●	●	●	●	●	●	●	0.05~0.12	0.10~1.20
		060208-HFP	●	●	●	●	●	●	●	●	●	●	●	●	●	●	●	●	●	●	●	●	●	●	●	0.05~0.12	0.12~1.40
		09T302-HFP	●	●	●	●	●	●	●	●	●	●	●	●	●	●	●	●	●	●	●	●	●	●	●	0.04~0.16	0.08~1.50
		09T304-HFP	●	●	●	●	●	●	●	●	●	●	●	●	●	●	●	●	●	●	●	●	●	●	●	0.06~0.18	0.10~1.50
		09T308-HFP	●	●	●	●	●	●	●	●	●	●	●	●	●	●	●	●	●	●	●	●	●	●	●	0.08~0.25	0.20~1.50
		120404-HFP	●	●	●	●	●	●	●	●	●	●	●	●	●	●	●	●	●	●	●	●	●	●	●	0.06~0.20	0.10~2.00
		120408-HFP	●	●	●	●	●	●	●	●	●	●	●	●	●	●	●	●	●	●	●	●	●	●	●	0.10~0.25	0.20~2.00
Finishing 	CCGT	0602003R-KF	●	●	●	●	●	●	●	●	●	●	●	●	●	●	●	●	●	●	●	●	●	●	●	0.01~0.06	0.04~1.30
		060201R-KF	●	●	●	●	●	●	●	●	●	●	●	●	●	●	●	●	●	●	●	●	●	●	●	0.02~0.08	0.05~1.50
		060202R-KF	●	●	●	●	●	●	●	●	●	●	●	●	●	●	●	●	●	●	●	●	●	●	●	0.03~0.11	0.06~1.70
		09T3003R-KF	●	●	●	●	●	●	●	●	●	●	●	●	●	●	●	●	●	●	●	●	●	●	●	0.02~0.08	0.05~1.50
		09T301R-KF	●	●	●	●	●	●	●	●	●	●	●	●	●	●	●	●	●	●	●	●	●	●	●	0.03~0.11	0.06~1.70
		09T302R-KF	●	●	●	●	●	●	●	●	●	●	●	●	●	●	●	●	●	●	●	●	●	●	●	0.04~0.15	0.08~2.00
		0602003L-KF	●	●	●	●	●	●	●	●	●	●	●	●	●	●	●	●	●	●	●	●	●	●	●	0.01~0.06	0.04~1.30
		060201L-KF	●	●	●	●	●	●	●	●	●	●	●	●	●	●	●	●	●	●	●	●	●	●	●	0.02~0.08	0.05~1.50
		060202L-KF	●	●	●	●	●	●	●	●	●	●	●	●	●	●	●	●	●	●	●	●	●	●	●	0.03~0.11	0.06~1.70
		09T3003L-KF	●	●	●	●	●	●	●	●	●	●	●	●	●	●	●	●	●	●	●	●	●	●	●	0.02~0.08	0.05~1.50
		09T301L-KF	●	●	●	●	●	●	●	●	●	●	●	●	●	●	●	●	●	●	●	●	●	●	●	0.03~0.11	0.06~1.70
		09T302L-KF	●	●	●	●	●	●	●	●	●	●	●	●	●	●	●	●	●	●	●	●	●	●	●	0.04~0.15	0.08~2.00
Finishing 	CCGT	060201-VP1	●	●	●	●	●	●	●	●	●	●	●	●	●	●	●	●	●	●	●	●	●	●	●	0.05~0.06	0.06~1.00
		060202-VP1	●	●	●	●	●	●	●	●	●	●	●	●	●	●	●	●	●	●	●	●	●	●	●	0.03~0.10	0.08~1.50
		060204-VP1	●	●	●	●	●	●	●	●	●	●	●	●	●	●	●	●	●	●	●	●	●	●	●	0.05~0.12	0.10~1.50
		09T301-VP1	●	●	●	●	●	●	●	●	●	●	●	●	●	●	●	●	●	●	●	●	●	●	●	0.03~0.13	0.06~1.00
		09T302-VP1	●	●	●	●	●	●	●	●	●	●	●	●	●	●	●	●	●	●	●	●	●	●	●	0.04~0.15	0.08~1.50
		09T304-VP1	●	●	●	●	●	●	●	●	●	●	●	●	●	●	●	●	●	●	●	●	●	●	●	0.06~0.20	0.10~1.50

Cutting edge geometry A38 ~ A43    
 Recommended chip breaker B04 ~ B11    
 Code system B18 ~ B19    
 ● : Stock item

Available tool holders			
Designation	Page	Designation	Page
SCACR/L	B123,177	SCLCR/L	B123,144,151,177









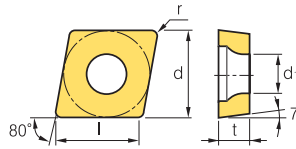

**Rhombic 80° Positive**  
Relief Angle : 7°



Dimensions(mm)			
Size	d	t	d1
06	6.35	2.38	2.8
09	9.525	3.97	4.4
12	12.7	4.76	5.5

Workpiece	Material Compatibility																Machining types		
	Steel	Stainless steel	Cast iron	Non-ferrous metal	Heat resistant alloy, Titanium alloy	Hardened steel	P	M	K	N	S	H	●	⊙	⊘	⊚	⊛	⊜	
Steel	●	●	●	●	●	●	●	●	●	●	●	●	●	●	●	●	●	●	●
Stainless steel	●	●	●	●	●	●	●	●	●	●	●	●	●	●	●	●	●	●	●
Cast iron	●	●	●	●	●	●	●	●	●	●	●	●	●	●	●	●	●	●	●
Non-ferrous metal	●	●	●	●	●	●	●	●	●	●	●	●	●	●	●	●	●	●	●
Heat resistant alloy, Titanium alloy	●	●	●	●	●	●	●	●	●	●	●	●	●	●	●	●	●	●	●
Hardened steel	●	●	●	●	●	●	●	●	●	●	●	●	●	●	●	●	●	●	●

Inserts	Designation	Cermet		Coated		Coated										Uncoated		Cutting Condition												
		CN1500	CN2000	CN2500	CC1500	CC2500	NC3010	NC3215	NC3120	NC3220	NC3225	NC3030	NC5330	NC9020	NC9025	NC6205	NC6210	NC6215	PC5300	PC5400	PC8105	PC8110	PC9030	H01	H05	fn (mm/rev)	ap (mm)			
Finishing (High precision)	 VP1 <i>New</i>	CCGT 060201MFN-VP1																									0.03~0.06	0.06~1.00		
		CCGT 060202MFN-VP1																										0.03~0.10	0.08~1.50	
		CCGT 060204MFN-VP1																										0.05~0.12	0.10~1.50	
		CCGT 09T301MFN-VP1																										0.03~0.13	0.06~1.00	
		CCGT 09T302MFN-VP1																										0.04~0.15	0.08~1.50	
		CCGT 09T304MFN-VP1																										0.06~0.20	0.10~1.50	
Medium to finishing	 KM	CCGT 0602003R-KM																									0.01~0.06	0.04~1.30		
		CCGT 060201R-KM																										0.02~0.08	0.05~1.50	
		CCGT 060202R-KM																								●		0.03~0.11	0.06~1.70	
		CCGT 09T3003R-KM																										0.02~0.08	0.06~1.50	
		CCGT 09T301R-KM																										0.03~0.11	0.06~1.70	
		CCGT 09T302R-KM																										0.04~0.15	0.08~2.00	
		CCGT 0602003L-KM																										0.01~0.06	0.04~1.30	
		CCGT 060201L-KM																											0.02~0.08	0.05~1.50
		CCGT 060202L-KM																											0.03~0.11	0.06~1.70
		CCGT 09T3003L-KM																											0.02~0.08	0.06~1.50
CCGT 09T301L-KM																											0.03~0.11	0.06~1.70		
CCGT 09T302L-KM																											0.04~0.15	0.08~2.00		
Finishing	 HFP	CCMT 060202-HFP																									0.03~0.06	0.08~1.20		
		CCMT 060204-HFP																										0.05~0.12	0.10~1.20	
		CCMT 060208-HFP																										0.05~0.12	0.10~1.40	
		CCMT 09T302-HFP																										0.04~0.16	0.08~1.50	
		CCMT 09T304-HFP																										0.06~0.18	0.10~1.50	
		CCMT 09T308-HFP																										0.08~0.25	0.20~1.50	
		CCMT 120404-HFP																										0.07~0.22	0.10~2.00	
		CCMT 120408-HFP																										0.08~0.30	0.12~2.20	
Finishing	 VF	CCMT 060202-VF					●		●	●									●								0.05~0.20	0.30~1.00		
		CCMT 060204-VF	●	●	●		●		●	●									●	●								0.10~0.25	0.30~1.00	
		CCMT 09T302-VF					●		●	●																		0.04~0.16	0.80~1.50	
		CCMT 09T304-VF	●	●	●		●		●	●										●	●							0.05~0.20	0.30~1.50	
		CCMT 09T308-VF			●				●	●										●	●							0.10~0.25	0.30~1.50	
		CCMT 120404-VF					●		●	●										●								0.07~0.22	0.10~2.00	

🔄 Cutting edge geometry A38 ~ A43
🔄 Recommended chip breaker B04 ~ B11
🔄 Code system B18 ~ B19
● : Stock item

Available tool holders			
Designation	Page	Designation	Page
SCACR/L	B123,177	SCLCR/L	B123,144,151,177

# B Turning Insert (Positive)



**Rhombic 80° Positive**  
Relief Angle : 7°

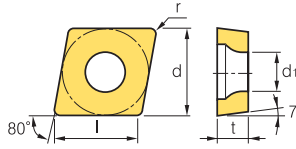

Dimensions(mm)			
Size	d	t	d1
06	6.35	2.38	2.8
08	7.94	3.18	3.4
09	9.525	3.97	4.4
12	12.7	4.76	5.5

Workpiece	Material		Cutting Conditions																Machining types														
	Symbol	Material	1	2	3	4	5	6	7	8	9	10	11	12	13	14	15	16															
Steel	P	Steel	•	•	•	•	•	•	•	•	•	•	•	•	•	•	•	•	•	•	•	•	•	•	•	•	•	•	•	•	•	•	● Continuous cutting ● General cutting ✳ Interrupted cutting
Stainless steel	M	Stainless steel	•	•	•	•	•	•	•	•	•	•	•	•	•	•	•	•	•	•	•	•	•	•	•	•	•	•	•	•			
Cast iron	K	Cast iron	•	•	•	•	•	•	•	•	•	•	•	•	•	•	•	•	•	•	•	•	•	•	•	•	•	•	•	•			
Non-ferrous metal	N	Non-ferrous metal	•	•	•	•	•	•	•	•	•	•	•	•	•	•	•	•	•	•	•	•	•	•	•	•	•	•	•	•			
Heat resistant alloy, Titanium alloy	S	Heat resistant alloy, Titanium alloy	•	•	•	•	•	•	•	•	•	•	•	•	•	•	•	•	•	•	•	•	•	•	•	•	•	•	•	•			
Hardened steel	H	Hardened steel	•	•	•	•	•	•	•	•	•	•	•	•	•	•	•	•	•	•	•	•	•	•	•	•	•	•	•	•			

Inserts	Designation	Cermets		Coated		Coated													Uncoated		Cutting Condition										
		CN1500	CN2000	CN2500	CC1500	CC2500	NC3010	NC3215	NC3120	NC3220	NC3225	NC3030	NC5330	NC9020	NC9025	NC6210	NC6215	PC5300	PC5400	PC8105	PC8110	PC8115	PC9030	H01	H05	fn (mm/rev)	ap (mm)				
Finishing 	CCMT 060204-VL	•	•	•	•	•	•	•	•	•	•	•	•	•	•	•	•	•	•	•	•	•	•	•	•	•	•	•	•	•	•
	09T304-VL	•	•	•	•	•	•	•	•	•	•	•	•	•	•	•	•	•	•	•	•	•	•	•	•	•	•	•	•	•	•
	09T308-VL	•	•	•	•	•	•	•	•	•	•	•	•	•	•	•	•	•	•	•	•	•	•	•	•	•	•	•	•	•	•
Medium to finishing 	CCMT 060202-HMP	•	•	•	•	•	•	•	•	•	•	•	•	•	•	•	•	•	•	•	•	•	•	•	•	•	•	•	•	•	
	060204-HMP	•	•	•	•	•	•	•	•	•	•	•	•	•	•	•	•	•	•	•	•	•	•	•	•	•	•	•	•	•	
	060208-HMP	•	•	•	•	•	•	•	•	•	•	•	•	•	•	•	•	•	•	•	•	•	•	•	•	•	•	•	•	•	
	09T302-HMP	•	•	•	•	•	•	•	•	•	•	•	•	•	•	•	•	•	•	•	•	•	•	•	•	•	•	•	•	•	
	09T304-HMP	•	•	•	•	•	•	•	•	•	•	•	•	•	•	•	•	•	•	•	•	•	•	•	•	•	•	•	•	•	
	09T308-HMP	•	•	•	•	•	•	•	•	•	•	•	•	•	•	•	•	•	•	•	•	•	•	•	•	•	•	•	•	•	
	120404-HMP	•	•	•	•	•	•	•	•	•	•	•	•	•	•	•	•	•	•	•	•	•	•	•	•	•	•	•	•	•	
	120408-HMP	•	•	•	•	•	•	•	•	•	•	•	•	•	•	•	•	•	•	•	•	•	•	•	•	•	•	•	•	•	
120412-HMP	•	•	•	•	•	•	•	•	•	•	•	•	•	•	•	•	•	•	•	•	•	•	•	•	•	•	•	•	•		
Medium to finishing 	CCMT 060202-MP	•	•	•	•	•	•	•	•	•	•	•	•	•	•	•	•	•	•	•	•	•	•	•	•	•	•	•	•	•	
	060204-MP	•	•	•	•	•	•	•	•	•	•	•	•	•	•	•	•	•	•	•	•	•	•	•	•	•	•	•	•	•	
	09T302-MP	•	•	•	•	•	•	•	•	•	•	•	•	•	•	•	•	•	•	•	•	•	•	•	•	•	•	•	•	•	
	09T304-MP	•	•	•	•	•	•	•	•	•	•	•	•	•	•	•	•	•	•	•	•	•	•	•	•	•	•	•	•	•	
	09T308-MP	•	•	•	•	•	•	•	•	•	•	•	•	•	•	•	•	•	•	•	•	•	•	•	•	•	•	•	•	•	
Medium 	CCMT 060202-C25	•	•	•	•	•	•	•	•	•	•	•	•	•	•	•	•	•	•	•	•	•	•	•	•	•	•	•	•	•	
	060204-C25	•	•	•	•	•	•	•	•	•	•	•	•	•	•	•	•	•	•	•	•	•	•	•	•	•	•	•	•	•	
	060208-C25	•	•	•	•	•	•	•	•	•	•	•	•	•	•	•	•	•	•	•	•	•	•	•	•	•	•	•	•	•	
	080308-C25	•	•	•	•	•	•	•	•	•	•	•	•	•	•	•	•	•	•	•	•	•	•	•	•	•	•	•	•	•	
	09T304-C25	•	•	•	•	•	•	•	•	•	•	•	•	•	•	•	•	•	•	•	•	•	•	•	•	•	•	•	•	•	
	09T308-C25	•	•	•	•	•	•	•	•	•	•	•	•	•	•	•	•	•	•	•	•	•	•	•	•	•	•	•	•	•	
	120404-C25	•	•	•	•	•	•	•	•	•	•	•	•	•	•	•	•	•	•	•	•	•	•	•	•	•	•	•	•	•	
	120408-C25	•	•	•	•	•	•	•	•	•	•	•	•	•	•	•	•	•	•	•	•	•	•	•	•	•	•	•	•	•	
120412-C25	•	•	•	•	•	•	•	•	•	•	•	•	•	•	•	•	•	•	•	•	•	•	•	•	•	•	•	•	•		

Cutting edge geometry A38 ~ A43  
 Recommended chip breaker B04 ~ B11  
 Code system B18 ~ B19  
 ● : Stock item

Available tool holders			
Designation	Page	Designation	Page
SCACR/L	B123,177	SCLCR/L	B123,144,151,177



# CP



**Rhombic 80° Positive**  
Relief Angle : 11°

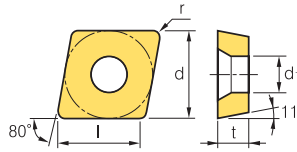

Dimensions(mm)			
Size	d	t	d1
08	7.94	2.38	3.4
09	9.525	3.18	4.4

Workpiece	Machining types															
	P	M	K	N	S	H	1	2	3	4	5	6	7	8	9	10
Steel	●	●	●	●	●	●	●	●	●	●	●	●	●	●	●	●
Stainless steel	●	●	●	●	●	●	●	●	●	●	●	●	●	●	●	●
Cast iron	●	●	●	●	●	●	●	●	●	●	●	●	●	●	●	●
Non-ferrous metal	●	●	●	●	●	●	●	●	●	●	●	●	●	●	●	●
Heat resistant alloy, Titanium alloy	●	●	●	●	●	●	●	●	●	●	●	●	●	●	●	●
Hardened steel	●	●	●	●	●	●	●	●	●	●	●	●	●	●	●	●

● Continuous cutting  
 ● General cutting  
 ● Interrupted cutting

Inserts	Designation	Cermet		Coated		Coated										Uncoated		Cutting Condition											
		CN1500	CN2000	CN2500	CC1500	CC2500	NC3010	NC3215	NC3120	NC3220	NC3225	NC3030	NC5330	NC9020	NC9025	NC6205	NC6210	NC6215	PC5300	PC5400	PC8105	PC8110	PC8115	H01	H05	fn (mm/rev)	ap (mm)		
Finishing	CPGT	080202	●																							0.06~0.20	0.10~2.00		
		080204	●	●																							0.08~0.20	0.30~2.00	
		080208																									0.10~0.25	0.50~2.00	
		090302																									0.04~0.20	0.30~1.50	
		090304	●	●																								0.06~0.25	0.50~2.00
		090308																										0.08~0.30	0.70~2.50
Finishing	CPGT	080204-C05																									0.02~0.15	0.50~1.70	
		080208-C05																									0.04~0.18	0.50~1.70	
		090304-C05																									0.03~0.20	0.70~2.00	
		090308-C05																									0.05~0.20	0.70~2.00	
Medium to finishing	CPGT	090308-HMP																									0.05~0.20	0.70~2.00	
Finishing	CPMT	080204-VF																									0.05~0.20	0.30~1.20	
		080208-VF																									0.10~0.25	0.30~1.20	
		090304-VF																									0.05~0.20	0.30~1.50	
		090308-VF																									0.10~0.25	0.30~1.50	

⚙️ Cutting edge geometry A38 ~ A43  
 ⚙️ Recommended chip breaker B04 ~ B11  
 ⚙️ Code system B18 ~ B19  
 ● : Stock item

Available tool holders			
Designation	Page	Designation	Page
SCLPRL	B144, B152		

# B Turning Insert (Positive)

DC○○○



Rhombic **55° Positive**  
Relief Angle : 7°

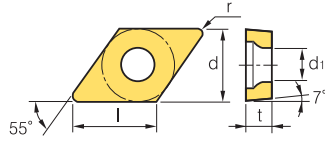

Dimensions(mm)			
Size	d	t	d1
07	6.35	2.38	2.8
11	9.525	3.97	4.4

Workpiece											Machining types			
	Steel	Stainless steel	Cast iron	Non-ferrous metal	Heat resistant alloy, Titanium alloy	Hardened steel								
	P	M	K	N	S	H								

● Continuous cutting  
 ● General cutting  
 ✦ Interrupted cutting

Inserts	Designation	Cermet		Coated		Coated										Uncoated		Cutting Condition											
		CN1500	CN2000	CN2500	CC1500	CC2500	NC3010	NC3215	NC3120	NC3220	NC3225	NC3030	NC5330	NC9020	NC9025	NC6205	NC6210	NC6215	PC5300	PC5400	PC8105	PC8110	PC8115	H01	H05	fn (mm/rev)	ap (mm)		
Finishing (High precision) 	DCET	0702005MFR-KF																								0.01~0.06	0.04~1.30		
		070201MFR-KF																									0.02~0.08	0.05~1.50	
		070202MFR-KF																									0.03~0.11	0.06~1.70	
		11T3005MFR-KF																										0.02~0.08	0.05~1.50
		11T301MFR-KF																										0.03~0.11	0.06~1.70
		11T302MFR-KF																										0.04~0.15	0.08~2.00
		0702005MFL-KF																										0.01~0.06	0.04~1.30
		070201MFL-KF																										0.02~0.08	0.05~1.50
		070202MFL-KF																										0.03~0.11	0.06~1.70
		11T3005MFL-KF																										0.02~0.08	0.05~1.50
		11T301MFL-KF																										0.03~0.11	0.06~1.70
		11T302MFL-KF																										0.04~0.15	0.08~2.00
Medium to finishing (High precision) 	DCET	0702005MFR-KM																									0.01~0.06	0.04~1.30	
		070201MFR-KM																									0.02~0.08	0.05~1.50	
		070202MFR-KM																									0.03~0.11	0.06~1.70	
		11T3005MFR-KM																										0.02~0.08	0.05~1.50
		11T301MFR-KM																										0.03~0.11	0.06~1.70
		11T302MFR-KM																										0.04~0.15	0.08~2.00
		0702005MFL-KM																										0.01~0.06	0.04~1.30
		070201MFL-KM																										0.02~0.08	0.05~1.50
		070202MFL-KM																										0.03~0.11	0.06~1.70
		11T3005MFL-KM																										0.02~0.08	0.05~1.50
		11T301MFL-KM																										0.03~0.11	0.06~1.70
		11T302MFL-KM																										0.04~0.15	0.08~2.00
Finishing 	DCGT	070202-C05																									0.06~0.11	0.06~1.50	
		070204-C05																									0.05~0.17	0.08~1.50	
		11T302-C05																									0.04~0.15	0.08~2.00	
		11T304-C05																									0.06~0.23	0.10~2.00	
		11T308-C05																									0.08~0.30	0.20~2.00	
Finishing 	DCGT	070202-HFP																									0.03~0.10	0.06~1.00	
		070204-HFP																									0.05~0.12	0.08~1.00	
		070208-HFP																									0.06~0.12	0.10~1.00	
		11T301-HFP																									0.03~0.13	0.06~1.00	
		11T302-HFP																									0.04~0.15	0.08~1.50	
		11T304-HFP																									0.06~0.20	0.10~1.50	
		11T308-HFP																									0.08~0.25	0.20~1.50	

Cutting edge geometry A38 ~ A43  
 Recommended chip breaker B04 ~ B11  
 Code system B18 ~ B19  
 ● : Stock item

Available tool holders			
Designation	Page	Designation	Page
SDACR/L	B123	SDQCR/L	B145
SDJCR/L	B124, 177	SDUCR/L	B145
SDNCN	B124, 178	SDZCR/L	B146



## DC



**Rhombic 55° Positive**  
Relief Angle : 7°

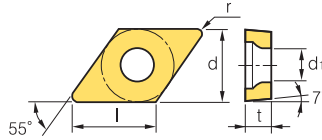

Dimensions(mm)			
Size	d	t	d1
07	6.35	2.38	2.8
11	9.525	3.97	4.4

Workpiece	Machining types															
	P	M	K	N	S	H	1	2	3	4	5	6	7	8	9	10
Steel	●	●	●	●	●	●	●	●	●	●	●	●	●	●	●	●
Stainless steel	●	●	●	●	●	●	●	●	●	●	●	●	●	●	●	●
Cast iron	●	●	●	●	●	●	●	●	●	●	●	●	●	●	●	●
Non-ferrous metal	●	●	●	●	●	●	●	●	●	●	●	●	●	●	●	●
Heat resistant alloy, Titanium alloy	●	●	●	●	●	●	●	●	●	●	●	●	●	●	●	●
Hardened steel	●	●	●	●	●	●	●	●	●	●	●	●	●	●	●	●

● Continuous cutting  
 ● General cutting  
 ● Interrupted cutting

Inserts	Designation	Cermet		Coated		Coated										Uncoated		Cutting Condition												
		CN1500	CN2000	CN2500	CC1500	CC2500	NC3010	NC3215	NC3120	NC3220	NC3225	NC3030	NC5330	NC9020	NC9025	NC6210	NC6215	PC5300	PC5400	PC8105	PC8110	PC8115	PC9030	H01	H05	fn (mm/rev)	ap (mm)			
Finishing 	DCGT	0702003R-KF																									0.01~0.06	0.04~1.30		
		070201R-KF																										0.02~0.08	0.05~1.50	
		070202R-KF																										0.03~0.11	0.06~1.50	
		11T3003R-KF																										0.02~0.08	0.05~1.50	
		11T301R-KF																							●			0.03~0.11	0.06~1.70	
		11T302R-KF																							●			0.04~0.15	0.08~2.00	
		0702003L-KF																										0.01~0.06	0.04~1.30	
		070201L-KF																											0.02~0.08	0.05~1.50
		070202L-KF																											0.03~0.11	0.06~1.50
		11T3003L-KF																											0.02~0.08	0.05~1.50
		11T301L-KF																											0.03~0.11	0.06~1.70
	11T302L-KF																											0.04~0.15	0.08~2.00	
Finishing 	DCGT	070201-VP1																●	●	●	●				●		0.03~0.06	0.06~1.00		
		070202-VP1																●	●	●	●				●		0.03~0.10	0.08~1.50		
		070204-VP1									●							●	●	●	●				●		0.05~0.12	0.10~1.50		
		11T301-VP1																●	●	●	●				●		0.03~0.13	0.06~1.00		
		11T302-VP1																●	●	●	●				●		0.04~0.15	0.08~1.50		
		11T304-VP1																●	●	●	●				●		0.06~0.20	0.10~1.50		
Finishing (High precision) 	DCGT	070201MFN-VP1																	●	●	●	●					0.03~0.06	0.06~1.00		
		070202MFN-VP1																		●	●	●	●					0.03~0.10	0.08~1.50	
		070204MFN-VP1																			●	●	●	●				0.05~0.12	0.10~1.50	
		11T301MFN-VP1																			●	●	●	●				0.03~0.13	0.06~1.00	
		11T302MFN-VP1																				●	●	●	●				0.04~0.15	0.08~1.50
		11T304MFN-VP1																					●	●	●	●			0.06~0.20	0.10~1.50
Medium to finishing 	DCGT	0702003R-KM																									0.01~0.06	0.04~1.30		
		070201R-KM																										0.02~0.08	0.05~1.50	
		070202R-KM																										0.03~0.11	0.06~1.50	
		11T3003R-KM																										0.02~0.08	0.05~1.50	
		11T301R-KM																										0.03~0.11	0.06~1.70	
		11T302R-KM																										0.04~0.15	0.08~2.00	
		0702003L-KM																										0.01~0.06	0.04~1.30	
		070201L-KM																											0.02~0.08	0.05~1.50
		070202L-KM																											0.03~0.11	0.06~1.50
		11T3003L-KM																											0.02~0.08	0.05~1.50
		11T301L-KM																											0.03~0.11	0.06~1.70
	11T302L-KM																											0.04~0.15	0.08~2.00	

⚙ Cutting edge geometry A38 ~ A43   
 ⚙ Recommended chip breaker B04 ~ B11   
 ⚙ Code system B18 ~ B19   
 ● : Stock item

Available tool holders			
Designation	Page	Designation	Page
SDACR/L	B123	SDQCR/L	B145
SDJCR/L	B124, 177	SDUCR/L	B145
SDNCN	B124, 178	SDZCR/L	B146



# B Turning Insert (Positive)



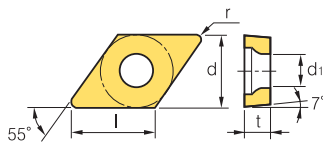

DC ○ ○ ○

 Rhombic **55° Positive**  
Relief Angle : 7°

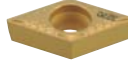

Dimensions(mm)			
Size	d	t	d1
07	6.35	2.38	2.8
11	9.525	3.97	4.4

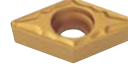
Workpiece	Material												Machining types		
	Steel	Stainless steel	Cast iron	Non-ferrous metal	Heat resistant alloy, Titanium alloy	Hardened steel	P	M	K	N	S	H	Continuous cutting	General cutting	Interrupted cutting
Steel							●	●	●	●	●	●	●	●	●
Stainless steel		●	●	●	●	●	●	●	●	●	●	●	●	●	●
Cast iron			●	●	●	●	●	●	●	●	●	●	●	●	●
Non-ferrous metal				●	●	●	●	●	●	●	●	●	●	●	●
Heat resistant alloy, Titanium alloy					●	●	●	●	●	●	●	●	●	●	●
Hardened steel						●	●	●	●	●	●	●	●	●	●

Inserts	Designation	Cermet		Coated		Coated										Uncoated		Cutting Condition											
		CN1500	CN2000	CN2500	CC1500	CC2500	NC3010	NC3215	NC3120	NC3220	NC3225	NC3030	NC5330	NC9020	NC9025	NC6210	NC6215	PC5300	PC5400	PC8105	PC8110	PC8115	PC9030	H01	H05	fn (mm/rev)	ap (mm)		
Finishing 	DCMT 070202-HFP																										0.03~0.10	0.06~1.00	
	DCMT 070204-HFP																											0.05~0.12	0.08~1.00
	DCMT 070208-HFP																											0.06~0.12	0.10~1.00
	DCMT 11T301-HFP																											0.03~0.13	0.06~1.00
	DCMT 11T302-HFP																											0.04~0.15	0.08~1.50
	DCMT 11T304-HFP																											0.06~0.20	0.10~1.50
	DCMT 11T308-HFP																											0.08~0.25	0.20~1.50
Finishing 	DCMT 070204-VL	●	●		●		●		●		●		●		●		●		●		●		●		●	●	0.04~0.10	0.08~0.90	
	DCMT 11T304-VL	●	●	●	●	●	●	●	●	●	●	●	●	●	●	●	●	●	●	●	●	●	●	●	●	●	0.05~0.10	0.10~1.00	
	DCMT 11T308-VL	●	●	●	●	●	●	●	●	●	●	●	●	●	●	●	●	●	●	●	●	●	●	●	●	●	0.08~0.15	0.10~1.00	
Finishing 	DCMT 070202-VF			●			●		●		●		●		●		●		●		●		●		●		0.03~0.10	0.06~1.00	
	DCMT 070204-VF		●	●			●		●		●		●		●		●		●		●		●		●		0.05~0.20	0.30~1.20	
	DCMT 11T302-VF	●					●		●		●		●		●		●		●		●		●		●		0.04~0.15	0.08~1.50	
	DCMT 11T304-VF	●	●	●			●		●		●		●		●		●		●		●		●		●		0.05~0.20	0.30~1.50	
	DCMT 11T308-VF	●	●	●			●		●		●		●		●		●		●		●		●		●		0.10~0.25	0.30~1.50	
Medium to finishing 	DCMT 070202-HMP	●	●				●		●		●		●		●		●		●		●		●		●		0.03~0.12	0.10~1.50	
	DCMT 070204-HMP	●	●	●			●		●		●		●		●		●		●		●		●		●		0.06~0.17	0.20~2.30	
	DCMT 070208-HMP						●		●		●		●		●		●		●		●		●		●		0.08~0.23	0.40~2.30	
	DCMT 11T302-HMP						●		●		●		●		●		●		●		●		●		●		0.04~0.22	0.10~2.00	
	DCMT 11T304-HMP	●	●	●			●		●		●		●		●		●		●		●		●		●		0.08~0.23	0.30~3.00	
	DCMT 11T308-HMP	●	●	●			●		●		●		●		●		●		●		●		●		●		0.10~0.30	0.50~3.00	
Medium 	DCMT 070202-MP	●	●	●	●		●		●		●		●		●		●		●		●		●		●		0.04~0.12	0.12~1.80	
	DCMT 070204-MP	●	●	●	●		●		●		●		●		●		●		●		●		●		●		0.05~0.15	0.30~1.80	
	DCMT 070208-MP	●	●	●	●		●		●		●		●		●		●		●		●		●		●		0.08~0.22	0.30~1.80	
	DCMT 11T302-MP	●	●	●	●		●		●		●		●		●		●		●		●		●		●		0.04~0.15	0.30~2.00	
	DCMT 11T304-MP	●	●	●	●		●		●		●		●		●		●		●		●		●		●		0.08~0.20	0.50~2.30	
	DCMT 11T308-MP	●	●	●	●		●		●		●		●		●		●		●		●		●		●		0.10~0.30	0.50~2.30	
Medium 	DCMT 070202-C25	●	●	●	●		●		●		●		●		●		●		●		●		●		●		0.03~0.15	0.30~2.00	
	DCMT 070204-C25	●	●	●	●		●		●		●		●		●		●		●		●		●		●		0.05~0.20	0.50~2.50	
	DCMT 070208-C25	●	●	●	●		●		●		●		●		●		●		●		●		●		●		0.06~0.25	0.80~2.50	
	DCMT 11T302-C25	●	●	●	●		●		●		●		●		●		●		●		●		●		●		0.04~0.25	0.50~2.50	
	DCMT 11T304-C25	●	●	●	●		●		●		●		●		●		●		●		●		●		●		0.08~0.30	0.80~3.00	
	DCMT 11T308-C25	●	●	●	●		●		●		●		●		●		●		●		●		●		●		0.10~0.30	1.00~3.00	

 Cutting edge geometry A38 ~ A43  
  Recommended chip breaker B04 ~ B11  
  Code system B18 ~ B19  
 ● : Stock item

Available tool holders			
Designation	Page	Designation	Page
SDACR/L	B123	SDQCR/L	B145
SDJCR/L	B124, 177	SDUCR/L	B145
SDNCN	B124, 178	SDZCR/L	B146





## RC ○○



**Round R° Positive**  
Relief Angle : 7°

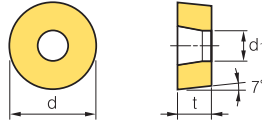

Dimensions(mm)			
Size	d	t	d1
10	10.0	3.18	3.6
12	12.0	4.76	4.2
16	16.0	6.35	5.2
20	20.0	6.35	6.5
25	25.0	7.94	7.25
32	32.0	9.52	9.55

Workpiece	Machining types															
	P	M	K	N	S	H	1	2	3	4	5	6	7	8	9	10
Steel	●	●	●	●	●	●	●	●	●	●	●	●	●	●	●	●
Stainless steel	●	●	●	●	●	●	●	●	●	●	●	●	●	●	●	●
Cast iron	●	●	●	●	●	●	●	●	●	●	●	●	●	●	●	●
Non-ferrous metal	●	●	●	●	●	●	●	●	●	●	●	●	●	●	●	●
Heat resistant alloy, Titanium alloy	●	●	●	●	●	●	●	●	●	●	●	●	●	●	●	●
Hardened steel	●	●	●	●	●	●	●	●	●	●	●	●	●	●	●	●

Inserts	Designation	Cermert		Coated		Coated										Uncoated		Cutting Condition											
		CN1500	CN2000	CN2500	CC1500	CC2500	NC3010	NC3215	NC3120	NC3220	NC3225	NC3030	NC5330	NC9020	NC9025	NC6205	NC6210	NC6215	PC5300	PC5400	PC8105	PC8110	PC8115	H01	H05	fn (mm/rev)	ap (mm)		
Medium	RCMX	1003M0							●	●	●	●														0.25~0.50	1.50~4.00		
		1204M0							●	●	●	●					●										0.30~0.60	2.50~5.00	
		1606M0									●		●	●				●										0.40~0.70	3.00~7.00
		2006M0											●					●										0.48~0.90	3.50~9.00
		2507M0												●														0.55~1.20	4.00~12.00
		3209M0												●														0.65~1.50	5.00~15.00

Cutting edge geometry A38 ~ A43  
 Recommended chip breaker B04 ~ B11  
 Code system B18 ~ B19  
 ● : Stock item

Available tool holders			
Designation	Page	Designation	Page
PRDCN	B107	PRGCR/L	B107

## SC ○○



**Square 90° Positive**  
Relief Angle : 7°

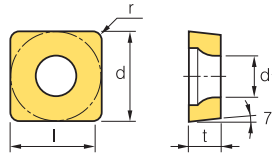

Dimensions(mm)			
Size	d	t	d1
09	9.525	3.97	4.4
12	12.7	4.76	5.5

Workpiece	Machining types															
	P	M	K	N	S	H	1	2	3	4	5	6	7	8	9	10
Steel	●	●	●	●	●	●	●	●	●	●	●	●	●	●	●	●
Stainless steel	●	●	●	●	●	●	●	●	●	●	●	●	●	●	●	●
Cast iron	●	●	●	●	●	●	●	●	●	●	●	●	●	●	●	●
Non-ferrous metal	●	●	●	●	●	●	●	●	●	●	●	●	●	●	●	●
Heat resistant alloy, Titanium alloy	●	●	●	●	●	●	●	●	●	●	●	●	●	●	●	●
Hardened steel	●	●	●	●	●	●	●	●	●	●	●	●	●	●	●	●

Inserts	Designation	Cermert		Coated		Coated										Uncoated		Cutting Condition										
		CN1500	CN2000	CN2500	CC1500	CC2500	NC3010	NC3215	NC3120	NC3220	NC3225	NC3030	NC5330	NC9020	NC9025	NC6205	NC6210	NC6215	PC5300	PC5400	PC8105	PC8110	PC9030	H01	H05	fn (mm/rev)	ap (mm)	
Finishing	SCGT	09T304-C05																								0.11~0.23	0.10~2.00	
		09T308-C05																									0.08~0.30	0.20~2.00
		120408-C05																										0.08~0.33

Cutting edge geometry A38 ~ A43  
 Recommended chip breaker B04 ~ B11  
 Code system B18 ~ B19  
 ● : Stock item

Available tool holders			
Designation	Page	Designation	Page
SSBCR/L	B125	SSKCR/L	B126,173
SSDCN	B125	SSSCR/L	B126,173



# B Turning Insert (Positive)

SC ○ ○

 Square **90° Positive**  
Relief Angle : 7°

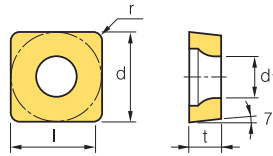

Dimensions(mm)			
Size	d	t	d1
06	6.35	2.38	2.8
09	9.525	3.97	4.4
12	12.7	4.76	5.5

Workpiece	Material Groups												Machining types					
	P	M	K	N	S	H	1	2	3	4	5	6	7	8	9	10	11	12
Steel	●	●	●	●	●	●	●	●	●	●	●	●	●	●	●	●	●	●
Stainless steel	●	●	●	●	●	●	●	●	●	●	●	●	●	●	●	●	●	●
Cast iron	●	●	●	●	●	●	●	●	●	●	●	●	●	●	●	●	●	●
Non-ferrous metal	●	●	●	●	●	●	●	●	●	●	●	●	●	●	●	●	●	●
Heat resistant alloy, Titanium alloy	●	●	●	●	●	●	●	●	●	●	●	●	●	●	●	●	●	●
Hardened steel	●	●	●	●	●	●	●	●	●	●	●	●	●	●	●	●	●	●

● Continuous cutting  
 ● General cutting  
 ✦ Interrupted cutting

Inserts	Designation	Cermets		Coated		Coated										Uncoated		Cutting Condition											
		CN1500	CN2000	CN2500	CC1500	CC2500	NC3010	NC3215	NC3120	NC3220	NC3225	NC3030	NC5330	NC9020	NC9025	NC6210	NC6215	PC5300	PC5400	PC8105	PC8110	PC8115	PC9030	H01	H05	fn (mm/rev)	ap (mm)		
Finishing	HFP	SCGT	09T304-HFP																								0.05~0.25	0.10~1.50	
		SCMT	09T304-HFP																									0.05~0.25	0.10~1.50
Finishing	VF	SCMT	09T304-VF		●					●	●						●			●							0.05~0.20	0.30~1.50	
Finishing	VL	SCMT	09T304-VL	●	●	●	●	●	●	●	●	●	●	●	●	●	●	●	●	●	●	●	●	●	●	●	●	0.05~0.10	0.10~1.00
		SCMT	09T308-VL	●	●	●	●	●	●	●	●	●	●	●	●	●	●	●	●	●	●	●	●	●	●	●	●	0.08~0.15	0.10~1.00
Medium to finishing	HMP	SCMT	09T304-HMP	●	●				●	●	●	●	●	●	●	●	●	●	●	●	●	●	●	●	●	●	0.08~0.23	0.30~3.00	
		SCMT	09T308-HMP	●				●	●	●	●	●	●	●	●	●	●	●	●	●	●	●	●	●	●	●	0.10~0.30	0.50~3.00	
		SCMT	120404-HMP							●	●	●	●	●	●	●	●	●	●	●	●	●	●	●	●	●	0.09~0.27	0.30~3.60	
		SCMT	120408-HMP							●	●	●	●	●	●	●	●	●	●	●	●	●	●	●	●	●	●	0.12~0.36	0.60~3.60
Medium to finishing	MP	SCMT	09T304-MP						●	●	●	●	●	●	●	●	●	●	●	●	●	●	●	●	●	●	0.05~0.25	0.30~2.80	
		SCMT	09T308-MP						●	●	●	●	●	●	●	●	●	●	●	●	●	●	●	●	●	●	0.10~0.30	0.50~2.80	
		SCMT	120408-MP							●	●	●	●	●	●	●	●	●	●	●	●	●	●	●	●	●	0.15~0.35	0.80~3.50	
Medium	C25	SCMT	060204-C25										●														0.08~0.25	0.40~2.50	
		SCMT	09T304-C25	●	●	●	●	●	●	●	●	●	●	●	●	●	●	●	●	●	●	●	●	●	●	●	0.08~0.25	0.60~3.00	
		SCMT	09T308-C25	●	●	●	●	●	●	●	●	●	●	●	●	●	●	●	●	●	●	●	●	●	●	●	●	0.10~0.30	1.00~3.00
		SCMT	120404-C25	●	●	●	●	●	●	●	●	●	●	●	●	●	●	●	●	●	●	●	●	●	●	●	●	0.10~0.30	0.80~3.80
		SCMT	120408-C25	●	●	●	●	●	●	●	●	●	●	●	●	●	●	●	●	●	●	●	●	●	●	●	●	0.12~0.38	1.20~3.80

 Cutting edge geometry A38 ~ A43  
  Recommended chip breaker B04 ~ B11  
  Code system B18 ~ B19  
 ● : Stock item

Available tool holders			
Designation	Page	Designation	Page
SSBCR/L	B125	SSKCR/L	B126, 173
SSDCN	B125	SSSCR/L	B126, 173



# SP



**Square 90° Positive**  
Relief Angle : 11°

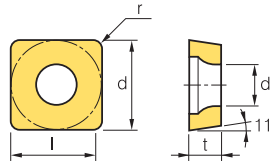

Dimensions(mm)			
Size	d	t	d1
06	6.35	2.38	2.8
07	7.94	2.38	-
09	9.525	3.18	3.4
12	12.7	4.76	-
15	15.875	4.76	-
19	19.05	4.76	-

Workpiece	Machining types															
	P	M	K	N	S	H	1	2	3	4	5	6	7	8	9	10
Steel	●	●	●	●	●	●	●	●	●	●	●	●	●	●	●	●
Stainless steel	●	●	●	●	●	●	●	●	●	●	●	●	●	●	●	●
Cast iron	●	●	●	●	●	●	●	●	●	●	●	●	●	●	●	●
Non-ferrous metal	●	●	●	●	●	●	●	●	●	●	●	●	●	●	●	●
Heat resistant alloy, Titanium alloy	●	●	●	●	●	●	●	●	●	●	●	●	●	●	●	●
Hardened steel	●	●	●	●	●	●	●	●	●	●	●	●	●	●	●	●

Inserts	Designation	Cermet		Coated		Coated										Uncoated		Cutting Condition										
		CN1500	CN2000	CN2500	CC1500	CC2500	NC3010	NC3215	NC3120	NC3220	NC3225	NC3030	NC5330	NC9020	NC9025	NC6205	NC6210	NC6215	PC5300	PC5400	PC8105	PC8110	PC8115	H01	H05	fn (mm/rev)	ap (mm)	
Medium to finishing	SPGA	060204																								0.50~0.25	0.50~2.00	
		090308T	●	●																							0.10~0.25	0.70~3.00
		090308T-Z (Z=Special Nega land)	●																								0.10~0.25	0.70~3.00
Medium to finishing	SPGN	070202																								0.03~0.10	0.50~2.00	
		070208																									0.10~0.25	0.70~3.00
		090302																									0.03~0.10	0.50~3.00
		090304																									0.08~0.20	0.70~3.50
		090308																									0.10~0.25	0.70~3.50
		120302																									0.03~0.20	0.50~3.00
		120304																									0.08~0.20	1.00~5.00
		120308										●															0.10~0.25	1.00~5.00
		120312																									0.15~0.30	1.00~5.00
		120316																									0.18~0.33	1.00~5.00
		120402																									0.03~0.20	0.50~3.00
		120404																									0.08~0.20	1.00~5.00
		120408																									0.10~0.25	1.00~5.00
		120412																									0.15~0.30	1.00~5.00
		120416																									0.18~0.33	1.00~5.00
		120430																									0.20~0.60	2.00~5.00
		120440																									0.25~0.70	3.00~5.00
		150404																									0.08~0.20	1.50~7.00
		150408																									0.10~0.25	1.50~7.00
		150412																									0.15~0.30	1.50~7.00
	150416																									0.18~0.33	1.50~7.00	
	150420																									0.20~0.45	1.50~7.00	
	190404																									0.08~0.20	1.50~9.00	
	190408																									0.10~0.25	1.50~9.00	
	190412																									0.15~0.45	1.50~9.00	
	190416																									0.18~0.60	1.50~9.00	
	190424																									0.25~0.70	2.50~9.00	
Finishing	SPGR	090304-F																								0.05~0.20	0.30~2.00	
		120304-F																								0.10~0.25	0.50~2.00	

Cutting edge geometry **A38 ~ A43**  
 Recommended chip breaker **B04 ~ B11**  
 Code system **B18 ~ B19**  
 ● : Stock item

Available tool holders			
Designation	Page	Designation	Page
CSDPN	B114	SSKCR/L	B146
CSKPR/L	B115		

# B Turning Insert (Positive)

## SP ○○

 Square **90° Positive**  
Relief Angle : 11°

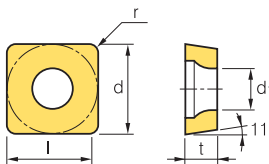

Dimensions(mm)			
Size	d	t	d1
09	9.525	3.18	3.4~4.4
12	12.7	3.18	-
15	15.875	4.76	-
19	19.05	4.76	-
25	25.4	6.35	-

Workpiece	Machining types																								
	P	M	K	N	S	H	NC3010	NC3215	NC3120	NC3220	NC3225	NC3030	NC5330	NC9020	NC9025	NC6205	NC6210	NC6215	PC5300	PC5400	PC8105	PC8110	PC8115	H01	H05
Steel	●	●	●	●	●	●	●	●	●	●	●	●	●	●	●	●	●	●	●	●	●	●	●	●	●
Stainless steel	●	●	●	●	●	●	●	●	●	●	●	●	●	●	●	●	●	●	●	●	●	●	●	●	●
Cast iron	●	●	●	●	●	●	●	●	●	●	●	●	●	●	●	●	●	●	●	●	●	●	●	●	●
Non-ferrous metal	●	●	●	●	●	●	●	●	●	●	●	●	●	●	●	●	●	●	●	●	●	●	●	●	●
Heat resistant alloy, Titanium alloy	●	●	●	●	●	●	●	●	●	●	●	●	●	●	●	●	●	●	●	●	●	●	●	●	●
Hardened steel	●	●	●	●	●	●	●	●	●	●	●	●	●	●	●	●	●	●	●	●	●	●	●	●	●

Inserts	Designation	Cermert		Coated		Coated											Uncoated		Cutting Condition										
		CN1500	CN2000	CN2500	CC1500	CC2500	NC3010	NC3215	NC3120	NC3220	NC3225	NC3030	NC5330	NC9020	NC9025	NC6205	NC6210	NC6215	PC5300	PC5400	PC8105	PC8110	PC8115	H01	H05	fn (mm/rev)	ap (mm)		
Medium	M	SPGR	090308-M																							0.10~0.40	1.00~3.50		
			120308-M																									0.20~0.40	1.50~4.00
Finishing	C05	SPGT	090304-C05	●																						0.11~0.23	0.10~2.00		
			090308-C05																									0.08~0.30	0.20~2.00
Medium to finishing	VF	SPGT	090304R																							0.08~0.23	0.30~3.00		
			090308R																								0.10~0.30	0.50~3.00	
			090304L	●																								0.08~0.23	0.30~3.00
			090308L	●																								0.10~0.30	0.50~3.00
Finishing	VF	SPMT	090304-VF																							0.05~0.20	0.30~1.50		
			090308-VF																								0.10~0.25	0.30~1.50	
Finishing	F	SPMR	090304-F																							0.05~0.20	0.30~2.00		
			120304-F							●	●																0.10~0.25	0.50~2.00	
Medium	M	SPMR	090308-M																							0.10~0.40	1.00~3.50		
			120308-M																								0.10~0.40	1.50~4.00	
			120312-M																								0.20~0.40	1.50~4.00	
Medium to finishing	SPUN	120304																								0.10~0.30	1.00~5.00		
		120308																								0.15~0.40	1.00~5.00		
		150412																								0.20~0.50	1.00~5.00		
		190412																								0.20~0.50	1.50~7.00		
		190416																								0.25~0.60	2.00~7.00		
		250620																								0.30~0.80	3.00~10.0		
		120308SN																								0.15~0.40	1.00~5.00		

 Cutting edge geometry A38 ~ A43  
  Recommended chip breaker B04 ~ B11  
  Code system B18 ~ B19  
 ● : Stock item

Available tool holders			
Designation	Page	Designation	Page
CSDPN	B114	SSKPR/L	B146
CSKPR/L	B115		



## TB ○○

Dimensions(mm)			
Size	d	t	d1
06	3.97	1.59	2.16

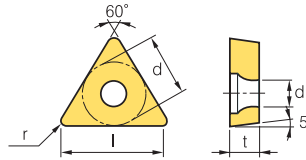

**Triangular 60° Positive**  
Relief Angle : 5°

Workpiece	Machining types											
	P	M	K	N	S	H	●	●	●	●	●	●
Steel	●	●	●	●	●	●	●	●	●	●	●	●
Stainless steel	●	●	●	●	●	●	●	●	●	●	●	●
Cast iron	●	●	●	●	●	●	●	●	●	●	●	●
Non-ferrous metal	●	●	●	●	●	●	●	●	●	●	●	●
Heat resistant alloy, Titanium alloy	●	●	●	●	●	●	●	●	●	●	●	●
Hardened steel	●	●	●	●	●	●	●	●	●	●	●	●

Inserts	Designation	Cermert		Coated		Coated										Uncoated		Cutting Condition									
		CN1500	CN2000	CN2500	CC1500	CC2500	NC3010	NC3215	NC3120	NC3220	NC3225	NC3030	NC5330	NC9020	NC9025	NC6205	NC6210	NC6215	PC5300	PC5400	PC8105	PC8110	PC9030	H01	H05	fn (mm/rev)	ap (mm)
Finishing	TBGT	060102L	●																					●	●	0.05~0.20	0.10~1.30
		060104L	●																								0.08~0.20

🔄 Cutting edge geometry A38 ~ A43
🔄 Recommended chip breaker B04 ~ B11
🔄 Code system B18 ~ B19
● : Stock item

Available tool holders			
Designation	Page	Designation	Page
STUBR	B148		

## TC ○○

Dimensions(mm)			
Size	d	t	d1
09	5.56	2.38	2.5
11	6.35	2.38	2.8

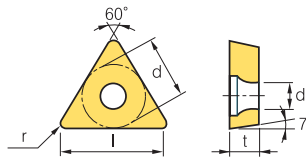

**Triangular 60° Positive**  
Relief Angle : 7°

Workpiece	Machining types											
	P	M	K	N	S	H	●	●	●	●	●	●
Steel	●	●	●	●	●	●	●	●	●	●	●	●
Stainless steel	●	●	●	●	●	●	●	●	●	●	●	●
Cast iron	●	●	●	●	●	●	●	●	●	●	●	●
Non-ferrous metal	●	●	●	●	●	●	●	●	●	●	●	●
Heat resistant alloy, Titanium alloy	●	●	●	●	●	●	●	●	●	●	●	●
Hardened steel	●	●	●	●	●	●	●	●	●	●	●	●

Inserts	Designation	Cermert		Coated		Coated										Uncoated		Cutting Condition										
		CN1500	CN2000	CN2500	CC1500	CC2500	NC3010	NC3215	NC3120	NC3220	NC3225	NC3030	NC5330	NC9020	NC9025	NC6205	NC6210	NC6215	PC5300	PC5400	PC8105	PC8110	PC8115	H01	H05	fn (mm/rev)	ap (mm)	
Finishing	TCGT	090204-C05																								0.05~0.19	0.10~1.70	
		110204-C05																									0.08~0.22	0.10~1.70
		110208-C05																										0.28~0.20

🔄 Cutting edge geometry A38 ~ A43
🔄 Recommended chip breaker B04 ~ B11
🔄 Code system B18 ~ B19
● : Stock item

Available tool holders			
Designation	Page	Designation	Page
STACR/L	B126,178	STTCR/L	B127,174
STFCR/L	B126,173	STWCR/L	B174
STGCR/L	B127		



# B Turning Insert (Positive)

## TC ○○



**Triangular 60° Positive**  
Relief Angle : 7°

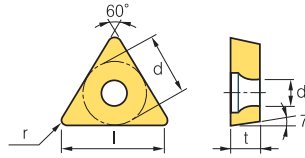

Dimensions(mm)			
Size	d	t	d1
08	4.76	2.38	2.3
09	5.56	2.38	2.5
11	6.35	2.38	2.8
16	9.523	3.97	4.4

Workpiece	Material		Machining types																		
	P	M	Continuous cutting	General cutting	Interrupted cutting																
Steel	●	●	●	●	●	●	●	●	●	●	●	●	●	●	●	●	●	●	●	●	●
Stainless steel	●	●	●	●	●	●	●	●	●	●	●	●	●	●	●	●	●	●	●	●	●
Cast iron	●	●	●	●	●	●	●	●	●	●	●	●	●	●	●	●	●	●	●	●	●
Non-ferrous metal	●	●	●	●	●	●	●	●	●	●	●	●	●	●	●	●	●	●	●	●	●
Heat resistant alloy, Titanium alloy	●	●	●	●	●	●	●	●	●	●	●	●	●	●	●	●	●	●	●	●	●
Hardened steel	●	●	●	●	●	●	●	●	●	●	●	●	●	●	●	●	●	●	●	●	●

Inserts	Designation	Cermets					Coated		Coated											Uncoated		Cutting Condition							
		CN1500	CN2000	CN2500	CC1500	CC2500	NC3010	NC3215	NC3120	NC3220	NC3225	NC3030	NC5330	NC9020	NC9025	NC6210	NC6215	PC5300	PC5400	PC8105	PC8110	PC8115	PC9030	H01	H05	fn (mm/rev)	ap (mm)		
Finishing	HFP	TCGT	090204-HFP																								0.05~0.19	0.10~1.70	
		110202-HFP																									0.03~0.13	0.06~1.70	
		110204-HFP																										0.05~0.19	0.10~1.70
		16T304-HFP																										0.07~0.26	0.10~1.70
Finishing	KF	TCGT	0802003R-KF																								0.01~0.06	0.04~1.30	
		080201R-KF																									0.02~0.08	0.05~1.50	
		080202R-KF																									0.03~0.11	0.06~1.70	
		0802003L-KF																										0.01~0.06	0.04~1.30
		080201L-KF																										0.02~0.08	0.05~1.50
		080202L-KF																										0.03~0.11	0.06~1.70
Finishing	HFP	TCMT	090204-HFP																								0.05~0.19	0.10~1.70	
		110202-HFP																									0.03~0.13	0.06~1.70	
		110204-HFP																										0.05~0.19	0.10~1.70
		16T302-HFP																										0.03~0.13	0.06~1.70
		16T304-HFP																										0.07~0.26	0.10~1.70
Finishing	VF	TCMT	110202-VF																								0.03~0.13	0.06~1.70	
		110204-VF	●																								0.05~0.20	0.30~1.20	
		110208-VF																										0.10~0.25	0.30~1.20
		16T302-VF																										0.05~0.15	0.10~1.30
		16T304-VF	●					●		●	●	●				●		●		●								0.05~0.20	0.30~1.50
Finishing (Mild steel)	VL	TCMT	110204-VL																								0.05~0.15	0.10~1.30	
		110208-VL																									0.08~0.20	0.10~1.30	
		16T304-VL	●	●	●	●	●	●	●	●	●	●				●	●	●	●	●	●	●					0.05~0.20	0.30~1.50	
		16T308-VL	●	●	●	●	●	●	●	●	●	●				●	●	●	●	●	●	●					0.05~0.20	0.30~1.50	
Medium to finishing	HMP	TCMT	090204-HMP																								0.06~0.17	0.20~2.30	
		090208-HMP																									0.08~0.23	0.40~2.30	
		110202-HMP																									0.03~0.15	0.10~1.50	
		110204-HMP	●					●		●	●	●	●														0.06~0.19	0.20~2.50	
		110208-HMP																										0.09~0.26	0.40~2.50
		16T304-HMP	●																									0.08~0.23	0.30~3.00
Medium	MP	TCMT	110202-MP																								0.03~0.12	0.20~1.50	
		110204-MP																									0.05~0.15	0.20~15.0	
		110208-MP																										0.10~0.28	0.25~2.00
		16T304-MP	●	●	●	●	●	●	●	●	●	●						●	●	●	●	●					0.08~0.20	0.30~2.50	
		16T308-MP	●	●	●	●	●	●	●	●	●	●						●	●	●	●	●					0.10~0.30	0.50~2.50	
		16T312-MP																										0.20~0.40	0.50~2.50

⊙ Cutting edge geometry A38 ~ A43
⊙ Recommended chip breaker B04 ~ B11
⊙ Code system B18 ~ B19
● : Stock item

Available tool holders			
Designation	Page	Designation	Page
STACR/L	B126,178	STTCR/L	B127,174
STFCR/L	B126,173	STWCR/L	B174
STGCR/L	B127		





## TC ○○



**Triangular 60° Positive**  
Relief Angle : 7°

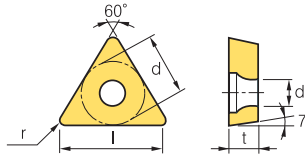

Dimensions(mm)			
Size	d	t	d1
09	5.56	2.38	2.5
11	6.35	2.38	2.8
16	9.523	3.97	4.4

Workpiece	Machining types																						
	P	M	K	N	S	H	NC3010	NC3215	NC3120	NC3220	NC3225	NC3030	NC5330	NC9020	NC9025	NC6205	NC6210	NC6215	PC5300	PC5400	PC8105	PC8110	PC9030
Steel	●	●	●	●	●	●	●	●	●	●	●	●	●	●	●	●	●	●	●	●	●	●	●
Stainless steel	●	●	●	●	●	●	●	●	●	●	●	●	●	●	●	●	●	●	●	●	●	●	●
Cast iron	●	●	●	●	●	●	●	●	●	●	●	●	●	●	●	●	●	●	●	●	●	●	●
Non-ferrous metal	●	●	●	●	●	●	●	●	●	●	●	●	●	●	●	●	●	●	●	●	●	●	●
Heat resistant alloy, Titanium alloy	●	●	●	●	●	●	●	●	●	●	●	●	●	●	●	●	●	●	●	●	●	●	●
Hardened steel	●	●	●	●	●	●	●	●	●	●	●	●	●	●	●	●	●	●	●	●	●	●	●

Inserts	Designation	Cermet		Coated												Uncoated		Cutting Condition									
		CN1500	CN2000	CN2500	CC1500	CC2500	NC3010	NC3215	NC3120	NC3220	NC3225	NC3030	NC5330	NC9020	NC9025	NC6205	NC6210	NC6215	PC5300	PC5400	PC8105	PC8110	PC9030	H01	H05	fn (mm/rev)	ap (mm)
Medium	C25	TCMT 090204-C25	●	●	●	●	●	●	●	●	●	●	●	●	●	●	●	●	●	●	●	●	●	●	●	0.06~0.18	0.40~2.50
		TCMT 090208-C25	●	●	●	●	●	●	●	●	●	●	●	●	●	●	●	●	●	●	●	●	●	●	●	0.08~0.25	0.80~2.50
		TCMT 110202-C25	●	●	●	●	●	●	●	●	●	●	●	●	●	●	●	●	●	●	●	●	●	●	●	0.04~0.12	0.40~2.00
		TCMT 110204-C25	●	●	●	●	●	●	●	●	●	●	●	●	●	●	●	●	●	●	●	●	●	●	●	0.06~0.20	0.60~2.50
		TCMT 110208-C25	●	●	●	●	●	●	●	●	●	●	●	●	●	●	●	●	●	●	●	●	●	●	●	0.08~0.25	0.80~2.50
		TCMT 16T304-C25	●	●	●	●	●	●	●	●	●	●	●	●	●	●	●	●	●	●	●	●	●	●	●	0.08~0.28	0.80~3.00
		TCMT 16T308-C25	●	●	●	●	●	●	●	●	●	●	●	●	●	●	●	●	●	●	●	●	●	●	●	0.10~0.30	1.00~3.00

Cutting edge geometry A38 ~ A43  
 Recommended chip breaker B04 ~ B11  
 Code system B18 ~ B19  
 ● : Stock item

Available tool holders			
Designation	Page	Designation	Page
STACR/L	B126,178	STTCR/L	B127,174
STFCR/L	B126,173	STWCR/L	B174
STGCR/L	B127		

## TO ○○



**Triangular 60° Positive**  
Relief Angle : 8°

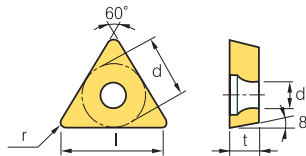

Dimensions(mm)			
Size	d	t	d1
06	3.97	1.59	2.15
09	5.56	2.38	2.8
14	8.2	3.0	3.8

Workpiece	Machining types																								
	P	M	K	N	S	H	NC3010	NC3215	NC3120	NC3220	NC3225	NC3030	NC5330	NC9020	NC9025	NC6205	NC6210	NC6215	PC5300	PC5400	PC8105	PC8110	PC8115	H01	H05
Steel	●	●	●	●	●	●	●	●	●	●	●	●	●	●	●	●	●	●	●	●	●	●	●	●	●
Stainless steel	●	●	●	●	●	●	●	●	●	●	●	●	●	●	●	●	●	●	●	●	●	●	●	●	●
Cast iron	●	●	●	●	●	●	●	●	●	●	●	●	●	●	●	●	●	●	●	●	●	●	●	●	●
Non-ferrous metal	●	●	●	●	●	●	●	●	●	●	●	●	●	●	●	●	●	●	●	●	●	●	●	●	●
Heat resistant alloy, Titanium alloy	●	●	●	●	●	●	●	●	●	●	●	●	●	●	●	●	●	●	●	●	●	●	●	●	●
Hardened steel	●	●	●	●	●	●	●	●	●	●	●	●	●	●	●	●	●	●	●	●	●	●	●	●	●

Inserts	Designation	Cermet		Coated												Uncoated		Cutting Condition										
		CN1500	CN2000	CN2500	CC1500	CC2500	NC3010	NC3215	NC3120	NC3220	NC3225	NC3030	NC5330	NC9020	NC9025	NC6205	NC6210	NC6215	PC5300	PC5400	PC8105	PC8110	PC8115	H01	H05	fn (mm/rev)	ap (mm)	
Medium to finishing	TOEH	TOEH 060102L																								0.05~0.17	0.10~1.50	
		TOEH 090204L																									0.05~0.20	0.30~2.50
		TOEH 140304L	●																								0.05~0.25	0.30~2.50

Cutting edge geometry A38 ~ A43  
 Recommended chip breaker B04 ~ B11  
 Code system B18 ~ B19  
 ● : Stock item



# B Turning Insert (Positive)

## TP ○○

 Triangular **60° Positive**  
Relief Angle : 11°

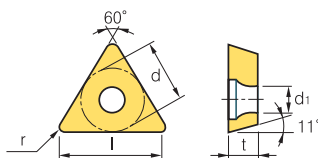

Dimensions(mm)			
Size	d	t	d1
08	4.76	2.38	2.3
09	5.56	2.38	-
11	6.35	2.38~3.18	3.4
16	9.525	3.18~4.76	4.4
22	12.7	4.76	-
27	15.875	4.76~6.35	-

Workpiece	Material	Code	Machining types															
			●	●	●	●	●	●	●	●	●	●	●	●	●	●	●	●
Steel	P		●	●	●	●	●	●	●	●	●	●	●	●	●	●	●	
Stainless steel	M																	
Cast iron	K		●	●	●	●	●	●	●	●	●	●	●	●	●	●		
Non-ferrous metal	N																	
Heat resistant alloy, Titanium alloy	S																	
Hardened steel	H																	

● Continuous cutting  
 ● General cutting  
 ● Interrupted cutting

Inserts	Designation	Cermet		Coated		Coated										Uncoated		Cutting Condition										
		CN1500	CN2000	CN2500	CC1500	CC2500	NC3010	NC3215	NC3120	NC3220	NC3225	NC3030	NC5330	NC9020	NC9025	NC6205	NC6210	NC6215	PC5300	PC5400	PC8105	PC8110	PC8115	H01	H05	fn (mm/rev)	ap (mm)	
Finishing	TPGH	080202L		●																						0.01~0.12	0.06~1.70	
		080204L	●	●																							0.01~0.15	0.08~1.70
		110202L																									0.01~0.12	0.06~2.00
		110204L																									0.01~0.15	0.08~2.00
Medium to finishing	TPGN	090204																								0.07~0.20	0.70~2.00	
		110302																								0.05~0.15	0.50~2.00	
		110304									●													●		0.07~0.20	0.70~3.00	
		110308									●													●		0.10~0.25	1.00~3.00	
		160302																								0.05~0.18	1.00~5.00	
		160304									●	●												●		0.07~0.20	1.00~5.00	
		160308									●	●												●		0.10~0.25	1.00~5.00	
		160310																								0.10~0.25	1.00~5.00	
		160312										●														0.15~0.30	1.00~5.00	
		160316										●														0.15~0.30	1.00~5.00	
		160404																								0.07~0.20	1.00~5.00	
		220404										●														0.07~0.20	1.50~7.00	
		220408										●														0.10~0.25	1.50~7.00	
		220412										●														0.15~0.30	1.50~7.00	
		220430																								0.30~0.45	1.50~7.00	
220440																								0.30~0.50	1.50~7.00			
270408																								0.15~0.25	3.00~8.00			
270608																								0.15~0.25	3.00~8.00			
Finishing	TPGR	110302-F																							0.05~0.15	0.10~1.50		
		110304-F																							0.05~0.20	0.30~1.50		
		160304-F																							0.08~0.25	0.50~2.00		
Medium	TPGR	110308-M																						0.13~0.30	1.00~3.00			
		160308-M																						0.13~0.30	1.00~5.00			

 Cutting edge geometry A38 ~ A43  
  Recommended chip breaker B04 ~ B11  
  Code system B18 ~ B19  
 ● : Stock item

Available tool holders			
Designation	Page	Designation	Page
STFPR/L	B147	STUPR/L	B150
CTFPR/L	B115	CTGPR/L	B115





# B Turning Insert (Positive)

## TP ○○

 Triangular **60° Positive**  
Relief Angle : 11°

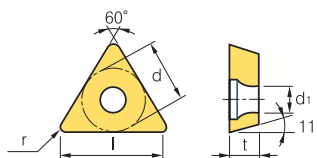

Dimensions(mm)			
Size	d	t	d1
09	5.56	3.18	-
11	6.35	3.18	3.4
16	9.525	3.18~4.76	4.4
22	12.7	4.76	-
33	19.05	6.35	-

Workpiece	Material										Machining types				
	Steel	Stainless steel	Cast iron	Non-ferrous metal	Heat resistant alloy, Titanium alloy	Hardened steel	P	M	K	N	S	H	Continuous cutting	General cutting	Interrupted cutting
Steel	●	●	●	●	●	●	●	●	●	●	●	●	●	●	●
Stainless steel	●	●	●	●	●	●	●	●	●	●	●	●	●	●	●
Cast iron	●	●	●	●	●	●	●	●	●	●	●	●	●	●	●
Non-ferrous metal	●	●	●	●	●	●	●	●	●	●	●	●	●	●	●
Heat resistant alloy, Titanium alloy	●	●	●	●	●	●	●	●	●	●	●	●	●	●	●
Hardened steel	●	●	●	●	●	●	●	●	●	●	●	●	●	●	●

Inserts	Designation	Cermet		Coated		Coated										Uncoated		Cutting Condition										
		CN1500	CN2000	CN2500	CC1500	CC2500	NC3010	NC3215	NC3120	NC3220	NC3225	NC3030	NC5330	NC9020	NC9025	NC6205	NC6210	NC6215	PC5300	PC5400	PC8105	PC8110	PC8115	H01	H05	fn (mm/rev)	ap (mm)	
Medium	M	TPMR	110304-M																							0.10~0.25	0.70~3.00	
		110308-M				●		●																		0.13~0.30	1.00~3.00	
		160304-M									●																0.10~0.25	1.00~5.00
		160308-M									●		●														0.13~0.30	1.00~5.00
		160312-M										●															0.15~0.35	1.00~5.00
		220408-M										●																0.13~0.30
Medium to finishing	TPUN	090308																								0.10~0.30	0.50~2.00	
		110208																								0.15~0.40	1.00~3.00	
		110304																								0.10~0.30	1.00~3.00	
		110308																								0.15~0.40	1.00~3.00	
		160304									●		●														0.10~0.30	1.00~5.00
		160308									●		●														0.15~0.40	1.00~5.00
		160312											●														0.20~0.50	1.50~5.00
		220404																									0.10~0.30	1.50~7.00
		220408										●		●													0.15~0.40	1.50~7.00
		220412																									0.20~0.50	1.50~7.00
		330620																									0.30~0.70	3.00~10.00
		160308TN																									0.15~0.40	1.00~5.00
		160312TN																									0.20~0.50	1.50~5.00
220412TN																									0.20~0.50	1.50~7.00		
Finishing	VL	TPMT	110304-VL	●		●																				0.05~0.15	0.10~1.30	
Finishing	VF	TPMT	110304-VF		●					●	●	●	●	●					●							0.05~0.20	0.30~1.50	
		110308-VF									●								●							0.10~0.25	0.30~1.50	
		160404-VF																								0.05~0.20	0.30~2.00	
		160408-VF																								0.10~0.25	0.30~2.00	
Medium to finishing	MP	TPMT	110304-MP	●		●	●	●											●	●						0.05~0.20	0.20~1.50	

Cutting edge geometry A38 ~ A43    
 Recommended chip breaker B04 ~ B11    
 Code system B18 ~ B19    
 ● : Stock item

Available tool holders			
Designation	Page	Designation	Page
STFPR/L	B147	STUPR/L	B150
CTFPR/L	B115	CTGPR/L	B115









# VC

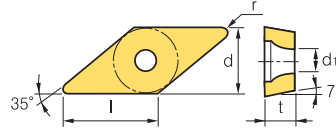

Dimensions(mm)			
Size	d	t	d1
11	6.35	3.18	2.8~3.4
16	9.525	4.76	4.4

**Rhombic 35° Positive**  
Relief Angle : 7°

Workpiece	Material Compatibility																Machining types		
	Steel	Stainless steel	Cast iron	Non-ferrous metal	Heat resistant alloy, Titanium alloy	Hardened steel	P	M	K	N	S	H	●	⊙	⊘	⊚	⊛	⊜	
Steel	●	●	●	●	●	●	●	●	●	●	●	●	●	●	●	●	●	●	●
Stainless steel	●	●	●	●	●	●	●	●	●	●	●	●	●	●	●	●	●	●	●
Cast iron	●	●	●	●	●	●	●	●	●	●	●	●	●	●	●	●	●	●	●
Non-ferrous metal	●	●	●	●	●	●	●	●	●	●	●	●	●	●	●	●	●	●	●
Heat resistant alloy, Titanium alloy	●	●	●	●	●	●	●	●	●	●	●	●	●	●	●	●	●	●	●
Hardened steel	●	●	●	●	●	●	●	●	●	●	●	●	●	●	●	●	●	●	●

Inserts	Designation	Cermet		Coated		Coated											Uncoated		Cutting Condition										
		CN1500	CN2000	CN2500	CC1500	CC2500	NC3010	NC3215	NC3120	NC3220	NC3225	NC3030	NC5330	NC9020	NC9025	NC6210	NC6215	PC5300	PC5400	PC8105	PC8110	PC8115	PC9030	HO1	HO5	fn (mm/rev)	ap (mm)		
<b>Finishing (High precision)</b> 	VCET	1103005MFR-KF																									0.01~0.06	0.04~1.30	
		110301MFR-KF																										0.02~0.08	0.05~1.50
		110302MFR-KF																										0.03~0.11	0.06~1.70
		1103005MFL-KF																										0.01~0.06	0.04~1.30
		110301MFL-KF																										0.02~0.08	0.05~1.50
		110302MFL-KF																										0.03~0.11	0.06~1.70
<b>Medium to finishing (High precision)</b> 	VCET	1103005MFR-KM																									0.02~0.08	0.05~1.50	
		110301MFR-KM																									0.03~0.11	0.06~1.70	
		110302MFR-KM																										0.04~0.15	0.08~2.00
		1103005MFL-KM																										0.02~0.08	0.05~1.50
		110301MFL-KM																										0.03~0.11	0.06~1.70
		110302MFL-KM																										0.04~0.15	0.08~2.00
<b>Finishing</b> 	VCGT	110302-HFP																									0.02~0.18	0.10~1.00	
		110304-HFP																									0.03~0.18	0.15~1.20	
		110308-HFP																										0.04~0.23	0.20~1.20
		160404-HFP									●	●															●	0.04~0.20	0.15~1.50
		160408-HFP									●	●															●	0.05~0.25	0.20~1.50
<b>Finishing</b> 	VCGT	110301-VP1																								●	0.02~0.15	0.05~0.50	
		110302-VP1																								●	0.02~0.18	0.10~1.00	
		110304-VP1																								●	0.03~0.18	0.15~1.20	
<b>Finishing (High precision)</b> 	VCGT	110301MFN-VP1																									●	0.02~0.15	0.05~0.50
		110302MFN-VP1																									●	0.02~0.18	0.10~1.00
		110304MFN-VP1																									●	0.03~0.18	0.15~1.20
<b>Finishing</b> 	VCGT	1103003R-KF																									0.01~0.06	0.04~1.30	
		110301R-KF																									0.02~0.08	0.05~1.50	
		110302R-KF																									●	0.03~0.13	0.06~1.70
		1103003L-KF																										0.01~0.06	0.04~1.30
		110301L-KF																										0.02~0.08	0.05~1.50
		110302L-KF																										0.03~0.13	0.06~1.70

🔄 Cutting edge geometry A38 ~ A43
🔄 Recommended chip breaker B04 ~ B11
🔄 Code system B18 ~ B19
● : Stock item

Available tool holders			
Designation	Page	Designation	Page
SVJCR/L	B128,148,178	SVQCR/L	B148
SVVCN	B129	SVUCR/L	B144



# B Turning Insert (Positive)

VC ○ ○



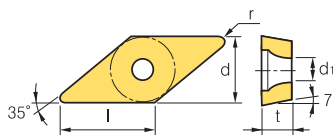



 Rhombic **35° Positive**  
Relief Angle : 7°



Dimensions(mm)			
Size	d	t	d1
08	4.76	2.38	2.3
11	6.35	3.18	2.8~3.4
16	9.525	4.76	4.4

Workpiece	Machining types											
	P	M	K	N	S	H						
Steel	●	●	●	●	●	●	●	●	●	●	●	●
Stainless steel	●	●	●	●	●	●	●	●	●	●	●	●
Cast iron	●	●	●	●	●	●	●	●	●	●	●	●
Non-ferrous metal	●	●	●	●	●	●	●	●	●	●	●	●
Heat resistant alloy, Titanium alloy	●	●	●	●	●	●	●	●	●	●	●	●
Hardened steel	●	●	●	●	●	●	●	●	●	●	●	●

● Continuous cutting  
● General cutting  
✦ Interrupted cutting

Inserts	Designation	Cermet		Coated		Coated										Uncoated		Cutting Condition											
		CN1500	CN2000	CN2500	CC1500	CC2500	NC3010	NC3215	NC3120	NC3220	NC3225	NC3030	NC5330	NC9020	NC9025	NC6205	NC6210	NC6215	PC5300	PC5400	PC8105	PC8110	PC8115	H01	H05	fn (mm/rev)	ap (mm)		
Finishing 	VCGT	1103003R-KM																									0.01~0.06	0.04~1.30	
		110301R-KM																										0.02~0.08	0.05~1.50
		110302R-KM																						●				0.03~0.13	0.06~1.70
		1103003L-KM																										0.01~0.06	0.04~1.30
		110301L-KM																										0.02~0.08	0.05~1.50
		110302L-KM																										0.03~0.13	0.06~1.70
Finishing (High precision) 	VCGX	120300MFR-VP1																									0.02~0.10	0.05~0.50	
		120301MFR-VP1																									0.02~0.15	0.05~0.50	
		120302MFR-VP1																									0.02~0.18	0.10~1.00	
Finishing 	VCMT	110302-HFP																									0.02~0.18	0.10~1.00	
		110304-HFP																									0.03~0.18	0.15~1.20	
		110308-HFP																									0.04~0.23	0.20~1.20	
		160404-HFP																									0.04~0.20	0.15~1.50	
		160408-HFP																									0.05~0.25	0.20~1.50	
Finishing 	VCMT	080202-VF					●																				0.05~0.20	0.30~1.00	
		080204-VF										●															0.10~0.25	0.30~1.00	
		110304-VF						●		●	●																0.03~0.18	0.15~1.20	
		160404-VF		●				●		●	●	●											●				0.04~0.20	0.15~1.50	
Finishing (Mild steel) 	VCMT	160404-VL					●	●		●											●	●				0.05~0.20	0.30~1.50		
		160408-VL					●	●		●	●										●	●				0.05~0.20	0.30~1.50		
		160412-VL																				●	●				0.10~0.25	0.30~1.50	
Medium to finishing 	VCMT	160404-HMP					●	●	●	●	●										●	●				0.10~0.25	0.30~2.60		
		160408-HMP							●	●	●	●										●	●				0.13~0.33	0.60~2.60	
Medium to finishing 	VCMT	160404-MP					●			●											●	●				0.08~0.18	0.30~2.00		
		160408-MP					●			●												●	●				0.10~0.23	0.50~2.30	
		160412-MP																				●	●				0.10~0.33	0.50~2.30	

 Cutting edge geometry A38 ~ A43  
  Recommended chip breaker B04 ~ B11  
  Code system B18 ~ B19  
 ● : Stock item

Available tool holders			
Designation	Page	Designation	Page
SVJCR/L	B128,148,178	SVQCR/L	B148
SVVCN	B129	SVUCR/L	B144



# VP ○○

Dimensions(mm)			
Size	d	t	d1
08	6.35	2.38	2.3
11	6.35	3.18	2.8

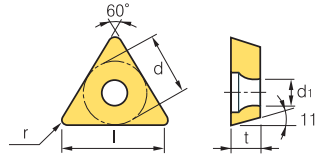

**Triangular 60° Positive**  
Relief Angle : 11°

Workpiece	Machining types															
	P	M	K	N	S	H										
Steel	●	●	●	●	●	●	●	●	●	●	●	●	●	●	●	●
Stainless steel	●	●	●	●	●	●	●	●	●	●	●	●	●	●	●	●
Cast iron	●	●	●	●	●	●	●	●	●	●	●	●	●	●	●	●
Non-ferrous metal	●	●	●	●	●	●	●	●	●	●	●	●	●	●	●	●
Heat resistant alloy, Titanium alloy	●	●	●	●	●	●	●	●	●	●	●	●	●	●	●	●
Hardened steel	●	●	●	●	●	●	●	●	●	●	●	●	●	●	●	●

● Continuous cutting  
● General cutting  
● Interrupted cutting

Inserts	Designation	Cermet		Coated		Coated										Uncoated		Cutting Condition											
		CN1500	CN2000	CN2500	CC1500	CC2500	NC3010	NC3215	NC3120	NC3220	NC3225	NC3030	NC5330	NC9020	NC9025	NC6205	NC6210	NC6215	PC5300	PC5400	PC8105	PC8110	PC8115	H01	H05	fn (mm/rev)	ap (mm)		
Finishing (High precision) 	VPET	0802005MFR-KF																									0.01~0.12	0.05~0.50	
		080201MFR-KF																				●					0.02~0.15	0.05~0.50	
		080202MFR-KF																				●					0.02~0.18	0.10~1.00	
		0802005MFL-KF																										0.01~0.12	0.05~0.50
		080201MFL-KF																										0.02~0.15	0.05~0.50
		080202MFL-KF																										0.02~0.18	0.10~1.00
Medium to finishing (High precision) 	VPET	0802005MFR-KM																									0.01~0.12	0.05~0.50	
		080201MFR-KM																				●					0.02~0.15	0.05~0.50	
		080202MFR-KM																				●					0.02~0.18	0.10~1.00	
		0802005MFL-KM																										0.01~0.12	0.05~0.50
		080201MFL-KM																										0.02~0.15	0.05~0.50
		080202MFL-KM																										0.02~0.18	0.10~1.00
Finishing 	VPGT	110301-VP1																		●	●	●	●	●			0.02~0.15	0.05~0.50	
		110302-VP1																		●	●	●	●	●			0.02~0.18	0.10~1.00	
		110304-VP1																		●	●	●	●	●			0.03~0.18	0.15~1.20	
Finishing (High precision) 	VPGT	110301MFN-VP1																				●					0.02~0.15	0.05~0.50	
		110302MFN-VP1																					●				0.02~0.18	0.10~1.00	
		110304MFN-VP1																						●			0.03~0.18	0.15~1.20	

➡ Cutting edge geometry A38 ~ A43    ➡ Recommended chip breaker B04 ~ B11    ➡ Code system B18 ~ B19    ● : Stock item

Available tool holders			
Designation	Page	Designation	Page
SVABR/L	B127	SVVBN	B128
SVJBR/L	B128, 178		

# B Turning Insert (Positive)

## WB



**Trigon 80° Positive**  
Relief Angle : 5°

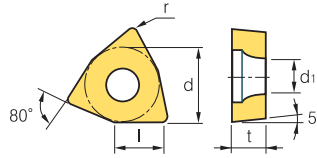

Dimensions(mm)			
Size	d	t	d1
<b>02</b>	3.97	1.59	2.2
<b>S3</b>	4.76	2.38	2.4

Workpiece	Machining types																								
	P	M	K	N	S	H	NC3010	NC3215	NC3120	NC3220	NC3225	NC3030	NC5330	NC9020	NC9025	NC6205	NC6210	NC6215	PC5300	PC5400	PC8105	PC8110	PC9030	H01	H05
Steel	●	●	●	●	●	●	●	●	●	●	●	●	●	●	●	●	●	●	●	●	●	●	●	●	●
Stainless steel	●	●	●	●	●	●	●	●	●	●	●	●	●	●	●	●	●	●	●	●	●	●	●	●	●
Cast iron	●	●	●	●	●	●	●	●	●	●	●	●	●	●	●	●	●	●	●	●	●	●	●	●	●
Non-ferrous metal	●	●	●	●	●	●	●	●	●	●	●	●	●	●	●	●	●	●	●	●	●	●	●	●	●
Heat resistant alloy, Titanium alloy	●	●	●	●	●	●	●	●	●	●	●	●	●	●	●	●	●	●	●	●	●	●	●	●	●
Hardened steel	●	●	●	●	●	●	●	●	●	●	●	●	●	●	●	●	●	●	●	●	●	●	●	●	●

Inserts	Designation	Cermet		Coated		Coated													Uncoated		Cutting Condition							
		CN1500	CN2000	CN2500	CC1500	CC2500	NC3010	NC3215	NC3120	NC3220	NC3225	NC3030	NC5330	NC9020	NC9025	NC6205	NC6210	NC6215	PC5300	PC5400	PC8105	PC8110	PC9030	H01	H05	fn (mm/rev)	ap (mm)	
Medium to finishing	WBGT 020102R																										0.01~0.05	0.10~0.30
	S30204R																										0.01~0.10	0.10~0.50
	020102L			●																			●	●			0.01~0.08	0.10~0.40
	S30202L			●																							0.01~0.08	0.10~0.40
	S30204L																										0.01~0.10	0.10~0.50

➔ Cutting edge geometry A38 ~ A43   ➔ Recommended chip breaker B04 ~ B11   ➔ Code system B18 ~ B19   ● : Stock item

Available tool holders			
Designation	Page	Designation	Page
SWUBR/L	B150		

## WC



**Trigon 80° Positive**  
Relief Angle : 7°

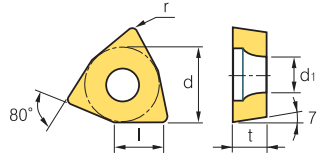

Dimensions(mm)			
Size	d	t	d1
<b>08</b>	12.7	4.76	5.5

Workpiece	Machining types																								
	P	M	K	N	S	H	NC3010	NC3215	NC3120	NC3220	NC3225	NC3030	NC5330	NC9020	NC9025	NC6205	NC6210	NC6215	PC5300	PC5400	PC8105	PC8110	PC8115	H01	H05
Steel	●	●	●	●	●	●	●	●	●	●	●	●	●	●	●	●	●	●	●	●	●	●	●	●	●
Stainless steel	●	●	●	●	●	●	●	●	●	●	●	●	●	●	●	●	●	●	●	●	●	●	●	●	●
Cast iron	●	●	●	●	●	●	●	●	●	●	●	●	●	●	●	●	●	●	●	●	●	●	●	●	●
Non-ferrous metal	●	●	●	●	●	●	●	●	●	●	●	●	●	●	●	●	●	●	●	●	●	●	●	●	●
Heat resistant alloy, Titanium alloy	●	●	●	●	●	●	●	●	●	●	●	●	●	●	●	●	●	●	●	●	●	●	●	●	●
Hardened steel	●	●	●	●	●	●	●	●	●	●	●	●	●	●	●	●	●	●	●	●	●	●	●	●	●

Inserts	Designation	Cermet		Coated		Coated													Uncoated		Cutting Condition							
		CN1500	CN2000	CN2500	CC1500	CC2500	NC3010	NC3215	NC3120	NC3220	NC3225	NC3030	NC5330	NC9020	NC9025	NC6205	NC6210	NC6215	PC5300	PC5400	PC8105	PC8110	PC8115	H01	H05	fn (mm/rev)	ap (mm)	
Medium to finishing	WCGT 080408-C05																										0.08~0.30	0.20~2.70

➔ Cutting edge geometry A38 ~ A43   ➔ Recommended chip breaker B04 ~ B11   ➔ Code system B18 ~ B19   ● : Stock item

Available tool holders			
Designation	Page	Designation	Page
SWACR/L	B129	SWLCR/L	B149



## Technical Information for Aluminum

### ▶ AK special chip breaker for aluminum

- ▶ Unique and 3-dimensional rake angle controls chip breaking and chip flow ensuring longer tool life and reducing cutting load
- ▶ High rake angle at cutting edge part reduces cutting load to increase tool life.
- ▶ Buffed finish on top face controls chip flow reducing built-up edge



- 1 High rake angle & tabby pattern chip pocket - Low cutting load
- 2 Unique rake angle design - Effective chip breaking and good chip flow
- 3 Unique and 3-dimensional top face - Longer tool life & Excellent surface roughness
- 4 Tabby pattern & Sharp cutting edge - Distributing cutting load, long tool life
- 5 Buffed on top face - Excellent machining, Reducing built-up edge, Excellent chip flow

### ▶ AR special chip breaker for aluminum

- ▶ AR chip breaker ensures reliability and good cutting performance at high feed, speed and interrupted machining



- 1 Flat corner cutting edge improved productivity at high feed machining and ensures good surface roughness and reliability owing to strong cutting edge
- 2 Specially buffed on top face controls chip flow reducing built-up edge
- 3 KORLOY's own technology applied for cutting edge and corner shape controlling chip flow ensures longer tool life
- 4 KORLOY special chip breaker design controls chip flow at high speed machining

### ▶ AK and AR chip breaker specially developed for aluminum

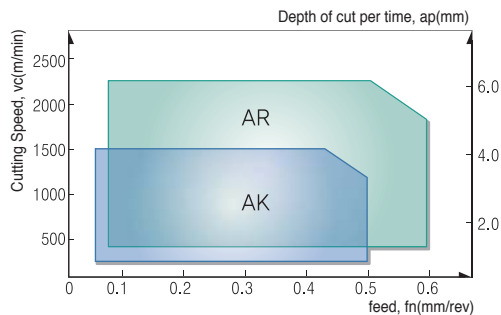

	Recommendation range	Grades
AK	ap=0.1~5.0mm fn=0.03~0.5mm/rev	H01(Uncoated cemented carbides K10~K20) ND1000(Diamond coating)
AR	ap=0.5~6.0mm fn=0.05~0.6mm/rev	H01(Uncoated cemented carbides K10~K20) ND1000(Diamond coating) PD1000(DLC coating)

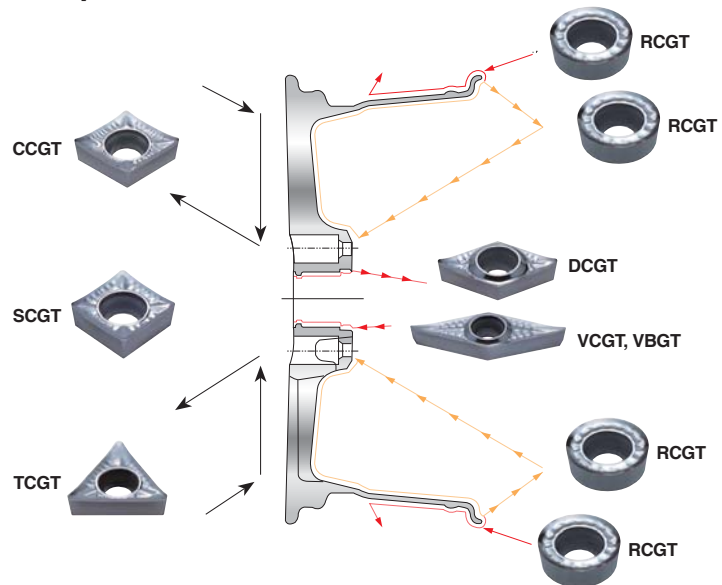

### ▶ Features of H01 and cutting conditions

- Useful for aluminum and alloyed steel machining
- Buffed on top face reduced built-up edge
- 3-dimensional design reduced cutting load and shows good performance at high feed and speed machining

Workpiece		Hardness(HB)	kc(MPa)	vc(m/min)	fn(mm/rev)
Aluminum alloy (forged)	before heat treatment	50 ~ 70	500 ~ 600	1000 ~ 2500	0.1 ~ 0.6
	after heat treatment	90 ~ 110	700 ~ 900	300 ~ 1000	0.1 ~ 0.5
Aluminum alloy (cast)	before heat treatment	70 ~ 80	700 ~ 800	300 ~ 1000	0.1 ~ 0.6
	after heat treatment	80 ~ 100	800 ~ 950	200 ~ 600	0.1 ~ 0.4
Copper alloy	-	90 ~ 110	700	250 ~ 600	0.1 ~ 0.5
Non-ferrous metal, etc	-	100	1700	150 ~ 300	0.1 ~ 0.6

# B Aluminum Insert (Positive)

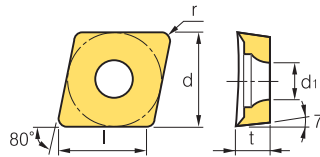

CC ○ ○

 Rhombic **80° Positive**  
Relief Angle : 7°



Dimensions(mm)			
Size	d	t	d1
06	6.35	2.38	2.8
09	9.525	3.97	4.4
12	12.7	4.76	5.5

Workpiece	Steel	P					Machining types
	Stainless steel	M					
Cast iron	K						● Continuous cutting
Non-ferrous metal	N	⊕	⊕	●	⊕	⊕	● General cutting
Heat resistant alloy, Titanium alloy	S						⊕ Interrupted cutting
Hardened steel	H						

Inserts	Designation	Coated			Uncoated		Cutting Condition	
		PC5040	PC130	PD1000	H01	H10	fn (mm/rev)	ap (mm)
<b>AK</b> 	CCGT 060202-AK	●			●		0.01~0.12	0.05~3.00
	060204-AK	●			●		0.02~0.15	0.10~3.00
	060208-AK				●		0.02~0.20	0.10~4.00
	09T302-AK	●			●		0.02~0.20	0.05~3.00
	09T304-AK	●	●		●		0.02~0.30	0.10~5.00
	09T308-AK	●			●		0.03~0.50	0.10~5.00
	120402-AK				●		0.02~0.30	0.05~4.00
	120404-AK	●	●		●	●	0.03~0.50	0.10~5.00
	120408-AK				●		0.04~0.80	0.10~5.50
<b>AR</b> 	CCGT 060202-AR				●		0.02~0.30	0.30~4.00
	060204-AR						0.03~0.35	0.50~4.50
	060208-AR						0.04~0.50	0.50~4.50
	09T302-AR						0.03~0.45	0.30~4.00
	09T304-AR				●		0.04~0.50	0.50~4.50
	09T308-AR				●		0.05~0.60	0.50~6.00
	120402-AR				●		0.04~0.50	0.30~5.00
	120404-AR				●	●	0.05~0.60	0.50~6.00
	120408-AR				●		0.06~0.65	0.50~6.00
120412-AR						0.08~0.70	0.50~6.50	

 Cutting edge geometry A38 ~ A43  
  Recommended chip breaker B04 ~ B11  
  Code system B18 ~ B19  
 ● : Stock item

Available tool holders			
Designation	Page	Designation	Page
SCACR/L	B123, 177	SCLCR/L	B133, 144, 177





DC ○ ○

 Rhombic **55° Positive**  
Relief Angle : 7°

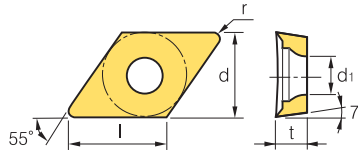

Dimensions(mm)			
Size	d	t	d1
07	6.35	2.38	2.8
11	9.525	3.97	4.4

Workpiece	Steel	P						Machining types
	Stainless steel	M						
Cast iron	K							
Non-ferrous metal	N	✦	✦	●	✦	✦		
Heat resistant alloy, Titanium alloy	S							
Hardened steel	H							

Inserts	Designation	Coated			Uncoated		Cutting Condition	
		PC5040	PC130	PD1000	H01	H10	fn (mm/rev)	ap (mm)
<b>AK</b> 	DCGT	070202-AK	●			●	0.01~0.20	0.05~3.00
		070204-AK	●	●		●	0.02~0.30	0.10~4.00
		070208-AK	●			●	0.03~0.40	0.10~4.00
		11T302-AK	●			●	0.02~0.30	0.05~4.00
		11T304-AK	●	●	●	●	0.03~0.50	0.10~5.00
		11T308-AK	●			●	0.03~0.50	0.10~5.00
		11T312-AK				●	0.04~0.60	0.15~5.00
<b>AR</b> 	DCGT	070202-AR				●	0.02~0.30	0.30~4.00
		070204-AR				●	0.03~0.40	0.50~5.00
		070208-AR				●	0.04~0.50	0.50~5.00
		11T302-AR					0.03~0.45	0.30~6.00
		11T304-AR				●	0.04~0.50	0.50~6.00
		11T308-AR				●	0.05~0.60	0.50~6.00
		11T312-AR				●	0.08~0.65	0.50~6.50

 Cutting edge geometry **A38 ~ A43**
 Recommended chip breaker **B04 ~ B11**
 Code system **B18 ~ B19**
● : Stock item

Available tool holders			
Designation	Page	Designation	Page
SDACR/L	B123	SDQCR/L	B145
SDJCR/L	B124,177	SDUCR/L	B145
SDNCN	B124,178	SDZCR/L	B146



# B Aluminum Insert (Positive)

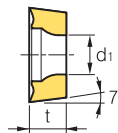

RC ○○

Round **Positive**  
Relief Angle : 7°



Dimensions(mm)			
Size	d	t	d1
06	6.0	2.38	2.8
08	8.0	3.18	3.35
10	10.0	3.18~3.97	4.4
12	12.0	4.76	4.4

Workpiece	Steel	P					Machining types
	Stainless steel	M					
Cast iron	K						● Continuous cutting
Non-ferrous metal	N	⊕	⊕	●	⊕	⊕	● General cutting
Heat resistant alloy, Titanium alloy	S						⊕ Interrupted cutting
Hardened steel	H						

Inserts	Designation	Coated			Uncoated		Cutting Condition	
		PC5040	PC130	PD1000	H01	H10	fn (mm/rev)	ap (mm)
AK 	RCGT 0602M0-AK						0.05~0.20	0.50~2.00
	0803M0-AK						0.05~0.25	0.50~2.50
	1003M0-AK				●		0.10~0.30	1.00~3.00
	10T3M0-AK				●		0.10~0.30	1.00~3.00
	1204M0-AK						0.10~0.35	1.00~3.50
AR 	RCGT 0602M0-AR						0.05~0.20	0.50~2.00
	0803M0-AR						0.05~0.25	0.50~2.50
	1003M0-AR				●		0.10~0.30	1.00~3.00
	10T3M0-AR				●		0.10~0.30	1.00~3.00
	1204M0-AR						0.10~0.35	1.00~3.50

 Cutting edge geometry A38 ~ A43  
  Recommended chip breaker B04 ~ B11  
  Code system B18 ~ B19  
 ● : Stock item

Available tool holders			
Designation	Page	Designation	Page
SRDCN	B124	SRGCR/L	B125



SC ○○

 Square **90° Positive**  
Relief Angle : 7°

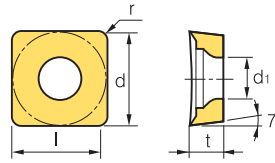

Dimensions(mm)			
Size	d	t	d1
09	9.525	3.97	4.4
12	12.7	4.76	5.5

Workpiece	Steel	<b>P</b>					Machining types
	Stainless steel	<b>M</b>					
Cast iron	<b>K</b>						<ul style="list-style-type: none"> <li>● Continuous cutting</li> <li>● General cutting</li> <li>✦ Interrupted cutting</li> </ul>
Non-ferrous metal	<b>N</b>	✦	✦	●	✦	✦	
Heat resistant alloy, Titanium alloy	<b>S</b>						
Hardened steel	<b>H</b>						

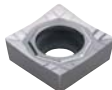
Inserts	Designation	Coated			Uncoated		Cutting Condition	
		PC5040	PC130	PD1000	H01	H10	fn (mm/rev)	ap (mm)
<b>AK</b> 	SCGT	<b>09T302-AK</b>	●				0.02~0.30	0.10~4.00
		<b>09T304-AK</b>	●			●	0.04~0.40	0.10~5.00
		<b>09T308-AK</b>				●	0.03~0.40	0.10~5.00
		<b>120404-AK</b>				●	0.03~0.50	0.10~5.00
		<b>120408-AK</b>				●	0.04~0.60	0.15~5.50
		<b>120416-AK</b>					0.04~0.60	0.15~5.50
<b>AR</b> 	SCGT	<b>09T302-AR</b>					0.03~0.40	0.50~5.00
		<b>09T304-AR</b>				●	0.04~0.50	0.50~6.00
		<b>09T308-AR</b>					0.04~0.50	0.50~6.50
		<b>120404-AR</b>				●	0.05~0.60	0.50~6.50
		<b>120408-AR</b>					0.05~0.60	0.50~7.00
		<b>120416-AR</b>					0.05~0.60	0.50~7.00

 Cutting edge geometry **A38 ~ A43**
 Recommended chip breaker **B04 ~ B11**
 Code system **B18 ~ B19**
● : Stock item

Available tool holders			
Designation	Page	Designation	Page
<b>SSBCR/L</b>	B125	<b>SSKCR/L</b>	B126
<b>SSDCN</b>	B125	<b>SSSCR/L</b>	B126



# B Aluminum Insert (Positive)

TC ○○



Triangular **60° Positive**  
Relief Angle : 7°

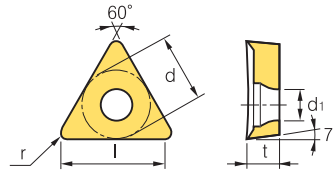

Dimensions(mm)			
Size	d	t	d1
09	5.56	2.38	2.5
11	6.35	2.38	2.8
16	9.525	3.97	4.4

Workpiece	Steel	P					Machining types
	Stainless steel	M					
Cast iron	K						● General cutting
Non-ferrous metal	N	⊕	⊕	●	⊕	⊕	⊕ Interrupted cutting
Heat resistant alloy, Titanium alloy	S						
Hardened steel	H						

Inserts	Designation	Coated			Uncoated		Cutting Condition	
		PC5040	PC130	PD1000	H01	H10	fn (mm/rev)	ap (mm)
<b>AK</b> 	TCGT	<b>090202-AK</b>					0.01~0.12	0.05~3.00
		<b>090204-AK</b>				●	0.02~0.15	0.10~4.00
		<b>110202-AK</b>	●				0.02~0.20	0.05~4.00
		<b>110204-AK</b>	●			●	0.03~0.30	0.10~4.00
		<b>110208-AK</b>					0.03~0.40	0.10~5.00
		<b>16T302-AK</b>				●	0.02~0.30	0.05~5.00
		<b>16T304-AK</b>		●		●	0.03~0.40	0.10~5.50
		<b>16T308-AK</b>				●	0.03~0.50	0.10~5.50
		<b>16T312-AK</b>					0.04~0.60	0.15~5.50
		<b>16T316-AK</b>					0.05~0.80	0.15~5.50
		<b>16T325-AK</b>					0.06~0.90	0.20~7.00
<b>AR</b> 	TCGT	<b>090202-AR</b>					0.02~0.18	0.30~3.00
		<b>090204-AR</b>				●	0.02~0.25	0.30~5.00
		<b>110202-AR</b>					0.02~0.30	0.30~4.00
		<b>110204-AR</b>				●	0.03~0.40	0.30~5.00
		<b>110208-AR</b>					0.04~0.45	0.50~6.00
		<b>16T302-AR</b>				●	0.03~0.45	0.30~5.00
		<b>16T304-AR</b>				●	0.04~0.50	0.50~6.00
		<b>16T308-AR</b>				●	0.05~0.60	0.50~6.00
		<b>16T312-AR</b>					0.06~0.65	0.50~6.00
		<b>16T316-AR</b>					0.08~0.70	0.50~6.50
		<b>16T325-AR</b>					0.10~0.10	0.80~7.00

Cutting edge geometry A38 ~ A43  
 Recommended chip breaker B04 ~ B11  
 Code system B18 ~ B19  
 ● : Stock item

Available tool holders			
Designation	Page	Designation	Page
STACR/L	B126,178	STTCR/L	B127,174
STFCR/L	B126,173	STWCR/L	B174
STGCR/L	B127		



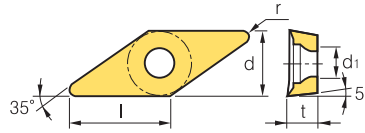

## VB ○○

 Rhombic **35° Positive**  
Relief Angle : 5°



Dimensions(mm)			
Size	d	t	d1
11	6.35	3.18	2.8
16	9.525	4.76	4.4

Workpiece	Steel	P						Machining types
	Stainless steel	M						
Cast iron	K							
Non-ferrous metal	N	●	●	●	●	✱		
Heat resistant alloy, Titanium alloy	S							
Hardened steel	H							

Inserts	Designation	Coated			Uncoated		Cutting Condition	
		PC205K	PC8110	PD1000	H01	H10	fn (mm/rev)	ap (mm)
<b>AK</b> 	VBGT 110302-AK				●		0.02~0.15	0.05~3.00
	110304-AK				●		0.02~0.15	0.10~4.00
	110308-AK						0.03~0.18	0.10~5.00
	160402-AK						0.03~0.30	0.05~4.00
	160404-AK				●		0.03~0.40	0.10~5.00
	160408-AK				●		0.03~0.50	0.10~5.00
	160412-AK						0.05~0.60	0.10~5.50
<b>AR</b> 	VBGT 110302-AR						0.02~0.35	0.30~3.00
	110304-AR						0.03~0.45	0.30~4.00
	110308-AR						0.03~0.50	0.50~6.00
	160402-AR						0.04~0.45	0.30~5.00
	160404-AR				●		0.04~0.50	0.50~6.00
	160408-AR				●		0.05~0.60	0.50~6.00
	160412-AR						0.05~0.70	0.50~6.50

 Cutting edge geometry **A38 ~ A43**
 Recommended chip breaker **B04 ~ B11**
 Code system **B18 ~ B19**
● : Stock item

Available tool holders			
Designation	Page	Designation	Page
SVABR/L	B127	SVVBN	B129
SVHBR/L	B128	SVQBR/L	B148
SVJBR/L	B128,178	SVUBR/L	B149

