

## Intelligent LED Driver(Constant Voltage)



- Housing made from SAMSUNG/COVESTRO's V0 flame retardant PC materials.
- Screwless wire-pressing flip cover design, with detachable end caps. The length of the shell can be adjusted as needed.
- Supports full-command NFC fast programming, allowing configuration via mobile app. Users can modify dimming mode, brightness range, DALI templates, and other settings through NFC, enabling data interaction with the driver.
- Two independent SELV constant voltage output channels.
- Supports DALI-2 DT6, Push DIM, and corridor light DIM modes.
- Compatible with L-Data and DALI Part 251, 252, 253.
- Supports deep dimming from 0-100%, with a minimum dimming level of 0.01%.
- Supports wired firmware update for devices.
- Complies with the EU ERP Directive on energy efficiency, with no-load power consumption < 0.5W and network standby power consumption < 0.5W.
- Innovative thermal management technology for intelligent protection of power supply lifespan.
- Overheat, over voltage, overload, short circuit protection and automatic recovery.
- Suitable for Class/II/III indoor light fixtures.
- Normal service life can reach 100,000 hours.
- 5-year warranty (Rubycon capacitor).

**Flicker Free**  
IEEE1789

**Dimmable:**  
1: 10000



**L-Data** 251/252/253



The certification icon represents undergoing certification applications only, and final certification qualification subject to actual product.

## Technical Specs

Model	LM-100-24-G1D2F			
Features	Output Type	Constant voltage		
	Dimming Interface	DALI-2 DT6, PUSH DIM		
	Output Feature	Isolation		
	Protection Grade	IP20		
	Insulation Grade	Class II (Suitable for class I/ II /III light fixtures)		
OUTPUT	Output Voltage	24V $\overline{=}$		
	Output Voltage Range	24V $\pm$ 0.5V $\overline{=}$		
	Output Current	Max. 4.17A		
	Output Power	Max. 100W		
	Output Power Range	0-100W		
	Strobe Level	High frequency exemption level		
	Dimming Range	0-100%, down to 0.01%		
	Overload Power Limitation	$\geq$ 102%		
	Ripple	$\leq$ 300mV		
	PWM Frequency	300-22000Hz		
INPUT	Input AC Voltage	220-240V~		
	Input DC Voltage	220-240V $\overline{=}$ (EMI needs to be evaluated after the lamp is equipped.)		
	Frequency	50/60Hz		
	Input Current	Max. 0.5A/230V~		
	Power Factor	PF>0.98/230V~ (at full load)		
	THD	THD<10% @ 230V~ (at full load)		
	Efficiency (Typ.)	93%		
	Inrush Current	Cold start 45A (Test twidth=300us tested under 50% Ipeak)/230Vac		
	Anti Surge	L-N: 2KV		
ENVIRONMENT	Leakage Current	Max. 0.5mA		
	Working Temperature	ta: -20 ~ 50°C tc: 80°C		
	Working Humidity	20 ~ 95%RH, non-condensing		
	Storage Temperature/Humidity	-40 ~ 80°C, 10~95%RH		
	Temperature Coefficient	$\pm$ 0.03%/°C (-20°C-50°C)		
PROTECTION	Vibration	10-500Hz, 2G 12mins/cycle, 72 min for X, Y and Z axes respectively		
	Overheat Protection	Intelligently adjust or turn off the output current if the PCB temperature $\geq$ 110°C, and recover automatically		
	Overload Protection	Automatically protect the device when the load exceeds 102% of the rated power. Automatically recover once load is reduced		
	Short Circuit Protection	Enter hiccup mode if short circuit occurs, and recover automatically		
	Overvoltage Protection	No-load voltage $\geq$ 28V; output turns off and can recover automatically.		
SAFETY & EMC	Withstand Voltage	I/P-O/P: 3750V~		
	Insulation Resistance	I/P-O/P: 100M $\Omega$ /500VDC/25°C/70%RH		
	Safety Standards	CCC	China	GB19510.1, GB19510.14, GB19510.213
		TUV	Germany	EN61347-1, EN61347-2-13, EN62493
		CB	CB Member States	IEC61347-1, IEC61347-2-13
		CE	European Union	EN61347-1, EN61347-2-13, EN62384
		EAC	Russia	IEC61347-1, IEC61347-2-13
		RCM	Australia	AS 61347-1, AS 61347-2-13
		ENEC	Europe	EN61347-1, EN61347-2-13, EN62384
	/	/	/	
	EMC Emission	/	/	/
		CCC	China	GB/T17743, GB17625.1
		CE	European Union	EN55015, EN61000-3-2, EN61000-3-3, EN61547
		EAC	Russia	IEC62493, IEC61547, EH55015
		RCM	Australia	EN55015, EN61000-3-2, EN61000-3-3, EN61547
/	/	/		
EMC Immunity	EN61000-4-2,3,4,5,6,8,11,EN61547			
ErP	Power Consumption	Networked standby	< 0.5W (After switching on/off via command)	
		No-load power consumption	< 0.5W (When the lamp is not connected)	
	Flicker/Stroboscopic Effect	IEEE1789	Meet IEEE 1789 standard/High frequency exemption level	
		CIE SVM	PstLM $\leq$ 1.0, SVM $\leq$ 0.4	
OTHERS	DF	Phase factor	DF $\geq$ 0.9	
	Weight(N.W.)	300g $\pm$ 10g		
	Dimensions	293 $\times$ 43 $\times$ 30mm(L $\times$ W $\times$ H)		

This driver is suitable for connecting LED lighting fixtures with resistor current limiting (such as LED light strips). If it is connected to a fixture with built-in constant current IC for current limiting, an instantaneous inrush current dozens of times higher will be generated, causing the driver to activate overload protection (hiccup and strobing). When placing an order, such fixtures with built-in constant current IC for current limiting (e.g., MR16 bulbs, underground lights, wall washers, constant current hard light strips, etc.) need to be specified to facilitate the burning of a special program.

## Product Size

Unit:mm

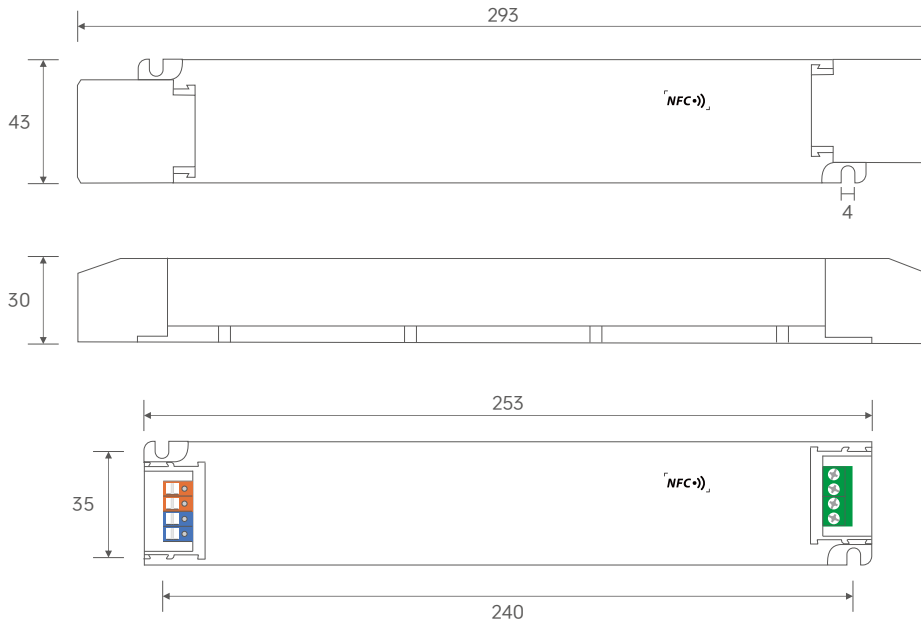

## Wiring Application Diagram

### DALI Connection Method

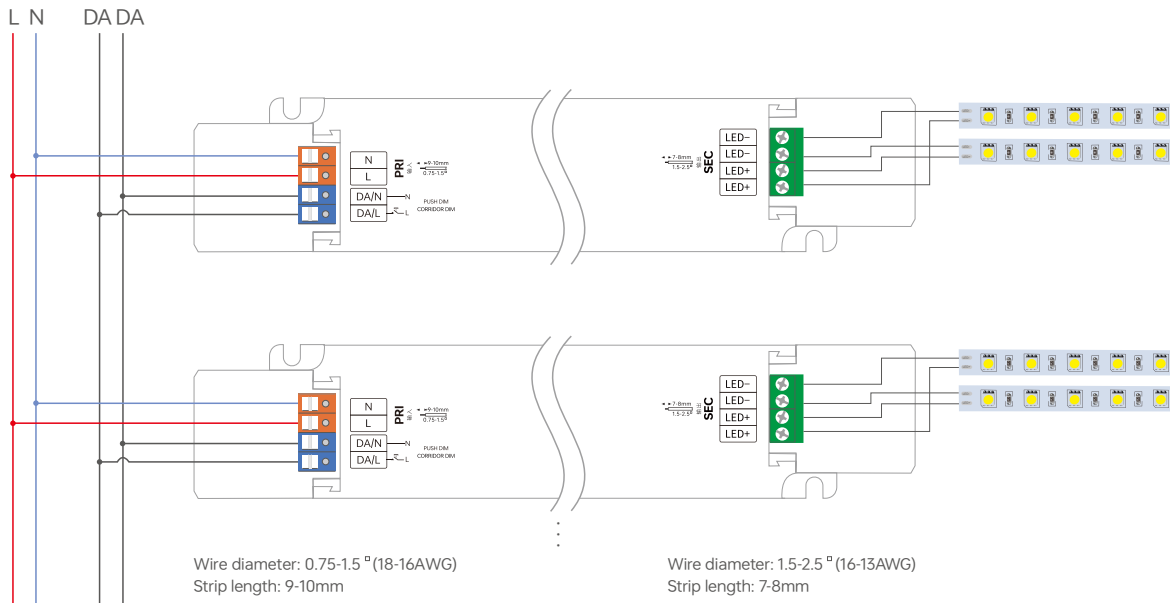

\*Power supplies of different models/wattages vary in hardware. Do not use them for dimming the same light film/light box to avoid inconsistent light activation and dimming. Recommend matching the same light film/light box with a power supply of the same model for consistent dimming.

## Switch to DALI Dimming Mode

After installation according to the wiring diagram of the DALI dimming application, the driver will automatically switch to the DALI dimming mode upon receiving any DALI command.

**PUSH DIM Connection Method**

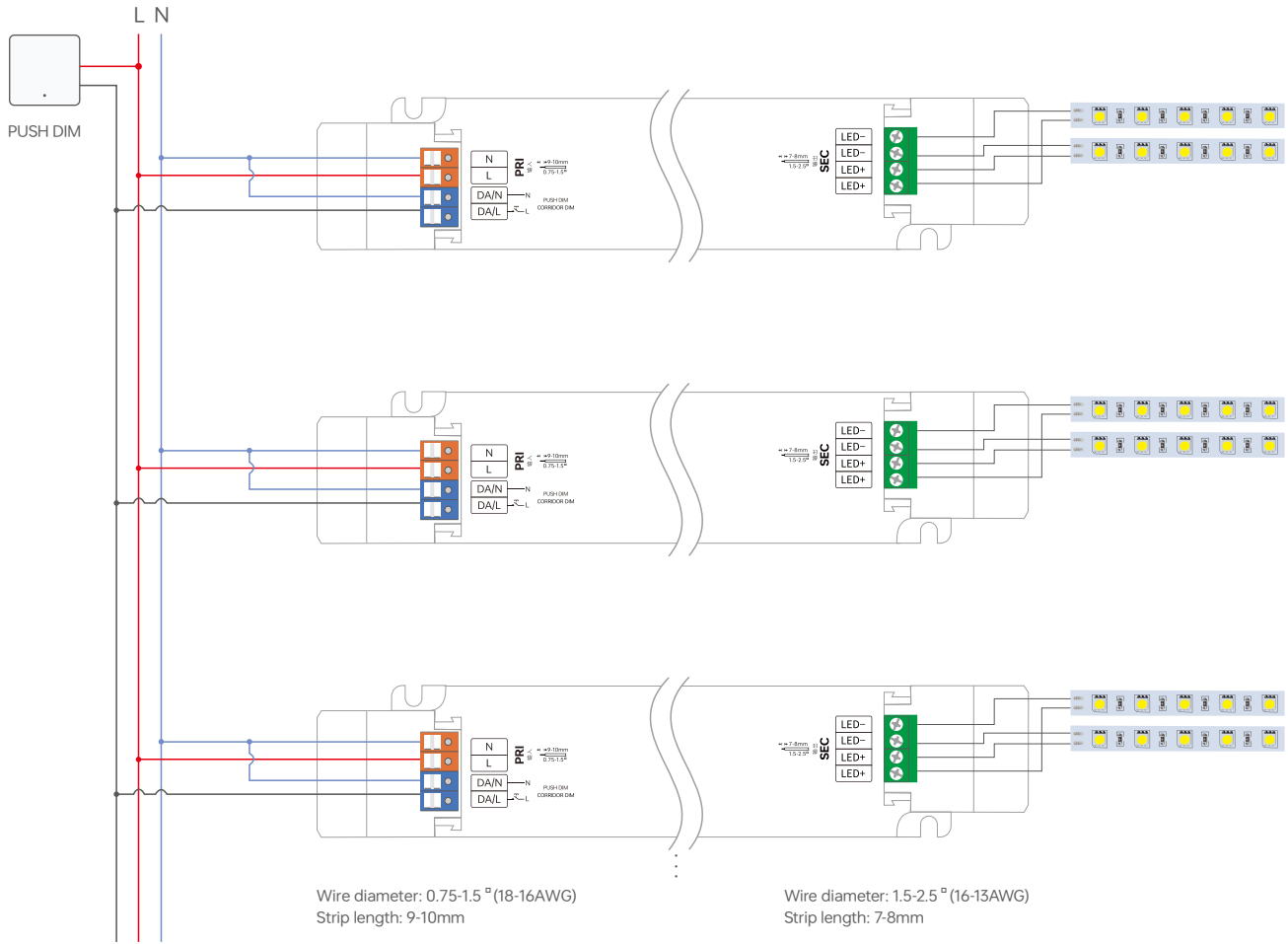

- \* Dimmer buttons are disabled under DC voltage input.
- \* Dimming interface priority: DALI takes precedence over PUSH DIM
- \* Power supplies of different models/wattages vary in hardware. Do not use them for dimming the same light film/light box to avoid inconsistent light activation and dimming. Recommend matching the same light film/light box with a power supply of the same model for consistent dimming.

**Switch to PUSH DIM Dimming Mode:**

**Method 1:** If the driver has been set to Corridor Dimming Mode, connect the wiring according to the PUSH DIM wiring diagram. Then, within 3 seconds, press the reset switch 5 times, press and hold for 6 seconds, and then press 5 times again within 3 seconds. The driver will automatically switch to PUSH DIM dimming mode.

**Method 2:** If the driver has been set to Corridor Mode, you can also switch to PUSH DIM dimming mode via the NFC Lighting App.

Note: If no DALI master is connected, the default factory setting is PUSH DIM mode.

**PUSH DIM**



Reset Switch

- Short press : on/off control.
- Double-click: Not available.
- Long press : Adjust the current brightness.
- Dimming memory : When the light is switched on/off again, the light will resumes to the previously set brightness level.

## Corridor Dimming Connection Method

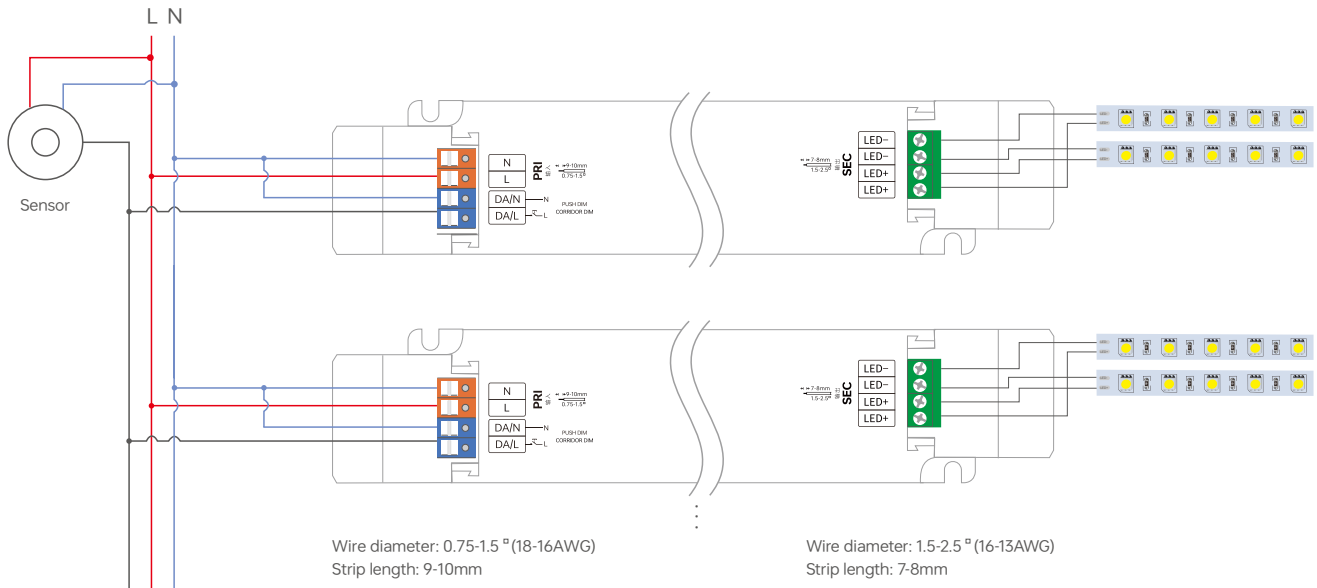

\* Dimmer buttons are disabled under DC voltage input.  
 \* Dimming interface priority: DALI takes precedence over Corridor light  
 \* Power supplies of different models/wattages vary in hardware. Do not use them for dimming the same light film/light box to avoid inconsistent light activation and dimming. Recommend matching the same light film/light box with a power supply of the same model for consistent dimming.

### Switch to the corridor light mode

- Method 1:** Configure and switch the corridor light function via NFC, and the Push DIM function will be turned off.
- Method 2:** After connecting the wires according to the corridor dimming wiring diagram, keep moving within the effective sensing area for more than 2 minutes, and it will automatically switch to the corridor dimming mode with all lights on at full brightness.
- Method 3:** After connecting the wires according to the corridor dimming wiring diagram, first replace the sensor with a common switch, then turn on the common switch and keep it conducting for 2 minutes. The driver will automatically switch to the corridor dimming mode. After that, remove the common switch and replace it with the sensor again.
- Note:** During normal operation, it is recommended to set the hold-time of the motion sensor to the minimum. It is necessary to select a motion sensor with an AC switch.

## Corridor Dimming: Working Process

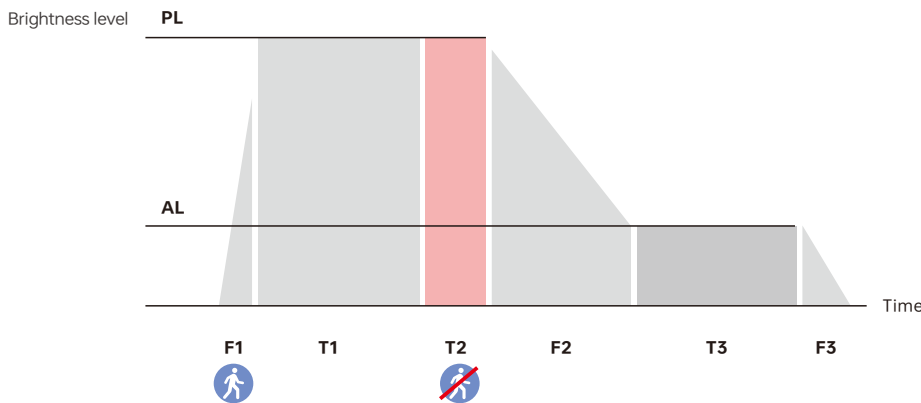

Name	Default	Setting Range
(F1) Gradual Entry Sensing Time	1 s	0-100 s
(PL) Sensing Brightness	255	0-255
(T1) Sensing Holding Time	Set through the sensor	
(T2) Delay Time	30 s	0 s, 5 s, 10 s, 20 s, 30 s, 45 s, 1 min, 2 min, 3 min, 5 min, 10 min, 20 min, 30 min
(F2) Gradual Exit Sensing Time	1 s	0-100 s
(AL) Standby Brightness	100	0-255
(T3) Sensing Standby Time	30 s	0 s, 5 s, 10 s, 20 s, 30 s, 45 s, 1 min, 2 mins, 3 mins, 5 mins, 10 mins, 20 mins, 30 mins, Permanent
(F3) Gradual Exit to Off Time	1 s	0-100 s

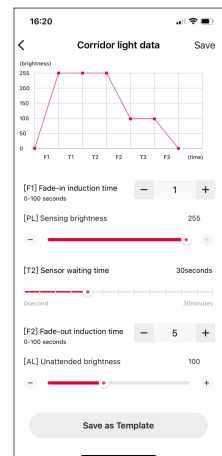

**Note:** \*If the lamp needs to be on standby at a low brightness level, the [T3] Sensing Standby Time should be set to "Permanent".  
 \*The above parameters are set through the NFC lighting APP.

## Protective Housing Application Diagram

### Tension plate

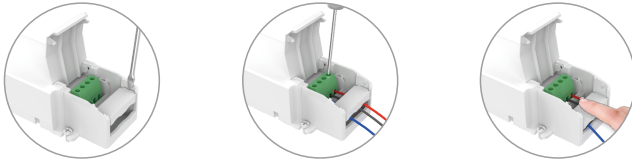

1. Pry up the protecting housing in the side plate position with a tool.
2. Connect to electrical wires with a screwdriver as wiring diagram shows.
3. Press down the tension plate to fix the the electrical wires, then close the protective housing.

### Remove the protective housing

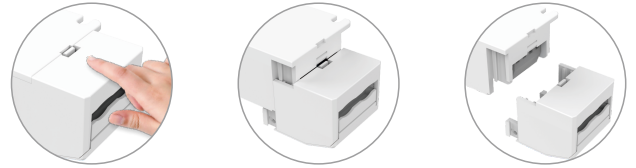

Pull the housing left and right from the bottom to remove it.

## Installation Precautions

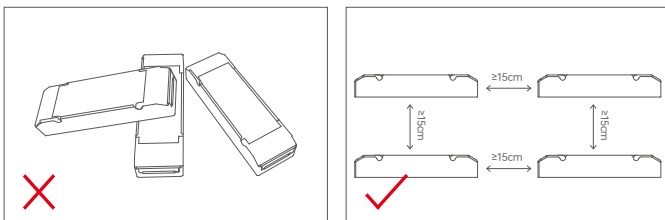

Please do not stack the products. The distance between two products should be  $\geq 15\text{cm}$  so as not to affect heat dissipation and the lifespan of the products.

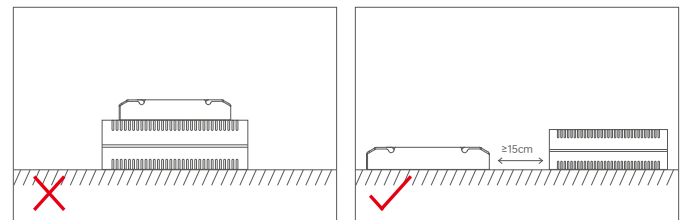

Please not place the products on LED drivers. The distance between the product and the driver should be  $\geq 15\text{cm}$  so as not to affect heat dissipation and shorten the lifespan of the products.

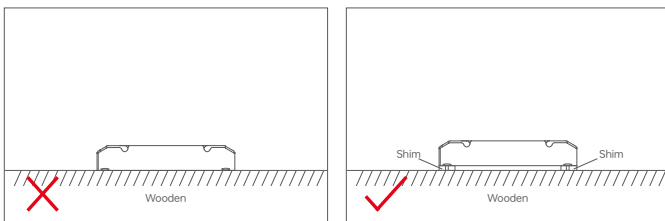

Please do not fasten the product screws tightly against the wooden board. Instead, add a washer of  $\geq 7\text{mm}$  under the fixing screws. Leaving a gap can effectively dissipate heat, preventing any impact on the product's heat dissipation and service life.

## Use the NFC Lighting APP

Scan the QR code below with your mobile phone and follow the prompts to complete the APP installation (According to performance requirements, you need to use a NFC-capable Android phone, or an iPhone 8 and later that are compatible with iOS 13 or higher).



\* Before you begin setting the parameters of the driver, please make sure the driver is powered off.

## Read/Write the LED driver

Use your NFC-capable phone to read LED driver data, then edit the parameters and they can be directly written to the driver.

### 1. Read the LED driver

On the APP home page, click [Read/Write LED driver] , then keep the programmer's sensing area close to the NFC sensing area of the driver to read the driver parameters.

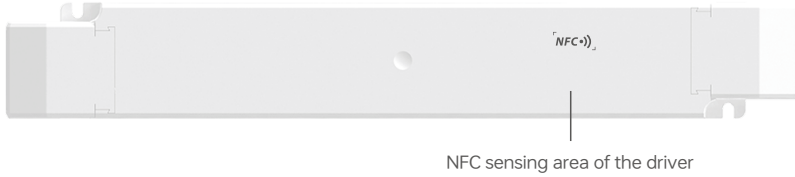

### 2. Edit parameters

Click on [Parameter Management] to edit more advanced parameters such as Select Brand, Dimming Type, Power-on Fading Time, Dimming Curve, PWM Frequency, and Brightness Range.

### 3. Write to the drive

After completing the parameter settings, click [Write] in the upper right corner, and keep the programmer's sensing area close to the NFC sensing area of the driver, so the parameters can be written to the driver

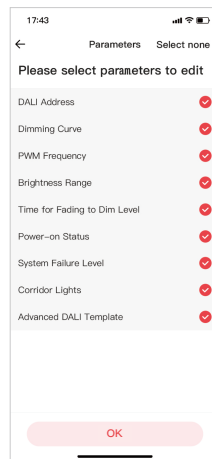
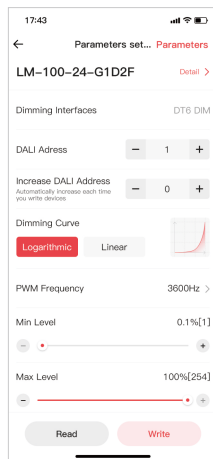
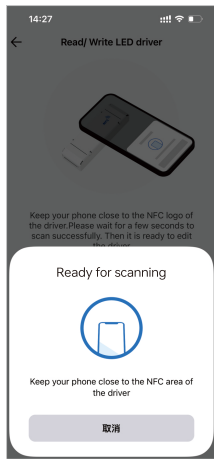

## Advanced DALI template

Integrate the functions of the DALI lighting system, edit the DALI group and lighting effects for scenes, then save them in the advanced template to achieve lighting programming.

Setup page (for Read/Write LED driver) : Go to App home page — click icon in the top right — [DALI template on phone] .

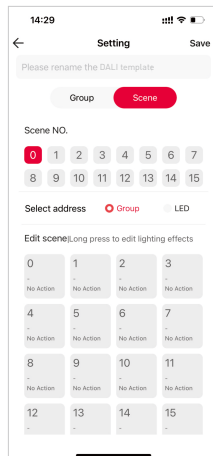
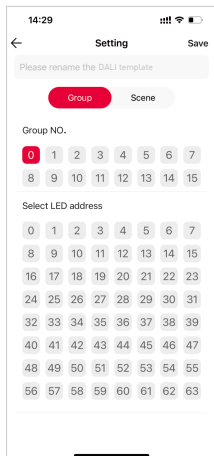
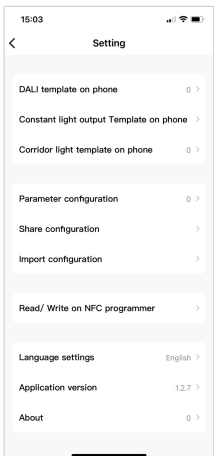

## Relationship Diagrams

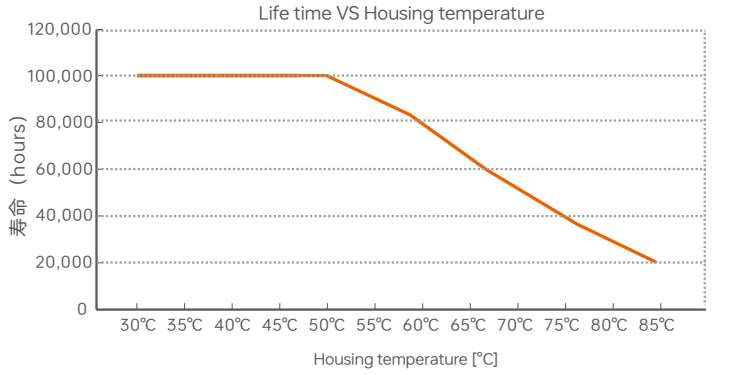
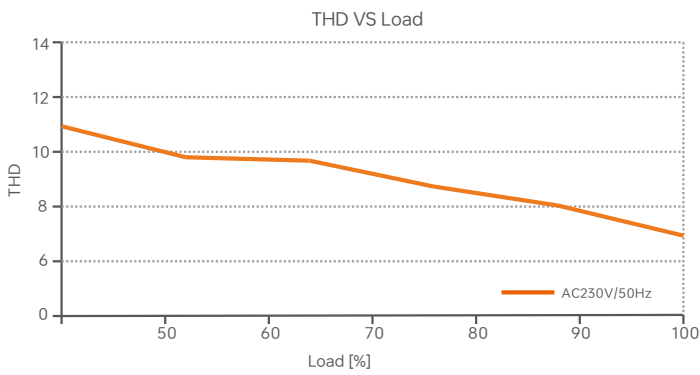
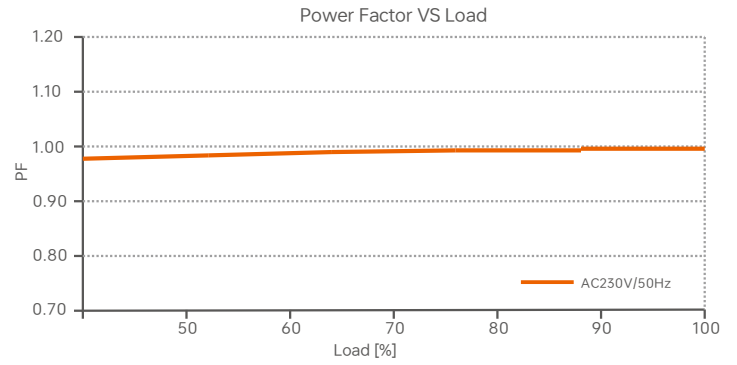
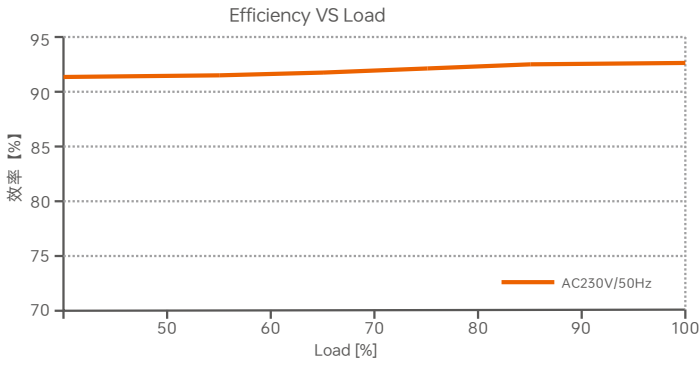

## Surge Current & Corresponding Miniature Circuit Breaker (MCB) Load Capacity Table

MCB Model	B10	B13	B16	B20	B25	C10	C13	C16	C20	C25	D10	D13	D16	D20	D25
Maximum Load Capacity	5	7	8	10	13	8	9	10	12	15	11	12	13	16	19

Remarks:

1. Test Conditions: Cold start 45A(Test twidth=300us tested under 50% Ipeak)/230V ~ .
2. The number of supported drivers may vary depending on the brand and model of the MCB.
3. It is recommended not to exceed the specified load capacity during on-site installation. The actual load should be determined based on field conditions.
4. If the ambient temperature exceeds 30°C or multiple MCBs are installed side by side, the number of installed drivers must be reduced and recalculated accordingly.
5. Electricians typically use Type B MCBs for residential lighting and Type C MCBs for commercial lighting applications.
6. Different testing equipment may yield variations in measured current peaks and pulse widths. Always use professional-grade instruments for accurate testing.

## Flicker Test Table

IEEE 1789

Limit Value of Modulation in Low Risk Areas	
Waveform frequency of Optical output (f)	Limit value (%)
$f \leq 8\text{Hz}$	0.2
$8\text{Hz} < f \leq 90\text{Hz}$	$0.025 \times f$
$90\text{Hz} < f \leq 1250\text{Hz}$	$0.08 \times f$
$f > 1250\text{Hz}$	Exemption assessment
Limit Value of Modulation in No Effect Areas	
Waveform frequency of Optical output (f)	Limit value (%)
$f \leq 10\text{Hz}$	0.1
$10\text{Hz} < f \leq 90\text{Hz}$	$0.01 \times f$
$90\text{Hz} < f \leq 3125\text{Hz}$	$(0.08/2.5) \times f$
$f > 3125\text{Hz}$	Exemption assessment (High frequency exemption)

Brightness

- ▲ 0.1%
- ◆ 1%
- ▲ 5%
- ▲ 10%
- 20%
- ▲ 30%
- 40%
- ★ 50%
- 60%
- 70%
- ★ 80%
- ★ 90%
- ◆ 100%

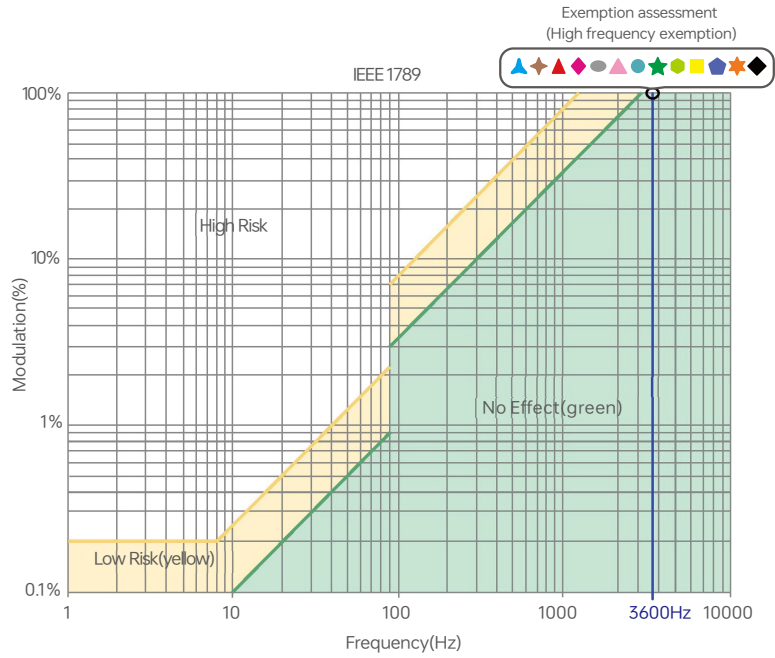

## Packaging Specification

Model	LM-100-24-G1D2F
Packaging box size	315×215×240mm(L×W×H)
Quantity	10PCS per layer, 2 layers per box, 20PCS per box
Weight	0.3kg per PC, 10kg±5% per box

## Packaging Style Drawing

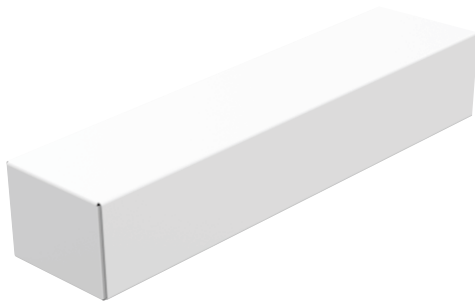

Inner packaging box



Full box packaging

## Transportation and Storage

### 1. Transportation

Products can be shipped via vehicles, boats and planes.

During transportation, products should be protected from rain and sun. Please avoid severe shock and vibration during the loading and unloading process.

### 2. Storage

The storage conditions should comply with the Class I Environmental Standards. The products that have been stored for more than six months are recommended to be re-inspected and can be used only after they have been qualified.

## Attentions

- Product installation and commissioning should be done by a qualified professional.
- LTECH products are and not lightningproof non-waterproof (special models excepted). Please avoid the sun and rain. When installed outdoors, please ensure they are mounted in a water proof enclosure or in an area equipped with lightning protection devices.
- Good heat dissipation will prolong the working life of products. Please ensure good ventilation.
- Please check if the working voltage used complies with the parameter requirements of products.
- The diameter of wire used must be able to load the light fixtures you connect and ensure the firm wiring.
- Before you power on products, please make sure all the wiring is correct in case of incorrect connection that causes damage to light fixtures.
- If a fault occurs, please do not attempt to fix products by yourself. If you have any question, please contact your suppliers.
- \* This manual is subject to changes without further notice. Product functions depend on the goods. Please feel free to contact our official distributors if you have any question.

## Warranty Agreement

- Warranty periods from the date of delivery: 5 years.
- Free repair or replacement services for quality problems are provided within warranty periods.

Warranty exclusions below:

- Beyond warranty periods.
- Any artificial damage caused by high voltage, overload, or improper operations.
- Products with severe physical damage.
- Damage caused by natural disasters and force majeure.
- Warranty labels and barcodes have been damaged.
- No any contract signed by LTECH.

1. Repair or replacement provided is the only remedy for customers. LTECH is not liable for any incidental or consequential damage unless it is within the law.
2. LTECH has the right to amend or adjust the terms of this warranty, and release in written form shall prevail.

## Update Log

Version	Updated Time	Update Conten	Updated by
A0	20250730	Original version	Haipeng Li