

Key Features & Benefits:

- Multiple Mounting Options Designed to Retrofit: – Street Lights – High Bays and Low Bays – Garage Lights – Shoebox Fixtures – Wall Packs
- Utilize Existing Feature
- Up to a 75% Energy Savings
- 10 Year Warranty
- Optimized Pin Array Heat Sink
- Overheat Shutdown
- Intelligent Thermal Control
- Compatible with Networked Lighting Control Qualified Systems

Project: _____

Date: _____

Catalog #: _____

Notes: _____

Product Specifications:

Wattage: 45W
 Kelvin: 4000K
 Max Lumen Output: 5,515 Lumens
 Max Efficacy: 117 lm/W
 Voltage: 277–480 VAC
 Input Frequency: 50/60 Hz
 Surge Protection: Yes
 Operating Temperature: -40°F to 176°F (-40°C to 80°C)
 Dimming: 0–10V 12V AUX
 Dimming Range: 0-100%
 Dim to Off: true
 CRI: >75
 Dimensions: L4.61" x W4.61" x H2.72"
 Weight (lbs): 0.77
 Finish: WH (White)
 L70 Lifetime Calculated per TM21: 100,000 hours
 Warranty: 10 Year



Ordering Guide:

ESL	TYPE	WATTS	GEN	KELVIN	VOLTAGE
ESL	MUR	45W	3	40K	HV
	(MUR) MultiUse Retrofit	(45W) 45 Watts (75W) 75 Watts (105W) 105 Watts (120W) 120 Watts (150W) 150 Watts (200W) 200 Watts	(3) 3rd Gen	(30) 3000K (40) 4000K (50) 5000K	(Blank) 120 V (HV) 277–480 V

Integrated-style kits that replace all reflectors and optical systems of existing luminaires. Not screw-in “lamps” intended as HID replacements.



Retrofit Kits for Outdoor Pole/Arm-Mounted Area and Roadway Luminaires

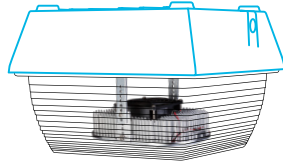

Retrofit Kits for Fuel Pump Canopy Luminaires

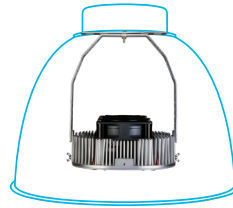

Retrofit Kits for High-Bay Luminaires for Commercial and Industrial Buildings

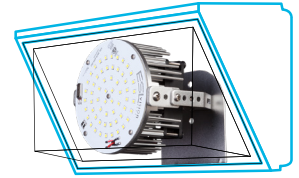

Retrofit Kits for Outdoor Full-Cutoff Wall-Mounted Luminaires

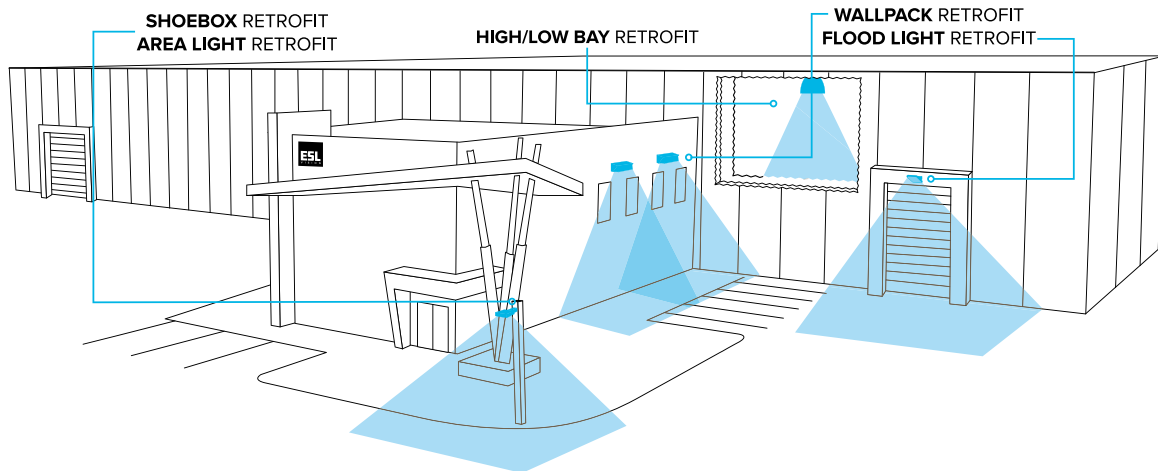

FIELD INSTALLED ACCESSORIES

ESL-3OCC	IP65 0–10v Dimming Sensor. 8'–50' Mounting, Wire From Side
ESL-3OCCB	IP65 0–10v Dimming Sensor. 8'–50' Mounting, Wire From Top
ESL-4OCC-LDD	Photocell/Occupancy Sensor for Standard Mounting, Dip Switch, 0–10v
ESL-SPD-277-1	Hard Wire Surge Protector; (100–277 VAC) Max Discharge Current: 20kA
ESL-REM-100	Hand Held Remote to Program 2OCC-HDD, 3OCC/B and 4OCC-LDD

Catalog Data:

ITEM#	WATTS	KELVIN	MAX LUMEN OUTPUT	EFFICACY (lm/W)	INPUT VOLTAGE	DLC QPL CODE
ESL-MUR-45W-330	45W	(30) 3000K	5542	120	120-277 VAC	PDUIMN20
ESL-MUR-45W-340		(40) 4000K	5,660	122	120-277 VAC	PH9CHOHS
ESL-MUR-45W-350		(50) 5000K	5,778	125	120-277 VAC	PJFZK5QR
ESL-MUR-45W-330-HV	45W	(30) 3000K	5,416	120	277-480 VAC	P2ELDO0V
ESL-MUR-45W-340-HV		(40) 4000K	5,515	122	277-480 VAC	PA4091W9
ESL-MUR-45W-350-HV		(50) 5000K	5,615	125	277-480 VAC	PVW6L1BW
ESL-MUR-75W-330	75W	(30) 3000K	9,573	131	120-277 VAC	PA1OBGQ7
ESL-MUR-75W-340		(40) 4000K	9,774	134	120-277 VAC	PZYSYRH5
ESL-MUR-75W-350		(50) 5000K	9,974	136	120-277 VAC	PU1PKK8A
ESL-MUR-75W-330-HV	75W	(30) 3000K	9,613	131	277-480 VAC	P6ZLUL79
ESL-MUR-75W-340-HV		(40) 4000K	9,781	134	277-480 VAC	PVFXNJCG
ESL-MUR-75W-350-HV		(50) 5000K	9,949	136	277-480 VAC	PZ6E0MEQ
ESL-MUR-105W-330	105W	(30) 3000K	13,298	128	120-277 VAC	PA029GCY
ESL-MUR-105W-340		(40) 4000K	13,576	130	120-277 VAC	PQ2HQL77
ESL-MUR-105W-350		(50) 5000K	13,853	132	120-277 VAC	PT4HK5VN
ESL-MUR-105W-330-HV	105W	(30) 3000K	12,975	124	277-480 VAC	PW9VB0M0
ESL-MUR-105W-340-HV		(40) 4000K	13,182	126	277-480 VAC	PQZTGD62
ESL-MUR-105W-350-HV		(50) 5000K	13,400	128	277-480 VAC	P9D6B5C6
ESL-MUR-120W-330	120W	(30) 3000K	13,298	128	120-277 VAC	PA029GCY
ESL-MUR-120W-340		(40) 4000K	13,576	130	120-277 VAC	PQ2HQL77
ESL-MUR-120W-350		(50) 5000K	13,853	132	120-277 VAC	PT4HK5VN
ESL-MUR-120W-330-HV	120W	(30) 3000K	12,975	124	277-480 VAC	PW9VB0M0
ESL-MUR-120W-340-HV		(40) 4000K	13,182	126	277-480 VAC	PQZTGD62
ESL-MUR-120W-350-HV		(50) 5000K	13,400	128	277-480 VAC	P9D6B5C6
ESL-MUR-150W-330	150W	(30) 3000K	19,350	130	120-277 VAC	PH7YZY3D
ESL-MUR-150W-340		(40) 4000K	19,759	132	120-277 VAC	P8O6VD47
ESL-MUR-150W-350		(50) 5000K	20,168	134	120-277 VAC	PLAINCDA
ESL-MUR-150W-330-HV	150W	(30) 3000K	19,101	128	277-480 VAC	PWX6662L
ESL-MUR-150W-340-HV		(40) 4000K	19,400	130	277-480 VAC	P8YC9ZIU
ESL-MUR-150W-350-HV		(50) 5000K	19,709	132	277-480 VAC	PGSCGZ8L
ESL-MUR-200W-330	200W	(30) 3000K	25,087	122	120-277 VAC	P37E8RXB
ESL-MUR-200W-340		(40) 4000K	25,462	124	120-277 VAC	P87K6XAJ
ESL-MUR-200W-350		(50) 5000K	25,837	127	120-277 VAC	POMNBEFU
ESL-MUR-200W-330-HV	200W	(30) 3000K	25,029	121	277-480 VAC	PWOB3NAD
ESL-MUR-200W-340-HV		(40) 4000K	25,453	123	277-480 VAC	PBQDC85D
ESL-MUR-200W-350-HV		(50) 5000K	25,890	125	277-480 VAC	PKJ7S2H6
ESL-MUR-280W-330	280W	(30) 3000K	38,820	138	120-277 VAC	S-MC50QS
ESL-MUR-280W-340		(40) 4000K	39,343	140	120-277 VAC	S-LTXCOK
ESL-MUR-280W-350		(50) 5000K	39,866	141	120-277 VAC	S-2ZNP4R
ESL-MUR-280W-330-HV	280W	(30) 3000K	40,433	141	277-480 VAC	S-BQS8EM
ESL-MUR-280W-340-HV		(40) 4000K	40,956	143	277-480 VAC	S-XDR4HL
ESL-MUR-280W-350-HV		(50) 5000K	41,479	145	277-480 VAC	S-P1TBAD
ESL-MUR-350W-330	350W	(30) 3000K	46,649	133	120-277 VAC	S-M6GWTR
ESL-MUR-350W-340		(40) 4000K	47,295	135	120-277 VAC	S-523TH0
ESL-MUR-350W-350		(50) 5000K	47,941	137	120-277 VAC	S-WRXCPO
ESL-MUR-350W-330-HV	350W	(30) 3000K	47,558	138	277-480 VAC	S-098KXG
ESL-MUR-350W-340-HV		(40) 4000K	48,173	140	277-480 VAC	S-BXJL42
ESL-MUR-350W-350-HV		(50) 5000K	48,787	142	277-480 VAC	S-VMP2BU

Dimensions:

ESL-MUR-45W

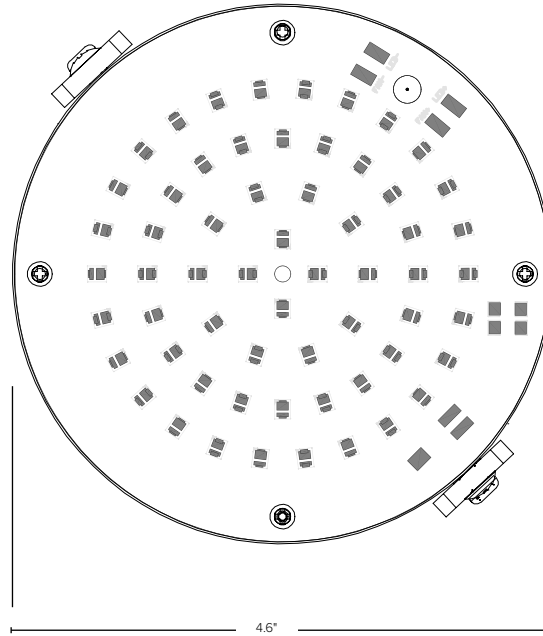
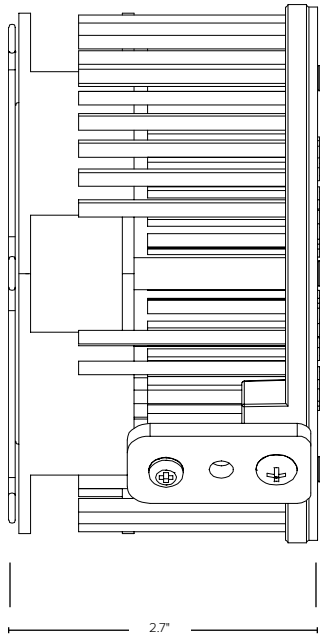

ESL-MUR-, 75W, 105W, 120W

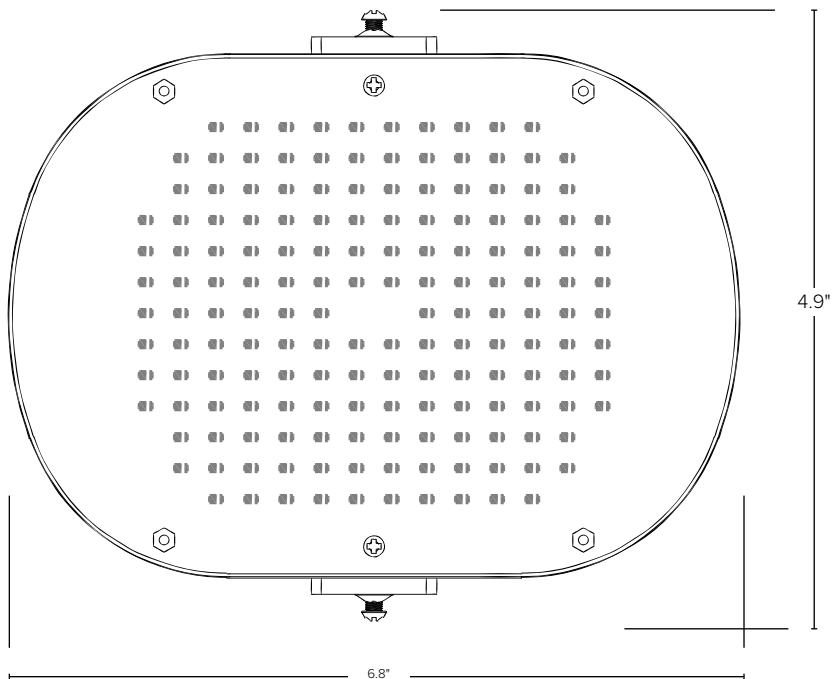
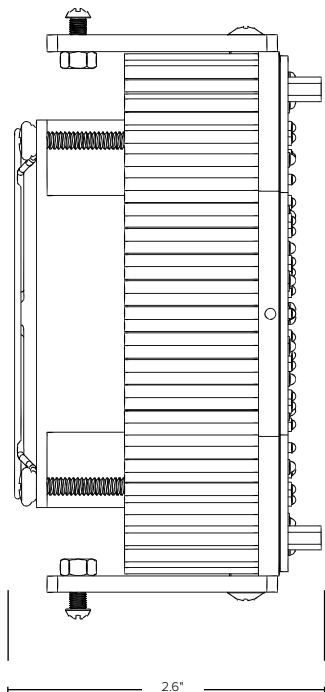

Dimensions:

ESL-MUR-150W, 200W

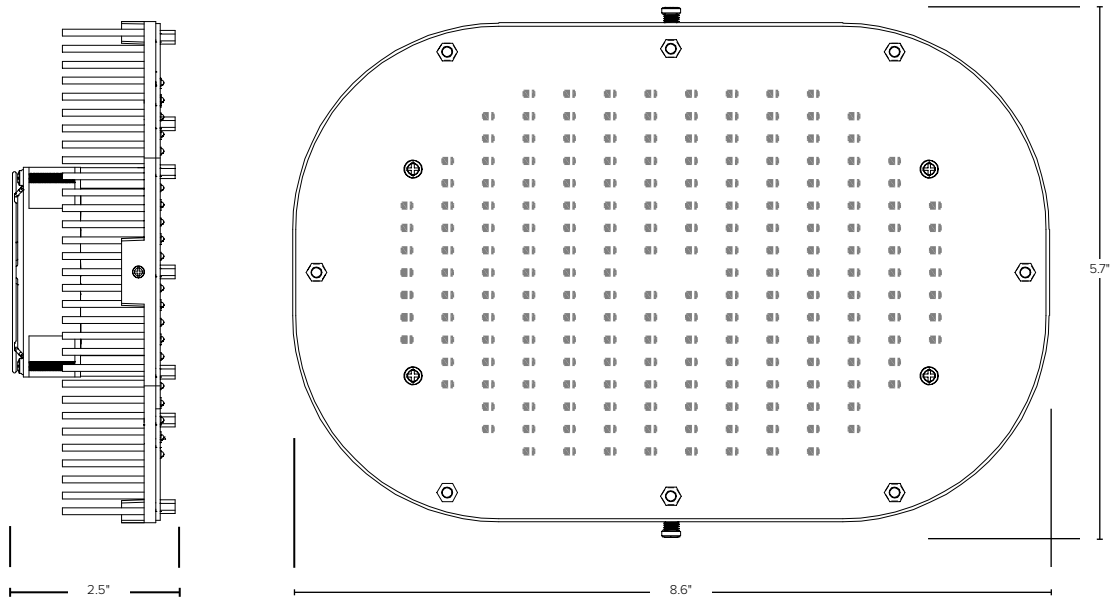

ESL-MUR-280W, 350W

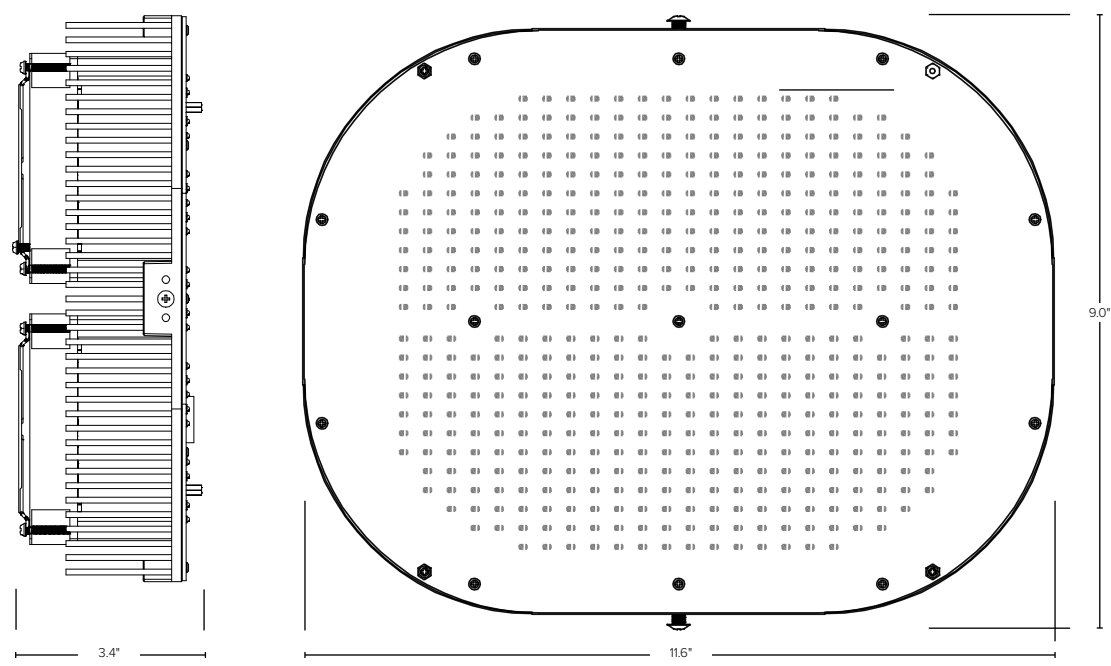

Standard Driver Dimensions:

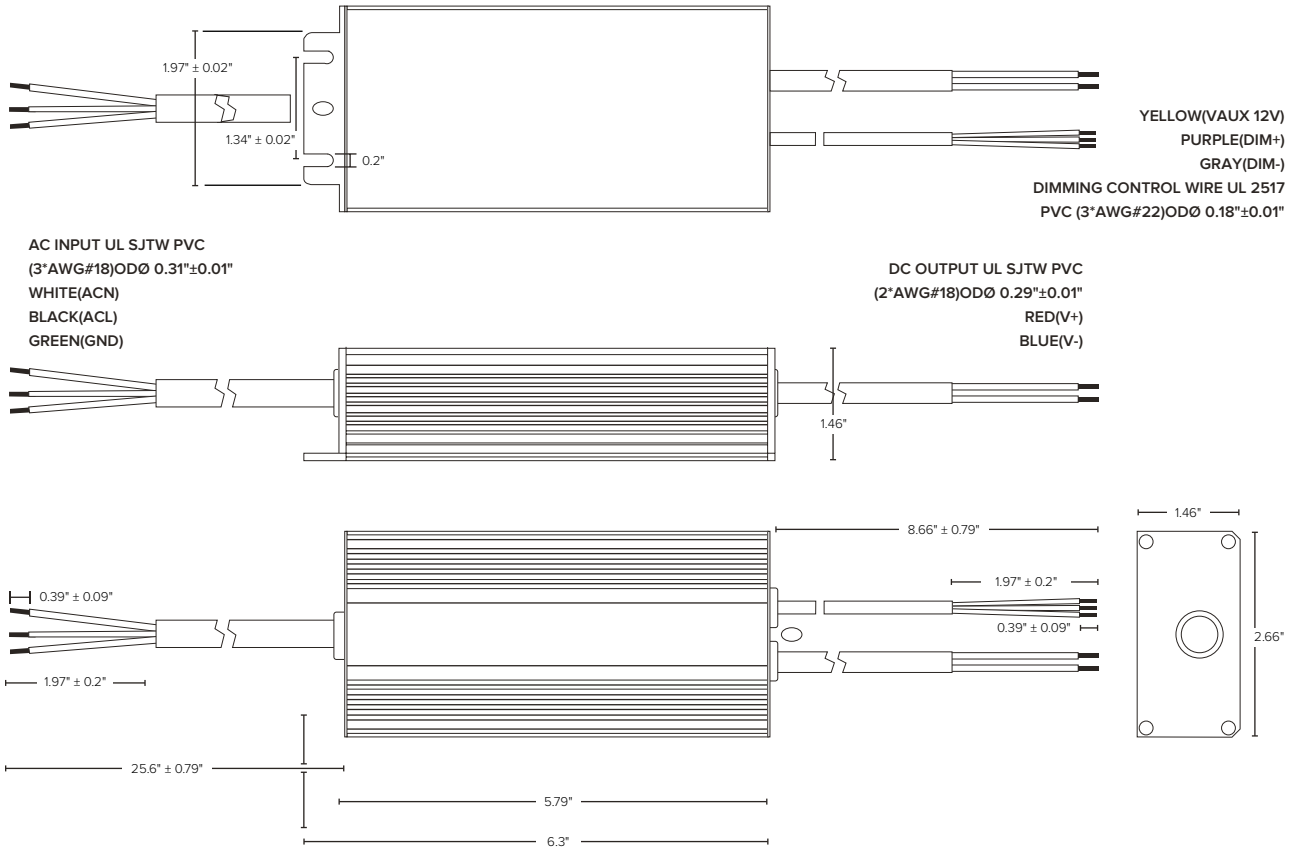

High Voltage Driver Dimensions:

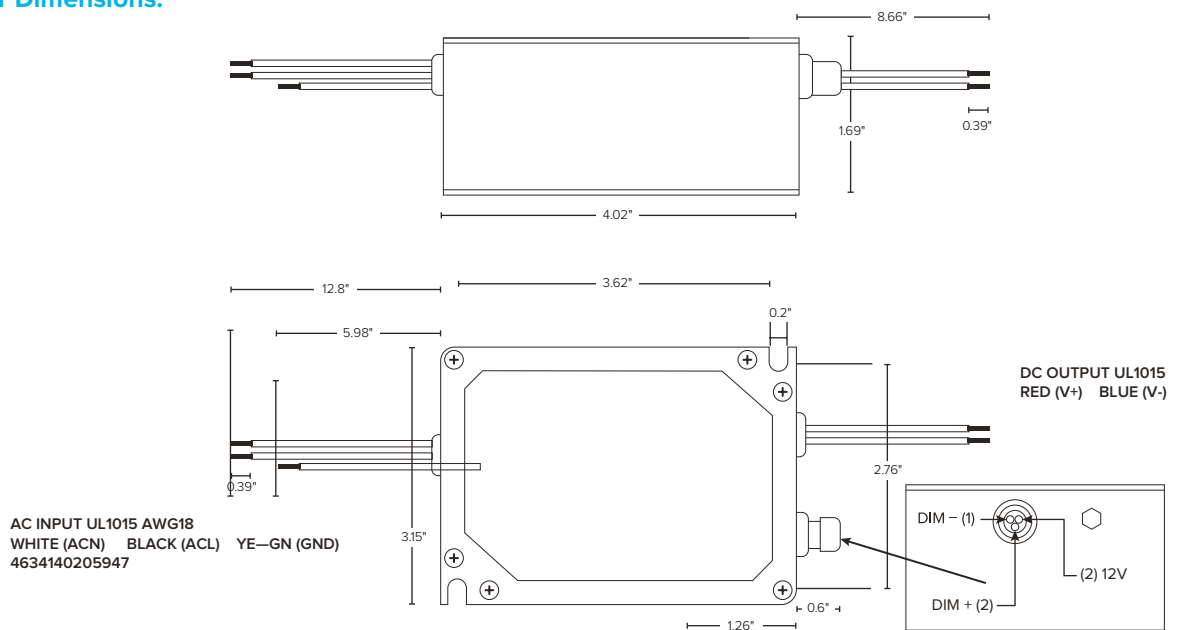

What's Included:

- (1) LED MUR
- (1) LED Outdoor Driver
- Assembled Mounting Hardware
 - U-Bracket
 - L-Bracket
- Additional Mounting Hardware
 - Hanger Block
 - L-Plate
 - Small Plate
 - Large Plate

U-Bracket

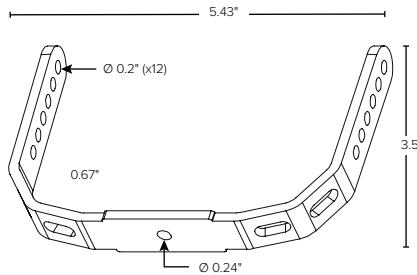

L-Bracket

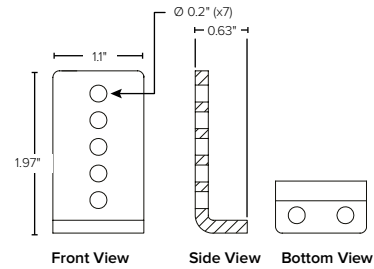

Hanger Block

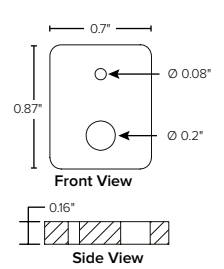

L-Plate

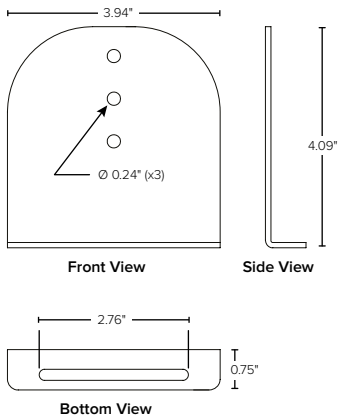

Small Plate

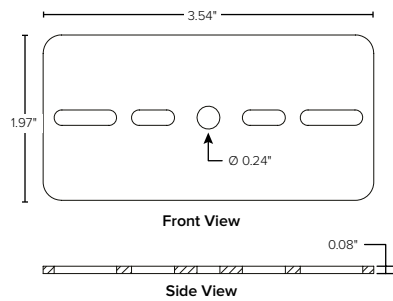

Large Plate

