



# LED EMERGENCY DRIVER

## ESL-EMG-SL6-CSC-40W

### Key Features & Benefits:

- Field or Factory Installation—UL 924 and CSA C22.2 No. 141 Emergency Lighting Compliant
- Meets CEC Title 20 Requirements.
- Monthly and Yearly Auto Test Function for Reduced Maintenance.
- Meets or Exceeds All NEC Emergency Lighting Standards.
- Slim Profile Design
- Compatible With AC Input Lamps And DC Output Drivers (see wiring diagrams for more info)
- Constant Power Output Provides 90 Minutes of Consistent Egress Lighting with No Degradation
- Emergency Test Button Wall Plate
- An Illuminated Test Switch/Charging Indicator Light is Provided

Project: \_\_\_\_\_ Date: \_\_\_\_\_

Catalog #: \_\_\_\_\_

Notes: \_\_\_\_\_

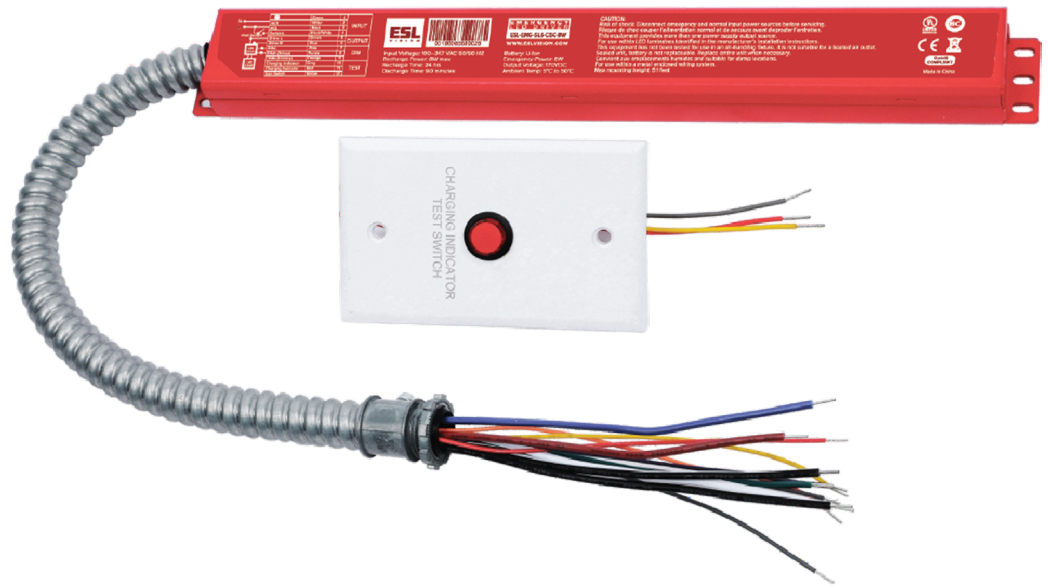

### Product Specifications:

#### Input

Rated Current: 150 mA (Max)  
 AC Input Power Rating: 10W  
 Rated Voltage: 100–347 VAC 50/60Hz

#### Output

Emergency Output Power: 40W (Max)  
 Output Voltage: 170 VDC  
 Output Short Protection: Yes  
 Output Open Protection: Yes

#### Emergency

Emergency Operation: 90 Minutes  
 Charging Time: 24 Hours  
 Charging Cycles: 1000

#### Environment

Operating Temperature: 41° to 122°F(5° to 50°C)  
 Dimensions (LxWxH): 13.59" x 1.54" x 0.99"  
 Weight (lbs): 2.66

### Emergency Lumen Output:

FIXTURE EFFICACY	OUTPUT POWER (8W)	OUTPUT POWER (18W)	OUTPUT POWER (40W)
100 lm/W	800 Lumens	1,800 Lumens	4,000 Lumens
120 lm/W	960 Lumens	2,160 Lumens	4,800 Lumens
140 lm/W	1,120 Lumens	2,520 Lumens	5,600 Lumens



### Wiring Diagrams:

Standard Installation to 0-10V Dimmable Fixture

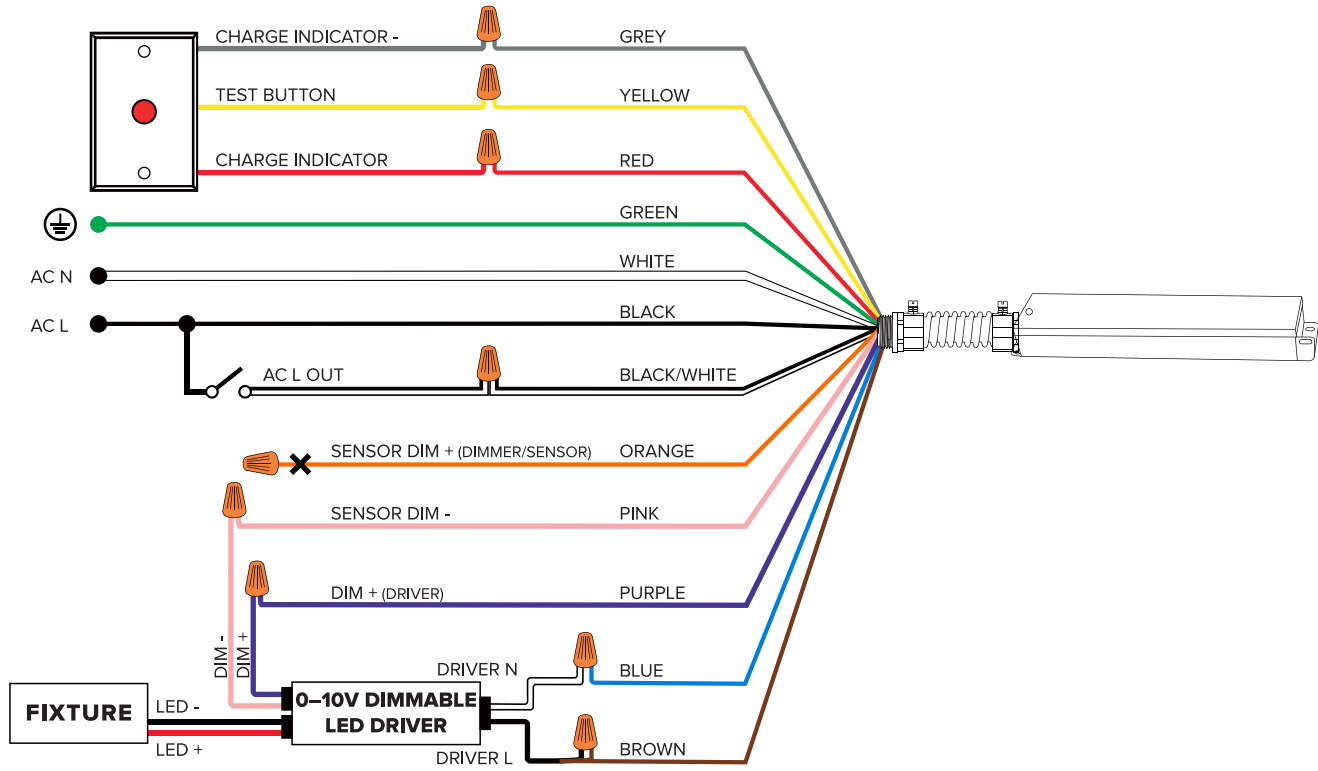

### Wiring Diagrams:

Non-Dimming Fixture Installation

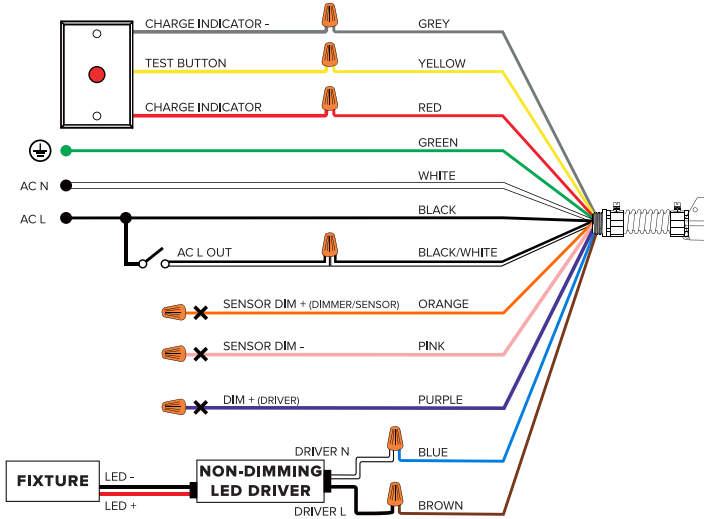

AC Sensor Installation

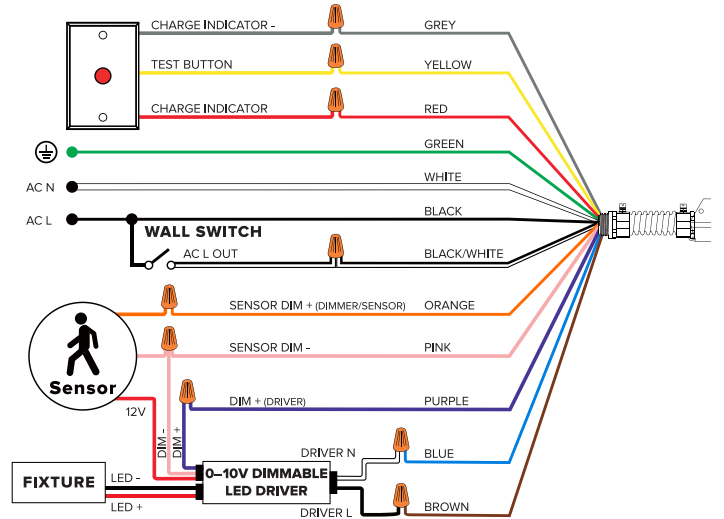

Dimmer Installation

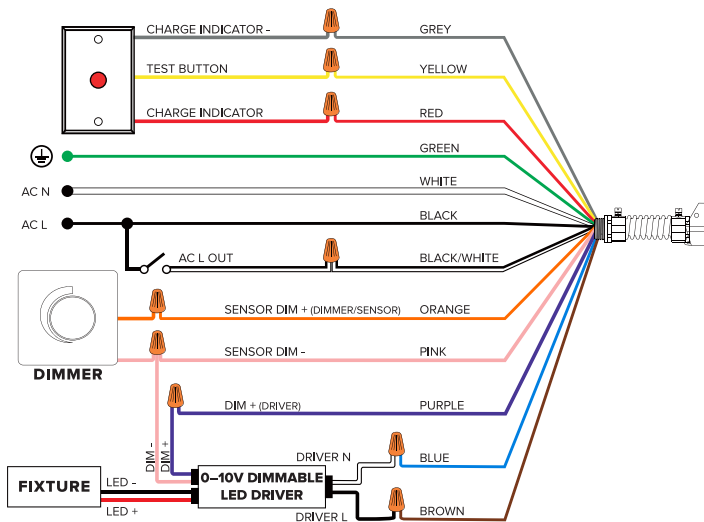

DC Sensor Installation

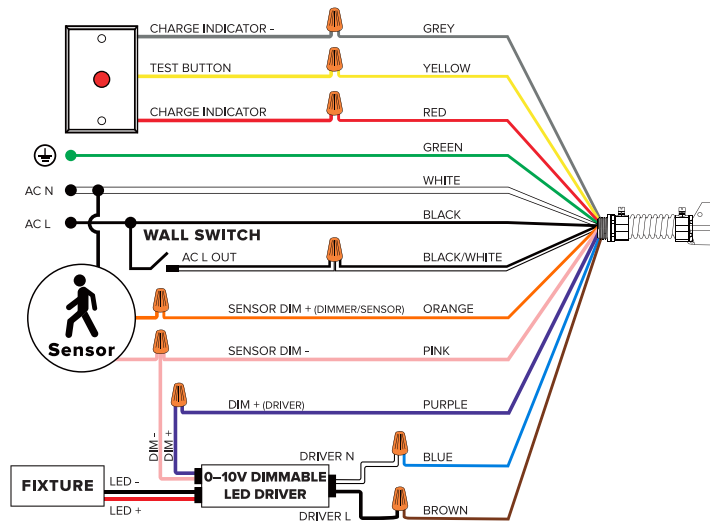

**Dimensions:**

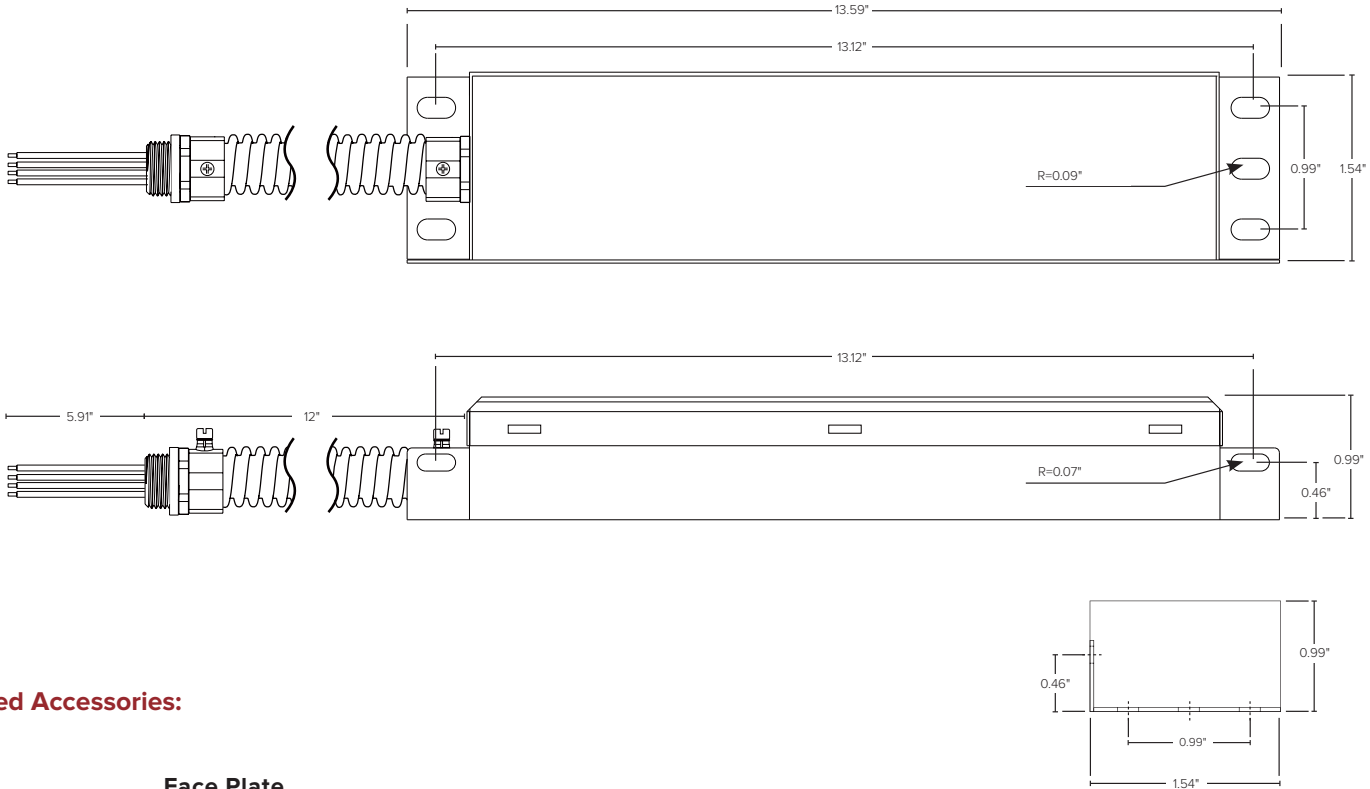

**Included Accessories:**

**Face Plate**

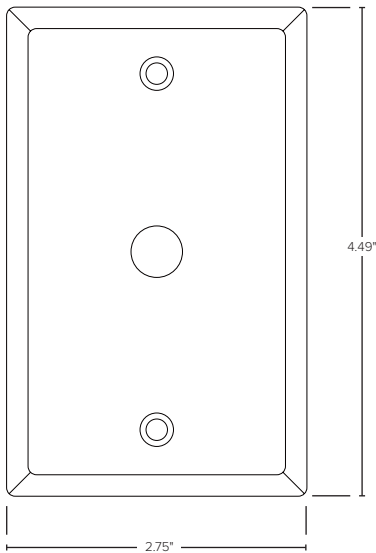

**Plastic Integrated Indicator Light**

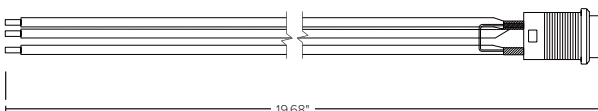

Installation Hole Size: Ø0.63"

**OPERATION (INDICATOR STATUS)**

MODE	TEST BUTTON OPERATION	INDICATOR STATUS	SOLUTION
AC Mode (1)	NO Press	ON (no flashing)	Emergency LED driver is charging.
AC Mode (2)	Press Once	2s ON and 2s OFF (Slow flashing)	Emergency LED driver is conducting a 30s short-term emergency test. After 30 seconds, it will automatically restore to normal charging mode.
AC Mode (3)	Press Twice (2s) in Sequence	2s ON and 2s OFF (Slow flashing)	Emergency LED driver is conducting a long-term emergency test until battery is fully discharged.
Emergency Mode	NO Press	2s ON and 2s OFF (Slow flashing)	Emergency LED driver is conducting a long-term emergency test until battery has no power.
Abnormal	When flashes (50ms ON and (50ms OFF fast, the emergency backup is abnormal. Contact Manufacturer.		

**WARNING**  
Risk of Electrical Shock



Note: Please press test button once to make certain the battery is turned off, before installation, maintenance, storage or shipping.