

### ⚠ WARNING

1. To avoid electric shock, disconnect power at source prior to installation.
2. The installation should be performed by qualified electricians or lighting technicians.
3. Do not touch the fixture while it is in service.
4. Do not use any electric generator to test the fixture.
5. Proper earth grounding is required for safety.
6. If there is any problem with the fixture, turn off power and DO NOT attempt repair unless you are a qualified technician.
7. Do not surface mount without the proper surface mount kit. Any fixture installed without proper distance from surface will no longer be under warranty.

### Field Adjustable

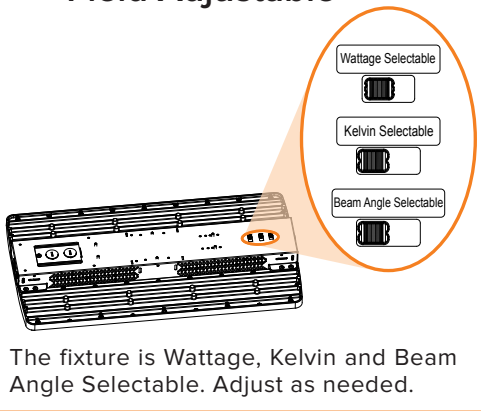

### Suspension Mount

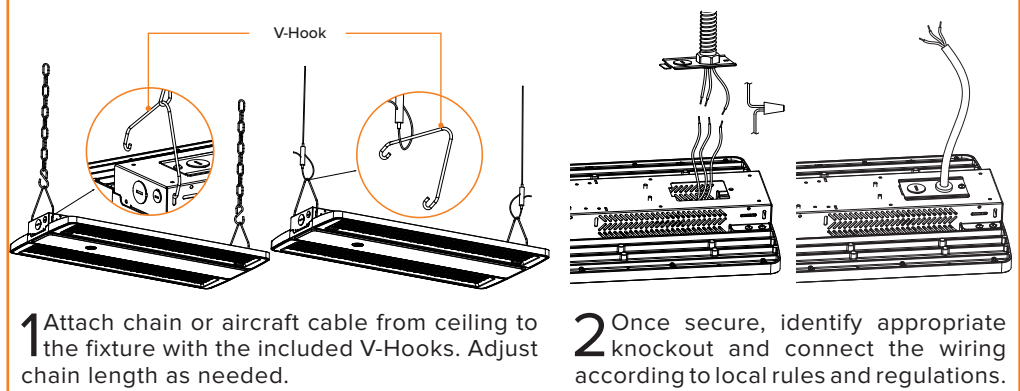

### Pendant Mount

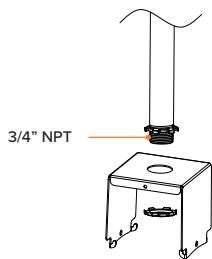

1 Mount the bracket to the 3/4" NPT (Conduit is not included, mounting bracket sold separately).

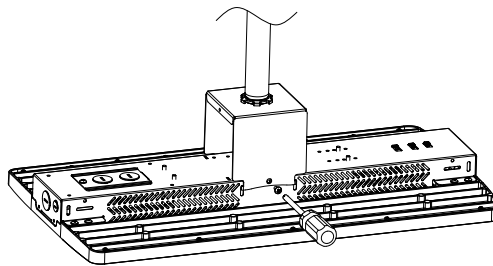

2 Lift the fixture to the bracket and secure the fixture. Connect the wires through the opening of the bracket.

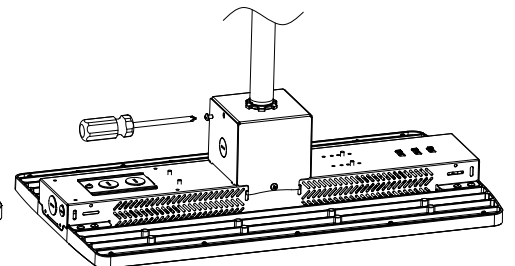

3 After wiring is secured within bracket mount, secure the side brackets onto the front and back of main bracket.

### Surface Mount

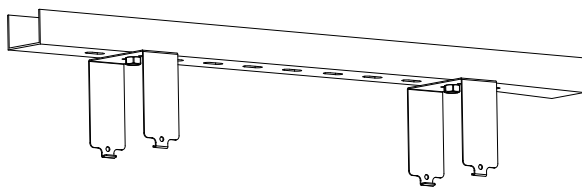

1 Mount the optional bracket (sold separately) on a suitable surface such as a stable beam or the ceiling.

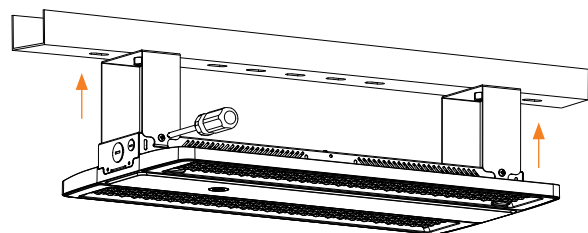

2 Assemble the fixture on the bracket and secure with screws.

### Wireguard

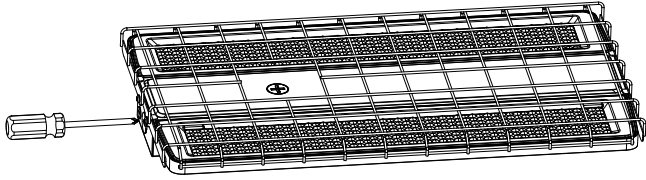

Place the optional wireguard (sold separately) onto the fixture and secure with screws.

### Sensors

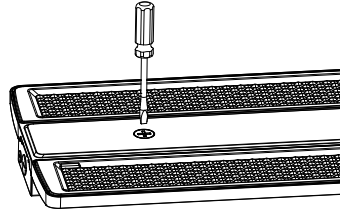

**1** Remove the 1/2" cap on fixture body with a screwdriver.

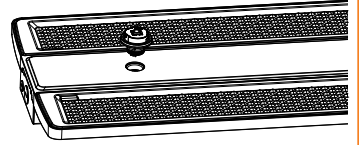

**2** Twist to secure optional sensor (sold separately) into fixture.

### Wiring Guide

