

Key Features & Benefits:

- Field or Factory Installation—UL 924 and CSA C22.2 No. 141 Emergency Lighting Compliant
- Meets CEC Title 20 Requirements.
- Monthly and Yearly Auto Test Function for Reduced Maintenance.
- Meets or Exceeds All NEC Emergency Lighting Standards.
- IP65 Wet Location Listed
- For Use with Round High Bay Fixture with Integrated 0–10V Drivers. (See Wiring Diagrams for More Info)
- Constant Power Output Provides 90 Minutes of Consistent Egress Lighting with No Degradation

Project: _____

Date: _____

Catalog #: _____

Notes: _____

Product Specifications:

Input

Rated Current: .2A (Max)
 AC Input Power Rating: 12W
 Rated Voltage: 100–347 VAC 50/60Hz

Output

Emergency Output Power: 25W (Max)
 Output Voltage: 170 VDC

Emergency

Emergency Operation: 90 Minutes
 Charging Time: 24 Hours
 Charging Cycles: 1,000

Environment

Operating Temperature: 32° to 122°F (0° to 50°C)
 Dimensions (LxWxH): 5.47" x 5.47" x 5.55"
 Mounting Length: 6.8"
 Weight (lbs): 3.96



Ordering Guide:

ESL	-	FAMILY	-	TYPE	-	FRAME	-	OUTPUT POWER
ESL	-	EMG (EMG) Emergency	-	HB2 (HB2) High Bay Gen 2	-	CWR (CWR) Closed Wet Rated	-	25W (25W) 25 Watts (40W) 40 Watts

Catalog Data:

ITEM#	DESCRIPTION
ESL-EMG-HB2-CWR-25W	Emergency backup battery unit, auto test function, 25-watt output, 90-minutes minimum, 100–347 VAC input, 170 VDC output, closed cylinder, UL listed for factory or field install, Title 20.
ESL-EMG-HB2-CWR-40W	Emergency backup battery unit, auto test function, 40-watt output, 90-minutes minimum, 100–347 VAC input, 170 VDC output, closed cylinder, UL listed for factory or field install, Title 20.
INCLUDED ACCESSORIES	DESCRIPTION
ESL-EMG-HB2-CONNECT-RODM10	Connecting rod M10 for EMG HB2
ESL-ACCS-LOOP-M10	Mounting loop for EMG HB2
ESL-ACCS-HOOK-M10	Mounting hook for EMG HB2
ESL-ASMB-GLAND-PG11	Nylon cable gland, black, PG11, 5–10mm OD wire

Emergency Lumen Output:

FIXTURE EFFICACY	OUTPUT POWER (15W)
100 lm/W	2,500 Lumens
120 lm/W	3,000 Lumens
140 lm/W	3,500 Lumens



Operation (Indicator Status)

MODE	TEST BUTTON OPERATION	INDICATOR STATUS	SOLUTION
AC Mode (1)	NO Press	ON (no flashing)	Emergency LED driver is charging.
AC Mode (2)	Press Once	2s ON and 2s OFF (slow flashing)	Emergency LED driver is conducting a 30s short-term emergency test. After 30 seconds, it will automatically return to normal charging mode.
AC Mode (3)	Press Twice (2s) in Sequence	2s ON and 2s OFF (slow flashing)	Emergency LED driver is conducting a long-term emergency test until battery is fully discharged.
Emergency Mode	NO Press	2s ON and 2s OFF (slow flashing)	Emergency LED driver is conducting a long-term emergency test until battery is drained of power.
Abnormal	When flashes ON (50ms) and OFF (50ms) fast, the emergency backup is abnormal. Contact the manufacturer.		

WARNING
Risk of Electrical Shock

Note: Please press test button once to make certain the battery is turned off before installation, maintenance, storage or shipping.

Dimensions:

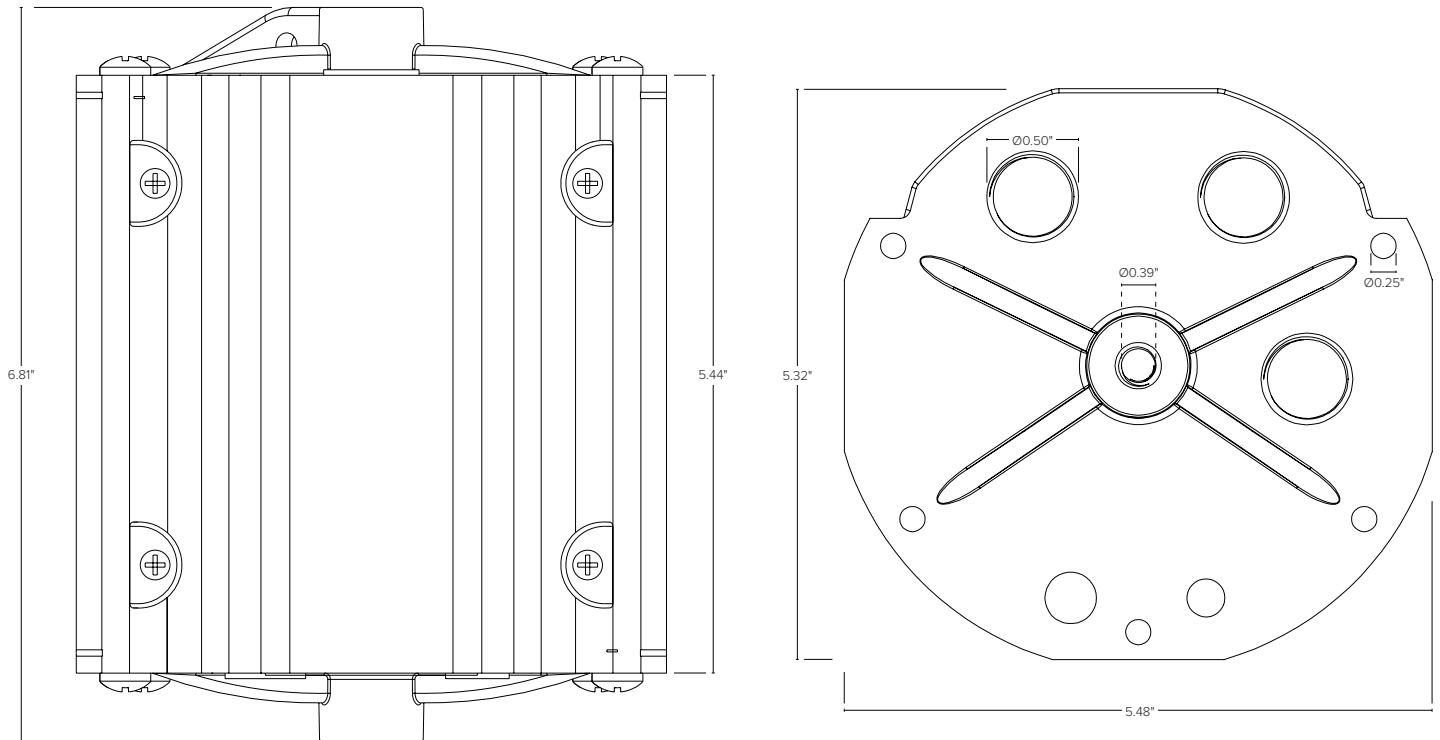

Loop
ESL-ACCS-LOOP-M10

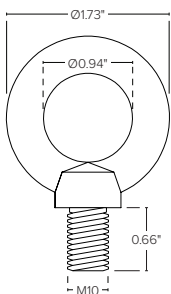

Hook
ESL-ACCS-HOOK-M10

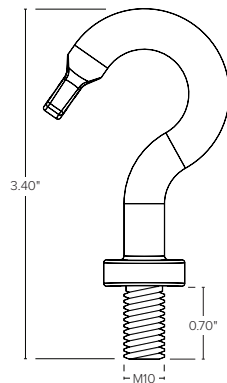

Wire Connector
ESL-ASMB-GLAND-PG11

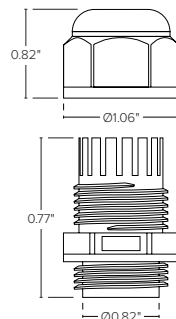

Connector
ESL-EMG-HB2-CONNECT-RODM10

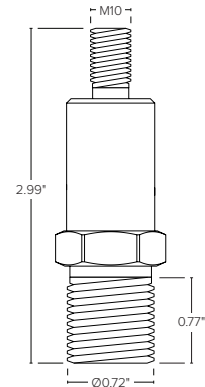

Wiring Diagrams:

Standard Installation

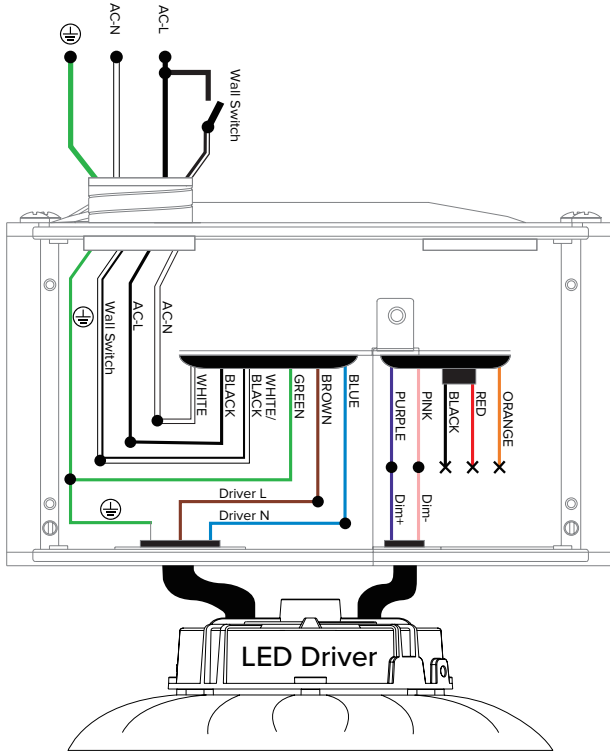

Dimmer Installation

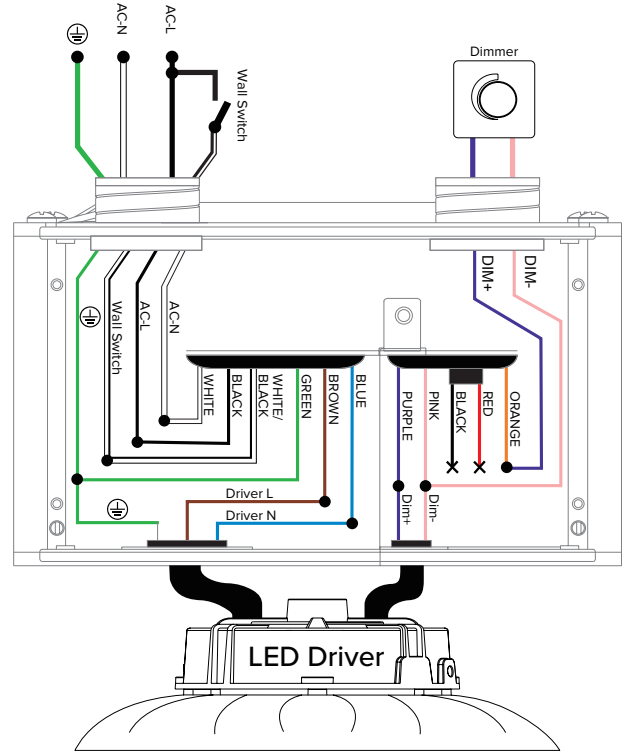

DC Sensor Installation

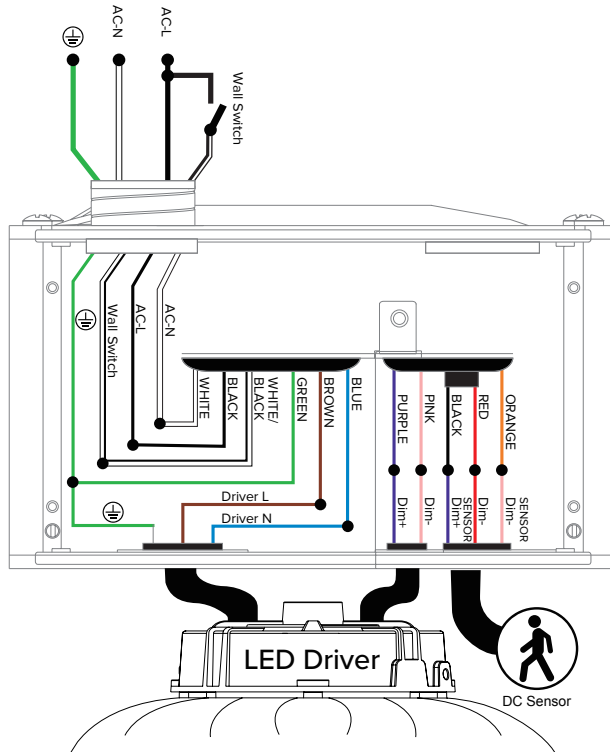

AC Sensor Installation

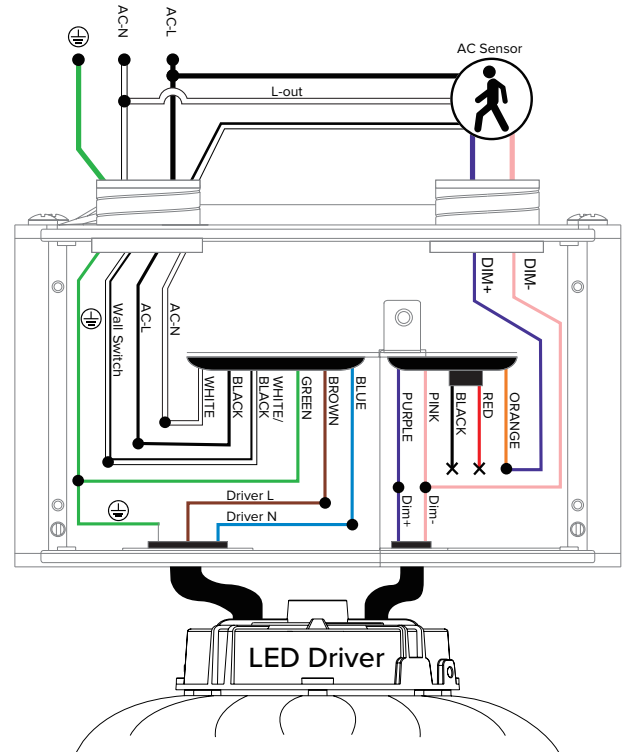

Wiring Diagrams:

Installation with KONEX Sensor

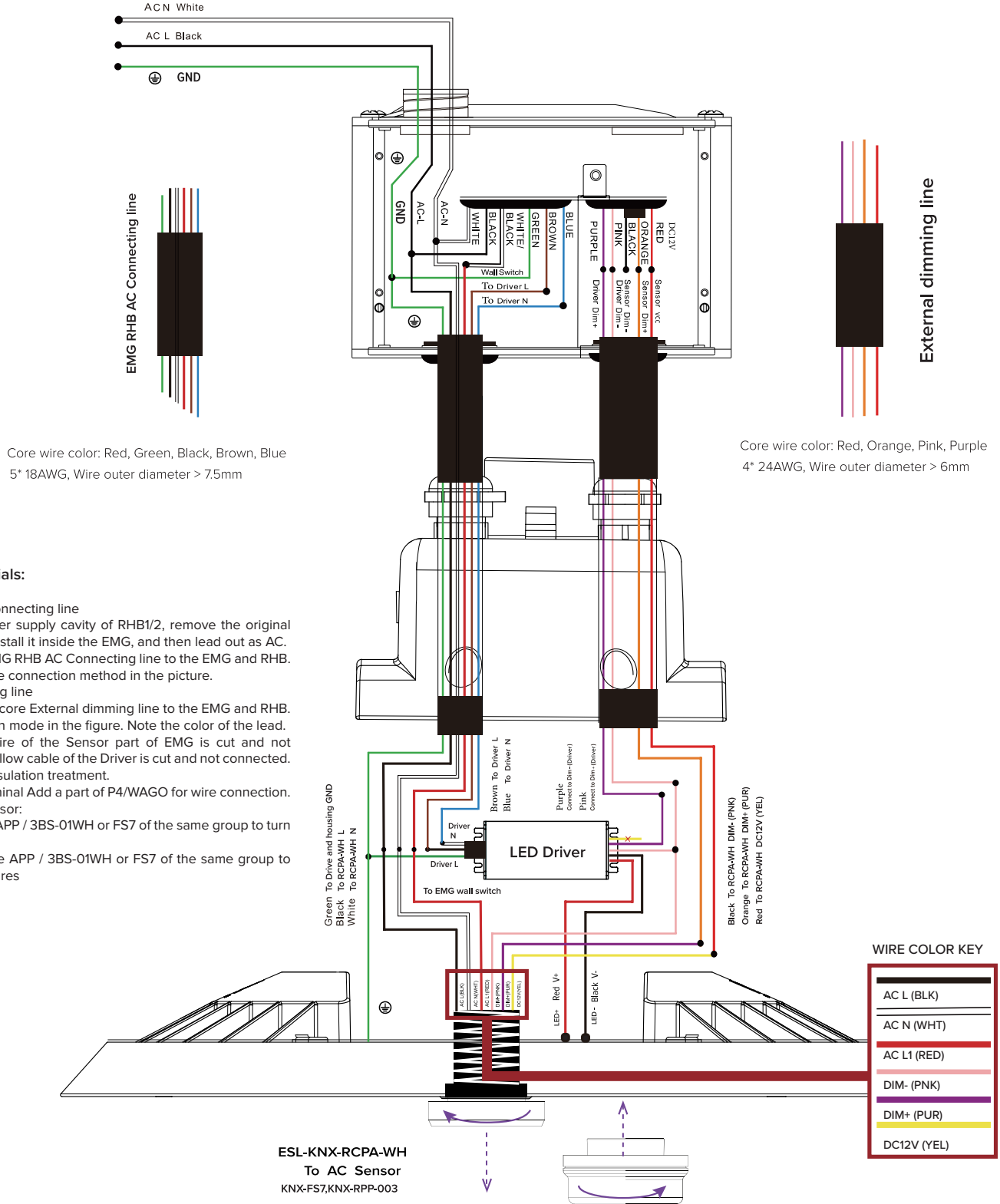

Additional Materials:

1. EMG RHB AC Connecting line
 - 1.1 Open the power supply cavity of RHB1/2, remove the original 5FT 3 core wire, install it inside the EMG, and then lead out as AC.
 - 1.2 Connect an EMG RHB AC Connecting line to the EMG and RHB. For details, See the connection method in the picture.
2. External dimming line
 - 2.1 Connect the 4-core External dimming line to the EMG and RHB. See the connection mode in the figure. Note the color of the lead.
 - 2.2 The black wire of the Sensor part of EMG is cut and not connected. The yellow cable of the Driver is cut and not connected. Pay attention to insulation treatment.
3. Connecting terminal Add a part of P4/WAGO for wire connection.
4. Use of KNX/Sensor:
 - 4.1 RPP-003: Use APP / 3BS-01WH or FS7 of the same group to turn off the luminaires
 - 4.2 KNX-FS7 : Use APP / 3BS-01WH or FS7 of the same group to turn off the luminaires