

### Key Features & Benefits:

- Kelvin Selectable
- Wattage Selectable
- Beam Angle Selectable
  - NEMA 4 & 5 Options
- Multiple Mounting Options in the Box:
  - Knuckle Mount
  - Trunnion Mount
- Integrated On/Off Photocell
- Durable Die-Cast Housing

### Product Specifications:

Selectable Wattage: 30W–40W–50W–60W  
 Selectable Kelvin: 3000K–4000K–5000K  
 Selectable Beam Angle: 55°–75°–90°  
 Lumens: Up to 9,000  
 Efficacy: Up to 150 lm/W  
 Input Voltage: 120–277 VAC  
 Input Frequency: 50/60 Hz  
 Dimming: 0–10V Dim to Off  
 Operating Temperature: -40°F to 122°F (-40°C to 50°C)  
 CRI: >80  
 Warranty: 5 Years  
 L70 Lifetime Calculated per TM21: 165,000 hrs  
 Dimensions (LxWxH): 7.8" x 7.2" x 3.4"  
 Weight (lbs): 2.51  
 Default Settings: 60W, 5000K & 90° Beam Angle  
 Default Photocell: On

Project: \_\_\_\_\_

Date: \_\_\_\_\_

Catalog #: \_\_\_\_\_

Notes: \_\_\_\_\_



### Ordering Guide:

ESL	TYPE	SELECTABLE WATTAGE	GENERATION	SELECTABLE KELVIN	FINISH
ESL	FLD	3060W	2	3050	WH

(FLD) Flood Light

(1020W) 10W–13W–17W–20W  
 (3060W) 30W–40W–50W–60W  
 (75150W) 75W–100W–125W–150W  
 (200320W) 200W–240W–280W–320W  
 (380500W) 380W–420W–450W–500W

(2) 2nd Gen

(3050) 3000K–4000K–5000K

(BZ) Bronze  
 (WH) White\*

\* White Finish is only available for 1020W and 3060W models

**Catalog Data:**

ITEM#	SELECTABLE WATTAGE	SELECTABLE KELVIN	SELECTABLE BEAM ANGLE	MAX LUMEN OUTPUT	MAX EFFICACY (lm/w)	FINISH	DIMENSIONS (LxWxH)	PHOTOCELL	DLC QPL CODE
ESL-FLD-1020W-23050-XX	10W-13W-17W-20W	3000K-4000K-5000K	55°-75°-90°	3,000	150	Bronze, White*	6.3" x 5.2" x 2.7"	Integrated On/Off	S-TNN3BJ
ESL-FLD-3060W-23050-XX	30W-40W-50W-60W			9,000	150	Bronze, White*	7.8" x 7.2" x 3.4"	Integrated On/Off	S-V4GN06
ESL-FLD-75150W-23050-BZ	75W-100W-125W-150W			22,500	150	Bronze	11.2" x 7.3" x 7.0"	Integrated On/Off	S-9WZW4H
ESL-FLD-200320W-23050-BZ	200W-240W-280W-320W			48,000	150	Bronze	16.63" x 10.3" x 8.5"	Twist Lock On/Off	S-QJTT5K
ESL-FLD-380500W-23050-BZ	380W-420W-450W-500W			75,000	150	Bronze	19.5" x 14.19" x 9.69"	Twist Lock On/Off	S-82Y0KQ

\* White Finish is only available for 1020W and 3060W models

**Dimensions:**

**ESL-FLD-1020W-23050-XX**

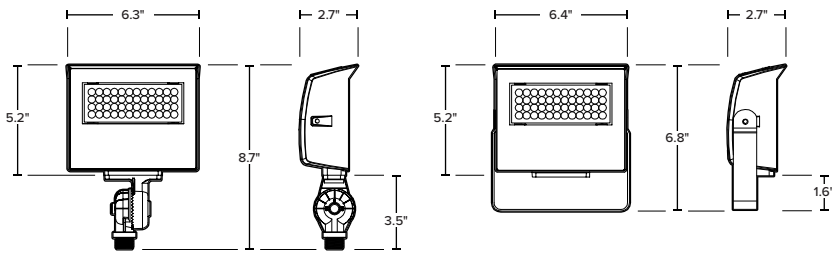

**ESL-FLD-3060W-23050-XX**

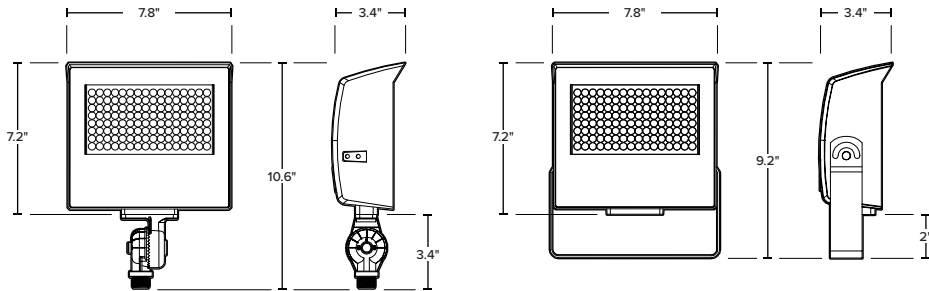

**ESL-FLD-75150W-23050-BZ**

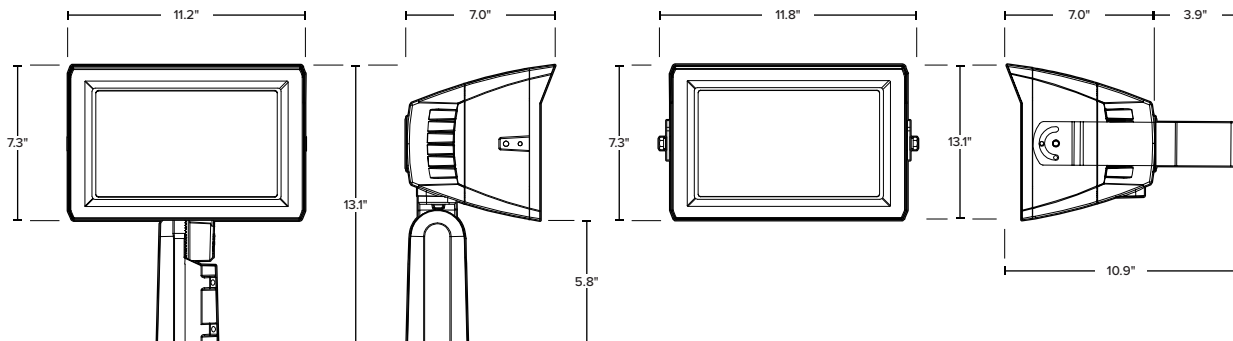

**Dimensions:**

**ESL-FLD-200320W-23050-BZ**

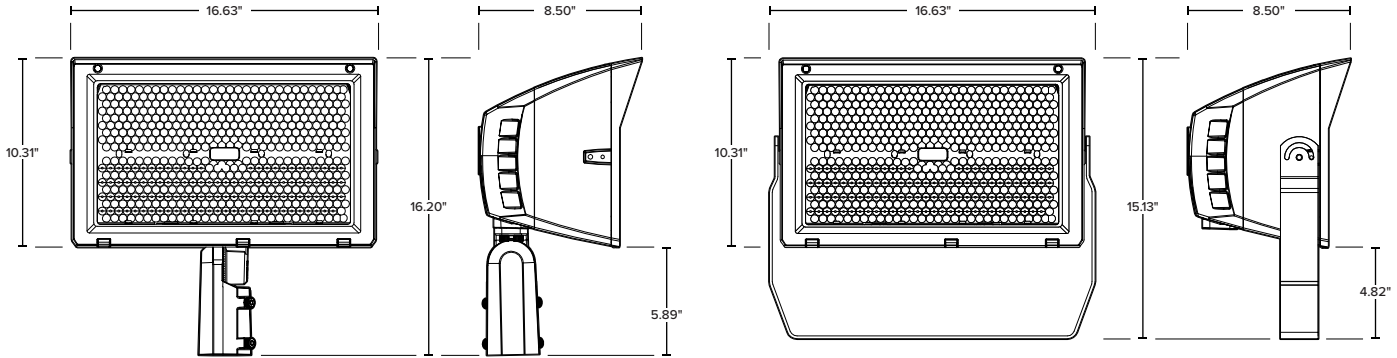

**ESL-FLD-380500W-23050-BZ**

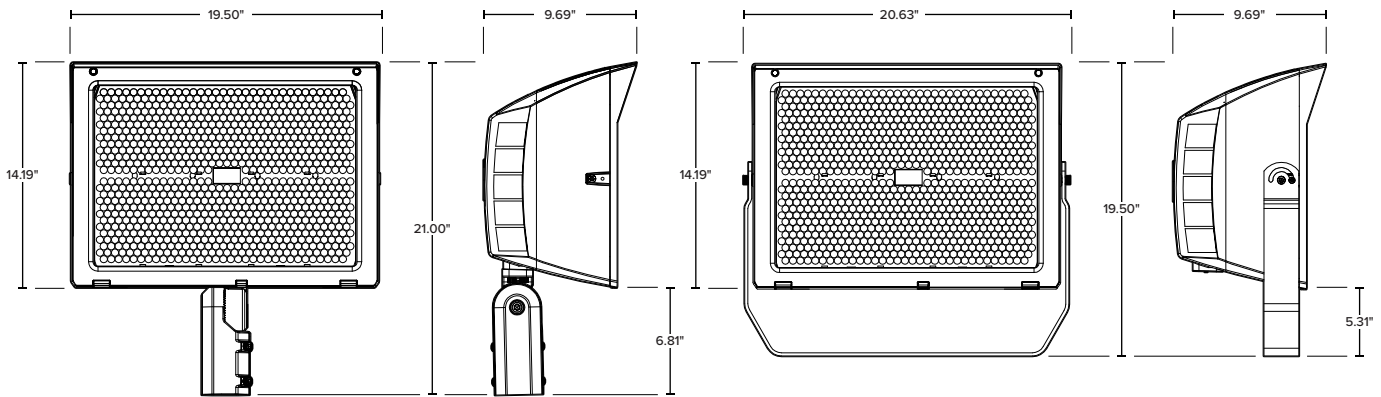

**Mount Dimensions:**

**MOUNTS INCLUDED WITH  
ESL-FLD-1020W-23050-XX & ESL-FLD-3060W-23050-XX**

**Knuckle Mount**

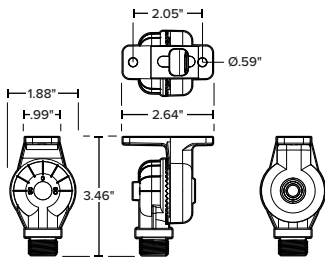

**Trunnion Mount**

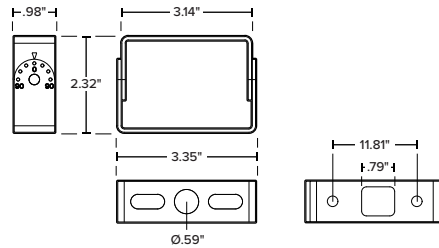

**Mount Dimensions:**

**MOUNTS INCLUDED WITH  
ESL-FLD-75150W-23050-BZ**

**Slip Fitter Mount**

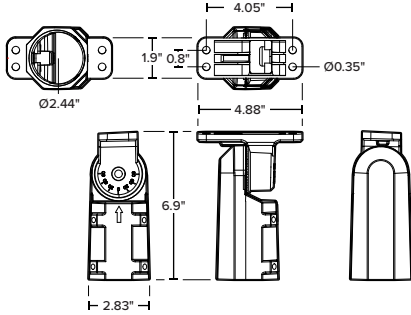

**Yoke Mount**

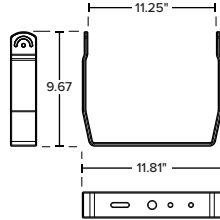

**MOUNTS INCLUDED WITH  
ESL-FLD-200320W-23050-BZ**

**Slip Fitter Mount**

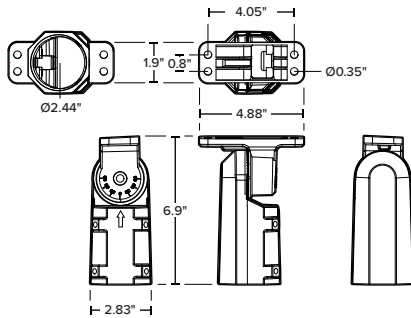

**Yoke Mount**

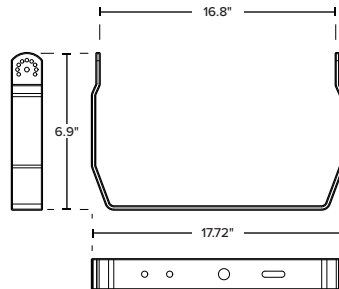

**MOUNTS INCLUDED WITH  
ESL-FLD-380500W-23050-BZ**

**Slip Fitter Mount**

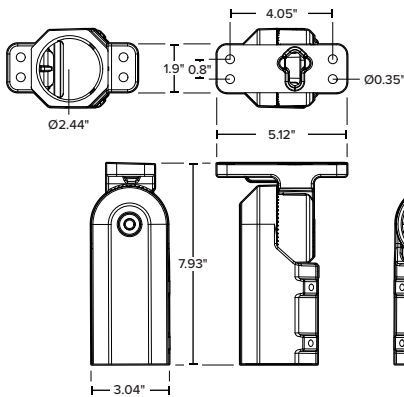

**Yoke Mount**

