

TOPSLIDE®

INTERNATIONAL

5819

Full Extension Slide
Heavy Duty Slide

Applications:

- Contract office
- Automotive
- Medical furniture

Features:

- Up to 100kg load rating
- Full extension
- Positive stop
- Detent-in
- Trigger disconnect
- Side mounted
- Non handed
- 32mm system hole pattern
- Zinc finish

Options:

- Available with bayonet tabs
- Self closing feature
- Sizes: 250mm - 1500mm

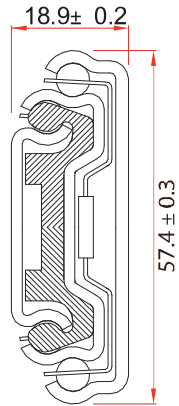
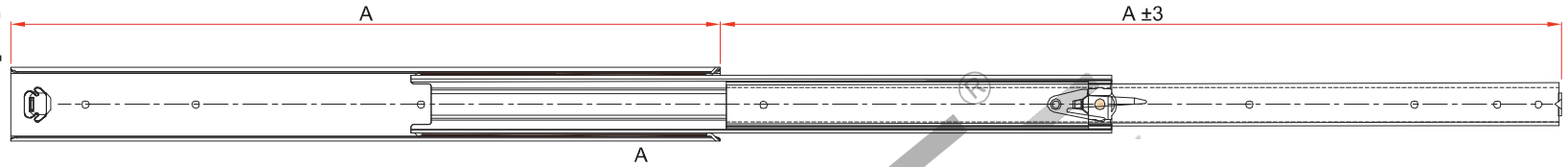

A	B	C	D	E	F	G	H	Kg
250	192			243	192			75
300	224	32		293	224			80
350	224	64		343	228			90
400	224	128		393	224	320		100
450	224	160		443	224	384		100
500	224	160	64	493	192	320	448	100
550	224	160	96	543	224	352	480	100
600	224	160	160	593	224	384	544	100
650	224	192	160	643	224	384	576	100
700	224	192	224	693	224	416	640	95
750	224	224	256	743	224	448	672	95
800	224	224	288	793	256	480	736	90
850	288	256	256	843	288	544	768	90
900	288	256	288	893	288	544	832	80
950	320	288	288	943	320	608	864	80
1000	350	228	228	993	320	578	928	80
1050	352	352	320	1043	352	608	800	75
1100	352	384	352	1093	320	608	832	75
1150	352	384	352	1043	320	640	864	75
1200	352	288	288	1193	320	512	704	75
1250	320	256	256	1243	320	544	768	75
1300	320	256	256	1293	320	576	800	75
1350	320	256	256	1343	320	576	832	75
1400	320	256	256	1393	320	576	896	75
1450	320	288	288	1443	320	608	928	75
1500	320	288	288	1493	320	608	960	75

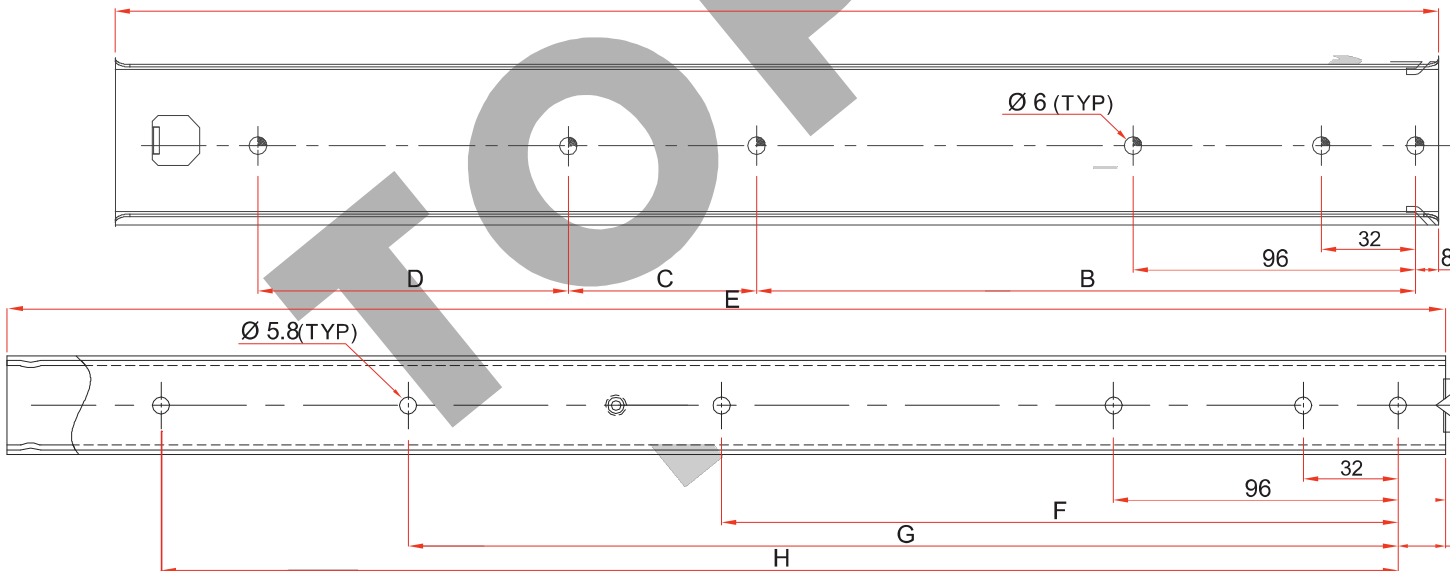

Model No. 5819
Full Extension Slide

Ver.3,2.06-08-2020

© TOPSLIDE International

TOPSLIDE reserve the right to amend specifications without notice.