

---

## Multi Frequency Band Antennas

---

- **Vehicle tracking**
- **Asset tracking**
- **GPS Navigation**
- **Wifi**
- **Telemetry**

ADA-0400/1400 is a range of multi- frequency antennas for GSM, 3G, GPS and Wifi. The ADA-0400/1400 antennas are available in centre bolt, magnet mount as well as tape mount versions.



## Specification

Category	GPS
Frequency	1575.42 MHz
Polarization	R.H.C.P.
Power Gain	Typ. 27 dB
Noise figure	Max 1.8
Attenuation	Min. 20 dB @ Fo ± 50 MHz
Bandwidth	2 MHz
Output Impedance	50 Ω
VSWR	<= 2.0
Supply Voltage /Current	3.0 – 5.5 VDC / 12 mA
RF Cable	Standard 3 m RG174/U with standard connector
	<b>GSM/UMTS/2400</b>
Frequency	824 ~ 894 MHz (GSM 850MHz) 890 ~ 960 MHz (GSM 900MHz) 1710 ~ 1890 MHz (GSM 1800MHz) 1850 ~ 1990 MHz (PCS 1900MHz) 1922 ~ 2170 MHz (3G 2100 MHz) 2400 ~ 2483 MHz (2400 MHz)
Polarization	Vertical Linear
Gain	850 MHz= 1.0 dBi    900 MHz= 1.0 dBi 1800 MHz= 1.0 dBi    1900 MHz= 1.0 dBi 2100 MHz= 0.0 dBi    2400 MHz= 0.0 dBi
Impedance	50 Ω
VSWR	<= 2.0
Power	10 W
RF Cable	Standard 3 m RG174/U with standard connector
	<b>Overall Performance</b>
Size	63 x 15.6 mm (D x H)
Mounting	Centre bolt or magnetic
Operating temperature	-40 — +80 ° C
Storage temperature	-45 — +100 ° C

850MHz

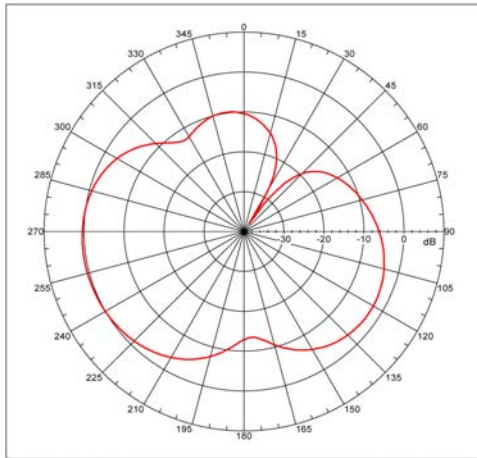

1900 MHz

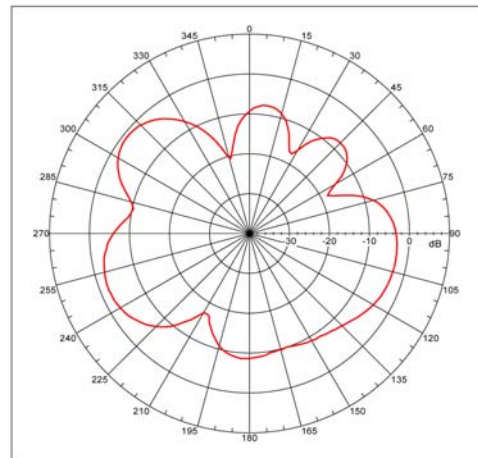

900 MHz

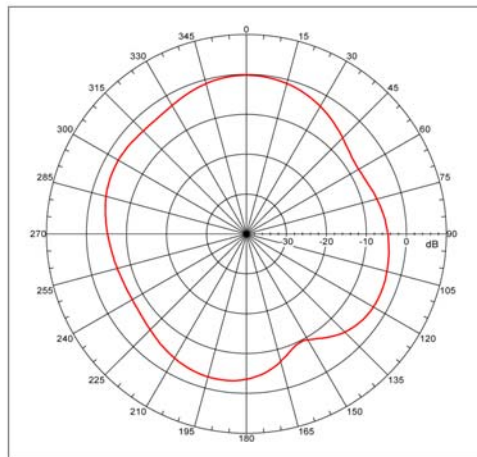

2100 MHz

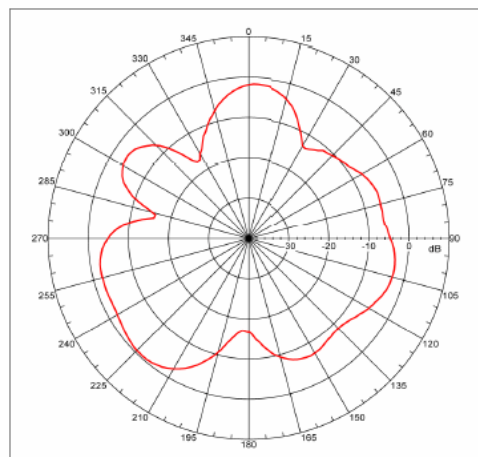

1800 MHz

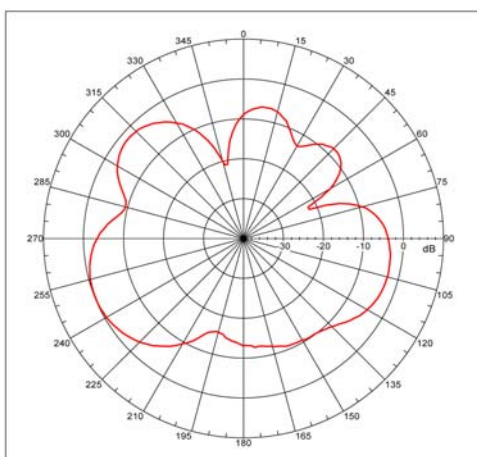

2400 MHz

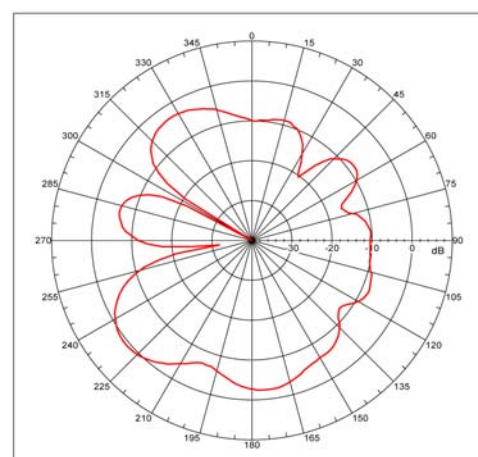

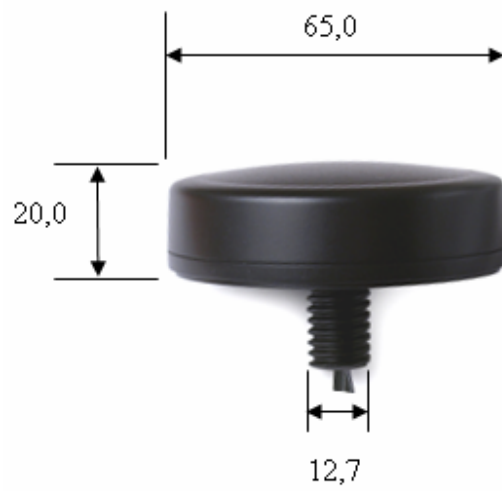
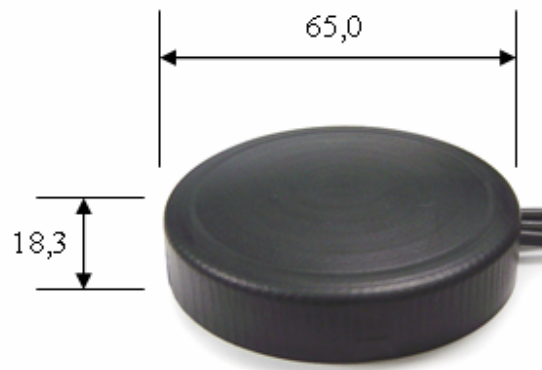

## Ordering codes

TYPE	GPS	850	900	1800	1900	2100	2400	No of cables
ADA-0410-x			X	X				1
ADA-0420-x		X			X			1
ADA-0430-x		X	X	X	X			1
ADA-0440-x		X	X	X	X	X		1
ADA-0450-x		X	X	X	X	X	X	2
ADA-0460-x							X	1
ADA-1410-x	X		X	X				2
ADA-1420-x	X	X			X			2
ADA-1430-x	X	X	X	X	X			2
ADA-1440-x	X	X	X	X	X	X		2
ADA-1450-x	X	X	X	X	X	X	X	3
ADA-1460-x	X						X	2
ADA-1470-x	X							1

x = C for Centre bolt mount  
 S for Magnetic mount  
 T for tape mount

The antennas are delivered with different antenna cable lengths and different connectors. Contact Adactus or our distributor for a quote for any particular specification.

For the latest updates, visit our Web site: [www.adactus.se](http://www.adactus.se)

### **Disclaimer**

Information furnished is believed to be accurate and reliable. However, Adactus assumes no responsibility for the consequences of use of such information nor for any infringement of patents or other rights of third parties which may result from its use. Adactus reserves the right to make changes without further notice to any product herein to improve reliability, function or design. Adactus does not assume any liability arising out of the application or use of any product described herein. This publication supersedes and replaces all information previously supplied. Adactus products are not authorized as critical components in life support devices or systems.