

### GSM DIPOLE ANTENNA

---

- **GSM dipole antenna**
- **Multi frequency band**
- **On glass mount**
- **2 dBi Gain**

ADA-0062 is an on glass dual band GSM dipole antenna with SMA or FME connector, delivered with 2.5 m RG174 cable.

ADA-0062Q is a quad band GSM antenna, but in all other aspects similar to ADA-0062.

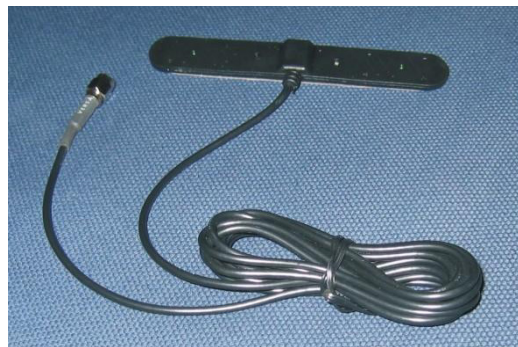

### Specification ADA-0062

Category	Overall performance
Frequency	GSM 900 / 1800 MHz
Impedance	50 $\Omega$
Gain	2dBi
Connector	SMA Male or FME

### Specification ADA-0062Q

Category	Overall performance
Frequency	GSM 850/ 900 / 1800 / 1900 MHz
Impedance	50 $\Omega$
Gain	2dBi
Connector	SMA Male or FME

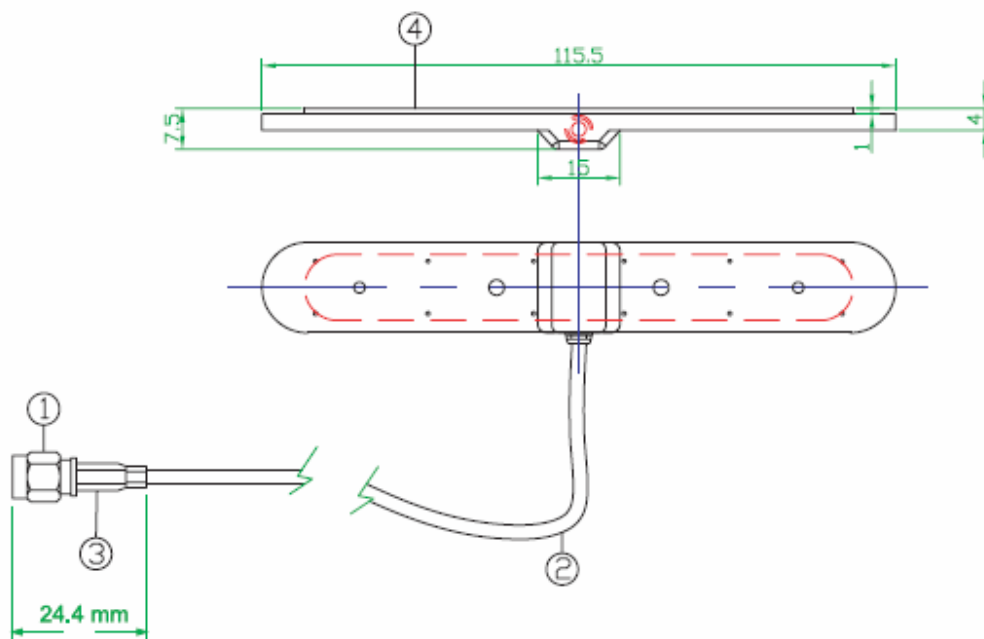

# ADA-0062

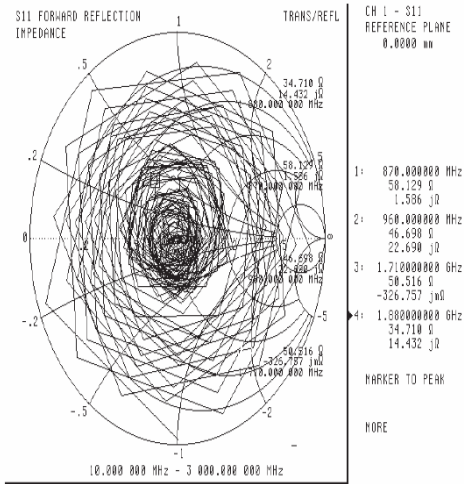

# ADA-0062Q

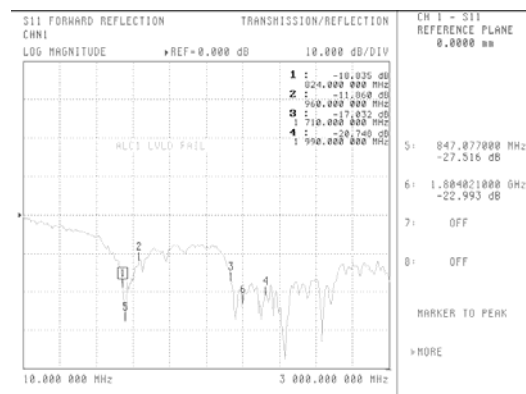
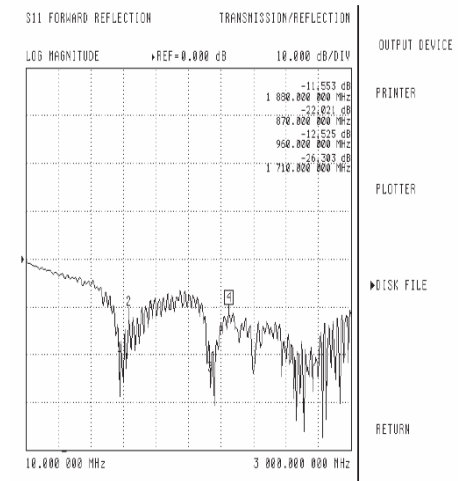
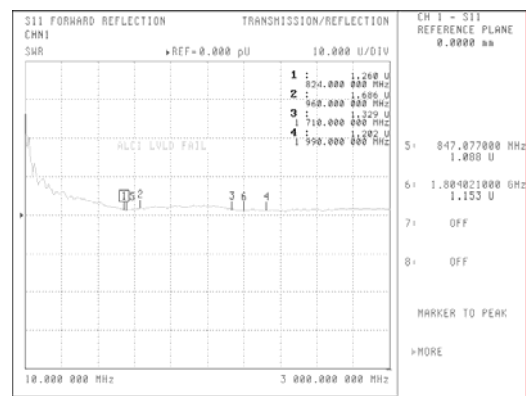
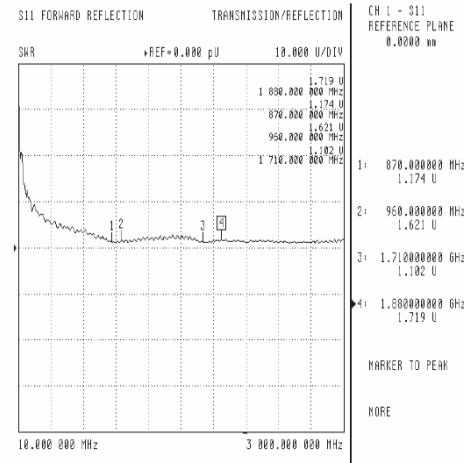
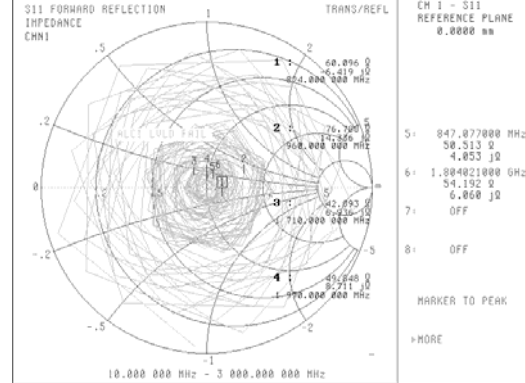

## Ordering codes

TYPE	Description	Comment
ADA-0062	GSM dipole antenna	Dual band
ADA-0062Q	GSM dipole antenna	Quad band

For the latest updates, visit our Web site: [www.adactus.se](http://www.adactus.se)

### **Disclaimer**

Information furnished is believed to be accurate and reliable. However, Adactus assumes no responsibility for the consequences of use of such information nor for any infringement of patents or other rights of third parties which may result from its use. Adactus reserves the right to make changes without further notice to any product herein to improve reliability, function or design. Adactus does not assume any liability arising out of the application or use of any product described herein. This publication supersedes and replaces all information previously supplied. Adactus products are not authorized as critical components in life support devices or systems.