

GPS / GSM combo antenna

- **GPS Active Antenna**
- **27dB Gain**
- **GSM/GPRS antenna**
- **900/1800 MHz
(800/1900)**
- **Sticky tape mounting**



ADA-0112 is a combined active GPS and GSM/GPRS antenna.

The GPS part is an active antenna with 27 dB gain.

The GSM part is a dual frequency band antenna.

ADA-0112 is delivered with a sticky tape for mounting, and is complete with cables and connectors.

Specification

Category	GPS
Frequency	1575.42 MHz
Polarization	R.H.C.P.
Power Gain	Typ. 32 dB
Noise figure	Max 1.8 @ +30 °C
Attenuation	Min. 20 dB @ $F_o \pm 50$ MHz
Bandwidth	2.2 MHz
Output Impedance	50 Ω
VSWR	Max 2.0:1
Supply Voltage /Current	2.5 – 5.5 VDC / 10-25 mA
RF Cable	Standard 3 m RG174/U with standard connector
	GSM
Frequency	900 MHz / 1800 MHz (800/1900)
Polarization	Vertical
Gain	2.5 dBi
Impedance	50 Ω
VSWR	1.5 : 1
Power	10 W
RF Cable	Standard 3 m RG174/U with standard connector
	Overall Performance
GPS part size	59.8 x 16 mm
GSM part length	110 mm (option available)
Mounting	Sticky tape
Operating temperature	-40 — +80 ° C
Storage temperature	-40 — +90 ° C

1575 MHz

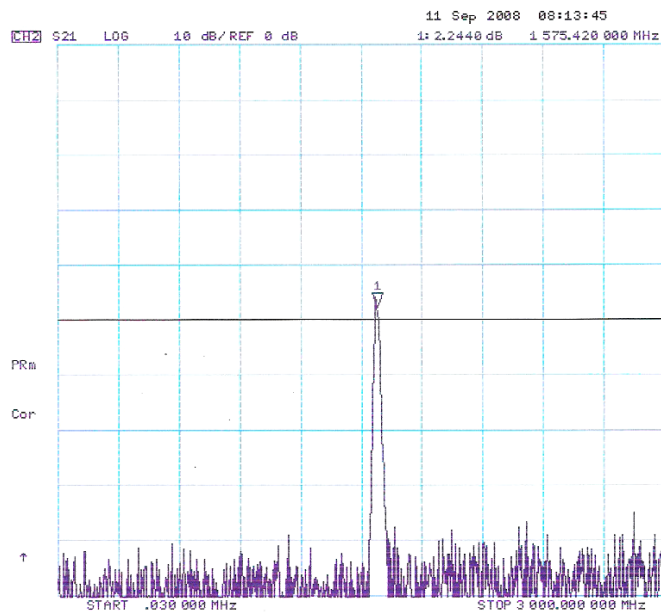
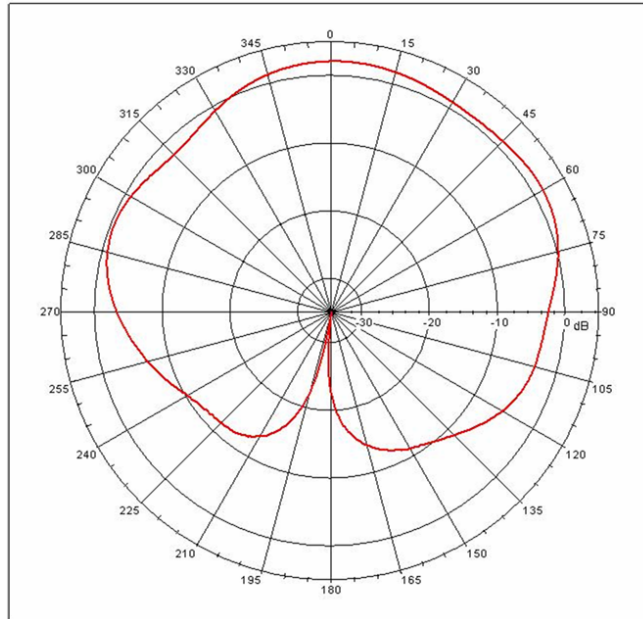

880 MHz

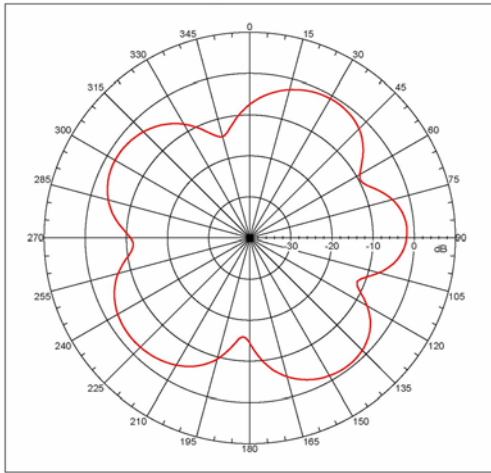

1710 MHz

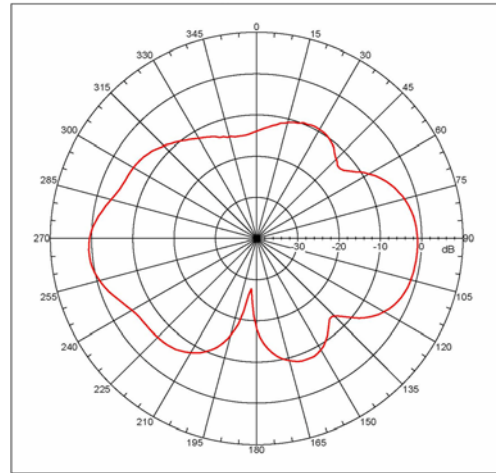

960 MHz

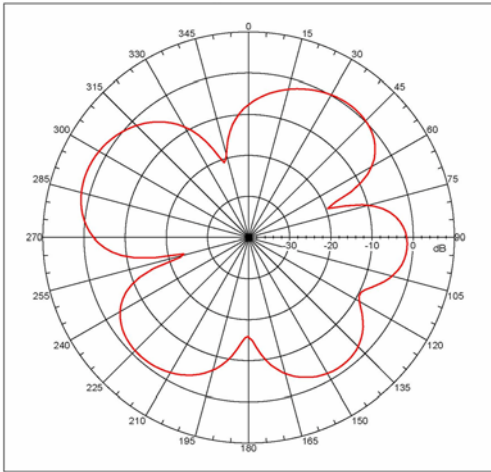

1800 MHz

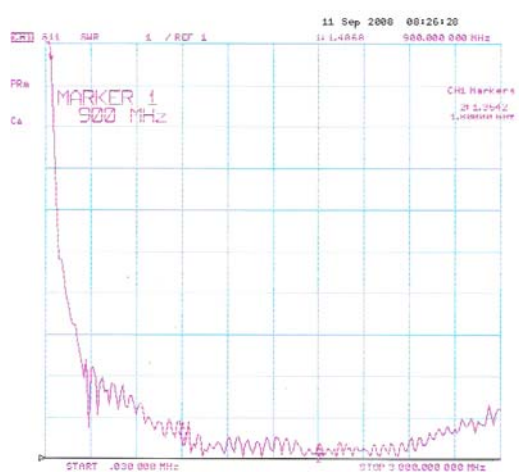
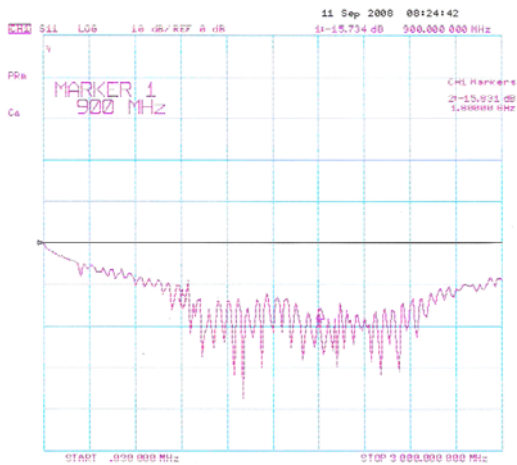
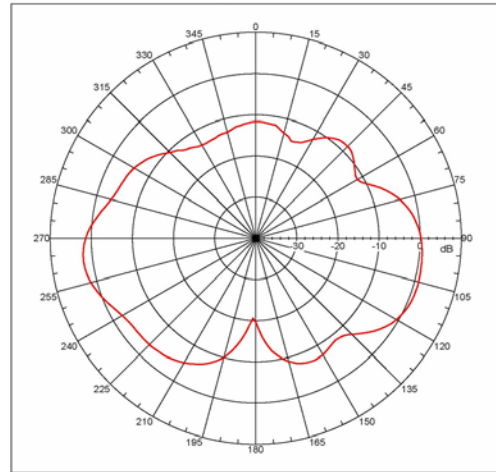

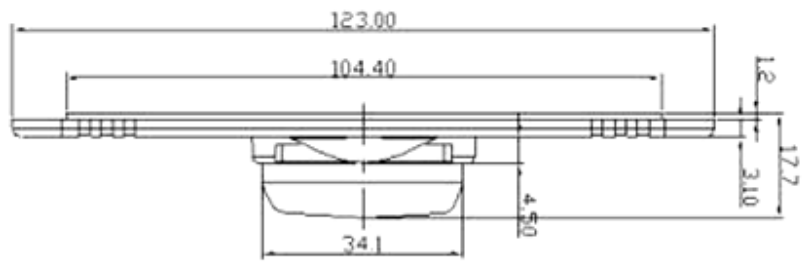
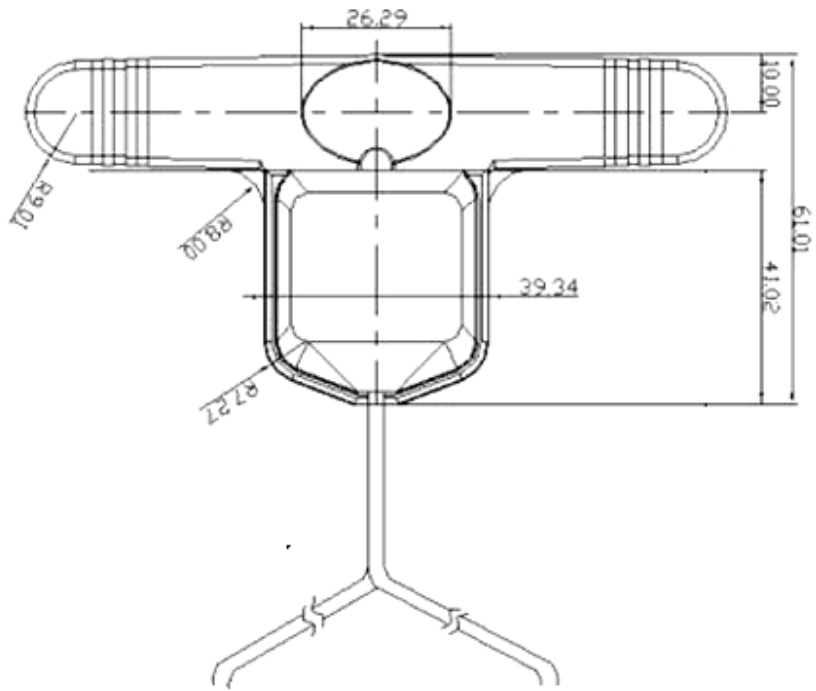

Ordering codes

TYPE	Description	Comment
ADA-0112	Standard cable length	GPS/GSM combo antenna

For the latest updates, visit our Web site: www.adactus.se

Disclaimer

Information furnished is believed to be accurate and reliable. However, Adactus assumes no responsibility for the consequences of use of such information nor for any infringement of patents or other rights of third parties which may result from its use. Adactus reserves the right to make changes without further notice to any product herein to improve reliability, function or design. Adactus does not assume any liability arising out of the application or use of any product described herein. This publication supersedes and replaces all information previously supplied. Adactus products are not authorized as critical components in life support devices or systems.