





**LED FLAT PANEL SURFACE MOUNT
AR-SMLPB114A - AR-SMLPB122A - AR-SMLPB124A**

**PLEASE READ THESE INSTRUCTIONS CAREFULLY BEFORE INSTALLATION
LEAVE A COPY FOR THE USER / MAINTENANCE ENGINEER FOR FUTURE REFERENCE**

IMPORTANT INSTALLATION INFORMATION

 <p align="center">WARNING RISK OF ELECTRIC SHOCK</p> <ul style="list-style-type: none"> • Disconnect power before performing installation or maintenance. • Verify that supply voltage is correct by comparing it with the luminaire label information. • Make all electrical grounded connections in accordance with the latest edition of the National Electrical Code (NEC) and applicable local code requirements. • If the supply wire is damaged, it must be replaced by the manufacturer or their service agent or a similar qualified person in order to avoid a hazard. • All wiring connections should be capped with UL approved wire connections. • To reduce the risk of fire or electrical shock, do not expose this apparatus to rain or moisture. 	 <p align="center">WARNING CAUTION</p> <ul style="list-style-type: none"> • Do not dispose of electrical appliances as unsorted municipal waste, use separate collection facilities. • If electrical appliances are disposed of in landfill or dumps, hazardous substances can be damaging to health and well-being. • Contact your local government for information regarding the collection system available. • This device is not intended for use with emergency exit fixtures or emergency exit lights. • To reduce the risk of electrical shock, do not remove cover and caps, fitting must be grounded. • No user-serviceable parts inside. • Do not use when enclosure is broken. • To prevent wiring damage or abrasion does not expose wiring to edges of sheet metal or other sharp objects. • Indoor use only. • This product must be installed in accordance with the applicable installation code by a person familiar with the construction and operation of the product and hazards involved.
 <p align="center">WARNING RISK OF BURNS</p> <ul style="list-style-type: none"> • Follow all manufacturer's warnings and recommendations for the driver type, mounting position, methods, replacement and recycling. 	 <p align="center">WARNING RISK OF FIRE</p> <ul style="list-style-type: none"> • Keep any combustible and other materials that can burn away from the luminaire. • Incorrect installation may result in electrical shock or a risk of a fire.

For Models:

1x4 AR-LP114AD/XX AR-LP114BD/XX* AR-LP114BDD/XX*
2x2 AR-LP122AD/XX AR-LP122BD/XX* AR-LP122BDD/XX*
2x4 AR-LP124AD/XX AR-LP124BD/XX* AR-LP124BDD/XX*

***Also for use with EM Option**

IMPORTANT: READ CAREFULLY BEFORE INSTALLING. RETAIN FOR FUTURE REFERENCE.

Materials Included:

- Surface Mount x 1
- Surface Mount End Cap x 1
- End Cap Screws x 2

Additional Materials Required:

- Mounting Screws and Anchors*
 - o AR-SMLPB114A x 8
 - o AR-SMLPB122A x 6
 - o AR-SMLPB124A x 8
- AC Power Whip may also be required

*Screw and anchor type depends on the type of ceiling the surface mount is being mounted to and is the responsibility of the installer.

Installation Instructions

- Determine mounting location & secure the Surface Mount to the ceiling using hardware appropriate for the ceiling type (**Figure 3**).
- Wire power supply to panel in accordance with Panel Installation Instructions and the National Electrical Code.
Note: A power whip may be required to properly wire the power supply to the panel.
- Slide wired panel into the surface mount through the open end (**Figure 4**).
- Close the Surface Mount using the Surface Mount End Cap (**Figure 5**) & secure using the two screws provided

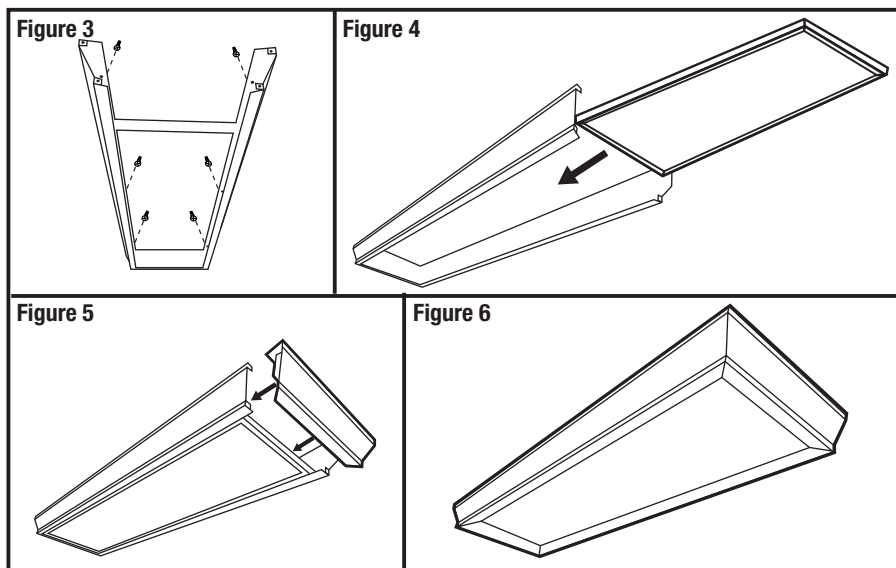
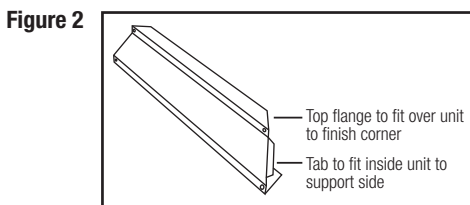
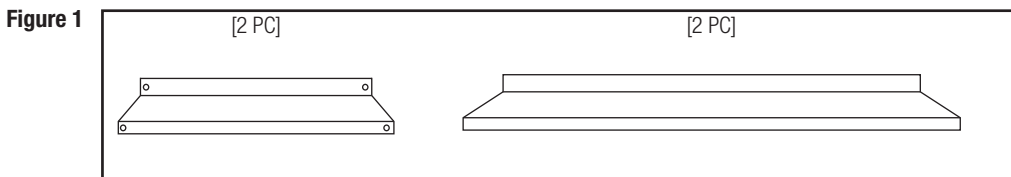

WARRANTY:

This product has a warranty of period of 1 years from the date of purchase. The warranty is invalid in the case of improper use, installation, tampering, and removal of the Q.C. date label, installation in an improper working environment or installation not according to the current edition of the National Electric Code. Should this product fail during the warranty period it will be replaced free of charge, subject to correct installation and return of the faulty unit. Aurora does not accept responsibility for any installation costs associated with the replacement of this product. This warranty is in addition to the statutory rights in your country of purchase. Aurora reserves the right to alter specifications without prior notice.