

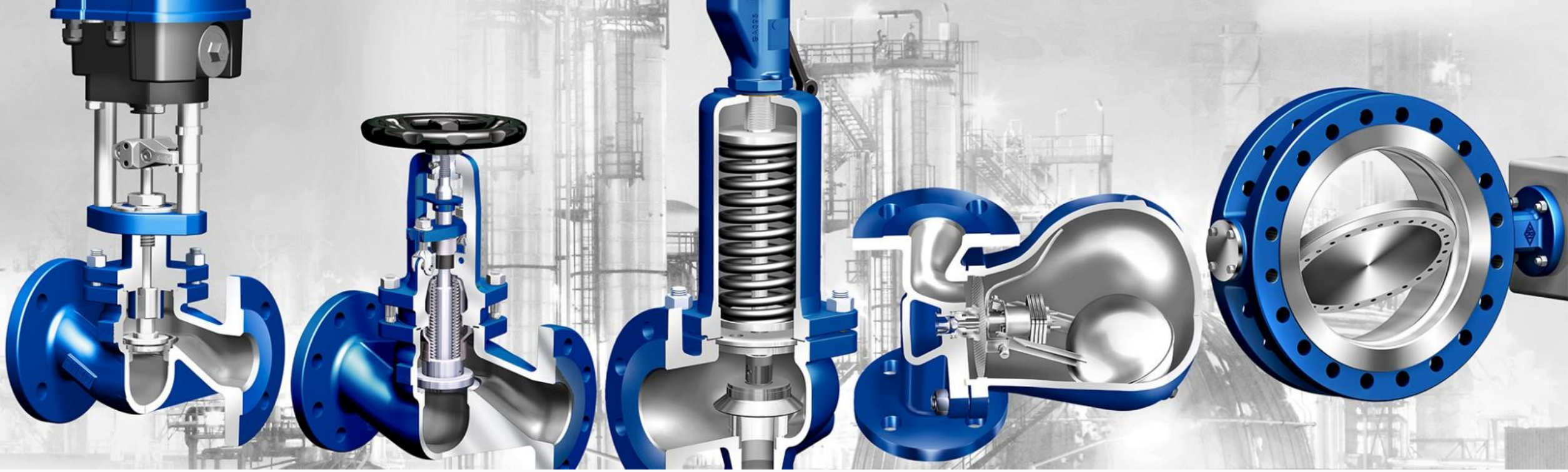

ARI-Armaturen Albert Richter GmbH & Co. KG



Your Partner for Control, Isolation, Safety, Steam Trapping and Engineered Systems

ARI-Armaturen is a leading international developer, manufacturer and distributor of valves as well as complementary services linked to the control, isolation, safety and steam trapping of liquid and gaseous media.



Key Milestones in the ARI Success Story

- ▶ 1950 Formation of ARI-Armaturen GmbH & Co.KG by Albert Richter
- ▶ 1952 Acquisition of the company by Brechmann-Guss GmbH & Co. KG
- ▶ 1969 New facility opens in Homberg / Efze
- ▶ 1970 New ARI products: FABA stop valves and STEVI control valves
- ▶ 1980 New ARI product: SAFE safety valves
- ▶ 1988 New ARI product: ASTRA flow regulating valves
- ▶ 1999 AWH Armaturenwerke Halle GmbH joins the ARI group
- ▶ 1999 New addition to the ARI portfolio: CONA steam traps
- ▶ 2002 Acquisition of Wittler Armaturen GmbH
- ▶ 2008 New application engineering technology: PRESys, CORsys, ENCOsys
- ▶ 2011 Acquisition of Comeval S.L., Spain
- ▶ 2012 Acquisition of Valvosteel s.r.l., Italy
- ▶ 2012 New ARI product: ZETRIX process valves
- ▶ 2013 Acquisition of AR Safety Systems and their full line of API safety relief valves
- ▶ 2014 Acquisition of Steamline in India
- ▶ 2015 Portfolio Extension: ZETRIX double flange 28"-48", lug type up to 24"
- ▶ 2016 Acquisition of Bermo Válvulas e Equipamentos Industriais Ltda, Brazil
- ▶ 2018 Finished construction of new facility ARI-India
- ▶ 2019 Extension of HQ building and production capacity at Homberg facility
- ▶ 2019 Acquisition of Högfors Oy, Finland
- ▶ 2022 Acquisition of Colin Swiss, Switzerland



Success Rooted in the Local Region – on the Edge of the Famous Teutoburg Forest

- ▶ Privately owned SME
- ▶ Headquarters in Schloß Holte-Stukenbrock (close to Bielefeld)
- ▶ All manufacturing operations concentrated at three locations in Germany
- ▶ Sales subsidiaries in Austria, Denmark, Sweden, Finland, the UK, France, Spain, Italy, Switzerland, India, Malaysia, Singapore, China, Korea, the USA, Brazil, Dubai
- ▶ Steadily expanding network of sales partners with currently more than 60 agents worldwide
- ▶ More than 1000 employees around the globe
- ▶ Sales of approx. 175 million euros



Your Strong Partner Worldwide with 18 Branch Offices and Sales Partners in More than 60 Countries

- Argentina • Australia • **Austria** ARI-Armaturen GmbH • Belgium • **Brazil** - Bermo Válvulas e Equipamentos Industriais Ltda • Bolivia • Canada • Chile • Colombia • Croatia
- Cyprus • Czech Republic • **Denmark** ARI-Armaturen A/S • Dom.Rep. • Egypt • Estonia • Ecuador • El Salvador • **Finland** Högfors Oy • **France** ARI-Armaturen France SARL
- **Germany** ARI-Armaturen Albert Richter GmbH & Co. KG - AWH Armaturenwerk Halle - Wittler Armaturen GmbH • Greece • Guatemala • Honduras • Hungary • **India** ARI-Armaturen Steamline LLP
- Israel • **Italy** ARI-Armaturen Italia S.r.l & C.S.a.s. • Jordan • Kenya • **Korea** ARI-Armaturen Korea Ltd. • Kuwait • Latvia • Lebanon • Lithuania • **Malaysia** ARI-Armaturen Sdn. Bhd. • Mexico
- Morocco • Netherlands • New Zealand • Norway • Oman • Peru • Poland • Portugal • **P.R. China** ARI-Armaturen Shanghai Ltd • Qatar • Romania • Saudi Arabia • **Singapore** ARI-Armaturen Pte. Ltd.
- Slovakia • Slovenia • South Africa • **Spain** Comeval Valve Systems, S.L.y Cia., Sociedad Comanditaria • Syria • **Sweden** ARI Armaturen Sweden • **Switzerland** Colin Swiss AG • Taiwan
- Thailand • Tunisia • Turkey • **UAE / Dubai** ARI-Armaturen Middle East FZE • Ukraine • **USA** ARI-Armaturen USA LP • **United Kingdom** ARI-Armaturen UK Ltd. • Uruguay



We Offer an Extraordinary Wide Range of Products for...

Industry

- ▶ Food and beverages
- ▶ Power plants & renewable energy
- ▶ Steelworks
- ▶ District heat
- ▶ Building materials
- ▶ Wood, pulp and paper
- ▶ Tyres
- ▶ Hot water & steam
- ▶ Thermal oil
- ▶ Refrigeration

Chemical Industry

- ▶ Organic chemicals
- ▶ Alcohols
- ▶ Polymers

Plant engineering

- ▶ Power plants
- ▶ Oil & gas
- ▶ Metallurgy
- ▶ Paper
- ▶ Engineered wood manufacturing

Shipbuilding

- ▶ Cooling water systems
- ▶ Ballast water systems
- ▶ Exhaust gas and auxiliary boilers
- ▶ HVAC systems

HVAC

- ▶ Heating
- ▶ Air conditioning and cold water
- ▶ District heat
- ▶ Hot water & steam

One-Stop-Shop – Our Philosophy, Your Satisfaction

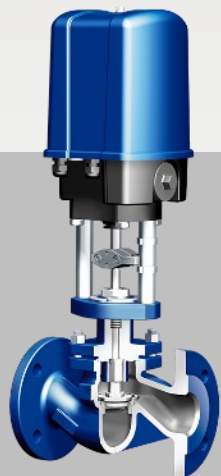

Control

STEVI® Smart
 STEVI® Vario
 STEVI® Pro
 STEVI®-H
 PRESO®
 PREDEX®
 PREDU®
 TEMPTROL®
 Electric actuator PREMIO
 Pneumatic actuator DP

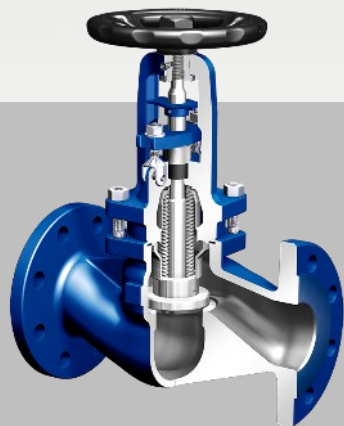

Isolation

ASTRA®
 ASTRA®-Plus
 EURO-WEDI®
 FABAs®-Plus /-Supra STOBU®
 ZETRIX®
 ZIVA®
 ZESA®
 GESA®
 CHECKO®-D / -V
 Strainer

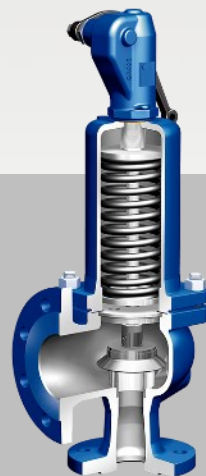

Safety

DIN EN ISO 4126
 SAFE
 SAFE-P
 SAFE-TC
 SAFE-TCP/TCS

ASME Sec. VIII / API526
Full Nozzle:
 REYCO® R
 REYCO® RL14
 REYCO® RL40/41
Semi Nozzle:
 SAFE-SN

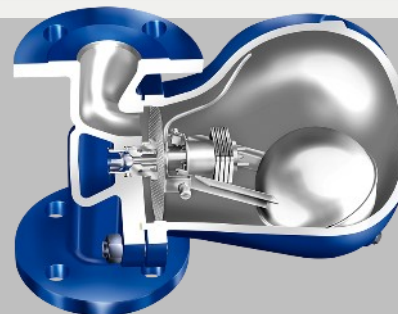

Steam Trapping

CONA® B
 CONA® M
 CONA® SC / SC-Plus
 CONA® S
 CONA® TD
 CODI®
 CONA® Universal
 CONA® Connector
 CONA® All-in-one
 CONA® control

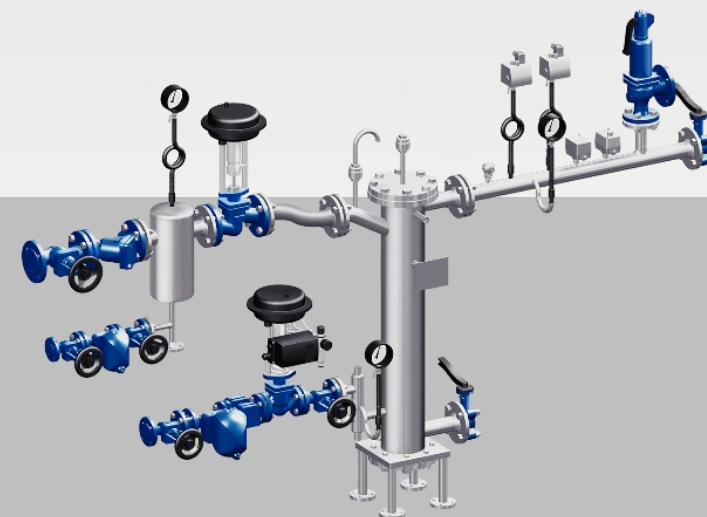

Engineered Systems

PREsys®
 ENCOsys®
 CORsys®



Many products also available in ANSI

Control



STEVI® Pro
High-performance control valve



STEVI® Vario
Variable, compact control valve



STEVI® Smart
Universal control valve

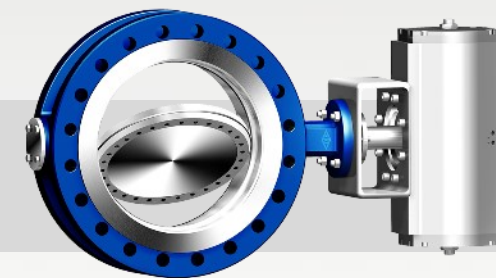

ZETRIX®
Process valve

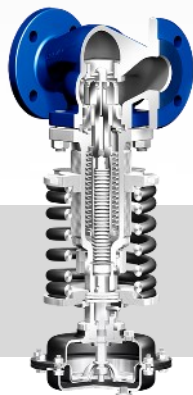

PREDU®
Pressure reducing valves



TEMPTROL®
Temperature regulating valves

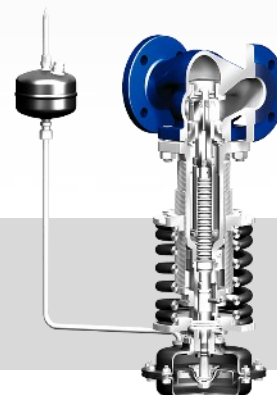

PREDEX®
Excess pressure regulating valves

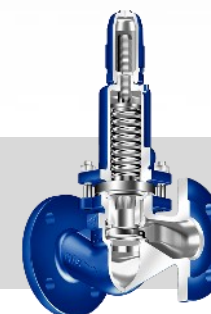

PRESO®
Pressure regulating valves

Isolation



FABA®-Plus / -Supra
Bellows seal stop valves



ZETRIX® Process Valves
ZEDOX® High Performance-Valves



ZESA® / GESA®
Butterfly valves



EURO-WEDI®
Soft sealing globe valves



ASTRA® / -Plus
Combined flow regul. valves

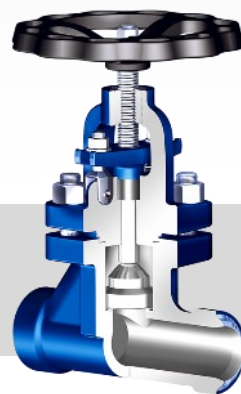

STOBU®
Gland seal stop valves

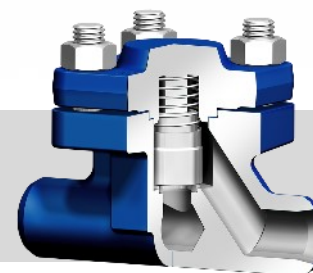

CHECKO®-D / V
Check valves

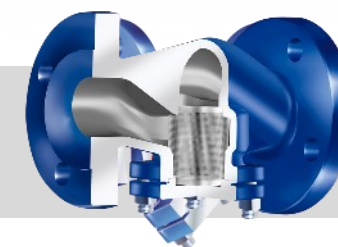

Strainer

Safety

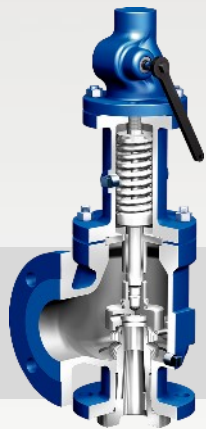

REYCO® R
ASME VIII, API526 Full Nozzle

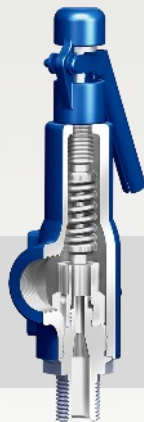

REYCO® RL14
ASME VIII, Threaded



REYCO® RL40
ASME VIII, Threaded



SAFE-SN
ASME VIII, Semi Nozzle



SAFE
Full-lift safety valves (DIN)

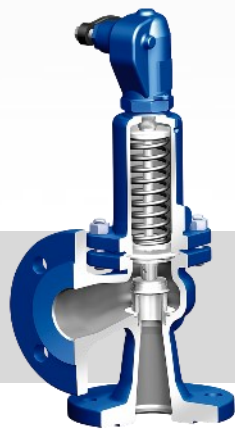

SAFE-P
Standard safety valve



SAFE-TC
Threaded



SAFE-TCP/TCS
For high pressure up to PN 100

Steam Trapping

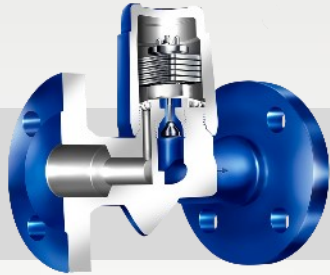

CONA®-B
Bimetallic

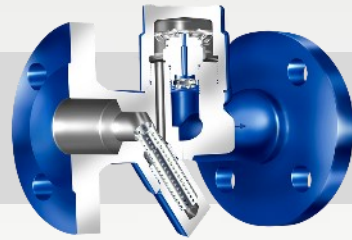

CONA®-M
Thermostatic

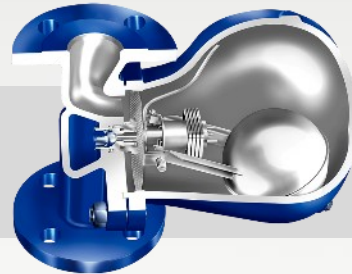

CONA-S
Ball float

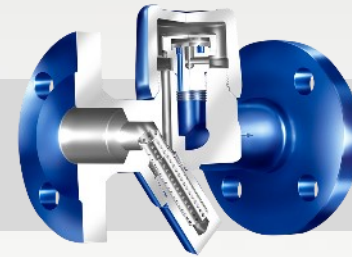

CONA®-TD
Thermodynamic

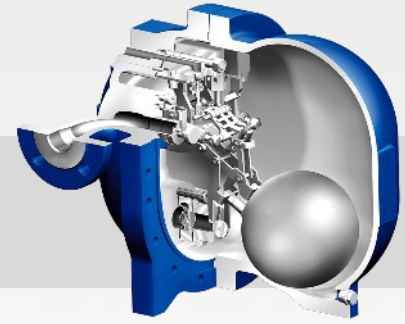

CONA®-P
Pump trap

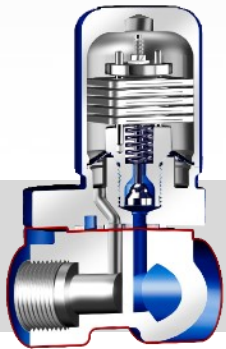

CONA® Universal
Steam trap with flanges



CODI®
Manifolds



CONA®-Control
Monitoring system



CONA®-All-in-one
Bimetallic steam trap



CONLIFT
Float operated
condensate pump

Engineered Systems

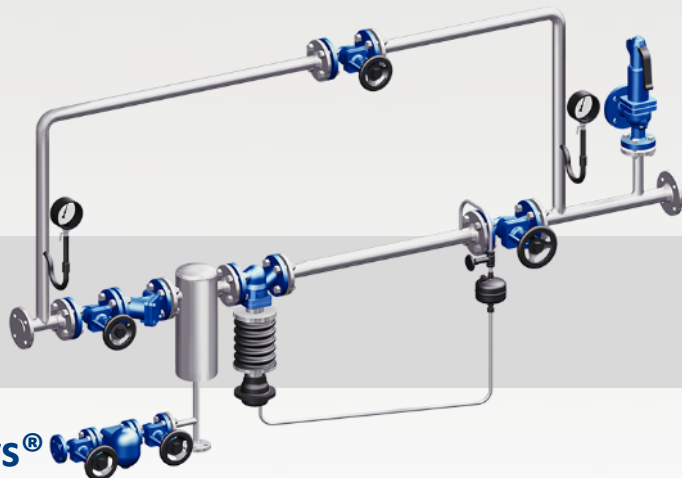

PREsys®
Pressure reducing system



CORsys®
Condensate return system

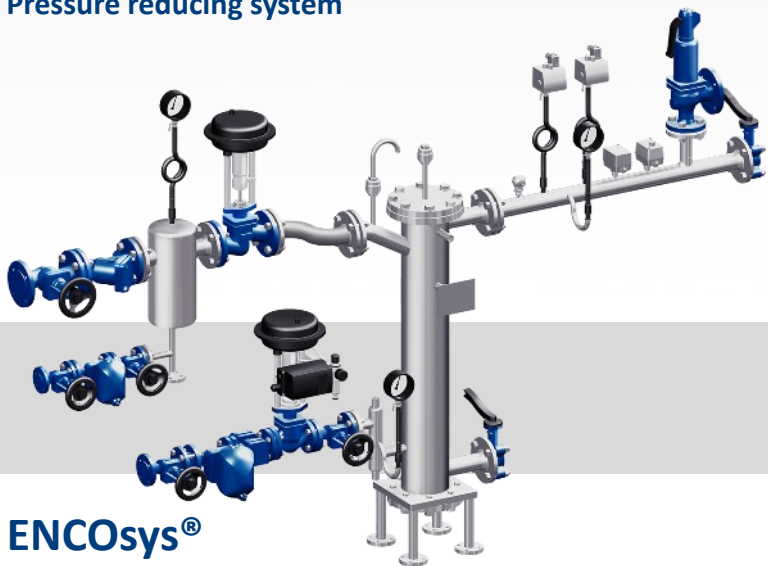

ENCOsys®
Heat exchanger system

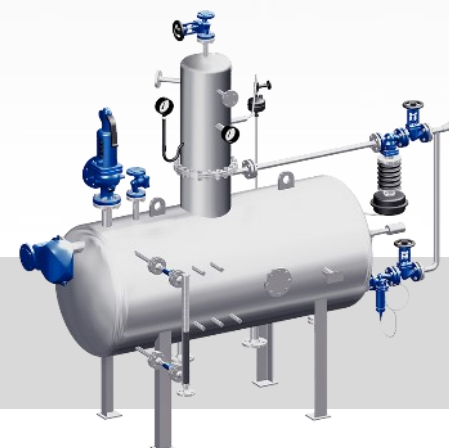

Feedwater Tank
with deaerator dome

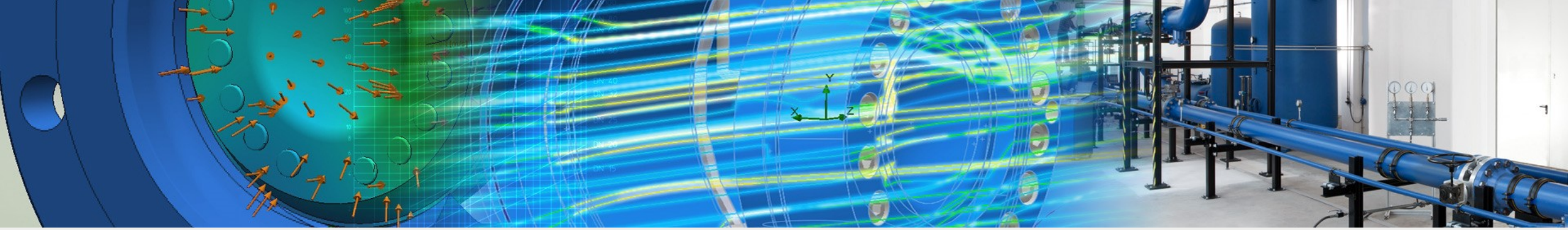

Experience and Know-How – the Search for New Ideas!

- ▶ 5 design teams
- ▶ 1 lab team
- ▶ 1 system support team
- ▶ FEM stress analysis
- ▶ Flow simulations
- ▶ Extensive in-house test facilities



Speed, Quality and Reliability – a Sound Basis for Strong Partnerships

- ▶ Three manufacturing locations in Germany
- ▶ Product oriented fractal manufacturing system
- ▶ Regular investments in state-of-the-art production technologies
- ▶ Central logistics centre with more than 15000 storage bins
- ▶ Fully integrated ERP, CAM and CAQ systems
- ▶ Implemented continuous improvement processes (CIP)



Your Satisfaction – Added Safety Through Certified Quality

- ▶ Incoming goods inspection
- ▶ Final acceptance
- ▶ Certificate management
- ▶ Customer service
- ▶ Inspection, measuring and test equipment management
- ▶ CAQ system
- ▶ Certifications to DIN 9001, Lloyd's, German Lloyd, Det Norske Veritas
- ▶ Environmental and energy management according to DIN ISO 14001 und DIN ISO 50001



Training as the Foundation for our Future Success

- ▶ More than 60 trainees in industrial, technical, commercial and IT professions
- ▶ Internal professional development programs
- ▶ Manual training in our modern workshops
- ▶ Master and Bachelor, Practical study programs, entry opportunities for university graduates, students writing their thesis,
- ▶ Working and placement students



Our Vision for the Future

- ▶ We strive to achieve the highest possible quality.
- ▶ We are masters in our own house – and we intend to keep it that way.
- ▶ Through our one-stop shop philosophy we will continue to do everything in our power to maximise your satisfaction in the framework of strong partnerships.
- ▶ For us at ARI "Made in Germany" is both an obligation and an incentive.





Your One-Stop-Shop for Control, Isolation, Safety, Steam Trapping and Engineered Systems

Don't hesitate to ask for advice.
We'd be delighted to help you
in any way we can!

- ▶ www.ari-armaturen.com
- ▶ info.sales@ari-armaturen.com
- ▶ +49 5207 994-0