

SELBY RUFC

20TH OCTOBER 2018 - YORKSHIRE 1

www.selbyruffc.club



A very warm welcome to
our Vice Presidents and
Honorary Life Members

The Swan

Selby's Official Match Day Programme

Welcome to Middlesbrough RUFC
for Today's Game



Middlesbrough Rugby Club

Limited Numbers Remain



200 Club

Monthly Prize Draw

£30 : £20 : £10

Main Prize Draw

£500 : £250 : £150 : £100

drawn at The President's Dinner

Annual Subscription £20

Paid annually or by monthly direct debit

For payments at the Bar quote 200 Club and your name

For further details contact:

Chris Guthrie : Email secretary@selbyrufc.com

Limited Numbers Remain

Good afternoon and welcome to Sandhill Lane for our fourth home fixture of the season against high-flying Middlesbrough, a match which I understand may carry the double significance of also being a Yorkshire Shield First Round Match. I would also like to extend a special welcome in particular to those Club stalwarts who will be enjoying a pre-match lunch and who have received the accolade of Vice President or Honorary Life Member. The Club owes each and every one of them a debt of gratitude for many years service, which have helped create a ground and facilities that are the envy of many many people who are lucky enough to pay us a visit.

A look at the current League table shows that Middlesbrough currently sit in second place whilst we have improved our own position with a couple of hard earned and very valuable wins. Middlesbrough played their latest fixture against Guisborough on a Friday night and I will be very interested to hear the reasons for that being the case and of course to find out whether the evening was a success and something we could look at for future League matches, particularly at the time of the 6 Nations when player availability can sometimes provide us with a selection headache. Middlesbrough enjoyed a comfortable victory in their local derby so will no doubt consider it all worthwhile. I think most people would have been somewhat surprised by Middlesbrough's previous heavy loss at Crossleyans, given their previous results, and I am certain that our visitors today will be keen to show that it was just a blip in their own quest for promotion.

Last weekend saw us again totally dominate the Scrum against Keighley, however all other areas of the game were closely fought and ensured another tense match but ultimately a thoroughly deserved victory. Amongst the disappointments were the concussion injuries to Skipper Charlie Cicero and Harry Cruise with barely a quarter of the game gone, but the resilience and sense of togetherness amongst the squad will no doubt stand the players in good stead for the difficult fixtures to come. Best wishes for a speedy recovery go to Charlie and Harry and of course any of our players currently recovering from injury.

It is really good to see that we have been able to continue to turn out 4 sides even though the 4th team fixture against Old Modernians had to be cancelled due to lack of opposition. The thirds were even able to travel to Ribblesdale with 3 subs, which is another very positive indication of the work being put in to ensure as many people as possible are able to turn out on a Saturday. My congratulations and thanks go to Captains, Managers and players involved in all of our lower sides. It was really interesting to read in Keighley's programme last weekend that the RFU are again looking at the composition of Leagues in the Northern Division and having to consider the possibility of combining some of the teams in farthest West Yorkshire with teams from the Eastern fringes of Lancashire. There are a number of important meetings taking place in the next couple of months and the views represented at them will no doubt help to shape the future of Leagues throughout the North.

Following on from our pre-match lunch today we intend to hold a couple of pre match Members' Lunches before Christmas to gauge their popularity. I am sure that details about them and how to book a place on a table will appear in the match day programme and on the Club's Pitchero website very soon.

Finally a gentle reminder to everybody taking part in or spectating this afternoon's game to please show respect to the match officials, players from both sides and other spectators. There is nothing better than a hard fought game of Rugby played out in front of a knowledgeable and friendly crowd and we all have to play our part in ensuring that everybody here this afternoon can go home afterwards having enjoyed some great entertainment, whether a player, flag man, referee, water boy, allickadoo or a member of the paying public. We have a duty to all visitors to Sandhill to ensure that their afternoon is not ruined by the actions of one or two individuals and that everybody adheres to the RFU Code of Conduct, so I would ask that everybody makes sure that they behave in a manner befitting our great game.



SELBY RUFC SPORTING DINNER

Thursday 16th May

Guest Speaker

MATT DAWSON

Master of Ceremonies

JOHN INVERDALE

Packages

STANDARD
£500

includes food & evening entertainment

VIP £1300

includes champagne reception,
food, drinks & evening
entertainment

BOOK NOW – COMMS@SELBYRUF.COM

HELP US SPREAD THE WORD
CLUB FUNDRAISER

Selby RUFC, Sandhill Lane, Selby, YO8 4JP
Telephone: 01757 703608



Special thanks to sponsors



A Grundy
Financial Director



SELBY RUFC

SUMMER BALL

Last Few Tables Remaining

Saturday 18th May

FEATURING LIVE MUSIC FROM

the nightjars

Packages

RED
£65^{pp}

includes welcome drink
& food

GREEN
£75^{pp}

includes red package plus half
a bottle of wine per person

GOLD
£85^{pp}

includes green package
plus VIP drinks reception, 2
glasses of fizz and best seats
in the house

BOOK NOW – COMMS@SELBYRUF.COM

 HELP US SPREAD THE WORD

Selby RUFC, Sandhill Lane, Selby, YO8 4JP
Telephone: 01757 703608



Taperell Group

S.J. & J. M. Taperell

Taperell Environmental

Skip Hire

Aggregate Recycling

Suppliers of Stone & Top Soil

Tel: 01757 270 191



Marcus Taperell
Tree Surgery
Tel: 01757 270 214



MAYFAIR
FIRE & SECURITY

Protecting the Community Since 1986

PROUD TO SPONSOR SELBY RUFC



**Intruder
Alarms**



**CCTV
Systems**

**Care
In The
Community**



**Fire
Alarms**

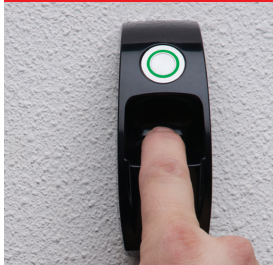

**Access &
Door Entry
Specialists**



**SIA Licensed
Guarding
Services**

01757 701596

www.mayfairsecurity.co.uk



Mayfair Fire & Security is a trading names for Careline Security Ltd.

THE LAST TIME WE MET | Selby RUFC 32 v 49 Middlesbrough RUFC

Report by Ian Marlow

Selby returned to league rugby with another defeat against Middlesbrough that keeps them rooted to the foot of the table but in scoring six tries of their own the Swans provided further evidence of a turnaround in their performances that gives some hopes for the future.

Selby's forward dominance, particularly in the scrum, continued from last week but also continuing was their inability to turn pressure into points. And as so often has happened this season, the disappointment of a missed Selby penalty kick was compounded by a try from Middlesbrough who were confident throwing the ball around all afternoon. Selby's pressure did then lead to an unconverted try for Danny Wilkinson playing assuredly at scrum half before Middlesbrough cut loose again with poor Selby tackling allowing two further tries to move well ahead on the scoreboard.

It was to Selby's credit that these setbacks did not lead to any collapse in confidence or performance, as has been witnessed before this season, but instead seemed to act as a catalyst for renewed effort which showed the recent improvement in resilience of this young team. Firstly winger Harry Cruise squeezed into the corner for another unconverted try before Selby's forward domination finally paid off with a line out catch from Jack Hebdon, who was excellent all match, giving the big boys the chance to trundle over with Ben Booth providing the coup de grace.

With the half coming to a close and the scores still tight Selby then showed their inexperience and weakness as from a position of control they disappointingly lost possession to allow Middlesbrough to score again to take the wind from Selby's sails at half time.

Any chance of Selby regaining their momentum after half time was negated as yet another bugbear of the season resurfaced as they shot themselves in the foot with another silly yellow card. Middlesbrough duly took advantage with a catch and drive try before Selby returned the favour with one of their own – Ben Booth again being the man in possession as the ball was dotted down. The next twenty minutes belonged to Middlesbrough as they continued with their assured handling to score two more tries but, again, Selby were not for cracking and came back to earn their own Middlesbrough yellow card after sustained pressure on the opposition line. It was Selby's chance to take advantage of the extra man and indeed they did with two further tries from Liam Hogan and, to complete his hat trick, Ben Booth again taking advantage of the work of his fellow forwards to grab the glory with an injury time try.

While the final scoreline of 32-49 indicates a relatively conclusive loss the try count of 6-7 against gives a better indication, not just that Middlesbrough converted most of their kicks at goal while Selby did not, but that the teams were much more closely matched than the scoreline suggests. Given that Middlesbrough are a good top of the table side this should give cause for optimism that Selby can, with a little bit more experience and composure and the return of some key players, still turn the season around and start to move up the table.

Next Saturday Selby are playing away with an interesting first league fixture against Old Rishworthians who were promoted last season - and while the Old Boys will be an unknown quantity the Swans will be hoping to build on recent promise with a win.



SOCIALS @ THE CLUBHOUSE - ACTION REQUIRED!!

Friday 2nd November

GIN & Fizz

Featuring 2 guest gins!

£12 per person includes:
Two free drinks
Nibbles
Entertainment

Reserve your space with Wendy as numbers are limited.



Selby RUFC - Ladies Christmas Lunch

Saturday 1st December at 11.45 for 12.15 pm lunch

1st Team Home against Old Rishworthians with KO at 2.15 pm

Tickets £15.00 pp
Tickets from Andrea at andrea23phillips@hotmail.com



WAREHOUSE FACILITIES INCLUDE:

- FULL ORDER RECONCILIATION
- STOCK CONTROL
- ORDER PICKING
- DISTRIBUTING ALL OVER THE WORLD
- INDOOR LOADING / UNLOADING
- QUICK VEHICLE TURNAROUND
- HANDBALL FACILITIES

FOR FURTHER INFORMATION MAIL TO:

anthony@humbermaritime.com or orders@humbermaritime.com

Or Call: 01405 764365

PROUD SPONSORS OF : RUPERT AND QUINTIN McGRORY-HILL

HAVE A GREAT SEASON LADS !





Horbury Group

The Horbury Group provides a complete national service to the construction industry, which includes:

- Drying and Partitioning
- Joinery
- Suspended Ceilings
- Carpets, Vinyl and Timber Flooring
- SFS
- External Facades and Cladding
- Full Fit-Out
- Refurbishment and Maintenance
- Demountable Glazed Screens
- Decoration
- Structural Fire Protection
- External Wall Insulation

Contact us - telephone: 01709 515044 or email: enquiries@horburygroup.com



Building homes of the future today.

Adina are not your usual house developer. It is our belief that family homes should give families the space to live and grow. We ensure that all of our homes are built on larger than average plots, so the inside and outside space is not just practical but enjoyable. Our mission is to build sustainable and energy efficient future proofed homes.



[@adinadev ltd](https://twitter.com/adinadev ltd)

www.adinadev ltd.com

R&N

Landscape Services

Your local landscape service specialising in

PATIO DESIGN & CONSTRUCTION
DRIVEWAY DESIGN & CONSTRUCTION
DECKING & PERGOLAS
WATER FEATURES AND PONDS
FENCING CONSTRUCTION
GARDEN & RETAINING WALLS
TURFING & SEEDING
TREE SURGERY & HEDGE CUTTING
LOW MAINTENANCE GARDENS
GARDEN CLEARANCES

Fully Qualified & Insured

Laburnum Farm, Wistow Lordship, Selby, YO8 3RR

Rich Sherwood - 07879 626838

Office - 01757 702852

Beautiful gites in rural South West France



Four properties of various sizes
Each with own terrace area and BBQ overlooking the valley
Short drive from Carcassonne and situated in the Cathar Country

Search www.homeaway.co.uk for the following holiday property references

3407333 Sleeps 4

3407334 Sleeps 12

3407335 Sleeps 4

3407336 Sleeps 4

Contact Amy or Wright Phillips for details on:
01977 681976 or france@waingap.co.uk





CODE OF RUGBY

Everyone involved in rugby in England, whether as a player, coach, referee, administrator, parent or spectator is expected to uphold the Core Values of our sport.

Teamwork · Respect · Enjoyment
Discipline · Sportsmanship

- Play to win - but not at all cost.
- Win with dignity, lose with grace.
- Observe the Laws and regulations of the game.
- Respect opponents, referees and all participants.
- Reject cheating, racism, violence and drugs.
- Value volunteers and paid officials alike.
- Enjoy the game.

**THIS IS
RUGBY.**

A. GRUNDY

FUNERAL DIRECTOR

FAMILY OWNED & FAMILY RUN BUSINESS



DAY OR NIGHT SERVICE

PRIVATE CHAPEL OF REST

PRE-PAYMENT PLAN AVAILABLE

THE OLD VICARAGE
145 GOWTHORPE
SELBY, Yo8 4HD
TEL: SELBY 01757 213500

STEVE CRUISE | FROM THE DUG OUT

Well today we entertain the team who I predicted would win the league this season, as you know I only took over the reins here last January and in that time Middlesbrough were the best team I saw by a country mile, I appreciate York and Scarborough got promoted and I did take a lot of criticism on the 'Yorkshire forum' for saying that, but I can only give an honest rugby view and in terms of pure rugby quality the Teesiders were streets apart from anyone else. Their favourite billing doesn't appear to be holding them back this term either as they sit in second place as we speak, their only blemish was a surprising defeat at the hands of Old Crossleyans in Halifax in September. So this is a mouth-watering prospect for our young team as they attempt to stamp their mark on the league this term.

Since my last programme notes we have enjoyed two back to back narrow victories, firstly at home to a much improved Hullensians team (Thanks in no part to an influx from Ionians and Hull) and last week we earned a very creditable 4 point win away on the 4G pitch at Keighley. Our second half performance and our overall defensive effort gave us a worthy victory, its never easy winning away in Yorkshire One and to win at a ground where the home team obviously have an advantage through their knowledge of the surface was very rewarding. Particularly in the second half I thought we gave the opposition a lesson in how to turn possession to point and how to execute when presented with opportunities, something the hosts failed to do in the first 40 minutes.

Last week we suffered from 3 head injuries, two of our players (captain Cic and Harry Cruise collided heads) and are out today through the head injury protocol, Harry may have to take a longer period out of the game because of the number of head knocks he has taken in the last 12 months. We take these things very seriously, rugby is important but so is the welfare of the player and in line with RFU regulations our physio Hayley Brady has a detailed report of every players injuries so she can make considered opinions based on facts. Medical advice drives selection at Selby and I hope it does these days at most clubs, the days of a player saying "I think I'm ok" should be well in the past. On the positive side we should have 4 players who were unavailable last week re-joining the group for today's game.

Yorkshire One this year is proving to be a very competitive league as Hullensians beating Beverley last week is testament to this view, in the early weeks our guests today are chasing Crossleyans for top spot, but the money men at Moortown are pressing hard and last week's defeat might just inspire Beverley to get back on track. As for ourselves we are sat in 9th but maybe 6th or 7th is more of a true reflection of our season to date. One thing is for sure we will surprise teams this year and I hope it starts today.

We have actually drawn our opponents today away from home in the Yorkshire Shield in a few weeks' time and there was a discussion between the two coaches of making todays game a 'double header' with Middlesbrough effectively forgiving home advantage but in the end this hasn't happened for one reason or another, so we will be heading to Acklam on the 10th November.

Our youth system continues to develop players at a pace and I have been pleased to be able to give first team debuts to Olly Turver, Olly Raynor, Edward Kelly and Eddie Brown over the last few weeks all of whom are studying at various locations and only available infrequently. We are working really hard on the transition of our players from colts to adult rugby and a big part of this process is first of all knowing where every boy is, when they are available and also working with Academies and Universities as a partnership for the good of the player so they are able to balance the amount of game time and training within specific laid down guidelines.



Today will see the home debut of Sam Phipps who is fitting into life at Selby very well. Thank you to our president and his wife Diana for providing him with a home and to Adina Developments for providing him with work. Sam is here on a two-year visa and based on his personality and impact so far we very much hope he spends the whole time at Sandhill Lane. As a rugby player I'll let you decide, but all I will say he is a typical Kiwi forward, for those of you that remember Karim Brown, well just add, bigger, more powerful. Welcome Sam and enjoy your home debut



Finally it was very interesting watching last weeks game on the 4G pitch, I'm not so sure where I stand on them, there are certain clubs where there is no doubt there is a major benefit due to their poor playing surface and having spoken to the committee at Keighley last week this was one of their key drivers for sure. I also understand that Yarnbury (thank god everyone says) and Old Brodleians are also investing in one but £700,000 is an awful lot of money. Then from a playing perspective there are arguments on both sides of the scale. On the positives, the game is more expansive, its faster, it quickens up the ruck area, the ball is never really wet or muddy and it definitely changes the team's style of play (just look at Newcastle Falcons three years ago and how they play now). Then on the downside I had players with really bad burns on their knees and legs, the ball can bounce in different directions to what it does on grass, it can actually provide backspin and at scrum time if you are dominant and get a team moving backwards their studs don't slide in the grass and they have more time to repurchase their footing. Anyway, you will all have an opinion but one thing is for sure its grass at Sandhill Lane and with such a beautiful playing surface why should we change, I bet Middlesbrough are considering one though!!!!

Enjoy the game today, I'm two points behind on my little purple book and could do with them back

Yours in rugby, Steve Cruise

OUR FUTURE IS BRIGHT (JUST A BIT SOGGY HERE!).....



JOIN THE GALLOP

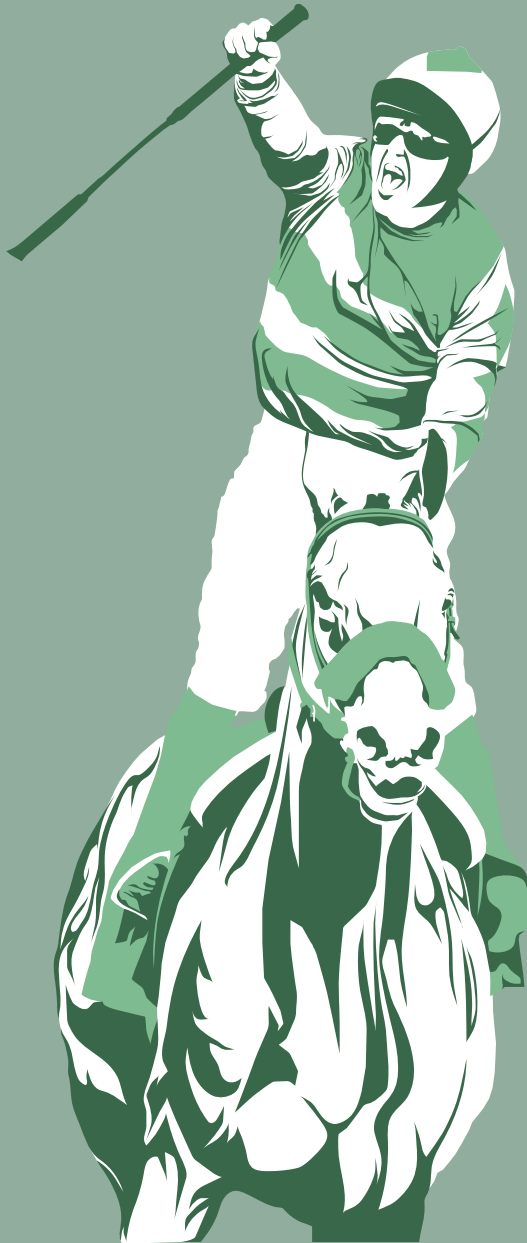

www.gallopracing.com

#jointhegallop

 [gallopracing](https://www.instagram.com/gallopracing)  [gallop_racing](https://twitter.com/gallop_racing)

Working with growers for 80 years



Hutchinsons remains a **family business** offering **specialist agronomy advice, services** and inputs nationwide, together with **agricultural & amenity supply**.

Hutchinsons can provide you with all your crop-growing, agricultural and amenity requirements including, advice, agrochemicals, mobile seed dressing, laboratory services, fertiliser, grass seed, loam, top dressing, mulches, micro-nutrients and pesticides.

Our professionalism is matched by our total commitment to customer service.

It's our people that make the difference

HUTCHINSONS Crop Production Specialists

H L Hutchinson Limited
Market Weighton Road • Barby • Selby
North Yorkshire • YO8 5LD

Tel: 01757 289191

Fax: 01757 288395

www.hlhtd.co.uk



Omnia
Precision Agronomy



HEALTHY SOILS



READ SCHOOL
DRAX

Pre-Reception

Early Years Department

- Tranquil, rural environment
- Pre-Reception class promotes 'school readiness' with a structured learning programme
- Lessons (8:30 - 5:00 pm) taught by qualified teacher
- Specialist teachers teach languages and PE lesson
- Large, natural outdoor play area provides enriched learning experience
- Full range of educational visits



The best possible start

To register please contact: headspa@readschool.co.uk or call 01757 618248

www.readschool.co.uk

Founded 1667



H.F. BROWN & SON LTD

Portland Works, Main Street,
Hemingbrough, Selby,
North Yorkshire, YO8 6QF

*Quality & Service
since 1947*

01757 638262

www.hfbheating.com



**PLUMBING, HEATING &
MECHANICAL CONTRACTORS**

Burn Fencing Ltd

Tel: 01302 708706 Fax: 01302 707377

Webiste: www.burnfencing.co.uk Email: enquiries@burnfencing.co.uk

Keeping stock in, and intruders out.

Complete fencing solutions include:

- Acoustic fencing
- Agricultural fencing
- Automated gates and Barriers
- Barriers and Bollards
- Highways
- Railways
- Security fencing and systems
- Social fencing
- Sports fencing
- Temporary Hoarding



West End Farm, West End, Balne, Goole, East Riding DN14 0EH

**LET ME TACKLE YOUR
ELECTRICAL PROBLEMS**



S. B. COOK

ELECTRICAL CONTRACTOR

*DOMESTIC, COMMERCIAL & INDUSTRIAL
ELECTRICAL INSTALLATION & MAINTENANCE*

NO JOB TOO SMALL
WHY NOT GIVE ME A TRY AND ASK FOR A QUOTATION

TELEPHONE: 01757 706737

***R. LOWERY ROOFING CONTRACTOR
LIMITED***

SLATING - TILING - LEAD WORK - FLAT ROOFING

ESTABLISHED 1989

BEECH COTTAGE, STOCKHILL COURT, SELBY ROAD, CAMBLESFORTH, SELBY,

NORTH YORKSHIRE, YO8 8HR

TEL/FAX 01757 618666 MOBILE 07801 494071

**Liam Hogan
Sponsored by
Eliments**

**Rupert McGrory-Hill
Sponsored by
Humber Maritime
Services**

**Andy Keogh
Sponsored by
The Muffits**

**Andy Mccloughlin
Sponsored by
Powerwash
Yorkshire Ltd**

**Sam Phipps
Sponsored by
Peter Bramley**



**James Dentith
Sponsored by
Baltic Training
Services Ltd**

**George Stoker
Sponsored by
Chris Guthrie &
Y Ddraig Cymru**

**Tom Edwards
Sponsored by
ICS Tree Services**

**Quintin McGrory-Hill
Sponsored by
Humber Maritime
Services**

**Alex Webster
DHL**

SELBY RUFC

15 G Stoker
14 A Dallimore
13 A Webster
12 G Gorman
11 M Leetham
10 O Turvey
9 D Wilkinson (c)

1 D Hardy
2 M McCoy
3 A Tunningley
4 M Wood
5 S Clarke
6 S Phipps
7 T Edwards
8 L Hogan

16 J Dentith
17 S Broughton
18 J Robinson

**WELCOME
TO ALL OUR
SPONSORS**

Matthew Wood
Sponsored by
William Bayston

Gary Brown
Sponsored by
Rainbow IT

Duncan Hardy
Sponsored by
Peter Foster

Millar McCoy
Sponsored by
Sage Arts & Crafts

Middlesbrough RUFC

**WE HOPE
YOU ENJOY
THE DAY**

M Todd 15
R Kilbride 14
J McPhillips 13
(c) P Homan 12
B Hill 11
A Baggett 10
C Foley 9

S Taylor 1
S Hoare 2
K Clark 3
R Lonsdale 4
M Colvin 5
J Pearce 6
R Brown 7
L Wilson 8

M Helm 16
S Jarvis 17
A Micklewright 18



Andy Gorman
Sponsored by
The Muffits

Ash Dallimore
Sponsored by
Dallimore Family

Adam Leetham
Sponsored by
Stephen Ward

Matthew Leetham
Sponsored by
Nomenca

THORPE CARS

07733 421494

**PRIVATE HIRE
FAST, FRIENDLY
RELIABLE SERVICE**

8 SEATER



CARS

APPEARANCES THIS SEASON

	Name	App	Sub	NU	T
1	Cicero Charlie	7			7
2	Leatham Matthew	7			7
3	Dallimore Ashton	6			6
4	Hardy Duncan	6			6
5	Hogan Liam	6			6
6	Wilkinson Danny	6			6
7	Edwards Tom	5	1		6
8	Stoker George	5			5
9	Clark Stephen	4	1		5
10	Leatham Adam	4	1		5
11	Raddings Joseph	4	1		5
12	Webster Alex	4	1	1	5
13	Cruise Harry	4			4
14	Hebden Jack	4			4
15	Kehoe Andrew	4			4
16	McCoy Millar	4			4
17	Broughton Sam	3	2		5
18	Gorman Andy	3			3
19	Ibbetson James	3			3
20	Robinson James	3			3
21	Tunningley Andrew	2	4	1	6
22	Parkinson Ashley	2	1		3
23	Kelly Edward	2			2
24	Dentith James	1	2		3
25	Turvey Oliver	1	1		2
26	Brown Edward	1			1
27	McLoughlin Andrew	1			1
28	Phipps Sam	1			1
29	Raynor Oliver	1			1
30	Wood Matthew	1			1
31	McGrory-Hill Quintin		2		2
32	Booth Joshua		1		1
33	Grace Alex		1		1
34	Rowntree Paddy		1		1
35	Thompson Charles		1		1

Half-Time Conundrum

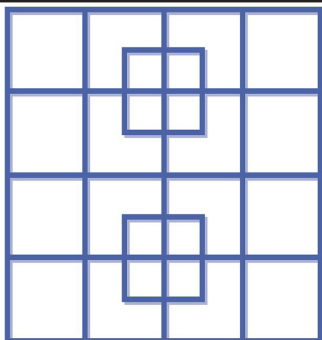

How many squares are
in the picture?

TOP POINT SCORERS

NAME	Tr	Cnv	Pen	Drp	T
Dallimore Ashton	5				25
Webster Alex	2	3	1		19
Clark Stephen	2				10
Broughton Sam	2				10
Hogan Liam	2				10
Cicero Charlie	1				5
Leatham Matthew	1				5
McCoy Millar	1				5
Stoker George		1	1		5
Wilkinson Danny	1				5
Cruise Harry		2			4

TEAM TRIES

MOORTOWN	34
MIDDLESBROUGH	28
BEVERLEY	24
OLD CROSSLEYANS	24
OLD BRODLEIANS	23
PONTEFRACT	22
HEATH	21
BRADFORD SALEM	18
HULLENSIANS	17
OLD RISHWORTHIANS	17
DINNINGTON	16
GUISBOROUGH	16
SELBY	15
KEIGHLEY	11

TEAM TRIES CONCEDED

MIDDLESBROUGH	12
HEATH	13
OLD CROSSLEYANS	13
BRADFORD SALEM	14
OLD BRODLEIANS	16
SELBY	16
MOORTOWN	18
PONTEFRACT	19
BEVERLEY	23
GUISBOROUGH	23
OLD RISHWORTHIANS	25
KEIGHLEY	29
HULLENSIANS	31
DINNINGTON	34





Low-level fibreglass platforms

- PAS250 compliant
- Non-conductive (100kv/ft)
- Chemical resistant
- Weather resistant
- Spark resistant
- Visible colour
- Non-slip platform deck
- Non-slip step treads
- Anti-slip feet
- Captive ladder
- Locking gate
- In-line castors

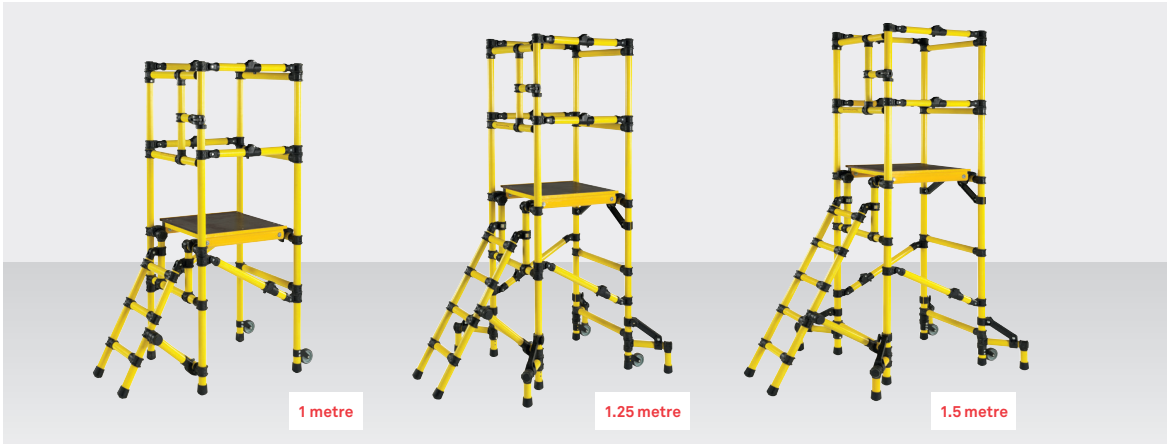

The **Protec Podium** brings you all the advantages of a fibreglass access solution, non-conductive up to 100 kilovolts per foot, in the shape of a compact tower.



Design | Build | Inspect | Maintain

0800 0854 161

info@planetplatforms.co.uk
planetplatforms.co.uk



Certificate Number 12882
ISO 9001 - 2015



0513



INVESTORS
IN PEOPLE

Planet Platforms Ltd. Brunel Close, Century Park,
Wakefield 41 Industrial Estate, Wakefield, WF2 0XG.



MILD STEEL SHEET, PLATE AND SECTION STOCKIST

- HOT ROLLED SHEETS - UPTO 20mm THICK
- TEAR PATTERN SHEET (NON SLIP FLOOR PLATE)
- FLAT GALVANISED SHEET - FULL RANGE OF SIZES
- RSJ'S - CUT TO LENGTH AND PRIMED
- BOX SECTION - ANGLES - FLATS
- EXTENSIVE STOCKS
- DELIVERED ON OUR TRANSPORT

**FOR A PROMPT, FRIENDLY, RELIABLE
SERVICE PLEASE RING:**

TEL: 01904 608773 / FAX: 01904 608754

AIRFIELD BUSINESS PARK, ELVINGTON, YORK, YO41 4AU



WRPS

MATERIAL RECYCLING & WASTE MANAGEMENT

West Riding Paper Service Ltd are a one stop shop for all your waste and recycling requirements, we have a proud heritage founded on service, built up over many years in the industry. We aim for zero to landfill, supporting green initiatives for SMB's to blue-chip organisations and local authorities.

Material Recycling & Waste Management Specialists

Engineering Services

Waste Audits

Local paper and cardboard recycling collection services for all needs

Secure confidential paper and product destruction

Archive clearance service

West Riding Paper Services Ltd aim for zero to landfill

Over 85 years combined experience in recycling

South Barn, Brecks Farm, Selby Road
Monk Fryston LS25 5EL

Tel/Fax: 01977 689046

Email: clive.hoyland@westridingpaperservices.co.uk

Website: www.westridingpaperservices.co.uk

Sweet Dreams are Made of Cheese



Celebrate with a 'Chucks n Cheese' Tower
Call Zoe for more details 07552 167070

Chucks n Cheese, St. Laurence House, Long Lane, Pollington, Goole DN14 0DF



We are proud to sponsor
 Matthew Leetham
 Selby RUFC
www.northmid.co.uk



PEOPLE INSPIRE EXCELLENCE

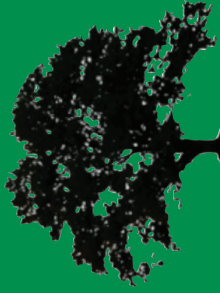

ICS TREE SERVICES LTD

Tree Surgeons & Landscape Contractors
 01132 320495 / 07782 251881

- ✓ All Aspects of Tree Surgery Undertaken
- ✓ Stump Grinding
- ✓ Domestic / Commercial Site Clearance
- ✓ Supplier of Quality Logs & Wood Chip
- ✓ 24hr Emergency Call Out
- ✓ Specialists in Large & Dangerous Tree Removal
- ✓ Hedges Cut / Removed / Shaped
- ✓ Fencing & Turfing
- ✓ General Landscaping & Commercial Grounds Maintenance
- ✓ Fully Qualified & Insured

www.ic-s.org.uk / ian@ic-s.org.uk



FREE NO OBLIGATION QUOTE AVAILABLE



elmhirstparker

SOLICITORS & ESTATE AGENTS

are pleased to be
associated with

SELBY
R.U.F.C

SELBY

01757 703602 - 703895

SHERBURN

01977 682219

selby@elmhirstparker.com

sherburn@elmhirstparker.com

www.elmhirstparker.com



Laura Hindle,
Director

Experts in tailored insurance solutions

Our dedicated team of insurance specialists have been advising clients for over 40 years. We offer a wide range of experience and knowledge, allowing our clients the comfort that all their insurance needs are provided for.

We work with a varied range of organisations within the commercial and charity sectors, contact us today to find out how we can assist your organisation.

Tel: 01904 784141



@DEFordInsurance



defordinsurance



www.deford.co.uk

D E FORD Ltd, Poppleton Grange, Low Poppleton Lane, York YO26 6GZ

D E Ford Insurance Brokers Ltd is authorised and regulated by the Financial Conduct Authority Firm Ref No. 308563 www.fca.org.uk



The UK's leading
animal feed supplier

**Compound Feeds • Blends
Straights • Moist feeds
Forage products • Silage additives**

For more information about ForFarmers
visit our website: www.forfarmers.co.uk





Yorkshire 1 - 1st XV Fixtures

SEPTEMBER

- H Sat 01 Hullensians
- A Sat 08 Heath
- H Sat 15 Bradford Salem
- A Sat 22 Dinnington
- H Sat 29 Old Crossleyans

OCTOBER

- H Sat 6 Hullensians (R)
- A Sat 13 Keighley
- H Sat 20 Middlesbrough
- H Sat 27 Guisborough

NOVEMBER

- A Sat 03 Old Brodleians
- H Sat 17 Moortown
- A Sat 24 Pontefract

DECEMBER

- H Sat 01 Old Rishworthians
- A Sat 08 Beverley
- H Sat 15 Heath

JANUARY 2019

- A Sat 05 Bradford Salem
- H Sat 12 Dinnington
- A Sat 19 Old Crossleyans
- H Sat 26 Keighley

FEBRUARY

- A Sat 09 Middlesbrough
- A Sat 16 Guisborough

MARCH

- H Sat 02 Old Brodleians
- A Sat 09 Moortown
- H Sat 23 Pontefract
- A Sat 30 Old Rishworthians

APRIL

- H Sat 06 Beverley
- A Sat 13 Hullensians

Yorkshire 1 Results

SATURDAY 6 OCTOBER 2018

Selby 17 • **14 Hullensians**

FRIDAY 12 OCTOBER 2018

Middlesbrough 24 • 3 Guisborough

SATURDAY 13 OCTOBER 2018

Bradford Salem 24 • 17 Pontefract

Dinnington 12 • 60 Moortown

Heath 34 • 7 Old Rishworthians

Hullensians 29 • 5 Beverley

Keighley 14 • **20 Selby**

Old Crossleyans 18 • 13 Old Brodleians

Current Table

TEAM	P	W	D	L	F	A	Diff	Bpts	Pts
Old Crossleyans	6	6	0	0	178	96	82	4	28
Middlesbrough	6	5	0	1	187	92	95	4	24
Moortown	6	4	0	2	233	121	112	5	21
Beverley	6	4	0	2	153	141	12	5	21
Pontefract	6	4	0	2	159	136	23	4	20
Heath	6	4	0	2	154	112	42	3	19
Bradford Salem	6	3	0	3	164	114	50	5	17
Old Brodleians	6	3	0	3	152	137	15	4	16
SELBY	6	3	0	3	91	118	-27	1	13
Old Rishworthians	6	2	0	4	121	164	-43	1	9
Dinnington	6	2	0	4	107	211	-104	1	9
Hullensians	6	1	0	5	110	184	-74	3	7
Guisborough	6	0	0	6	101	169	-68	7	7
Keighley	6	1	0	5	85	200	-115	2	6

JUNIOR RUGBY REPORTS

NATIONAL GIRLS U15 CLUB CUP Round 1 - Scarborough RUFC 10 - Selby RUFC 42

Sunday afternoon, Selby faced a very determined Scarborough side and an endless down pour of rain in their first group match of the Yorkshire Cup. The handling would have been impressive on a dry spring day let alone in extremely wet cold and windy conditions.

A new look Selby starting 15 battled hard and eventually broke the defence down with a well deserved try from the coaches player of the match Dani Moore. Selby soon found their form after a few questionable decisions, growing in confidence the team then took control of the game with fantastic individual tries from Amelie Chandler, Isla Ramsay and try of the game from Lauren Noble, who broke the defensive line with a superb angled run, before going over under the sticks, Eva Abbott converting.

Scarborough hit back with 2 well deserved tries before Selby took the game out of reach with further tries from Sarah Ridley, Eva Abbott, Abi Moore and topped off with full back Agi Hornostaj completing the score.



Selby's captain for the day was Abi Moore, who put in massive shift in the forward line and was relentless both in attack and defence, topped off with superb try. Great support from parents and family members and a shout out to the girls who weren't selected who also made the journey to support their team mates.

Selby Senior Colts 17 -v- Mansfield Colts 12

In very wet conditions which can't have pleased any players or supporters, Selby travelled to Mansfield for what promised to be a tight encounter based on recent results for both teams. The constant rain meant that maintaining possession of the ball was going to be the key to dominance, and both sides struggled to do this in the early stages.

Selby were the first on the scoreboard though, with a terrific try created by the forwards recycling well, and a great burst of speed from the 22 once the ball came out, allowing Owain Sudron to go over, followed by a solid conversion from Henry Bayston. 0-7. Bayston then followed this up with a fantastic penalty from only 10m short of the halfway line. 0-10. Mansfield then started to dominate possession, and for a while, territory. Selby needed to call on all their defensive capabilities to deny the home side the chance of scoring themselves. They were unable to capitalise, and Selby won enough of the ball to frustrate their hard-working opponents. The away team also kicked more sensibly on the whole, putting pressure on Mansfield's full back and wings. However, on the stroke of half time the home team finally strung together enough good play to go over in the left corner for a deserved 5 points. 5-10.

The first 10 minutes of the second half were at a raised intensity, with both sides creating half chances through good possession and phases, but neither side were ultimately able to convert, with the ball being fumbled at the critical moment. Selby's forwards continued to grind, and maintained the upper hand for just long enough within sight of Mansfield's line for Tom Fletcher to power over and extend the lead to 5-17. What had been a very good-natured contest up to that point nearly turned less attractive, as the desire to win got the better of the home team for a 5-minute period, and the referee had to intervene to calm things down. Mansfield stepped up their efforts for a big last push, and relentless pressure on Selby's defences resulted in a converted try for the home side. 12-17. The final five minutes saw more of the same, but Selby's defence stayed strong enough to see them through to a very hard-fought victory.



Joanne & Andy welcome you to the
WHEATSHEAF INN
Burn



On the A19
'twixt the M62 and Selby
Tel: 01757 270614

www.wheatsheafburn.co.uk

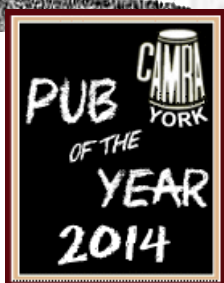

**Rotating Timothy Taylor Beers
One Dark Guest Hand Pull plus
Four Rotating Pale Guest Beers**

Home-cooked food every lunchtime
Evening meals served Wednesday - Saturday
Try our family Sunday Lunch

Open all day, every day - FREE HOUSE



ABOUT US

We are a small dedicated business who provide a professional service specialising in commercial, residential landscaping and sports pitch construction and maintenance.

We have over 20 years experience and offer a personal touch servicing customers in Yorkshire.

Recently topnic groundcare have partnered with Namgrass becoming their approved installers of artificial grass for this region.



MADE FOR LIVING

OUR SERVICES

- Drainage installation
- Complete maintenance packages
- End of season renovation packages
- Artificial grass installation
(Namgrass approved installers)
- Commercial & residential landscaping
- Digger and driver hire
- Verti-draining
- Scarifying
- Over seeding
- Topdressing
- Sand spreading
- Fertilising
- Weed control
- Mowing
- Decking
- Fencing
- Patios
- Turfing

GET IN TOUCH

For a non obligation quote with Richard Topping on any of the contact details below.



info@topnic.co.uk



07886 400264



www.topnic.co.uk



The next generation of telecommunications are here now!



Get Safer, Faster and Smarter than the competition by putting a Rainbow in your Cloud

5000 Inclusive minutes to 01, 02, 03 & 07
(15% limit on 03 numbers)



From **ONLY £9.99** per person per month

START SAVING NOW!

CONTACT RAINBOW IT SERVICES



01904 904125



sales@rainbowitservices.co.uk

Make your Smartphone a Sell Phone

grainmate

4 simple steps to sell your crops



1 Download the grainmate app



2 Check the futures

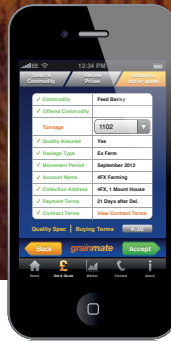

3 Get a quote in an instant

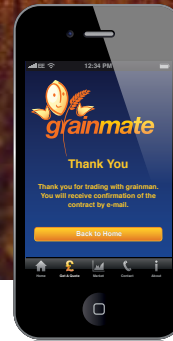

4 Sell your crops wherever you are!

Get the app and start trading direct from your mobile.

If you need help to download the app or have any queries please call and ask for the grainmate helpline 01844 261261



Log into



Only available to registered users of grainman™, just go to the App Store or Google Play and download the free iPhone or Android App.

THE FUTURE FOR YOUR GRAIN IS IN THE PALM OF YOUR HAND.

GLENCORE
AGRICULTURE UK LTD

GLENCORE AGRICULTURE UK LTD, WARREN HOUSE, BELL LANE, THAME OX9 3AL. TEL: 01844 261261

VIEW FROM THE BALCONY | REG PHILLIPS

We are pleased to welcome our visitors today from the historic city of Middlesbrough.

In 686, a monastic cell was consecrated by St. Cuthbert following a campaign of incessant nagging by his future wife, Hilda, Abbess of Whitby. In 1119 Robert Bruce, Lord of Cleveland and Annandale, converted the church of St. Hilda of Middleburg into the world's first Bingo Hall.

Before its final closure on the Dissolution of the Monasteries by Henry VIII in 1537, the church was maintained by 15 Benedictine monks, who became the first playing members of their newly formed local rugby club. Vicars, pastors, priests or rectors of various places in Cleveland were all made to feel welcome along with various other Celtic incomers, although Hilda & her nuns were persona nun grata.

The importance of the early church at "Middleburg", later known as Middlesbrough Priory, is indicated by the fact that, in 1452, it possessed four altars, until three of them were stolen by persons unknown, although the Celtic incomers were strongly suspected of having been put up to it by Hilda out of revenge

After the Angles, the area became home to Viking settlers who set the standard locally for rape & pillage that the area still upholds to this day. Names of Viking origin (with the suffix by) are abundant in the area – for example, Ormesby, Stainsby, Brianby and Fredby were once separate villages that belonged to Vikings called Orm, Steinn, Brian and Hagar, but now form suburbs of Middlesbrough. The name Mydilsburgh is the earliest recorded form of Middlesbrough's name and dates from the Anglo-Saxon ruler Thethil the Thyort tongue (AD 410–466), while many of the aforementioned villages are recorded in the Domesday Book of 1086.

Other links persist in the area, often through schools for unmarried mothers or mysterious road names, which cannot be identified because the road signs have been stolen. Or now-outgrown or abandoned local settlements, such as the medieval settlement of Doggingsby, deserted by 1757, which amounts to little more today than a series of grassy mounds near the A19 road.

In 1801, Middlesbrough was a small farm with a population of just 25, although the Rugby club boasted 563 members & five teams. During the latter half of the 19th century, however, it experienced rapid growth.

In 1828 the influential Quaker banker, coal mine owner and Viking descendant Joseph Pease sailed up the River Tees to find a suitable new site to sow his wild oats & investigate the current opportunities for rape & pillage. He located a site near Stockton which seemed more suitable, however to place new coal staithes.

As a result, in 1829 he and a group of Quaker businessmen bought the Middlesbrough farmstead and associated estate, some 527 acres (213 ha) of land, a failed nunnery, a failed monastery but a thriving unmarried mother's school, and established the Middlesbrough Estate Company. Through the company, the investors set about the development of a new coal port on the banks of the Tees nearby, and a suitable town, which originally included 447 back to back houses & 322 public houses on the site of the farm (the new town of Middlesbrough) to supply the port with labour.

By 1830 the S&DR had been extended to Middlesbrough and expansion of the town was assured. Of the 796 successful graduates from the established school a full 3% went on to become happily married. The small farmstead became the site of such streets as North Street, South Street, West Street, East Street, Hilda Street, Hagar Street and Thethil Threet, laid out in a grid-iron pattern around a market square, with the first house being built in Wedlock Street in April 1830. The town of Middlesbrough was born. New businesses quickly bought up premises and plots of land in the new town and soon shoppers, con merchants, butchers, bakers, candlestick makers, innkeepers, joiners, blacksmiths, tailors, builders and painters were moving in. Nuns & Monks, however were moving out and by 1851 Middlesbrough's population had grown from 40 people in 1829 to 7,600.

Enjoy your day

SRUFC New Board Profile: Mark Steward

Role on the Board: Chairman

First recollection of Selby RUFC: As a 7 year-old having a hot shower and a cup of soup after training, compared with Saturday morning football! Many things have changed, but hot showers are still an important part of the Rugby experience!

Rugby connections with Selby: Attended the first ever-mini rugby session held at Selby. As a new initiative, there was a role for every parent to get involved in any way they could. The values of the people involved in those early days and throughout my days as a junior player had a great influence on my development as a person. The structures that were in place have evolved to the club we enjoy today. I enjoyed playing Rugby at every level of the club and as a parent coached from under 7's to Under 16s. For a period holding the position of Youth Chairman. I feel privileged to have played alongside many of our senior members and some of the fathers of our youngest members.

My Role: In addition to chairing the Board meetings my role is to ensure the Directors fulfil their responsibilities and work together to achieve the club's objectives. I am passionate about promoting and maintaining the values of Rugby throughout the Club and that the Club prospers in its amateur status of being the best we can be with the players we have and that rugby continues to be available to all who wish to enjoy this great game.

Why did I get involved?: Somebody asked me and I am rubbish at saying no!

People who had most influence on me at Selby RUFC: Mike Magee, John Lancaster and the late Geoff Foster, all who were my coaches but are and were champions of all rugby and Selby RUFC is all about on and off the Pitch.

Fond memories: Winning the Selby Festival at our final attempt; Winning the Yorkshire Shield and all the junior rugby tours!



Garbutt + Elliott

is proud to support:

Selby Rugby Club



Accounting + Purpose

Leeds: 33 Park Place, Leeds LS1 2RY **Tel:** +44 (0)113 273 9600

York: Arabesque House, Monks Cross Drive, York YO32 9GW **Tel:** +44 (0)1904 464100

Garbutt + Elliott is the trading name of Garbutt & Elliott LLP (Limited Liability Partnership). Partnership No. OC346021 (England & Wales). Registered Office: Arabesque House, Monks Cross Drive, York, YO32 9GW. A full list of members is available at this address.



Vantage Toyota York



TOYOTA

ALWAYS A
BETTER WAY

Proudly supporting
Selby RUFC
and Grass Roots
Rugby Union.



Exclusive Offers for Club Members

ALL MAKES
& MODELS
SERVICING
FROM ONLY

£89

MOT
FOR ONLY
£30

15%
OFF
PARTS AND
LABOUR

Vantage

Vantage Toyota
Clifton Moor Gate,
York YO30 4WR
Tel: 01904 231 203



vantage.toyota.co.uk

[/vantagemotorgroup](https://www.facebook.com/vantagemotorgroup)

[@vantagemotorgrp](https://twitter.com/vantagemotorgrp)

Terms and conditions apply. Cannot be used in conjunction with any other offer.

115188J





DIGITALLY DEDICATED

Baltic are a tech focused training provider dedicated to supporting businesses, employees and young people through apprenticeships.

Our vision is to champion change and constantly look to the future, to change the way people learn and positively shift the perception of apprenticeships.

**BE THE
FUTURE**

 www.baltictraining.com

 @BalticApprenticeships

 @BalticTraining

 BalticTraining

 01325 731 050



Buy Today with NOTHING to pay for a whole year
 or after 12 months spread the cost at 19.9% Representative see website for details.

HURRY we have started running our Autumn Event

Don't delay as limited dates are available. It will be a first come, first served basis.

WINDOWS | DOORS | FASCIAS & SOFFITS
 WIDE RANGE OF ORANGERIES CONSERVATORIES
 SMALL EXTENSIONS

All our products are high on security and energy efficiency.

MASSIVE AUTUMN SAVINGS UP TO 32% OFF

01904 360 065 / 08000 436 005

Eliments



After sales service second to none. Free no obligation quotation. We are North Yorkshire's leading home improvement company where quality needn't cost the Earth!

NEW SHOWROOM NOW OPEN
 Free and easy car parking. Open 7 days a week.
 Visit www.eliments.co.uk for more information
FINANCE OPTION AVAILABLE - ask for details

Eliments, Bell Farm, Ricall Road (A19), Escrick, York, YO19 6ED (5 miles from Designer Outlet)
 Credit is subject to application and status. Eliments Ltd is authorised and regulated by the Financial Conduct Authority

waingap

CONTRACTS LIMITED

Committed to Excellence





STRUCTURAL STEELWORK SPECIALISTS

Billington Structures is one of the UK's leading structural steelwork contractors, offering a professional service for over 60 years.

Our experienced workforce can tackle projects from simple building frames to the most complex structures in excess of 6,000 tonnes. With plants in Barnsley and Bristol we have the capability to process 25,000 tonnes of steel per annum, and are able to service clients at locations throughout the UK and Europe.

OUR PROCESS



COMMERCIAL



DESIGN



PROCUREMENT



MANUFACTURE



INSTALLATION

CALL US ON 01226 340666
ENQUIRIES@BILLINGTON-STRUCTURES.CO.UK
WWW.BILLINGTON-STRUCTURES.CO.UK



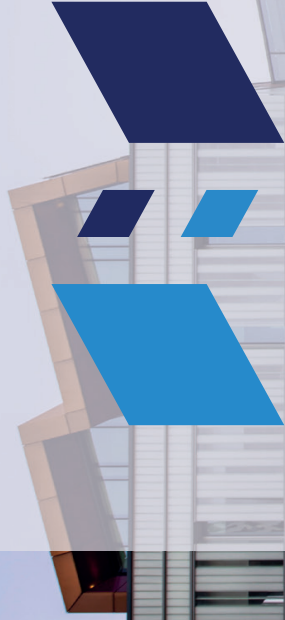

Horbury Group

The Horbury Group provides a complete national service to the construction industry, which includes:

- Drying and Partitioning
- Joinery
- Suspended Ceilings
- Carpets, Vinyl and Timber Flooring
- SFS
- External Facades and Cladding
- Full Fit-Out
- Refurbishment and Maintenance
- Demountable Glazed Screens
- Decoration
- Structural Fire Protection
- External Wall Insulation

Contact us - telephone: 01709 515044 or email: enquiries@horburygroup.com

Keighley RUFC 14 v 20 Selby RUFC Report by Ian Marlow

Selby moved further away from the Yorkshire One relegation positions by toughing it out and leaving it late for the second week running to snatch the victory and points in a tight, bruising match away at Keighley. And while there is an old rugby maxim that says 'if you win the breakdown, you win the match', this match was proof indeed to pay no attention to perceived wisdom as Selby broke the world record for lost possessions but still came away with a well-merited win.

Playing into a stiffish breeze Selby didn't wait long to demonstrate their legendary generosity by kicking out on the full from the kick off and then conceding a soft penalty to put Keighley in prime position on their line – but prop Millar McCoy turned the ball over excellently to save the day. Play then concentrated in midfield as both teams showed their mettle with some mean tackling before second row Stephen Clark ran a beautiful line to hit the ball at pace and scorch through the defensive line for a seemingly certain and fabulous try. Unfortunately, a last ditch tap tackle upended the ginger galloper and the chance was lost, and then to compound Selby's disappointment Keighley put together a cracking back move of their own to send their centre in for a 7-0 lead after 15 minutes.

With Keighley now dominating the breakdowns the chance for Selby to establish any decent possession and field position was scant and when a clash of heads removed both captain Charlie Cicero and fly half Harry Cruise from any further involvement in the game, the Swans and their chances of victory were starting to look a bit bedraggled. Then out of nowhere Selby scored a cracking try as a quick tap penalty from acting captain and scrum half Danny Wilkinson from an innocuous position deep in his own half was moved deftly on by young centre Ollly Turvey to winger Ash Dallimore, who simply blistered up the touchline leaving the Keighley cover for dead to streak in from 60 metres to tie the scores after 30 minutes.

Selby's chronic inability to hang onto the ball at the breakdown then returned to cost them as Keighley took advantage of two consecutive turned over possessions to score again for a 14-7 lead and then, after Liam Hogan senselessly binned himself, the Swans were left desperately hanging on until half time as Keighley pushed for another score to take the match away.

With hooker James Dentith having to leave the field at half time with another head injury and with Dallimore and centre Alex Webster also now struggling with leg injuries Selby, with no remaining substitutes, were starting to resemble the walking dead - but it is a measure of their much improved resilience that this didn't affect their defensive capabilities as they denied Keighley any second half scoring opportunities. The problem for Selby was that their troubles at the breakdown continued unabated, so despite the pack dominating the scrummage the Swans never had the ball long enough to do any damage themselves.

However, with time fast running out Selby suddenly started to get firmly on top as the pack, with Clark and New Zealander new boy Sam Phipps leading the way, started to get a real grind on their opposition - and it was great to see young hooker Charlie Thompson, a late replacement call up, stepping up to the mark when needed and getting stuck in to play a full part in Selby's recovery. After a break from Webster set up field position, the pack did the rest as they drove over for young but portly Sam Broughton to touch down and then after Selby's scrum forced another penalty, full back George Stoker stroked it over to take the lead 14-15. And there was still time for Wilkinson and winger Matt Leetham to break blind to take play deep into Keighley territory where the pack, once again, asserted their dominance by forcing their way over for Broughton, or maybe Wilkinson, or maybe neither, to touch down for the 14-20 win.

Selby now take on Middlesbrough in a league and Yorkshire Shield double header at home on Saturday – and, while Selby's commitment and durability are not in doubt, coaches and players will be focussing on improving their ball control if they are to have any chance against the promotion favourites.





A Huge Thankyou To All Our Sponsors



A. Grundy - Funeral Directors
Abbey Coachways Ltd
Adina Developments Ltd
Alan Dalton (Outwood) Ltd
Anna's Happy Trotters
Antix Trading
Arc Signs
Ashworth Plumbing
Billington Holdings plc
Bridge EHRS Ltd
Brown Cow Brewery
Burn Fencing Ltd
Cathedral Hygiene
Chucks & Cheese
Clissors HK Ltd
Collinson & Stelling, Auto
Crombie Wilkinson Solicitors
Cropwise
David Everatt - Coal Merchant
D E Ford Risk Management
Elmhirst Parker
Farmstar Ltd
For Farmers
Gallop Racing Syndicate
Garbutt & Elliott
Glencore Grain UK Ltd
Heineken
H F Brown & Son Ltd
J Bramley & Son
JWCREERS LLP
Kukri Sports Ltd
Les Bernots
Michael Walton
Mone Bros DIY

Nigel Adams MP
One360 Marketing Ltd
Park Lodge Shooting School
Peter & David Bramley
Peter Foster
Planet Platforms Ltd
R&N Landscaping Services
Read School
Robert Lowery Roofing
RugbyTel Ltd
S J Stockdale Executive Cars
S.B Cook
SCALM PARK LEISURE
Selby Cricket Club
Selby Foods Ltd
Selby Times
Stephen Ward
Taperell Environmental Ltd
TopNic
The Muffits
The Wheatsheaf Inn
Thorpe Cars
Tiger Print
Townends Accountants
Upton Vending Ltd
Vantage Toyota York
WashEmpress
WainGap Contracts Ltd
Webster & Co Ltd
West Riding Paper Services
Wholecrop Marketing Ltd
Willsden Steel Ltd
World of Rhubarb