

V² *iLumenAir* 900 CE

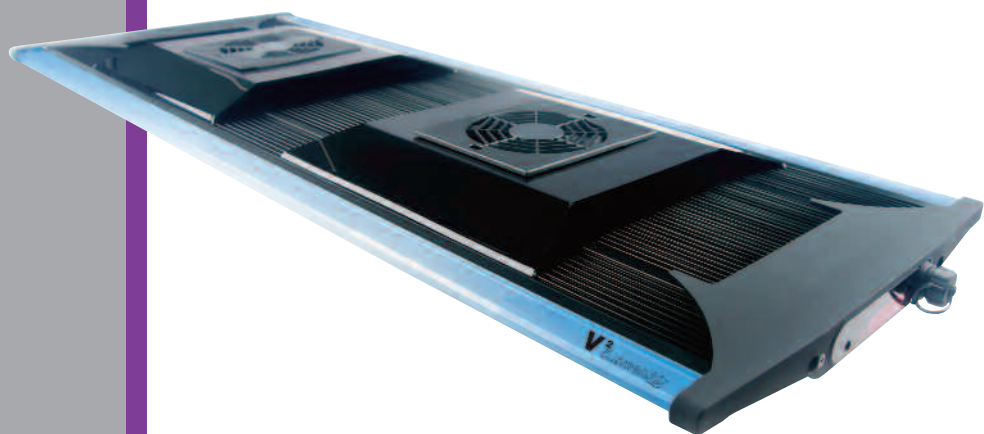



ENGLISH 1
FRANÇAIS 10
DEUTSCH 19
ESPAÑOL 28
PORTUGUÊS 37
ITALIANO 46
NEDERLANDS 55

V²iLumenAir 900

INSTRUCTIONS FOR INSTALLATION AND USE

Important Safety Information - Please Read Carefully

- **Caution:** Do not use any other power supply unit with the V²iLumenAir as the light unit may not work and this may cause irreparable damage to the light unit. If the PSU supplied with the unit needs to be replaced then please obtain an authentic V²iLumenAir PSU supplied by one of Tropical Marine Centre's local stockists. 
- Always isolate the PSU from the mains electricity before installing or carrying out any maintenance.
- **Caution:** Do not operate this appliance if any part of it has a damaged cord or plug, is malfunctioning, or has been dropped, immersed in water or damaged in any way. If the external cord of this unit is damaged, it should be replaced by a cord exclusively available from the manufacturer or his service agent.
- This unit is designed to be used indoors and is not suitable for any outdoor applications. 
- **Caution:** Ensure the light unit is securely installed above the tank before operating.
- **Caution:** Always leave a drip-loop in the DC supply cable to the V²iLumenAir light unit to prevent water running down the cable and reaching the PSU (see picture below).
- **Caution:** Do not splash or submerge the lamp or power supply.
- **Caution:** Do not obstruct the cooling fans in any way.
- To prolong the life of your lamp unit please ensure that it is kept free of dust, salt and other debris.
- Dispose of this unit responsibly. Check with your local authority for disposal information. 

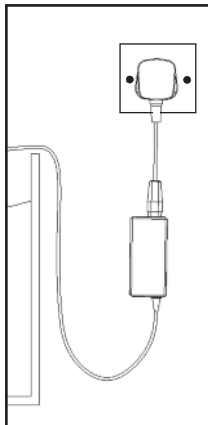

Product Specification

Model: V²iLumenAir 900

Size: 690x260x24mm

Suitable for tanks 730 -1200mm long x 300-880mm wide

Input: 100-240V 50/60Hz

Total Power: 179W

Total Luminous Flux: 9000lm

Parts List

Please ensure that you have all parts shown below.

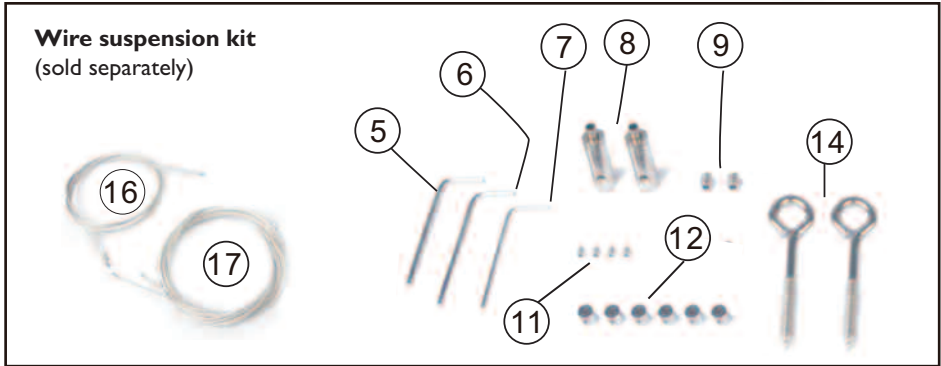

Installation

The V²iLumenAir can be mounted via the tank mounting kit (supplied) or wire suspension kit (sold separately).

a. Tank Mounting

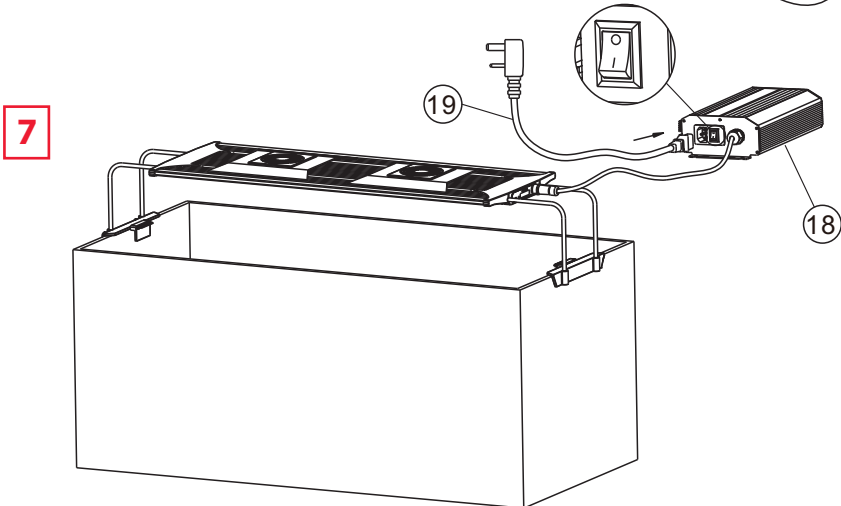
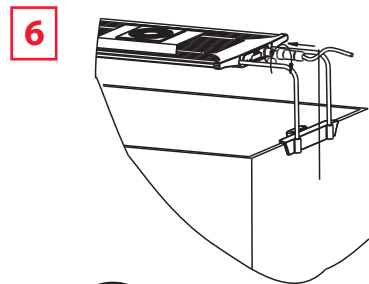
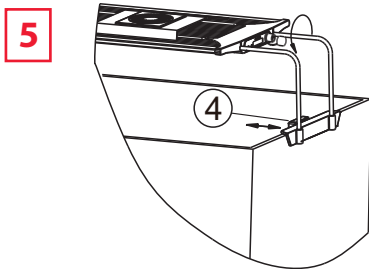
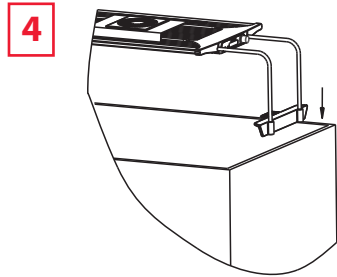
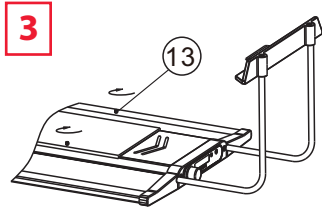
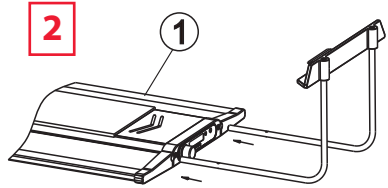
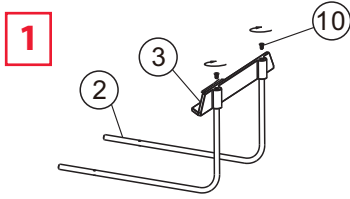

b. Wire Suspension

1

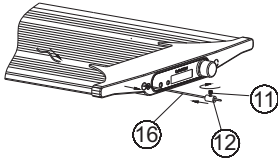

2

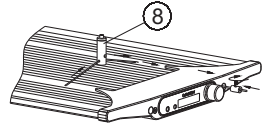

3

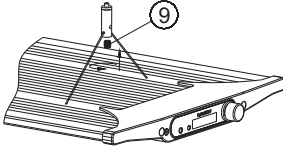

4

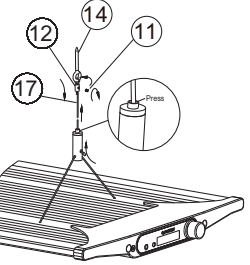

5

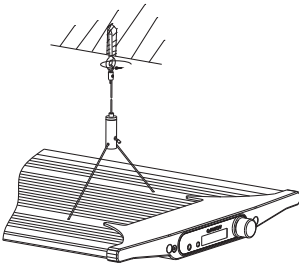

6

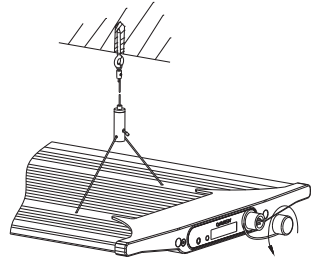

7

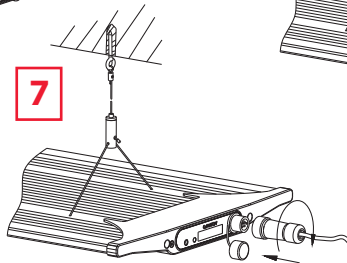

8

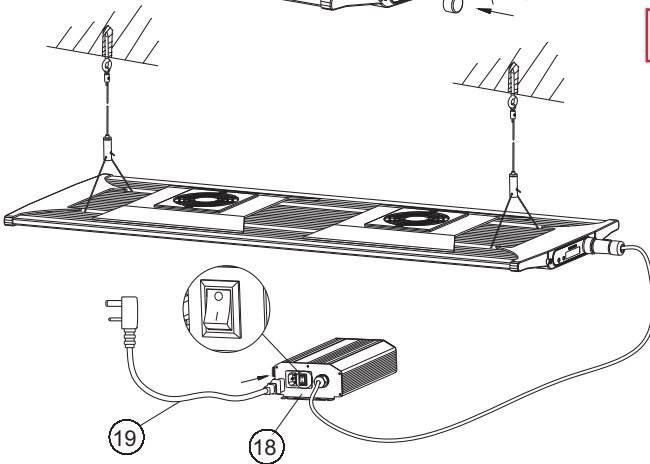





9



Remove the clear plastic tab from the remote control

Display Screen



-  shows when in daytime phase
-  shows when in sunrise or sunset phase
-  shows when in dawn or moonlight phase
-  shows when the light is off

- In run mode the display shows the time in either 24 or 12 hour clock format.
- When setting the phases the first digit represents the time period you are setting:-
 - 1 indicates dawn
 - 2 indicates sunrise
 - 3 indicates daytime
 - 4 indicates sunset
 - 5 indicates moonlight.
- The letter represents which LED channel you are setting:-
 - A is the white channel
 - b is the blue channel
 - C is the colour mix
- The last two digits indicate the brightness level of the channel from '00' to '32'.
- In storm mode the display indicates the frequency of lightning strikes from '1' to '8'.
- In colour demo mode the display indicates the frequency of colour variation from 'Co01' to 'Co12'.
- If the display shows  that means that this fixture is a slave to another control unit.

Operating Instructions

Quick start

1. Ensure the clear plastic battery protection tab is removed from the bottom of the remote control (see page 4).

2. To use the remote control, point it at the infrared sensor at the cable entry to the light unit.

3. Press  to set the clock. Press once to adjust the hour and twice to adjust the minute.



Use  and  to adjust up or down.

The time setting will be automatically saved after ten seconds, or you can press  to go back to your user set program with the updated time.

4. Press  to choose between 24 hour and 12 hour clock format.

5. Press  to run the set program (details of the factory set program on page 8).

6. Press  to switch the light off.

7. Press  to enter storm mode. Use  and  to change the frequency of lightning strikes.

Press  to return to the set program.

8. Press  to enter a colour demo. Use  and  to change the speed of the transitions.







































In the slowest settings this can be used to simulate clouds passing over. Press  to return to the set program.

9. Press  repeatedly to cycle the display through, showing the temperature of the light unit in °C and °F and the electrical power being drawn by the light unit in Watts.

10. Press  to slave the unit from another controller (sold separately).



Programming

1. Press  to set the start time for your photoperiod. Press once to adjust the hour and twice to adjust the minute. Use  and  to adjust up or down.
2. Press  to save your settings.
3. Press  to set the **dawn** phase duration. Press once to adjust the hours and twice to adjust the minutes. Use  and  to adjust up or down.
4. Press  repeatedly to choose between the white, blue and colour mixing channel. Adjust the brightness of each channel using  and  to create your preferred dawn effect.
5. Press  to save your settings.
6. Press  to set the **sunrise** phase duration. Press once to adjust the hours and twice to adjust the minutes. Use  and  to adjust up or down.
7. Press  repeatedly to choose between the white, blue and colour mixing channel. Adjust the brightness of each channel using  and  to create your preferred sunrise effect.
8. Press  to save your settings.
9. Press  to set the **daytime** phase duration. Press once to adjust the hours and twice to adjust the minutes. Use  and  to adjust up or down.
10. Press  repeatedly to choose between the white, blue and colour mixing channel. Adjust the brightness of each channel using  and  to create your preferred daytime effect.
11. Press  to save your settings.
12. Press  to set the **sunset** phase duration. Press once to adjust the hours and twice to adjust the minutes. Use  and  to adjust up or down.
13. Press  repeatedly to choose between the white, blue and colour mixing channel. Adjust the brightness of each channel using  and  to create your preferred sunset effect.
14. Press  to save your settings.
15. Press  to set the **moonlight** phase duration. Press once to adjust the hours and twice to adjust the minutes. Use  and  to adjust up or down.
16. Press  repeatedly to choose between the white, blue and colour mixing channel. Adjust the brightness of each channel using  and  to create your preferred moonlight effect.
17. Press  to save your settings.

Once you have set your program, you can see a demo of your settings by pressing . This will run through the 24 hour photoperiod in just over 2 minutes (1 second = 10 minutes of the cycle).

NOTE: If the total number of hours in your photoperiod is less than 24 hours then the light will turn off after the moonlight phase and will come on again at the start time. If the total is more than 24 hours then the part over 24 hours will be overridden by the dawn at the set start time.

Daylight Recommendations

The suggestions below are for guidance purposes only. Corals can be kept in deeper aquariums. Please note that it is up to you to ensure that your corals receive the correct amount of light. Refer to your local fish store if you are unsure.

Small Polyp Stony Coral

All channels 100% (32) for 60cm+ deep tanks

All channels 90% (29) for 45cm deep tanks

All channels 75% (24) for 30cm deep tanks

Large Polyp Stony Coral

All channels 75% (24) for 60cm deep tanks

All channels 65% (20) for 45cm deep tanks

All channels 55% (17) for 30cm deep tanks

Soft Coral











All channels 65% (20) for 60cm deep tanks

All channels 55% (17) for 45cm deep tanks

All channels 45% (14) for 30cm deep tanks

Factory Settings

To reset to the factory settings press  then .

Functions	Buttons	Start Time/ Duration	Set Brightness		
			White	Blue	Colour Mix
Light Start time		05:00 (start time)	-	-	-
Dawn duration & colour	 	02:00	1A 01	1B 01	1C 01
Sunrise duration & colour	 	01:00	2A 10	2B 05	2C 28
Daytime duration & colour	 	10:00	3A 28	3B 28	3C 28
Sunset duration & colour	 	02:00	4A 15	4B 10	4C 30
Moonlight duration & colour	 	03:00	5A 02	5B 10	5C 02

Over Temperature Protection

The smart fans will start to work when the lights are on full, or the temperature of the light is over 38°C (100°F) and will stop when it cools to around 34°C (93°F). If the unit gets too hot, at around 60°C (140°F), the light will shut down and the display will show 

Blue LED Trim Operation

To control the blue LED trim, point the remote control at the infrared sensor on the light unit at the opposite end from the cable entry.









Press  and  to change the brightness of the blue LED trim up and down.

Press  to turn it off and  to turn it back on again.



If you press  the trim will automatically dim and brighten to create a pulsing effect.

Troubleshooting

The light does not work

1. Check that it is connected to the power. If not, connect it.
2. Check if the light is in slave mode or off (display showing  or ). If so press  to return to run mode.
3. Check if the brightness is set to '0'. Press  or  or  or  or  to adjust the brightness level.
4. Check that the light is not supposed to be off according to your set program. Refer to page 7 to adjust the program.



The light is always on

1. Check if the total photoperiod is over 24 hours in duration. Refer to page 7 to adjust the program.
2. Check the time is set correctly. Press  and  or  to set the time.

The screen displays

1. Check if the top of the unit and fans are blocked or covered. If they are, remove dust/debris to ensure good air flow.
2. Check if the fans are operating. If not then refer to Tropical Marine Centre or your local dealer for replacement fans.

The remote control does not work

1. Check if the light is in slave mode or off (display showing  or ). If so press  to return to run mode.
2. Check that the remote control is pointing to the correct infrared sensor on the light unit for the operation you are trying to perform. Refer to page 6.
3. Check the battery. This can easily be replaced with a CR2032 coin cell.

The light is flashing

1. Ensure that the light isn't in storm or demo mode. Press  to return to run mode.

V²iLumenAir 900

NOTICE D'INSTALLATION ET MODE D'EMPLOI

Notice de sécurité importante – A lire attentivement

- **Attention** : Ne pas utiliser la lampe V²iLumenAir avec d'autres blocs d'alimentation car il se peut qu'elle ne fonctionne pas et qu'elle soit endommagée de manière irréparable. Si le bloc d'alimentation fourni avec l'unité doit être remplacé, veuillez obtenir un bloc d'alimentation V²iLumenAir authentique auprès d'un distributeur de produits Tropical Marine Centre.



- Débranchez toujours le bloc d'alimentation du courant de secteur avant d'installer la lampe ou de procéder à un entretien.
- **Attention** : N'utilisez pas cet appareil si l'une de ses pièces a un cordon ou une fiche endommagée, s'il ne fonctionne pas correctement, s'il a subi une chute, s'il a été immergé dans de l'eau ou endommagé d'une manière quelconque. Si le cordon externe de cette unité est endommagé, il doit être remplacé par un cordon exclusivement disponible auprès du fabricant ou de son agent de service.

- Cette unité est prévue pour usage dans un endroit couvert et ne convient pas aux applications en plein air.



- **Attention** : Veillez à ce que la lampe soit installée en toute sécurité au-dessus de l'aquarium avant de l'utiliser.

- **Attention** : Veillez à toujours inclure une boucle d'égouttement dans le câble d'alimentation cc de la lampe V²iLumenAir pour empêcher que l'eau ne coule le long du câble et n'atteigne le bloc d'alimentation (voir l'illustration ci-dessous).

- **Attention** : N'éclaboussez pas la lampe ou l'alimentation électrique, ne les plongez pas dans l'eau.

- **Attention** : N'obstruez pas les ventilateurs de refroidissement, de quelque manière que ce soit.

- Pour prolonger la vie de vos lampes, veillez à ce qu'elles restent exemptes de poussières, sel et autres corps étrangers.

- Veuillez éliminer cette unité correctement. Vérifiez le mode d'élimination recommandé auprès de vos autorités locales.

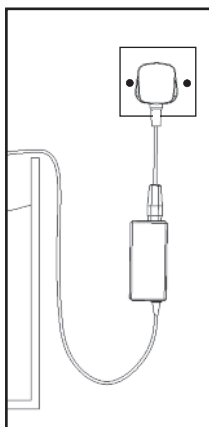

Spécification du Produit

Modèle: V²iLumenAir 900

Dimensions: 690 x 260 x 24 mm

Convient aux aquariums de 730 - l 200 mm de long x 300-880 mm de large

Alimentation: 100-240 V, 50/60 Hz

Puissance totale: 179 W

Flux lumineux total: 9000 lm

Liste des Pièces

Assurez-vous que vous disposez de toutes les pièces ci-dessous.



Kit de suspension par câble

(vendu séparément)

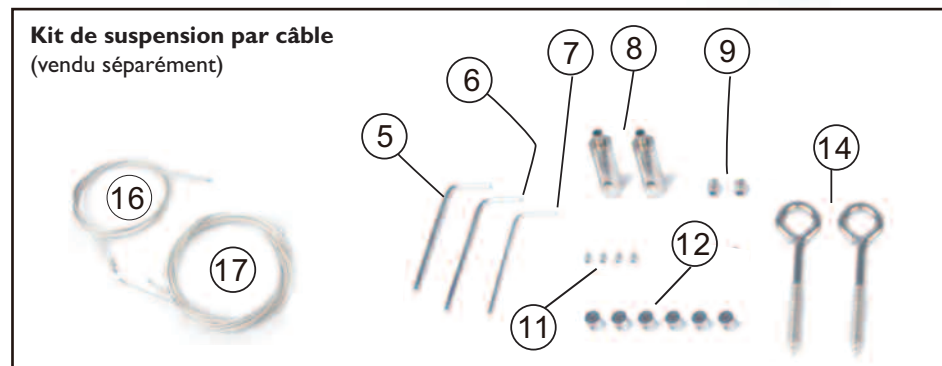

Installation

Le V²iLumenAir peut être monté à l'aide du kit de montage sur aquarium (fourni) ou du kit de suspension par câble (vendu séparément).

a. Montage sur Aquarium

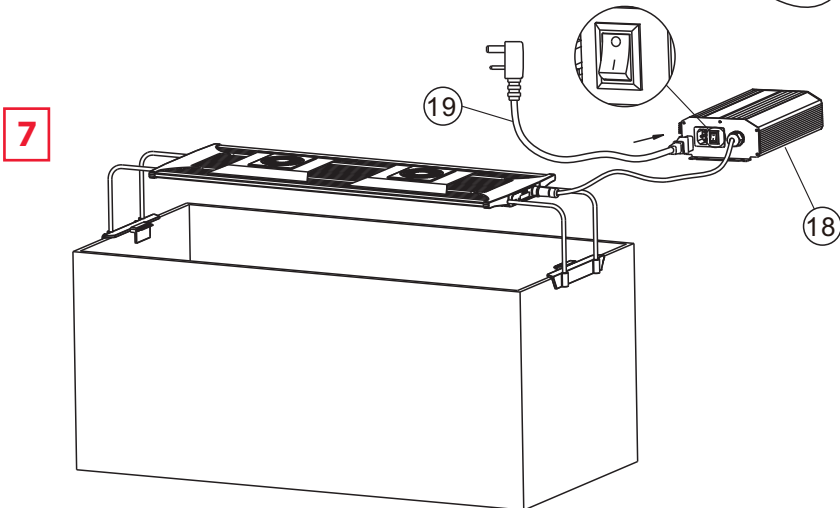
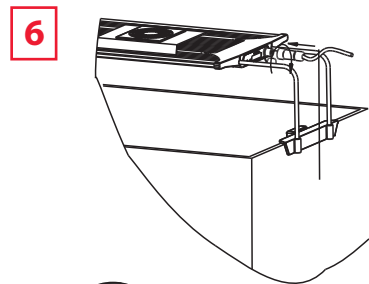
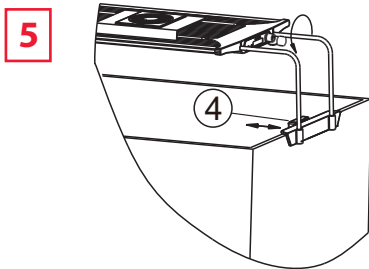
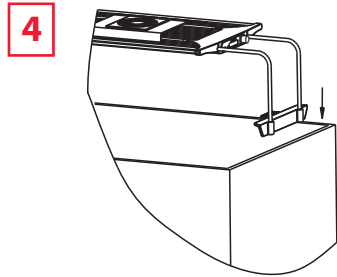
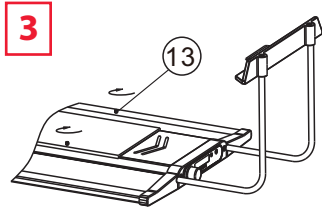
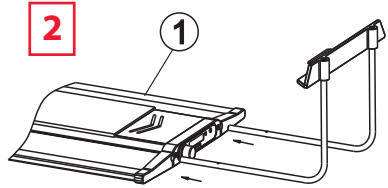
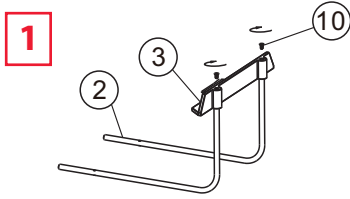



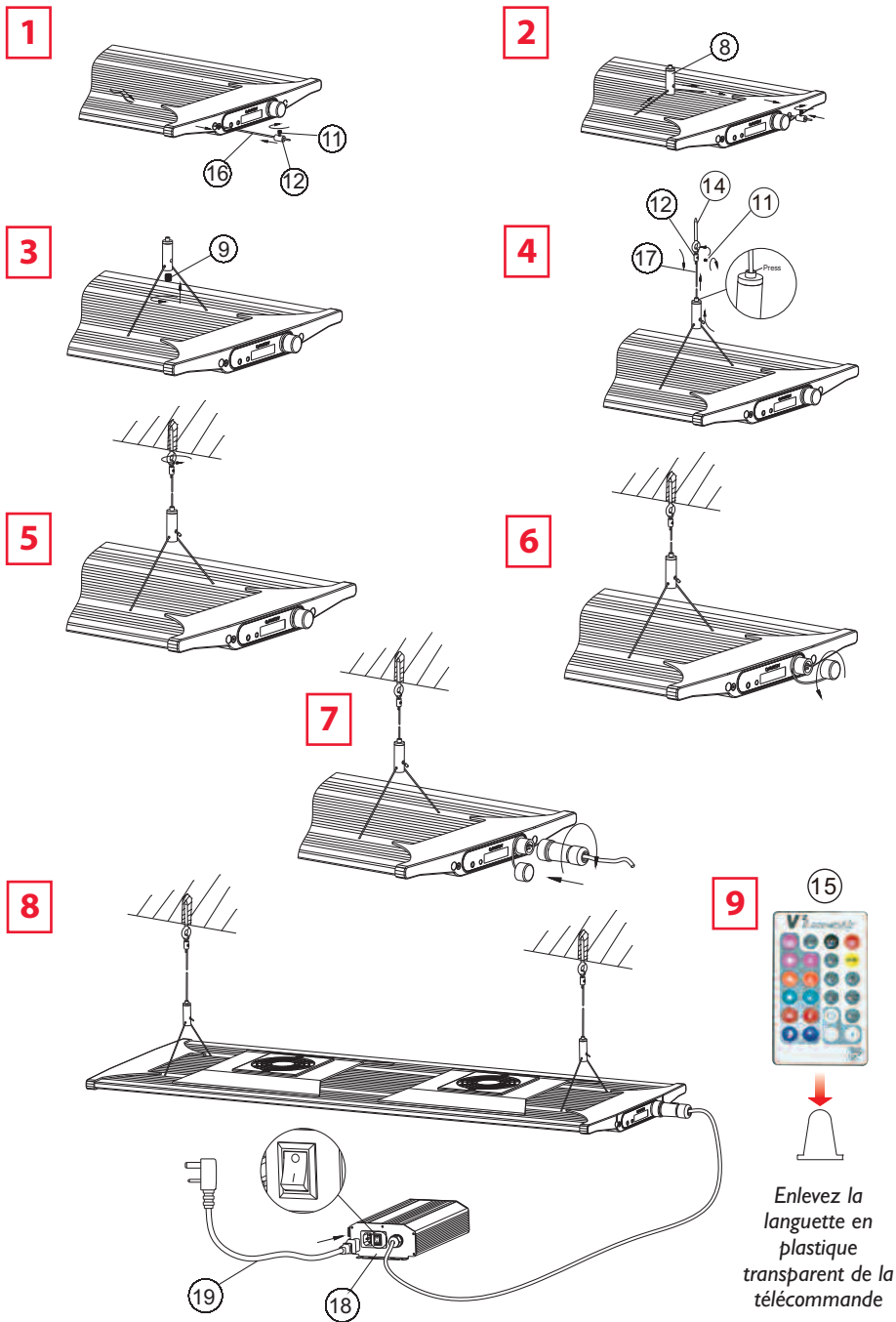

b. Suspension par Câble



Écran d'affichage





-  s'affiche en phase de jour
-  s'affiche en phase de lever ou de coucher de soleil
-  s'affiche en phase de crépuscule ou de clair de lune
-  s'affiche lorsque l'éclairage est éteint

- En mode exécution, l'affichage indique l'heure au format 12 heures ou 24 heures.
- Lorsque vous réglez les phases, le premier chiffre indique la période en cours de réglage.
 - 1 indique l'aube
 - 2 indique le lever de soleil
 - 3 indique le jour
 - 4 indique le coucher de soleil
 - 5 indique le clair de lune
- La lettre indique le canal de LED en cours de réglage.
 - « A » correspond au canal blanc
 - « b » au canal bleu
 - « C » au canal de mélange de couleurs
- Les deux derniers chiffres indiquent le niveau de luminosité du canal, compris entre 00 et 32.
- En mode tempête, l'affichage indique la fréquence des éclairs, comprise entre 1 et 8.
- En mode démonstration des couleurs, l'affichage indique la fréquence des changements de couleur, comprise entre « Co01 » et « Co12 ».
- L'affichage de  indique que l'appareil d'éclairage est esclave d'un autre contrôleur.







Instructions d'utilisation

Démarrage rapide







1. Veillez à retirer la languette de protection de la pile en plastique transparent de la partie inférieure du contrôleur (voir page 13).
2. Pour utiliser la télécommande, dirigez-la vers le capteur infrarouge situé au niveau de l'entrée de câble de l'appareil d'éclairage.
3. Appuyez sur  pour régler l'horloge. Appuyez une fois pour régler l'heure et deux fois pour régler les minutes.

Utilisez   pour augmenter ou diminuer.

Le réglage de l'heure est automatiquement sauvegardé au bout de 10 secondes. Vous pouvez aussi appuyer sur  pour revenir au programme que vous avez défini avec l'heure mise à jour.







































4. Appuyez sur  pour sélectionner le format 12 heures ou 24 heures.
5. Appuyez sur  pour exécuter le programme que vous avez défini (détails du programme défini en usine page 17).
6. Appuyez sur  pour éteindre la lumière.
7. Appuyez sur  pour passer en mode tempête. Appuyez sur   pour modifier la fréquence des éclairs.

Appuyez sur  pour revenir au programme que vous avez défini..

8. Appuyez sur  pour saisir une démonstration de couleurs. Appuyez sur   pour modifier la vitesse des transitions. Le réglage sur la valeur la plus faible permet de simuler le passage de nuages. Appuyez sur  pour revenir au programme que vous avez défini.
9. Appuyez plusieurs fois sur  pour sélectionner l'affichage de la température de l'appareil d'éclairage en °C ou en °F, ainsi que la puissance consommée de l'appareil en Watts.
10. Appuyez sur  pour enregistrer l'appareil en tant qu'esclave d'un autre contrôleur (vendu séparément).



Programmation

1. Appuyez sur  pour régler l'heure de début de votre photopériode. Appuyez une fois pour régler l'heure et deux fois pour régler les minutes. Utilisez   pour augmenter ou diminuer.
2. Appuyez sur  pour sauvegarder vos réglages.
3. Appuyez sur  pour régler la durée de **l'aube**. Appuyez une fois pour régler l'heure et deux fois pour régler les minutes. Utilisez   pour augmenter ou diminuer.
4. Appuyez plusieurs fois sur  pour sélectionner le canal (blanc, bleu ou mélange de couleurs). Réglez la luminosité de chaque canal à l'aide de   pour créer l'effet d'aube désiré.
5. Appuyez sur  pour sauvegarder vos réglages.
6. Appuyez sur  pour régler la durée du **lever de soleil**. Appuyez une fois pour régler l'heure et deux fois pour régler les minutes. Utilisez   pour augmenter ou diminuer.
7. Appuyez plusieurs fois sur  pour sélectionner le canal (blanc, bleu ou mélange de couleurs). Réglez la luminosité de chaque canal à l'aide de   pour créer l'effet de lever de soleil désiré.
8. Appuyez sur  pour sauvegarder vos réglages.
9. Appuyez sur  pour régler la durée du **jour**. Appuyez une fois pour régler l'heure et deux fois pour régler les minutes. Utilisez   pour augmenter ou diminuer.
10. Appuyez plusieurs fois sur  pour sélectionner le canal (blanc, bleu ou mélange de couleurs). Réglez la luminosité de chaque canal à l'aide de   pour créer l'effet de jour désiré.
11. Appuyez sur  pour sauvegarder vos réglages.
12. Appuyez sur  pour régler la durée du **coucher de soleil**. Appuyez une fois pour régler l'heure et deux fois pour régler les minutes. Utilisez   pour augmenter ou diminuer.
13. Appuyez plusieurs fois sur  pour sélectionner le canal (blanc, bleu ou mélange de couleurs). Réglez la luminosité de chaque canal à l'aide de   pour créer l'effet de coucher de soleil désiré.
14. Appuyez sur  pour sauvegarder vos réglages.
15. Appuyez sur  pour régler la durée du **clair de lune**. Appuyez une fois pour régler l'heure et deux fois pour régler les minutes. Utilisez   pour augmenter ou diminuer.
16. Appuyez plusieurs fois sur  pour sélectionner le canal (blanc, bleu ou mélange de couleurs). Réglez la luminosité de chaque canal à l'aide de   pour créer l'effet de clair de lune désiré.
17. Appuyez sur  pour sauvegarder vos réglages.

Une fois votre programme défini, vous pouvez voir une démonstration de vos réglages en appuyant sur . Le cycle de la photopériode de 24 heures se déroule en un peu plus de 2 minutes (1 seconde = 10 minutes du cycle). **REMARQUE** : Si le nombre total d'heures de votre photopériode est inférieur à 24 heures, l'éclairage s'éteint après la phase de clair de lune et se rallume à l'heure de début du cycle. Si le nombre total d'heures est supérieur à 24 heures, les heures en excès sont remplacées par l'aube à l'heure de début du cycle définie.

Recommandations pour la Lumière du Jour

Les suggestions ci-dessous sont données uniquement à titre indicatif. Les coraux peuvent être conservés dans des aquariums profonds. Vous devez veiller à ce que vos coraux reçoivent la quantité de lumière nécessaire. En cas de doute, demandez conseil à votre animalerie spécialisée.

Coraux durs à petits polypes

Tous les canaux à 100 % (32) pour des aquariums de plus de 60 cm de profondeur

Tous les canaux à 90 % (29) pour des aquariums de 45 cm de profondeur

Tous les canaux à 75 % (24) pour des aquariums de 30 cm de profondeur

Coraux durs à gros polypes

Tous les canaux à 75 % (24) pour des aquariums de 60 cm de profondeur

Tous les canaux à 65 % (20) pour des aquariums de 45 cm de profondeur

Tous les canaux à 55 % (17) pour des aquariums de 30 cm de profondeur



Coraux mous







Tous les canaux à 65 % (20) pour des aquariums de 60 cm de profondeur

Tous les canaux à 55 % (17) pour des aquariums de 45 cm de profondeur

Tous les canaux à 45 % (14) pour des aquariums de 30 cm de profondeur

Réglages Usine

Pour revenir aux réglages usine, appuyez sur  puis sur .



Fonctions	Boutons	Heure de début/durée	Réglage de la luminosité		
			Blanc	Bleu	Mélange de couleurs
Heure de début de l'éclairage		05:00 (heure de début)	-	-	-
Durée de l'aube et couleur		02:00	1A 01	1B 01	1C 01
Durée du lever de soleil et couleur		01:00	2A 10	2B 05	2C 28
Durée du jour et couleur		10:00	3A 28	3B 28	3C 28
Durée du coucher de soleil et couleur		02:00	4A 15	4B 10	4C 30
Durée du clair de lune et couleur		03:00	5A 02	5B 10	5C 02

Protection contre la Surchauffe

Les ventilateurs intelligents démarrent lorsque les éclairages sont allumés à pleine puissance, ou que leur température est supérieure à 38 °C (100 °F) et s'arrêtent lorsque leur température est redescendue à 34 °C (93 °F). Si l'appareil devient trop chaud, à environ 60 °C (140 °F), la lumière s'éteint et l'affichage indique .

Fonctionnement de la bande de LED bleue

Pour commander la bande de LED bleue, dirigez la télécommande vers le capteur infrarouge de l'appareil d'éclairage situé du côté opposé à l'entrée de câble.









Appuyez sur   pour augmenter et réduire la luminosité de la bande de LED bleue.

Appuyez sur  pour l'éteindre et sur  pour la rallumer.



Si vous appuyez sur  la luminosité augmente et diminue automatiquement pour créer un effet de pulsation

Dépannage

L'éclairage ne fonctionne pas.

1. Vérifiez qu'il est bien raccordé à l'alimentation électrique. Si ce n'est pas le cas, raccordez-le.
2. Vérifiez si l'appareil d'éclairage est en mode esclave ou éteint (l'affichage indique  ou ).
Si c'est le cas, appuyez sur  pour revenir en mode exécution.
3. Vérifier si la luminosité est réglée sur 0. Appuyez sur  ou  ou  ou  ou  pour régler le niveau de luminosité.
4. Vérifiez que l'éclairage n'est pas censé être éteint selon le programme que vous avez défini. Référez-vous à la page 16 pour régler le programme.



L'éclairage est allumé en permanence.

1. Vérifiez si la durée de la photopériode totale est supérieure à 24 heures. Référez-vous à la page 16 pour régler le programme.
2. Vérifier que l'heure est réglée correctement. Appuyez sur  et   pour régler l'heure.

L'affichage indique .

1. Vérifiez si le dessus de l'appareil et les ventilateurs sont bloqués ou recouverts. Si c'est le cas, enlevez la poussière et les corps étrangers pour assurer un débit d'air correct.
2. Vérifiez si les ventilateurs fonctionnent. Si ce n'est pas le cas, adressez-vous à Tropical Marine Centre ou à votre revendeur local pour obtenir des ventilateurs de rechange.

La télécommande ne fonctionne pas

1. Vérifiez si l'appareil d'éclairage est en mode esclave ou éteint (l'affichage indique  ou ).
Si c'est le cas, appuyez sur  pour revenir en mode exécution.
2. Vérifiez que vous dirigez la télécommande vers le bon capteur infrarouge de l'appareil en fonction de l'opération que vous souhaitez réaliser. Référez-vous aux page 15.
3. Vérifiez la pile. Vous pouvez facilement la remplacer par une pile bouton CR2032.

L'éclairage clignote

1. Vérifiez que l'éclairage n'est pas en mode tempête ou démonstration. Appuyez sur  pour revenir en mode exécution.

V²iLumenAir 900

INSTALLATIONS- UND GEBRAUCHSANLEITUNG

Wichtige Sicherheitshinweise – Bitte sorgfältig durchlesen!

- **Achtung:** Es darf kein sonstiges Netzteil mit einer V²iLumenAir-Lampeneinheit verwendet werden, da die Lampeneinheit in diesem Fall nicht nur funktionsunfähig sein, sondern auch irreparable Schäden erleiden könnte. Falls das mit der Einheit gelieferte Netzteil ausgetauscht werden muss, beschaffen Sie bitte ein originales V²iLumenAir-Netzteil von einem lokalen Händler für Produkte von Tropical Marine Centre.
- Vor Installation oder Wartung Ihrer V²iLumenAir-Lampeneinheit immer zuerst die Stromversorgung zum Netzteil trennen.
- **Achtung:** Dieses Gerät nicht verwenden, wenn es ein beschädigtes Netzkabel oder einen beschädigten Netzstecker hat, einen Fehler aufweist oder fallen gelassen, in Wasser eingetaucht oder anderweitig beschädigt worden ist. Wenn das externe Anschlusskabel dieses Gerätes beschädigt ist, sollte dieses ausschließlich durch ein Kabel vom Hersteller oder dessen Kundendienst ersetzt werden.
- Das Gerät ist ausschließlich zur Verwendung im Innern von Gebäuden entworfen und eignet sich nicht zum Einsatz im Freien.
- **Achtung:** Stellen Sie vor der Inbetriebnahme der V²iLumenAir-Lampeneinheit sicher, dass das Gerät sicher über dem Tank installiert ist.
- **Achtung:** Verlegen Sie das GS-Kabel zur V²iLumenAir-Lampeneinheit immer mit einer Tropfschleife, um zu verhindern, dass Wasser am Kabel hinunter laufen und in das Netzteil eindringen kann (siehe folgende Abbildung).
- **Achtung:** Die Leuchten und das Netzteil vor Nässe schützen.
- **Achtung:** Die Kühlung immer frei lassen.
- Um die Lebensdauer des Leuchtsystems zu verlängern, das System vor Staub, Salz und anderen Verunreinigungen schützen.
- Dieses Gerät ordnungsgemäß entsorgen. Weitere Informationen über geltende Entsorgungsvorschriften erhalten Sie von Ihrer lokalen Umweltschutzbehörde.

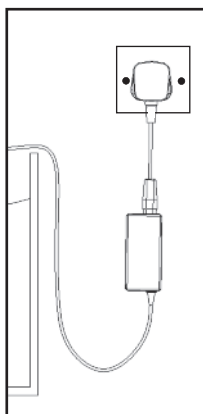

Produktspezifikation

Modell: V²iLumenAir 900

Größe: 690 x 260 x 24 mm

Geeignet für Becken von 730 bis 1200 mm Länge und 300 bis 880 mm Breite

Eingang: 100 bis 240V 50/60 Hz

Gesamtleistung: 179 W

Lichtstrom gesamt: 9000 lm

Teileliste

Vergewissern Sie sich, dass alle unten angegebenen Teile vorhanden sind.

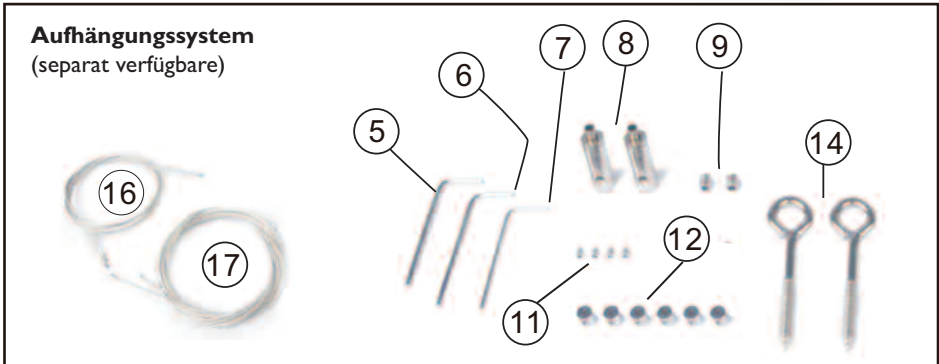
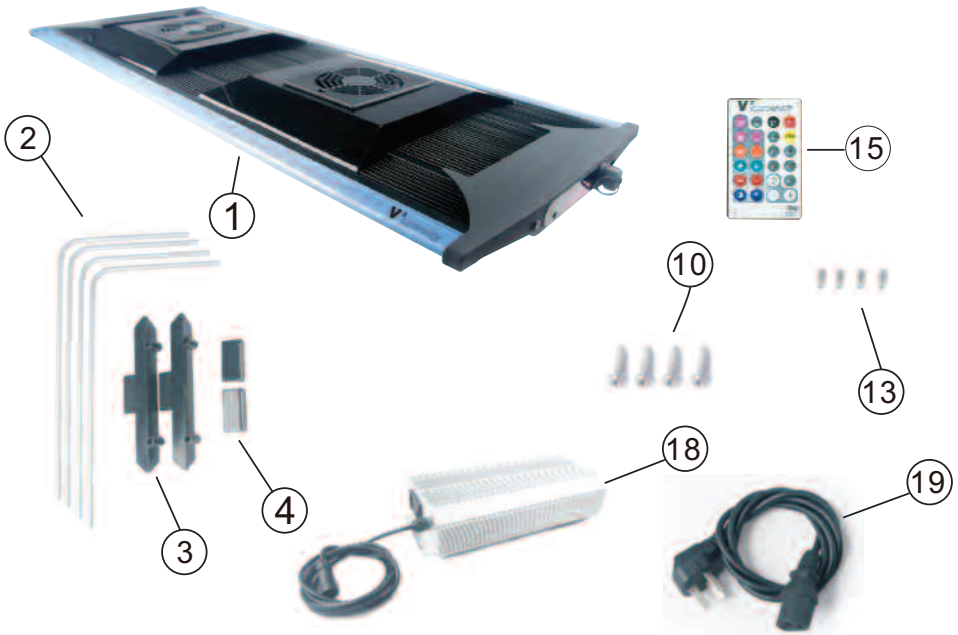

Installation

V²iLumenAirkann über ein (im Lieferumfang enthaltenes) Einhängesystem oder eine (separat verfügbare) Aufhängung angebracht werden.

a. Einhängesystem

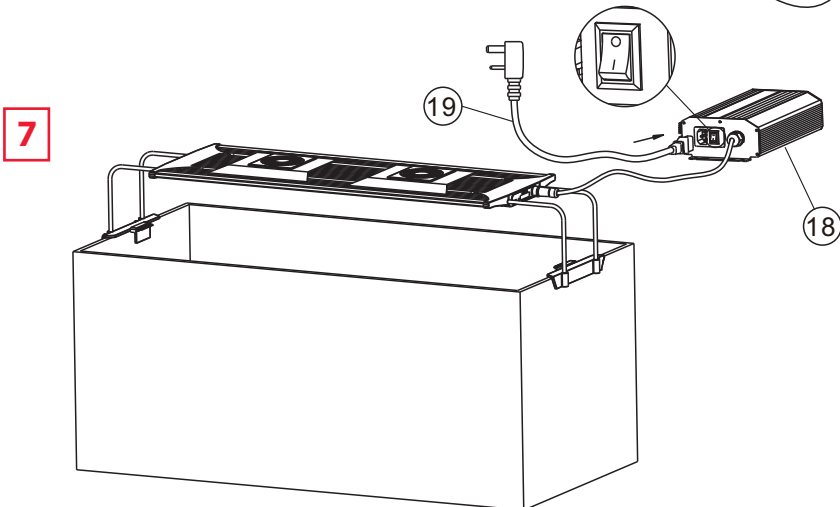
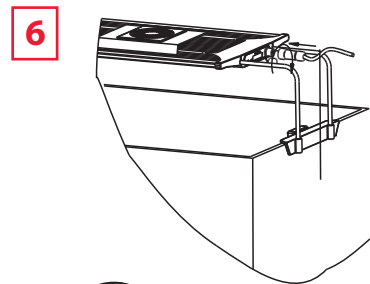
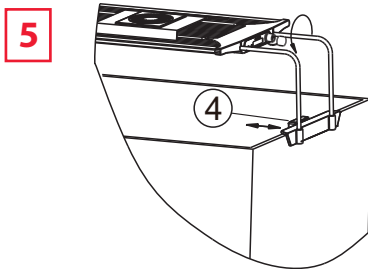
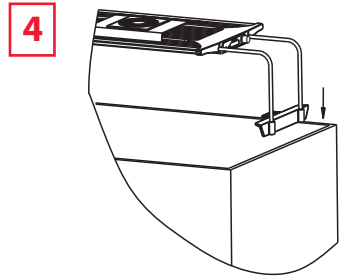
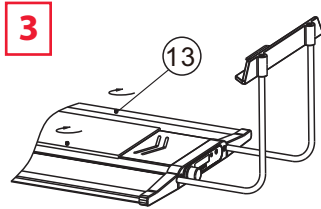
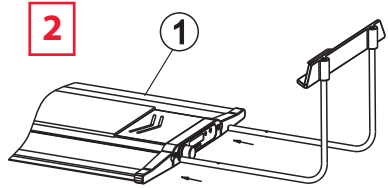
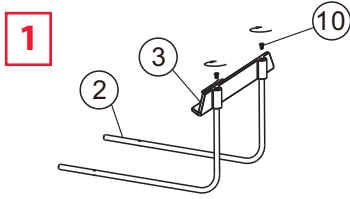

b. Aufhängung

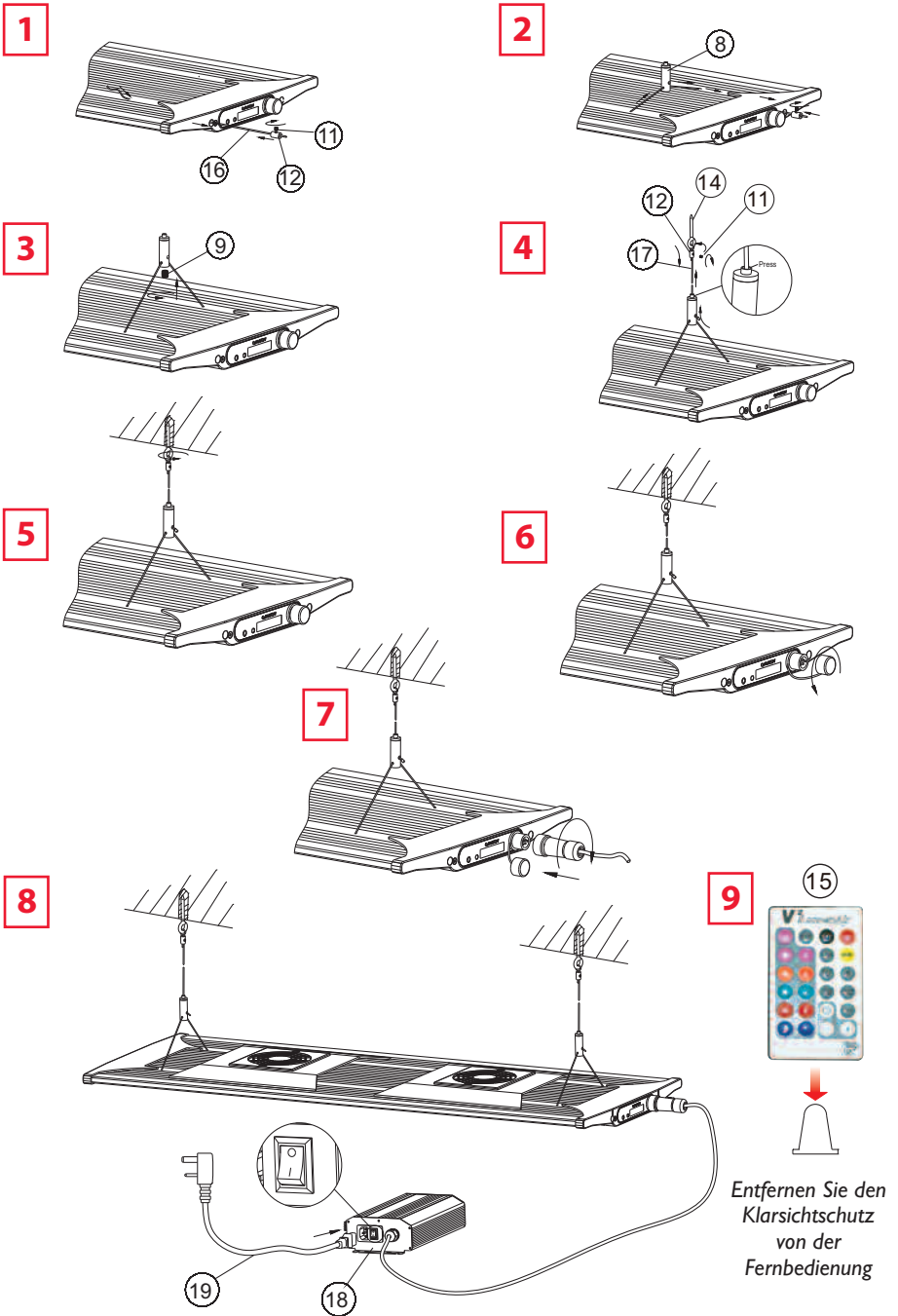

Display

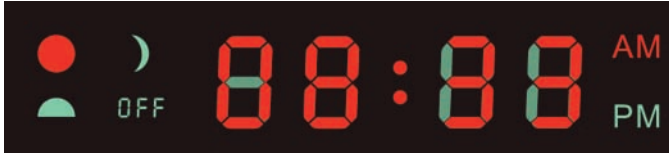

leuchtet in der Tageslichtphase



leuchtet bei den Effekten „Sonnenaufgang“ und „Sonnenuntergang“



leuchtet bei den Effekten „Dämmerung“ und „Mondlicht“



















leuchtet, wenn die Beleuchtung ausgeschaltet ist

- Im Laufmodus zeigt das Display die Uhrzeit im 24- oder 12-Stunden-Format an.
- Wenn Sie die Phasen einstellen, stellt die erste Ziffer den eingestellten Zeitraum dar.
„1“ steht für Dämmerung
„2“ für Sonnenaufgang
„3“ für Tageslicht
„4“ für Sonnenuntergang
„5“ für Mondlicht
- Der Buchstabe stellt den eingestellten LED-Kanal dar.
„A“ ist der weiße
„b“ der blaue
„C“ der gemischtfarbige Kanal
- Die letzten beiden Ziffern geben die Helligkeit des jeweiligen Kanals im Bereich von „00“ bis „32“ an.
- Im Modus „Gewitter“ zeigt das Display die Häufigkeit der Blitzschläge im Bereich von „1“ bis „8“ an.
- Im Modus „Farbdemo“ zeigt das Display die Häufigkeit der Farbänderungen im Bereich von „Co01“ bis „Co12“ an.
- Wenn im Display  angezeigt wird, bedeutet dies, dass sich diese Vorrichtung im Slave-Modus für ein anderes Steuerelement befindet.

Bedienungsanleitung

Schnellstart

1. Vergewissern Sie sich, dass der Klarsichtschutz der Batterie unten am Controller entfernt ist (siehe Seite 22).
2. Um die Fernbedienung zu verwenden, richten Sie diese auf den Infrarotsensor am Kabeingang zur Beleuchtungseinheit.
3. Drücken Sie auf  um die Uhrzeit einzustellen. Drücken Sie einmal, um die Stunden, und zweimal, um die Minuten einzustellen. Mit   können Sie den Wert erhöhen/verringern. Die Uhrzeiteinstellung wird automatisch nach zehn Sekunden gespeichert. Sie können auch auf  drücken, um zu Ihrem eingestellten Programm mit der aktualisierten Uhrzeit zurückzukehren.
4. Drücken Sie auf  um zwischen dem 24-Stunden- und dem 12-Stunden-Format zu wechseln.
5. Drücken Sie auf  um das eingestellte Programm auszuführen. (Weitere Informationen zu den Werkseinstellungen des Standardprogramms finden Sie auf Seite 26).
6. Drücken Sie auf  um die Beleuchtung auszuschalten.
7. Drücken Sie auf  um den Modus „Gewitter“ einzustellen. Mit   können Sie den Wert für die Blitzschläge erhöhen/verringern.
Drücken Sie  um zum eingestellten Programm zurückzukehren.
8. Drücken Sie auf  um den Modus „Farbdemo“ einzustellen. Mit   können Sie die Geschwindigkeit für die Farbübergänge erhöhen/verringern. Mit den niedrigsten Einstellungen können Sie einen Wolkeneffekt erzielen. Drücken Sie  um zum eingestellten Programm zurückzukehren.
9. Drücken Sie wiederholt auf  um im Display die Temperatur der Beleuchtungseinheit in °C oder °F und die Leistung in Watt anzuzeigen.
10. Drücken Sie auf  um die Einheit in den Slave-Modus zu einem anderen Controller zu schalten (wird separat angeboten).



Programmierung

1. Drücken Sie auf  um die Anfangszeit für Ihre Fotoperiode einzustellen. Drücken Sie einmal, um die Stunden, und zweimal, um die Minuten einzustellen. Mit   können Sie den Wert erhöhen/verringern.
2. Drücken Sie  um die Einstellungen zu speichern.
3. Drücken Sie auf  um die Dauer für die **Dämmerungsphase** einzustellen. Drücken Sie einmal, um die Stunden, und zweimal, um die Minuten einzustellen. Mit   können Sie den Wert erhöhen/verringern.
4. Drücken Sie wiederholt auf  um zwischen dem weißen, blauen und gemischtfarbigen Kanal zu wechseln. Sie können die Helligkeit für jeden Kanal über   festlegen, um den gewünschten Dämmerungseffekt zu erzielen.
5. Drücken Sie  um die Einstellungen zu speichern.
6. Drücken Sie auf  um die Dauer für die **Sonnenaufgangsphase** einzustellen. Drücken Sie einmal, um die Stunden, und zweimal, um die Minuten einzustellen. Mit   können Sie den Wert erhöhen/verringern.
7. Drücken Sie wiederholt auf  um zwischen dem weißen, blauen und gemischtfarbigen Kanal zu wechseln. Sie können die Helligkeit für jeden Kanal über   festlegen, um den gewünschten Sonnenaufgangseffekt zu erzielen.
8. Drücken Sie  um die Einstellungen zu speichern.
9. Drücken Sie auf  um die Dauer für die **Tageslichtphase** einzustellen. Drücken Sie einmal, um die Stunden, und zweimal, um die Minuten einzustellen. Mit   können Sie den Wert erhöhen/verringern.
10. Drücken Sie wiederholt auf  um zwischen dem weißen, blauen und gemischtfarbigen Kanal zu wechseln. Sie können die Helligkeit für jeden Kanal über   festlegen, um den gewünschten Tageslichteffekt zu erzielen.
11. Drücken Sie  um die Einstellungen zu speichern.
12. Drücken Sie auf  um die Dauer für die **Sonnenuntergangsphase** einzustellen. Drücken Sie einmal, um die Stunden, und zweimal, um die Minuten einzustellen. Mit   können Sie den Wert erhöhen/verringern.
13. Drücken Sie wiederholt auf  um zwischen dem weißen, blauen und gemischtfarbigen Kanal zu wechseln. Sie können die Helligkeit für jeden Kanal über   festlegen, um den gewünschten Sonnenuntergangseffekt zu erzielen.
14. Drücken Sie  um die Einstellungen zu speichern.
15. Drücken Sie auf  um die Dauer für die **Mondlichtphase** einzustellen. Drücken Sie einmal, um die Stunden, und zweimal, um die Minuten einzustellen. Mit   können Sie den Wert erhöhen/verringern.
16. Drücken Sie wiederholt auf  um zwischen dem weißen, blauen und gemischtfarbigen Kanal zu wechseln. Sie können die Helligkeit für jeden Kanal über   festlegen, um den gewünschten Mondlichteffekt zu erzielen.
17. Drücken Sie  um die Einstellungen zu speichern.

Nachdem Sie Ihr Programm eingestellt haben, können Sie eine Demo Ihrer Einstellungen aufrufen, indem Sie auf drücken. Hierbei läuft die 24-Stunden-Fotoperiode in etwas über zwei Minuten ab, wobei eine Sekunde jeweils zehn Minuten des Zyklus entspricht.

HINWEIS: Wenn die Gesamtanzahl der Stunden Ihrer Fotoperiode kleiner als 24 Stunden ist, wird die Beleuchtung nach der Mondlichtphase ausgeschaltet und zum Zeitpunkt der Anfangszeit wieder eingeschaltet. Wenn die Gesamtdauer 24 Stunden überschreitet, wird nach Ablauf von 24 Stunden der entsprechende Teil außer Kraft gesetzt und zum Zeitpunkt der Anfangszeit durch die Dämmerungsphase ersetzt.

Empfehlungen für die Tageslichtphase

Die nachfolgenden Vorschläge dienen nur als Orientierungshilfe. Korallen können in tieferen Aquarien gehalten werden. Sie müssen sicherstellen, dass die Korallen korrekt beleuchtet werden. Wenn Sie sich nicht sicher sind, wenden Sie sich an den Fachhandel.

Kleinpölpige Steinkoralle

Alle Kanäle 100 % (32) für Becken mit einer Tiefe von über 60 cm

Alle Kanäle 90% (29) für Becken mit einer Tiefe von 45 cm

Alle Kanäle 75% (24) für Becken mit einer Tiefe von 30cm

Großpölpige Steinkoralle

Alle Kanäle 75% (24) für Becken mit einer Tiefe von 60cm

Alle Kanäle 65% (20) für Becken mit einer Tiefe von 45 cm

Alle Kanäle 55% (17) für Becken mit einer Tiefe von 30cm

Weichkoralle







Alle Kanäle 65% (20) für Becken mit einer Tiefe von 60cm

Alle Kanäle 55% (17) für Becken mit einer Tiefe von 45 cm

Alle Kanäle 45% (14) für Becken mit einer Tiefe von 30cm

Werkseinstellungen

Um die Werkseinstellungen wiederherzustellen, drücken Sie zuerst auf  und anschließend auf .



Funktionen	Knöpfe	Anfangszeit/ Dauer	Helligkeit einstellen		
			Weiß	Blau	Gemischtfarbig
Anfangszeit für die Beleuchtung		05:00 (Anfangszeit)	-	-	-
Dauer und Farbe für die Dämmerungsphase		02:00	1A 01	1B 01	1C 01
Dauer und Farbe für die Sonnenaufgangsphase		01:00	2A 10	2B 05	2C 28
Dauer und Farbe für die Tageslichtphase		10:00	3A 28	3B 28	3C 28
Dauer und Farbe für die Sonnenuntergangsphase		02:00	4A 15	4B 10	4C 30
Dauer und Farbe für die Mondlichtphase		03:00	5A 02	5B 10	5C 02



Überhitzungsschutz

Das Gebläse wird automatisch eingeschaltet, wenn die gesamte Beleuchtung aktiv ist oder die Temperatur der Beleuchtung 38 °C überschreitet. Das Gebläse wird automatisch ausgeschaltet, wenn die Temperatur der Beleuchtung um die 34 °C beträgt. Bei Überhitzung der Einheit (ab ca. 60 °C) wird die Beleuchtung ausgeschaltet und im Display **Err** angezeigt.

Betrieb der blauen LED- Zierblende

Um die blaue LED- Zierblende zu steuern, richten Sie die Fernbedienung auf den Infrarotsensor der Beleuchtungseinheit gegenüber vom Kabeleingang.







Drücken Sie auf   um die Helligkeit der blauen LED- Zierblende zu erhöhen oder zu verringern.

Drücken Sie auf  um sie auszuschalten und auf  um sie wieder einzuschalten.



Wenn Sie auf  drücken, wird die Helligkeit der Zierblende automatisch wechselweise erhöht und verringert, um einen Pulsierungseffekt zu erzielen.

Problembehandlung

Die Beleuchtung funktioniert nicht

1. Stellen Sie sicher, dass sie an die Stromversorgung angeschlossen ist. Ist dies nicht der Fall, schließen Sie diese an.
2. Überprüfen Sie, ob die Beleuchtung im Slave-Modus oder ausgeschaltet ist. (Im Display wird **In** oder **OFF** angezeigt.) Ist dies der Fall, drücken Sie  um zum Laufmodus zurückzukehren.
3. Überprüfen Sie, ob die Helligkeit auf „0“ gesetzt ist. Drücken Sie auf  oder  oder  oder  oder  um die Helligkeit einzustellen
4. Stellen Sie sicher, dass die Beleuchtung nicht aufgrund einer Programmeinstellung ausgeschaltet ist. Auf Seite 25 finden Sie Informationen zum Festlegen von Programmeinstellungen.

Die Beleuchtung ist immer eingeschaltet

1. Überprüfen Sie, ob die gesamte Fotoperiode eine Dauer von über 24 Stunden hat. Auf Seite 25 finden Sie Informationen zum Festlegen von Programmeinstellungen.
2. Vergewissern Sie sich, dass die Uhrzeit korrekt eingestellt ist. Drücken Sie auf  und   um die Uhrzeit einzustellen.

Im Display wird **Err** angezeigt

1. Überprüfen Sie, ob die Oberseite der Einheit und das Gebläse blockiert oder verdeckt sind. Ist dies der Fall, entfernen Sie Staub/Ablagerungen, um eine gute Luftzirkulation sicherzustellen.
2. Überprüfen Sie, ob das Gebläse in Betrieb ist. Ist dies nicht der Fall, wenden Sie sich an Tropical Marine Centre oder an den Fachhandel, um ein Ersatzgebläse zu beziehen.

Die Fernbedienung funktioniert nicht

1. Überprüfen Sie, ob die Beleuchtung im Slave-Modus oder ausgeschaltet ist. (Im Display wird **In** oder **OFF** angezeigt.) Ist dies der Fall, drücken Sie  um zum Laufmodus zurückzukehren.
2. Stellen Sie sicher, dass die Fernbedienung auf den korrekten Infrarotsensor der Beleuchtungseinheit gerichtet ist, um den gewünschten Vorgang auszuführen. Lesen Sie hierzu Seite 24.
3. Überprüfen Sie die Batterie. Diese kann einfach durch eine neue CR2032-Knopfzelle ausgetauscht werden.

Das Licht blinkt

1. Stellen Sie sicher, dass die Beleuchtung nicht auf „Gewitter“ oder „Farbdemo“ eingestellt ist. Drücken Sie  um zum Laufmodus zurückzukehren.

V²iLumenAir 900

INSTRUCCIONES DE INSTALACIÓN Y USO

Importante información sobre seguridad – Lea detenidamente

- **Precaución:** No utilice ninguna otra unidad de suministro eléctrico (PSU) con una unidad de lámparas V²iLumenAir ya que la lámpara puede no funcionar y puede ocasionarse un daño irreparable a la misma. Si la PSU que se suministra con la unidad necesita ser repuesta, obtenga una PSU V²iLumenAir original a través de un de los distribuidores locales de Tropical Marine Centre.



- Aísle siempre la PSU de la toma de suministro eléctrico antes de instalar o realizar obras de mantenimiento.
- **Precaución:** No ponga este dispositivo en funcionamiento si alguna pieza tiene un cable dañado, si funciona mal o si se ha caído, ha sido sumergida en agua o ha sufrido otro tipo de daños. Si el cable exterior de la unidad está dañado, debe cambiarlo por un cable disponible exclusivamente a través del fabricante o de su distribuidor
- La unidad está diseñada para su uso en interior y no es adecuada para aplicaciones de exterior.
- **Precaución:** Asegúrese de que la unidad de lámparas V²iLumenAir está correctamente instalada sobre el depósito antes de ponerla en funcionamiento.
- **Precaución:** Deje siempre un lazo de goteo en el cable de suministro CC a la unidad de lámparas V²iLumenAir para impedir que el agua deslice por el cable y alcance la PSU (ver el dibujo a continuación).
- **Precaución:** No salpique ni sumerja la lámpara o la fuente de alimentación.
- **Precaución:** No obstruya los ventiladores de refrigeración de ninguna manera.
- Para prolongar la vida útil de su lámpara asegúrese de mantenerla limpia de polvo, sal y otros desechos.
- Deshágase de esta unidad de manera responsable. Consulte con las autoridades locales para saber cómo deshacerse de ella.

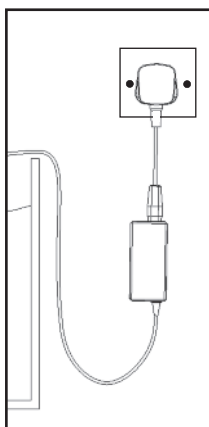

Especificación del Producto

Modelo: V²iLumenAir 900

Dimensiones: 690 x 260 x 24 mm

Adecuada para estanques de 730 a 1200 mm de largo x 300 a 880 mm de ancho

Alimentación: 100 a 240 V, 50/60 Hz

Potencia total: 179 W

Flujo luminoso total: 9000 lm

Lista de piezas

Verifique que cuenta con todas las piezas que se indican a continuación.

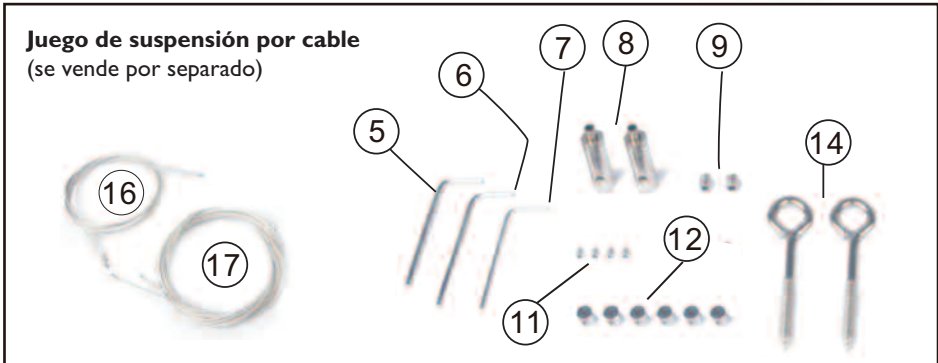
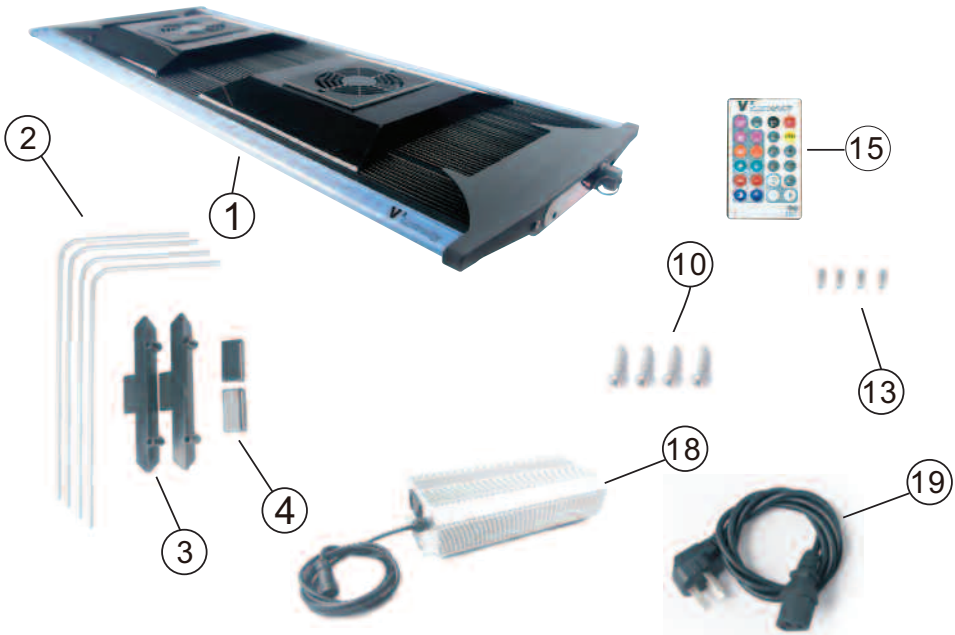

Instalación

Para instalar la V²iLumenAir se puede utilizar el juego de montaje para acuarios (suministrado) o un juego de suspensión por cable (se vende por separado).

a. Montaje en acuario

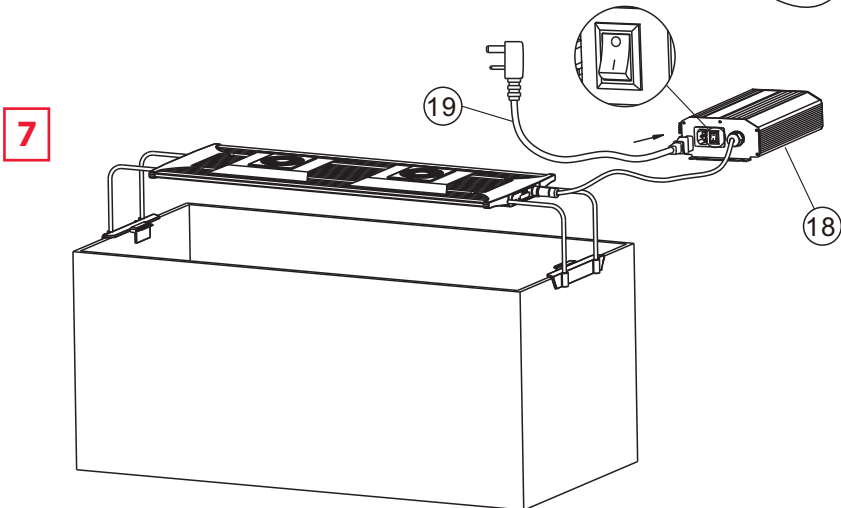
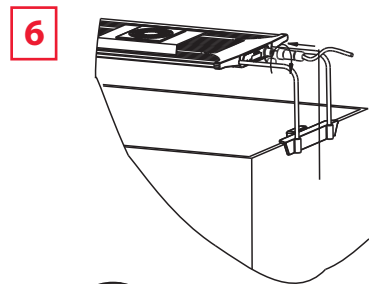
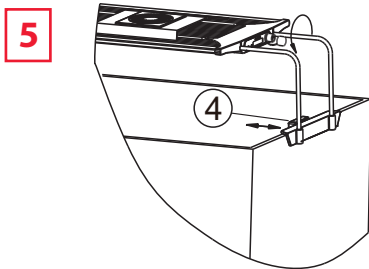
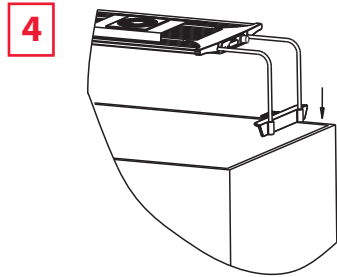
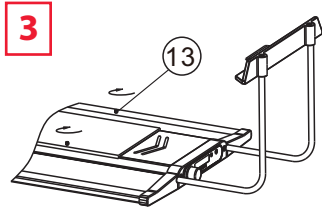
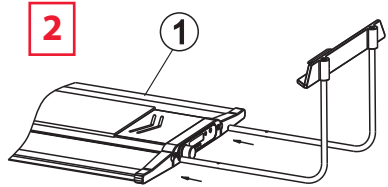
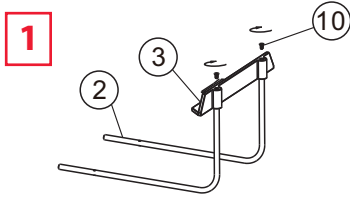

b. Suspensión mediante cable

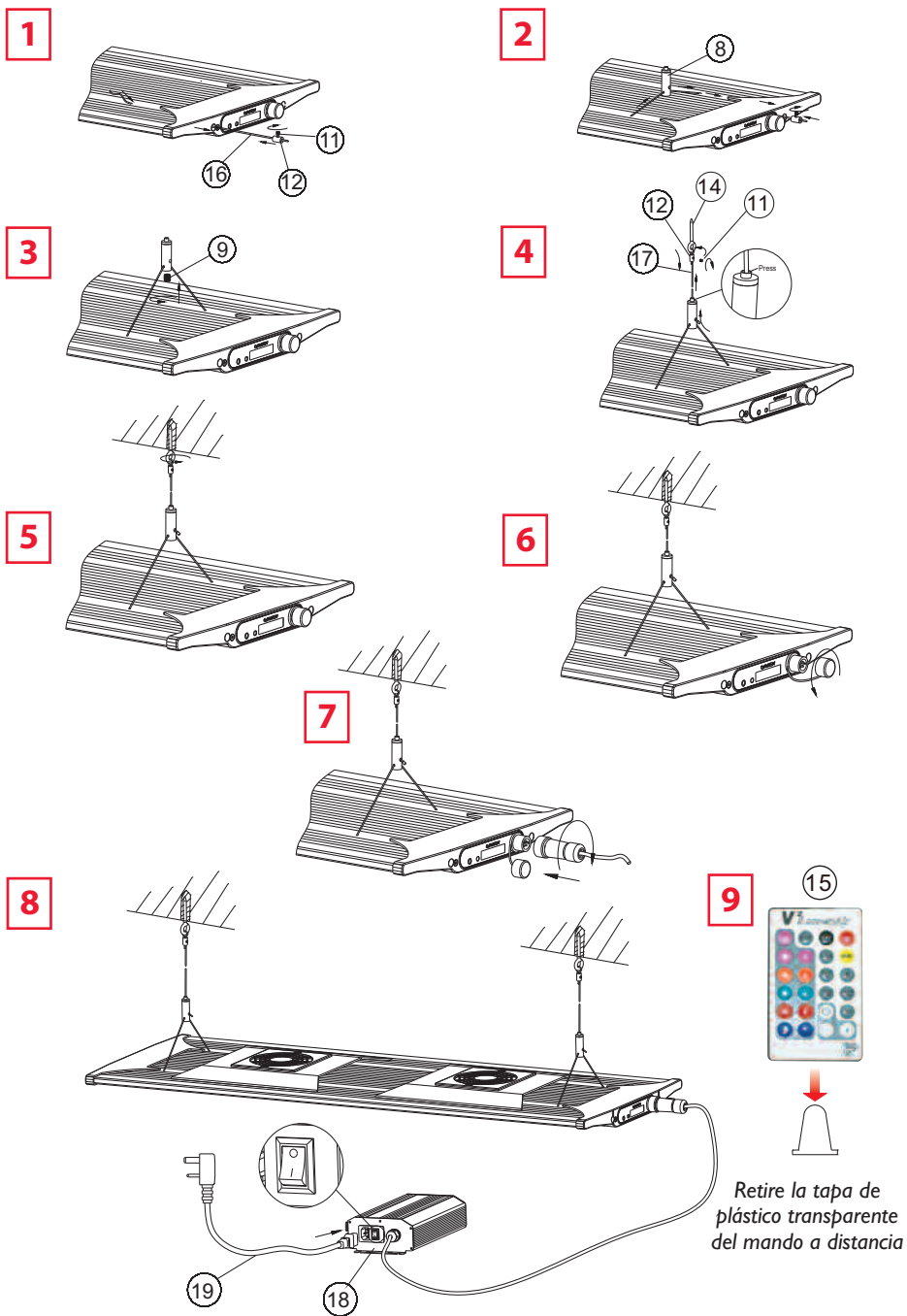

Pantalla de Visualización

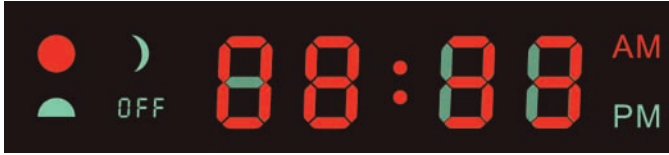

muestra cuando la lámpara se encuentra en la fase diurna.



muestra cuando la lámpara se encuentra en la fase de la salida o la puesta del sol.



muestra cuando la lámpara se encuentra en la fase del amanecer o de luz lunar.



muestra cuando la lámpara está apagada.













- En el modo de ejecución, la pantalla muestra la hora en formato de 24 o de 12 horas.
- Al definir las fases, el primer dígito representa el período de tiempo que está ajustando.
 - '1' indica el amanecer
 - '2' indica la salida del sol,
 - '3' indica el día
 - '4' indica la puesta del sol
 - '5' indica la luz lunar.
- La letra representa el canal de LED que está ajustando.
 - 'A' es el canal blanco,
 - 'b' el azul
 - 'C' la mezcla de colores.
- Los últimos dos dígitos indican el nivel de brillo del canal desde '00' a '32'.
- En el modo tormenta la pantalla indica la frecuencia de los rayos desde '1' a '8'.
- En el modo de demostración de color la pantalla indica la frecuencia de las variaciones del color desde 'Co01' a 'Co12'.
- Cuando la pantalla muestra  significa que esta lámpara trabaja como esclava de otra unidad de control.

Instrucciones de Utilización

Inicio rápido







































1. Verifique que la tapa de plástico transparente para protección de la batería fue desmontada de la parte inferior del mando (véase la página 31).
2. Para utilizar el mando a distancia, apunte hacia el sensor de infrarrojos ubicado en la entrada del cable de la lámpara.
3. Pulse  para poner en hora el reloj. Pulse una vez para ajustar la hora y dos veces para ajustar los minutos.

Utilice   para aumentar o disminuir el valor. El ajuste de la hora se guardará automáticamente después de diez segundos. Si lo desea, pulse  para volver al programa establecido pero con la hora actualizada.

4. Pulse  para escoger el formato de la hora entre 24 horas y 12 horas.
5. Pulse  para ejecutar el programa definido (vea los detalles del programa predefinido en fábrica en la página 35).
6. Pulse  para apagar la lámpara.
7. Pulse  para entrar en el modo tormenta. Utilice   para cambiar la frecuencia de los rayos. Pulse  para volver al programa ajustado.
8. Pulse  para entrar en una demostración de colores. Utilice   para cambiar la velocidad de las transiciones. Los valores más lentos pueden ser empleados para simular nubes que pasan sobre el estanque. Pulse  para volver al programa ajustado.
9. Pulse repetidamente  para cambiar la pantalla con la finalidad de visualizar la temperatura de la lámpara (en °C o °F) y la potencia eléctrica (en vatios) consumida por la unidad.
10. Pulse  para que el equipo dependa de otro mando (se vende por separado).



Programación

1. Pulse  para establecer la hora de inicio del cambio de iluminación (fotoperíodo). Pulse una vez para ajustar la hora y dos veces para ajustar los minutos. Utilice   para aumentar o disminuir el valor.
2. Pulse  para guardar los ajustes realizados.
3. Pulse  para definir la duración de la fase del **amanecer**. Pulse una vez para ajustar la hora y dos veces para ajustar los minutos. Utilice   para aumentar o disminuir el valor.
4. Pulse repetidamente  para escoger entre los canales blanco, azul o mezcla de colores. Pulse   para ajustar el brillo de cada canal y crear su efecto de amanecer preferido.
5. Pulse  para guardar los ajustes realizados.
6. Pulse  para definir la duración de la fase de la **salida del sol**. Pulse una vez para ajustar la hora y dos veces para ajustar los minutos. Utilice   para aumentar o disminuir el valor.
7. Pulse repetidamente  para escoger entre los canales blanco, azul o mezcla de colores. Pulse   para ajustar el brillo de cada canal y crear su efecto de salida del sol preferido.
8. Pulse  para guardar los ajustes realizados.
9. Pulse  para definir la duración de la fase **diurna**. Pulse una vez para ajustar la hora y dos veces para ajustar los minutos. Utilice   para aumentar o disminuir el valor.
10. Pulse repetidamente  para escoger entre los canales blanco, azul o mezcla de colores. Pulse   para ajustar el brillo de cada canal y crear su efecto de luz diurna preferido.
11. Pulse  para guardar los ajustes realizados.
12. Pulse  para definir la duración de la fase de la **puesta del sol**. Pulse una vez para ajustar la hora y dos veces para ajustar los minutos. Utilice   para aumentar o disminuir el valor.
13. Pulse repetidamente  para escoger entre los canales blanco, azul o mezcla de colores. Pulse   para ajustar el brillo de cada canal y crear su efecto de puesta del sol preferido.
14. Pulse  para guardar los ajustes realizados.
15. Pulse  para definir la duración de la fase de **luz lunar**. Pulse una vez para ajustar la hora y dos veces para ajustar los minutos. Utilice   para aumentar o disminuir el valor.
16. Pulse repetidamente  para escoger entre los canales blanco, azul o mezcla de colores. Pulse   para ajustar el brillo de cada canal y crear su efecto de luz lunar preferido.
17. Pulse  para guardar los ajustes realizados.



Una vez configurado el programa, pulse  para una demostración con los ajustes escogidos. Esta demostración ejecutará un fotoperíodo de 24 horas en poco más de 2 minutos (1 segundo equivale a 10 minutos del ciclo).

NOTA: Si la cantidad total de horas de su fotoperíodo es menor de 24, la lámpara se apagará después de la fase de luz lunar y se encenderá nuevamente a la hora de inicio. Si la cantidad total de horas es mayor de 24, el tiempo que exceda las 24 horas será ignorado por el amanecer a la hora de inicio programada.

Recomendaciones para la fase de luz diurna

Las sugerencias indicadas a continuación solo sirven a modo de guía. Los corales pueden estar situados en acuarios más profundos. Tenga en cuenta que depende de usted verificar que sus corales reciben la cantidad correcta de luz. Consulte a su tienda local de peces si no está seguro.

Coral duro de pólipos cortos

Todos los canales 100 % (32) para estanques de más de 60 cm de profundidad

Todos los canales 90 % (29) para estanques de 45cm de profundidad

Todos los canales 75 % (24) para estanques de 30 cm de profundidad

Coral duro de pólipos largos

Todos los canales 75 % (24) para estanques de 60 cm de profundidad

Todos los canales 65 % (20) para estanques de 45 cm de profundidad

Todos los canales 55 % (17) para estanques de 30 cm de profundidad



Coral blando







Todos los canales 65 % (20) para estanques de 60 cm de profundidad

Todos los canales 55 % (17) para estanques de 45 cm de profundidad

Todos los canales 45 % (14) para estanques de 30 cm de profundidad

Configuración de fábrica

Para restablecer la configuración de fábrica pulse  y luego .



Funciones	Botones	Hora de inicio/ duración	Ajuste de brillo		
			Blanco	Azul	Mezcla de Colores
Hora de encendido de la lámpara		05:00 (Hora de encendido)	-	-	-
Duración y color del amanecer		02:00	1A 01	16 01	1C 01
Duración y color de la salida del sol		01:00	2A 10	26 05	2C 28
Duración y color de la luz diurna		10:00	3A 28	36 28	3C 28
Duración y color de la puesta del sol		02:00	4A 15	46 10	4C 30
Duración y color de la luz lunar		03:00	5A 02	56 10	5C 02

Protección contra el exceso de temperatura

Los ventiladores inteligentes arrancarán cuando las luces estén encendidas a pleno o la temperatura de la lámpara sea superior a 38° C (100° F) y se detendrán cuando la lámpara se enfríe a aproximadamente 34° C (93° F). Si la unidad se calienta demasiado, alrededor de 60° C (140° F), la lámpara se apagará y la pantalla mostrará .

Utilización de la tira de luz de LED azul

Para controlar la luz de la tira de LED azul apunte el mando a distancia hacia el sensor de infrarrojos de la lámpara, ubicado en el extremo opuesto a la entrada del cable.









Pulse   para aumentar o disminuir el brillo de la tira de LED azul.

Pulse  para apagarla y  para volver a encenderla.



Si pulsa  el brillo de la tira disminuirá y aumentará automáticamente creando un efecto pulsante.

Solución de problemas

La lámpara no funciona

1. Verifique que esté conectada a la alimentación. Si no es así, conéctela.
2. Verifique si la lámpara está en el modo esclavo o apagado (la pantalla muestra  u ). Si es así, pulse  para volver al modo de funcionamiento normal.
3. Verifique si el brillo está ajustado en '0'. Pulse  o  o  o  o  para ajustar el nivel del brillo.
4. Verifique si la lámpara no debería estar apagada, de acuerdo a los ajustes de su programa. Para modificar el programa, consulte la página 34.



La lámpara está siempre encendida

1. Verifique si la duración del fotoperíodo es mayor de 24 horas. Para modificar el programa, consulte la página 34.
2. Verifique si la hora está bien ajustada. Pulse  y   para ajustar la hora.

La pantalla muestra

1. Verifique si la parte superior de la unidad y los ventiladores están obstruidos o cubiertos con algún objeto. En caso afirmativo, elimine el polvo y la suciedad para asegurar un buen flujo de aire.
2. Verifique que los ventiladores funcionen. En caso contrario, consulte a Tropical Marine Centre o a su distribuidor local para obtener ventiladores de repuesto.

El mando a distancia no funciona

1. Verifique si la lámpara está en el modo esclavo o apagado (la pantalla muestra  u ). Si es así, pulse  para volver al modo de funcionamiento normal.
2. Verifique que el mando a distancia apunta al sensor de infrarrojos correcto de la lámpara para la acción que intenta llevar a cabo. Consulte la página 33.
3. Revise la batería. La batería, tipo moneda CR2032, se reemplaza fácilmente.

La lámpara emite destellos

1. Verifique que la lámpara no esté en el modo tormenta o de demostración. Pulse  para volver al modo de funcionamiento normal.

V²iLumenAir 900

INSTRUÇÕES DE INSTALAÇÃO E UTILIZAÇÃO

Informações importantes sobre segurança – Por favor leia com atenção

- **Atenção:** Não utilizar qualquer outra unidade (fonte) de alimentação com uma unidade de iluminação V²iLumenAir uma vez que a unidade de iluminação poderá não funcionar e isto poderá causar danos irreparáveis na mesma. Se a unidade (fonte) de alimentação fornecida tiver de ser substituída, por favor adquira uma unidade (fonte) de alimentação V²iLumenAir genuína fornecida por um revendedor local do Tropical Marine Centre.
- Isolar sempre a unidade (fonte) de alimentação da corrente antes de instalar ou realizar qualquer manutenção.
- **Atenção:** Não ligar este aparelho se alguma parte do fio ou da ficha estiver danificada, se o aparelho estiver a funcionar mal ou se tiver caído, sido submerso na água ou tiver de qualquer outra forma sido danificado. Se o fio exterior desta unidade danificar-se, este deve ser substituído por um fio, que só pode ser exclusivamente fornecido pelos dos fabricantes ou pelo ser agente serviço.
- Esta unidade foi concebida para utilização dentro de casa, não sendo própria para quaisquer aplicações no exterior.
- **Atenção:** Certifique-se de que a unidade de iluminação V²iLumenAir está instalada de forma segura por cima do aquário/reservatório antes de ser posta em funcionamento.
- **Atenção:** Deixar sempre uma parte do fio do cabo de alimentação da unidade de iluminação V²iLumenAir pendurada a um nível inferior ao da tomada de modo a impedir que a água escorra ao longo do cabo e chegue até à unidade (fonte) de alimentação (ver ilustração a seguir).
- **Atenção:** Não salpicar nem submergir a lâmpada ou a fonte de alimentação elétrica.
- **Atenção:** Não obstruir as ventoinhas de arrefecimento de nenhuma maneira.
- Para prolongar a vida útil da sua unidade da luz, certifique-se de que não tem pó, sal e outros resíduos.
- Quando deitar esta unidade para o lixo, queira por favor respeitar as normas ambientais. Informe-se junto da sua autarquia sobre a forma de eliminar este tipo de resíduos.

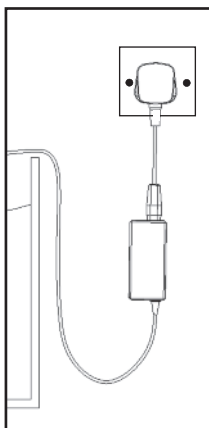

Especificações do Produto

Modelo: V²iLumenAir 900

Dimensões: 690 x 260 x 24 mm

Adequado para tanques com 730-1200 mm de comprimento x 300-880 mm de largura

Entrada: 100-240 V 50/60 Hz

Potência total: 179 W

Fluxo luminoso total: 9000 lm

Lista de Peças

Certifique-se de que tem todas as peças apresentadas abaixo.

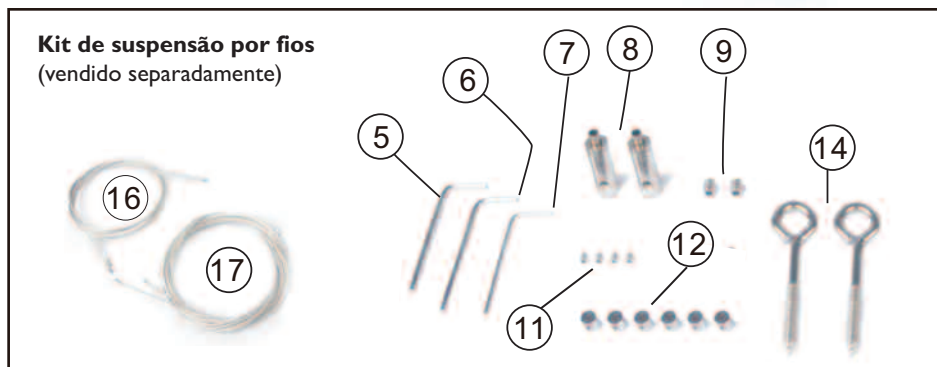

Instalação

O V²iLumenAir pode ser montado através do kit de montagem no tanque (fornecido) ou do kit de suspensão por fios (vendido separadamente).

a. Montagem no tanque

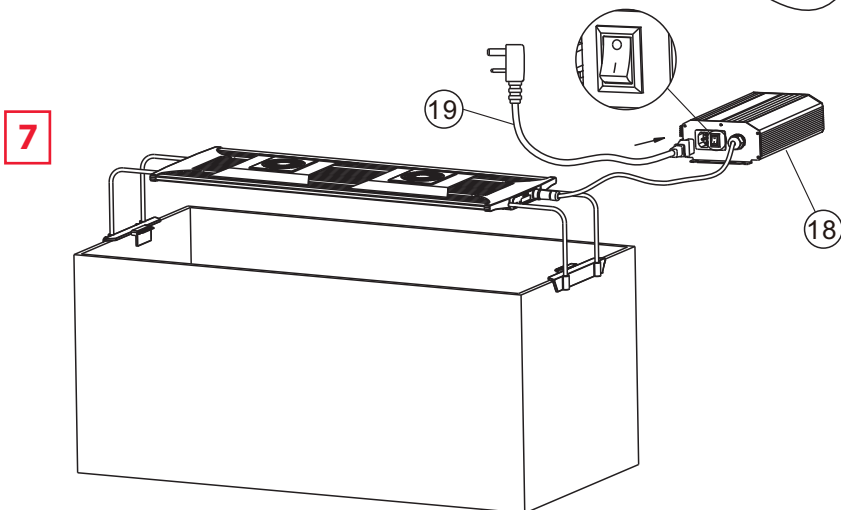
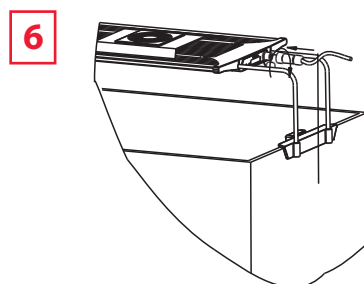
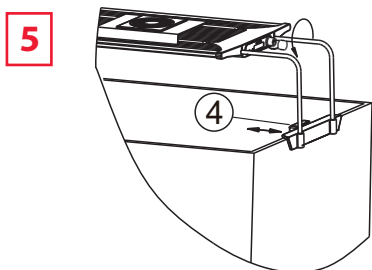
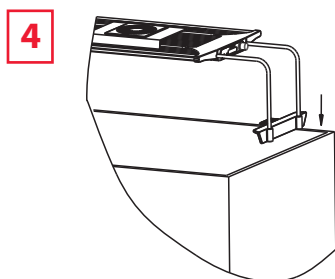
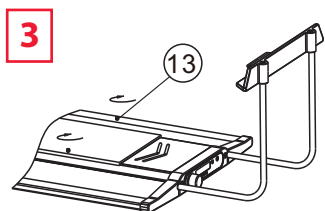
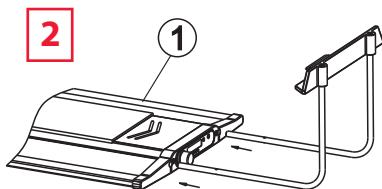
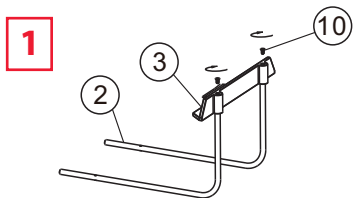



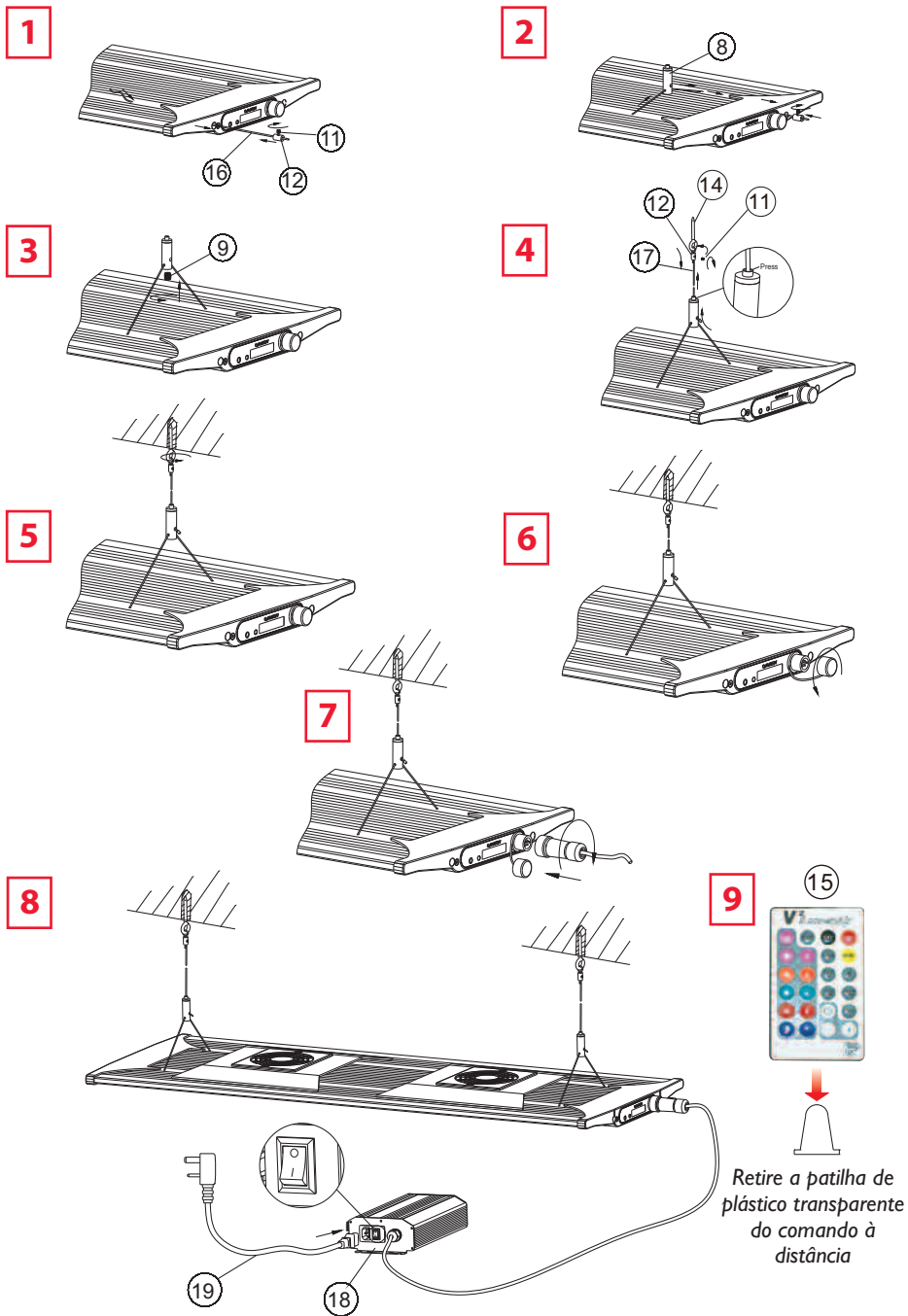

b. Suspensão por fios



Ecrã do visor



-  mostra quando está na fase de dia.
-  mostra quando está na fase de nascer do sol ou pôr do sol.
-  mostra quando está na fase de amanhecer ou luar.
-  mostra quando a luz está desligada.

- Em modo de execução, o visor mostra as horas no formato de relógio de 24 ou 12 horas.

- Ao configurar as fases, o primeiro dígito representa o período de tempo que está a configurar.

- '1' indica amanhecer
- '2' indica nascer do sol
- '3' indica dia
- '4' indica pôr do sol
- '5' indica luar

- A letra representa qual das calhas de LEDs está a configurar:

- 'A' é a calha branca
- 'b' é a azul
- 'C' é a mistura de cores

- Os últimos dois dígitos indicam o nível de brilho da calha de '00' a '32'.

















- Em modo de tempestade, o visor indica a frequência de raios de '1' a '8'.

- Em modo de demonstração de cores, o visor indica a frequência de variação de cores de 'Co01' a 'Co12'.

- Se o visor apresentar  significa que este acessório é um slave de outra unidade de comando.

Instruções de funcionamento

Início rápido

1. Certifique-se de que a patilha de proteção da pilha de plástico transparente é retirada do fundo do controlador (ver página 40).
2. Para utilizar o comando à distância, aponte-o para o sensor de infravermelhos na entrada do cabo para a unidade da luz.
3. Prima  para configurar o relógio. Prima uma vez para ajustar as horas e duas vezes para ajustar os minutos. Utilize   para ajustar para cima ou para baixo. A configuração das horas será automaticamente guardada após dez segundos ou pode premir  para voltar para o seu programa configurado pelo utilizador com as horas atualizadas.
4. Prima  para escolher entre o formato de relógio de 24 horas e 12 horas.
5. Prima  para executar o programa configurado (pormenores do programa configurado de fábrica na página 44)
6. Prima  para desligar a luz.
7. Prima  para entrar em modo de tempestade. Utilize   para alterar a frequência de raios. Prima  para voltar ao programa configurado.
8. Prima  para entrar numa demonstração de cores. Utilize   para alterar a velocidade das transições.
Nas configurações mais lentas, isto pode ser utilizado para simular nuvens a passar por cima. Prima  para voltar ao programa configurado.
9. Prima  repetidamente para o visor mostrar a temperatura da unidade da luz em °C e em °F e a potência elétrica que está a ser utilizada pela unidade da luz em Watts.
10. Prima  para tornar a unidade num slave de outro controlador (vendido separadamente).



Programação

1. Prima  para configurar a hora de início do seu fotoperíodo. Prima uma vez para ajustar as horas e duas vezes para ajustar os minutos. Utilize   para ajustar para cima ou para baixo.
2. Prima  para guardar as suas configurações.
3. Prima  para configurar a duração da fase de **amanhecer**. Prima uma vez para ajustar as horas e duas vezes para ajustar os minutos. Utilize   para ajustar para cima ou para baixo.
4. Prima  repetidamente para escolher entre as calhas branca, azul e de mistura de cores. Ajuste o brilho de cada calha utilizando   para criar o seu efeito de amanhecer preferido.
5. Prima  para guardar as suas configurações.
6. Prima  para configurar a duração da fase de **nascer do sol**. Prima uma vez para ajustar as horas e duas vezes para ajustar os minutos. Utilize   para ajustar para cima ou para baixo.
7. Prima  repetidamente para escolher entre as calhas branca, azul e de mistura de cores. Ajuste o brilho de cada calha utilizando   para criar o seu efeito de nascer do sol preferido.
8. Prima  para guardar as suas configurações.
9. Prima  para configurar a duração da fase de **dia**. Prima uma vez para ajustar as horas e duas vezes para ajustar os minutos. Utilize   para ajustar para cima ou para baixo.
10. Prima  repetidamente para escolher entre as calhas branca, azul e de mistura de cores. Ajuste o brilho de cada calha utilizando   para criar o seu efeito de dia preferido.
11. Prima  para guardar as suas configurações.
12. Prima  para configurar a duração da fase de **pôr do sol**. Prima uma vez para ajustar as horas e duas vezes para ajustar os minutos. Utilize   para ajustar para cima ou para baixo.
13. Prima  repetidamente para escolher entre as calhas branca, azul e de mistura de cores. Ajuste o brilho de cada calha utilizando   para criar o seu efeito de pôr do sol preferido.
14. Prima  para guardar as suas configurações.
15. Prima  para configurar a duração da fase de **luar**. Prima uma vez para ajustar as horas e duas vezes para ajustar os minutos. Utilize   para ajustar para cima ou para baixo.
16. Prima  repetidamente para escolher entre as calhas branca, azul e de mistura de cores. Ajuste o brilho de cada calha utilizando   para criar o seu efeito de luar preferido.
17. Prima  para guardar as suas configurações.

Depois de ter configurado o seu programa, pode ver uma demonstração das suas configurações premindo Isto executa o fotoperíodo de 24 horas em pouco mais de 2 minutos (1 segundo = 10 minutos do ciclo)

NOTA: Se o número total de horas do seu fotoperíodo for inferior a 24 horas, a luz apaga-se depois da fase de luar e acende-se novamente à hora de início. Se o total for superior a 24 horas, a parte que ultrapassa as 24 horas será substituída pelo amanhecer à hora de início configurada.

Recomendações para a luz diurna

As sugestões abaixo servem apenas para fins de orientação. Podem manter-se corais em aquários mais profundos. Note que compete-lhe a si assegurar que os seus corais recebem a quantidade de luz correta. Consulte a sua loja de aquarofilia local se tiver dúvidas.

Coral duro de pólipos pequenos

Todas as calhas 100% (32) para tanques com mais de 60 cm de profundidade

Todas as calhas 90% (29) para tanques de 45 cm de profundidade

Todas as calhas 75% (24) para tanques de 30 cm de profundidade

Coral duro de pólipos grandes

Todas as calhas 75% (24) para tanques de 60 cm de profundidade

Todas as calhas 65% (20) para tanques de 45 cm de profundidade

Todas as calhas 55% (17) para tanques de 30 cm de profundidade

Coral mole







Todas as calhas 65% (20) para tanques de 60 cm de profundidade

Todas as calhas 55% (17) para tanques de 45 cm de profundidade

Todas as calhas 45% (14) para tanques de 30 cm de profundidade

Configurações de fábrica

Para repor as configurações de fábrica, prima  em seguida 

Funções	Botões	Hora de início/ duração	Configurar o brilho		
			Branco	Azul	Mistura de Cores
Hora de início da luz		05:00 (Hora de início)	-	-	-
Duração e cor do amanhecer		02:00	1A 01	16 01	1C 01
Duração e cor do nascer do sol		01:00	2A 10	26 05	2C 28
Duração e cor do dia		10:00	3A 28	36 28	3C 28
Duração e cor do pôr do sol		02:00	4A 15	46 10	4C 30
Duração e cor do lunar		03:00	5A 02	56 10	5C 02

Proteção contra excesso de temperatura

As ventoinhas inteligentes começam a trabalhar quando as luzes estão todas acesas ou a temperatura da luz é superior a 38°C (100°F) e param quando arrefece para cerca de 34°C (93°F). Se a unidade ficar demasiado quente, a cerca de 60°C (140°F) a luz desliga-se e o visor apresenta .

Funcionamento da faixa de LEDs azuis

Para controlar a faixa de LEDs azuis, aponte o comando à distância para o sensor de infravermelhos na unidade da luz na extremidade oposta à entrada do cabo.









Prima   para alterar o brilho da faixa de LEDs azuis para cima e para baixo.

Prima  para a desligar e  para a ligar novamente.



Se premir  a faixa reduz e aumenta automaticamente a intensidade da luz de forma a criar um efeito pulsante.

Resolução de avarias

A luz não funciona

1. Verifique se está ligada à corrente. Se não estiver, ligue-a.
2. Verifique se a luz está em modo slave ou desligada (o visor mostra  ou ). Se estiver, prima  para voltar ao modo de execução.
3. Verifique se o brilho está configurado para '0'. Prima  ou  ou  ou  ou  para ajustar o nível de brilho.
4. Verifique se a luz não devia estar apagada de acordo com o seu programa configurado. Consulte a página 43 para ajustar o programa.



A luz está sempre acesa

1. Verifique se o fotoperíodo total é superior a 24 horas de duração. Consulte a página 43 para ajustar o programa.
2. Verifique se as horas estão corretamente configuradas. Prima  e   para configurar as horas.

O ecrã apresenta

1. Verifique se a parte superior da unidade e as ventoinhas estão bloqueadas ou tapadas. Se estiverem, retire o pó/resíduos para assegurar um bom fluxo de ar.
2. Verifique se as ventoinhas estão a funcionar. Se não estiverem, consulte o Tropical Marine Centre ou o seu vendedor local quanto a ventoinhas de substituição.

O comando à distância não funciona

1. Verifique se a luz está em modo slave ou desligada (o visor mostra  ou ). Se estiver, prima  para voltar ao modo de execução.
2. Verifique se o comando à distância está a apontar para o sensor de infravermelhos correto na unidade da luz para a operação que está a tentar fazer. Consulte a página 42.
3. Verifique a pilha. Esta pode ser facilmente substituída por uma pilha tipo moeda CR2032.



A luz está a piscar

1. Certifique-se de que a luz não está em modo de tempestade ou demonstração. Prima  para voltar ao modo de execução.

V²iLumenAir 900

ISTRUZIONI PER L'INSTALLAZIONE E L'USO

Informazioni importanti per la sicurezza – Leggere attentamente

- **Attenzione:** Utilizzare solo l'alimentatore fornito in dotazione con la lampada V²iLumenAir per evitare anomalie di funzionamento o danni irreparabili alla lampada stessa. Se è necessario sostituire il PSU in dotazione con la lampada, rivolgersi a un rivenditore locale Tropical Marine Centre per ottenere un alimentatore V²iLumenAir originale. 
- Prima di installare la lampada V²iLumenAir o eseguire interventi di manutenzione, isolare sempre l'alimentatore dalla rete elettrica.
- **Attenzione:** Non utilizzare l'apparecchio se presenta danni al cavo/alla spina o un funzionamento anomalo oppure in caso di caduta a terra, immersione in acqua o altro tipo di danni. Se il filo elettrico esterno dell'unità è danneggiato, si consiglia di richiederne uno sostitutivo esclusivamente al produttore o al suo rappresentante.
- Questa unità è adibita solo a uso interno e non è adatta per applicazioni esterne. 
- **Attenzione:** Accertarsi che la lampada V²iLumenAir sia installata saldamente sulla vasca prima di utilizzarla.
- **Attenzione:** Predisporre sempre il cavo di alimentazione DC collegato alla lampada V²iLumenAir con un "drip-loop" (curva di gocciolamento) per evitare che l'acqua, scorrendo lungo il cavo stesso, venga a contatto con l'unità di alimentazione (vedi immagine sottostante).
- **Attenzione:** Non schizzare con acqua o immergere la lampada o l'alimentazione.
- **Attenzione:** Non bloccare le ventole di raffreddamento in nessun modo.
- Per prolungare la durata della vostra lampada mantenerla libera da polvere, sale e altri residui.
- Smaltire l'unità in maniera responsabile. Per ulteriori informazioni sullo smaltimento, rivolgersi al proprio ente locale. 

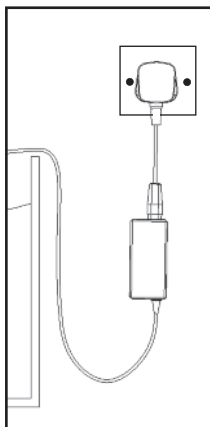

Installazione

È possibile montare V²iLumenAir utilizzando il kit di montaggio vasca (in dotazione) o il kit sospensione (venduto separatamente).

a. Montaggio vasca

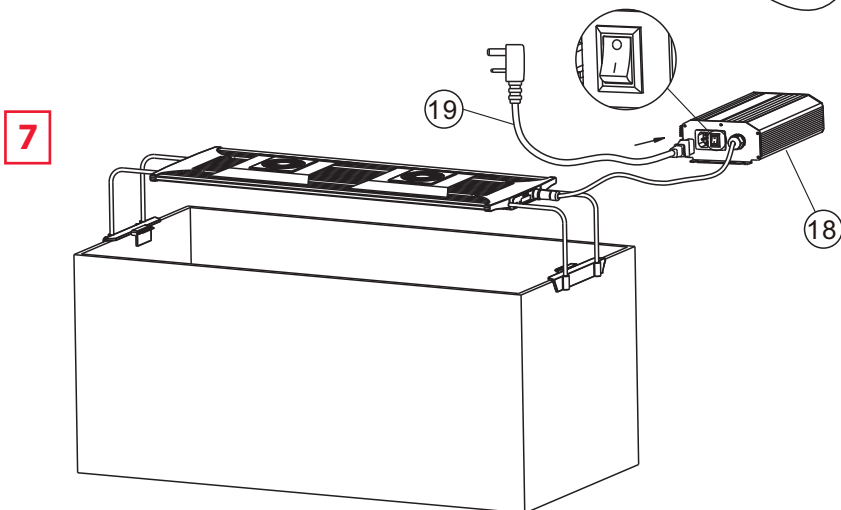
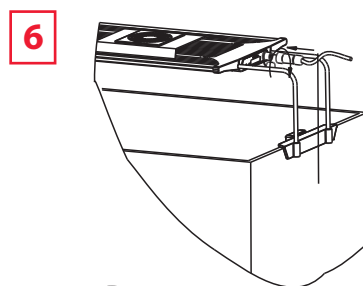
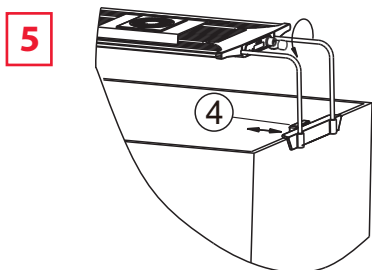
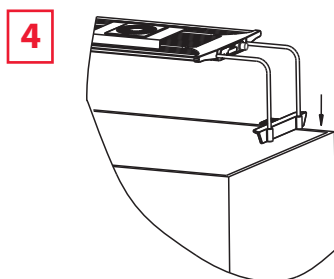
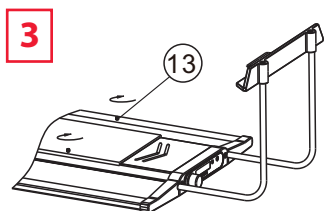
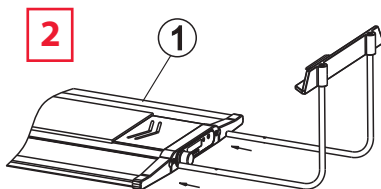
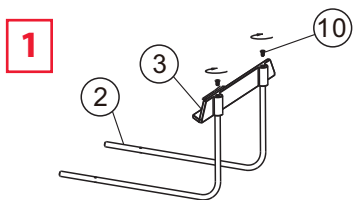



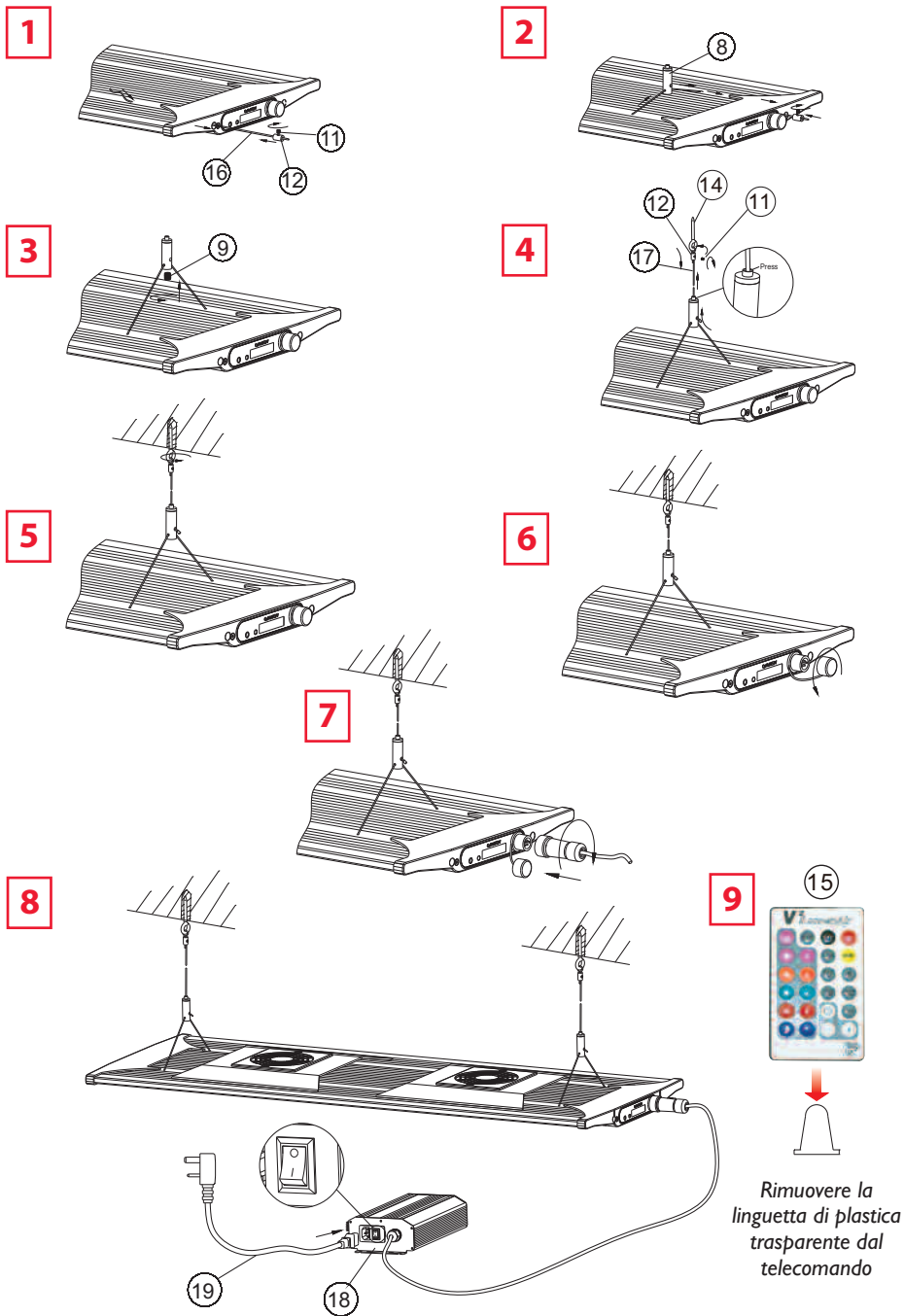

b. Sospensione

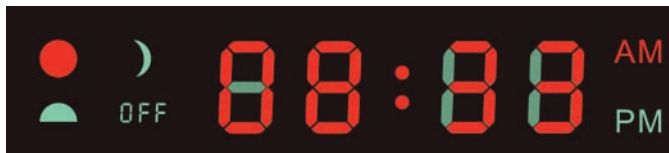

Schermata display



-  è presente in fase diurna.
-  è presente in fase di alba o tramonto.
-  è presente in fase di aurora o luce lunare.
-  è presente quando la luce è spenta.

- In modalità di funzionamento il display mostra l'ora nel formato a 24 o 12 ore.
- Nell'impostazione delle fasi, la prima cifra rappresenta l'intervallo temporale che si sta impostando.

'1' indica aurora
'2' indica alba
'3' indica fase diurna
'4' indica tramonto
'5' indica luce lunare











- La lettera rappresenta il canale LED che si sta impostando.

'A' è il canale del bianco
'b' è il blu
'C' è la combinazione di colori



- Le ultime due cifre indicano il livello di luminosità del canale da '00' a '32'.
- In modalità tempesta il display indica la frequenza dei fulmini da '1' a '8'.
- In modalità demo a colori il display indica la frequenza della variazione di colori da 'Co01' a 'Co12'.
- Se il display visualizza  significa che il sistema è in modalità slave per un'altra unità di controllo.

Istruzioni operative

Messa in funzione rapida

1. Assicurare che la linguetta di protezione in plastica trasparente della batteria sia rimossa dalla parte inferiore del controllore (vedere pagina 49).
2. Per utilizzare il telecomando, puntarlo sul sensore a infrarossi all'ingresso del cavo al sistema di illuminazione.
3. Premere  per impostare l'orologio. Premere una volta per regolare l'ora e due volte per regolare i minuti. Utilizzare   per aumentare o diminuire. L'impostazione dell'ora viene automaticamente salvata dopo 10 secondi, oppure è possibile premere  per tornare al programma utente dopo aver aggiornato l'ora.
4. Premere  per scegliere tra il formato orologio a 24 ore e 12 ore.
5. Premere  per eseguire il programma impostato (dettagli del programma impostato in fabbrica a pagina 53).
6. Premere  per spegnere la luce.
7. Premere  per impostare la modalità tempesta. Utilizzare   per modificare la frequenza dei fulmini.

Premere  per tornare al programma impostato.

8. Premere  per impostare la modalità dimostrativa a colori. Utilizzare   per modificare la velocità dei passaggi. Nelle impostazioni più lente è utilizzabile per simulare il passaggio di nuvole.





Premere  per tornare al programma impostato.

9. Premere  ripetutamente perché il display visualizzi alternativamente la temperatura del sistema di illuminazione in °C e °F e la potenza elettrica assorbita dal sistema di illuminazione in Watt.

10. Premere  per impostare il sistema in modalità slave per un altro controllore (venduto separatamente).



Programmazione

1. Premere  per impostare l'ora di inizio del fotoperiodo. Premere una volta per regolare l'ora e due volte per regolare i minuti. Utilizzare   per aumentare o diminuire.
2. Premere  per salvare le impostazioni.
3. Premere  per impostare la durata della fase di **aurora**. Premere una volta per regolare l'ora e due volte per regolare i minuti. Utilizzare   per aumentare o diminuire.
4. Premere  ripetutamente per scegliere tra il canale del bianco, del blu e della combinazione di colori. Regolare la luminosità di ogni canale utilizzando   per creare l'effetto di aurora preferito.
5. Premere  per salvare le impostazioni.
6. Premere  per impostare la durata della fase di **alba**. Premere una volta per regolare l'ora e due volte per regolare i minuti. Utilizzare   per aumentare o diminuire.
7. Premere  ripetutamente per scegliere tra il canale del bianco, del blu e della combinazione di colori. Regolare la luminosità di ogni canale utilizzando   per creare l'effetto di alba preferito.
8. Premere  per salvare le impostazioni.
9. Premere  per impostare la durata della fase **diurna**. Premere una volta per regolare l'ora e due volte per regolare i minuti. Utilizzare   per aumentare o diminuire.
10. Premere  ripetutamente per scegliere tra il canale del bianco, del blu e della combinazione di colori. Regolare la luminosità di ogni canale utilizzando   per creare l'effetto diurno preferito.
11. Premere  per salvare le impostazioni.
12. Premere  per impostare la durata della fase di **tramonto**. Premere una volta per regolare l'ora e due volte per regolare i minuti. Utilizzare   per aumentare o diminuire.
13. Premere  ripetutamente per scegliere tra il canale del bianco, del blu e della combinazione di colori. Regolare la luminosità di ogni canale utilizzando   per creare l'effetto di tramonto preferito.
14. Premere  per salvare le impostazioni.
15. Premere  per impostare la durata della fase di **luce lunare**. Premere una volta per regolare l'ora e due volte per regolare i minuti. Utilizzare   per aumentare o diminuire.
16. Premere  ripetutamente per scegliere tra il canale del bianco, del blu e della combinazione di colori. Regolare la luminosità di ogni canale utilizzando   per creare l'effetto di luce lunare preferito.
17. Premere  per salvare le impostazioni.

Dopo aver impostato il programma è possibile visualizzare una demo delle impostazioni premendo il tasto **STAR**. Consente di scorrere il fotoperiodo di 24 ore in appena 2 minuti (1 secondo = 10 minuti del ciclo)

NOTA: Se il numero totale di ore nel vostro fotoperiodo è inferiore a 24 ore, la luce si spegne dopo la fase di luce lunare e si riaccende all'ora di inizio. Se il totale supera 24 ore, la parte eccedente le 24 ore viene sostituita dall'aurora all'ora di inizio impostata.

Raccomandazioni per la fase diurna

I suggerimenti seguenti rappresentano solo una guida. I coralli possono essere tenuti negli acquari più profondi. Dovete assicurare che i vostri coralli ricevano la quantità corretta di luce. Consultate il vostro negozio di acquari locale per conferma.

Corallo duro a polipo piccolo

Tutti i canali 100% (32) per vasche profonde 60 cm e oltre

Tutti i canali 90% (29) per vasche profonde 45 cm

Tutti i canali 75% (24) per vasche profonde 30 cm

Corallo duro a polipo grande

Tutti i canali 75% (24) per vasche profonde 60 cm

Tutti i canali 65% (20) per vasche profonde 45 cm

Tutti i canali 55% (17) per vasche profonde 30 cm

Corallo molle











Tutti i canali 65% (20) per vasche profonde 60 cm

Tutti i canali 55% (17) per vasche profonde 45 cm

Tutti i canali 45% (14) per vasche profonde 30 cm

Impostazioni di fabbrica

Per ripristinare le impostazioni di fabbrica premere  poi 

Funzioni	Tasti	Ora iniziale/ durata	Impostazione luminosità		
			Bianco	Blu	Combinazione di colori
Ora di inizio illuminazione		05:00 (Ora de inizio)	-	-	-
Durata e colore per la fase di aurora	 	02:00	1A 01	1B 01	1C 01
Durata e colore per la fase di alba	 	01:00	2A 10	2B 05	2C 28
Durata e colore per la fase diurna	 	10:00	3A 28	3B 28	3C 28
Durata e colore per la fase di tramonto	 	02:00	4A 15	4B 10	4C 30
Durata e colore per la fase di luce lunare	 	03:00	5A 02	5B 10	5C 02

Protezione da sovratemperatura

Le ventole intelligenti iniziano a funzionare quando le luci sono accese alla massima luminosità o la temperatura della luce supera 38°C (100°F) e si fermano quando diminuisce a circa 34°C (93°F). Se il sistema si scalda troppo, a circa 60°C (140°F), la luce si spegne e il display mostra 

Funzionamento della striscia di LED blu

Per controllare la striscia di LED blu, puntare il telecomando sul sensore a infrarossi sul sistema di illuminazione nell'estremità opposta dall'ingresso del cavo.









Premere   per aumentare o diminuire la luminosità della striscia LED blu.

Premere  per disattivarlo e  per riattivarlo.



Premendo  si attenua o aumenta automaticamente la luminosità della striscia per creare un effetto a impulsi.

Ricerca guasti

La luce non funziona

1. Controllare che sia collegata all'alimentazione. In caso contrario, collegarla.
2. Controllare se la luce è in modalità slave o spenta (con il display che visualizza  o ). In caso affermativo premere  per tornare alla modalità di funzionamento.
3. Controllare se la luminosità è impostata su '0'. Premere  o  o  o  o  per regolare il livello di luminosità
4. Controllare che la luce non debba essere spenta secondo quanto impostato nel programma. Consultare pagina 52 per modificare il programma.



La luce è sempre accesa

1. Controllare se il fotoperiodo totale supera 24 ore di durata. Consultare pagina 52 per modificare il programma.
2. Controllare che l'ora sia impostata correttamente. Premere  e   per impostare l'ora.

Lo schermo visualizza

1. Controllare se la parte superiore del sistema e le ventole sono bloccate o coperte. In tal caso rimuovere la polvere/i detriti per garantire una buona ventilazione.
2. Controllare che le ventole stiano funzionando. In caso contrario contattare Tropical Marine Centre o il rivenditore locale per le ventole sostitutive.

Il telecomando non funziona

1. Controllare se la luce è in modalità slave o spenta (con il display che visualizza  o ). In caso affermativo premere  per tornare alla modalità di funzionamento.
2. Controllare che il telecomando sia puntato verso il sensore a infrarossi corretto sul sistema di illuminazione per l'operazione in corso. Consultare pagina 51.
3. Controllare la batteria. È facilmente sostituibile con una batteria a bottone CR2032.



La luce sta lampeggiando

1. Assicurare che la luce non sia in modalità tempesta o demo. Premere  per tornare alla modalità di funzionamento.

V²iLumenAir 900

AANWIJZINGEN VOOR INSTALLATIE EN GEBRUIK

Belangrijke veiligheidsinformatie – Lees dit aandachtig

- **Voorzichtig:** Gebruik geen andere stroomtoevoer met een V²iLumenAir-lamp aangezien de lamp mogelijk niet werkt en dit onherstelbare schade aan de lamp kan veroorzaken. Wanneer de meegeleverde voedingseenheid vervangen dient te worden, vervang deze dan door een originele V²iLumenAir voedingseenheid, die u kunt verkrijgen bij een plaatselijke verdeler van Tropical Marine Centre.
- 
- Isoleer de stroomvoorzieningseenheid altijd van de netvoeding vóór het installeren of het uitvoeren van eventueel onderhoudswerk.
 - **Voorzichtig:** Bedien dit toestel niet als het beschadigd is, als u ziet dat het een beschadigd snoer of een beschadigde stekker heeft, als het niet goed werkt, of als het is gevallen of in water ondergedompeld. Als het externe snoer van deze eenheid beschadigd is, dient het vervangen te worden door een snoer dat uitsluitend beschikbaar is bij de fabrikant van deze eenheid of bij een van zijn leveranciers/vertegenwoordigers.
 - Deze eenheid is ontworpen voor gebruik binnenshuis en is niet geschikt voor toepassingen buiten.
 - **Voorzichtig:** Controleer alvorens de lamp in te schakelen, of de V²iLumenAir-lamp stevig gemonteerd zit boven de tank.
 - **Voorzichtig:** Laat altijd een druipluis in de directe-stroomvoorzieningskabel naar de V²iLumenAir lampeenheid zitten om te voorkomen dat er water langs de kabel naar beneden druipt en in de voedingseenheid terechtkomt.
 - **Voorzichtig:** Spetter niet op de lamp of voedingseenheid en dompel deze niet onder.
 - **Voorzichtig:** Blokkeer de koelventilatoren niet.
 - De lamp gaat langer mee als deze vrij van stof, zout en ander gruis wordt gehouden.
 - Werp deze eenheid op een verantwoordelijke manier weg. Vraag uw plaatselijke overheid om informatie over wegwerpen.
- 
- 

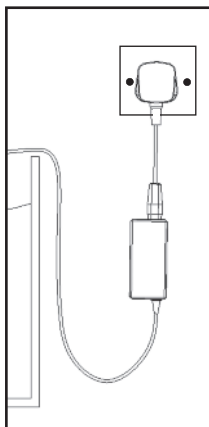

Productspecificatie

Model: V²iLumenAir 900

Afmetingen: 690 x 260 x 24 mm

Geschikt voor aquaria van 730 - 1200 mm lang en 300 – 880 mm breed

Voeding: 100-240 V 50/60 Hz

Totaal vermogen: 179 W

Totale lichtstroom: 9000 lm

Lijst van onderdelen

Zorg dat u alle onderstaande onderdelen hebt.



Draden ophangen

(de betreffende set wordt apart verkocht)

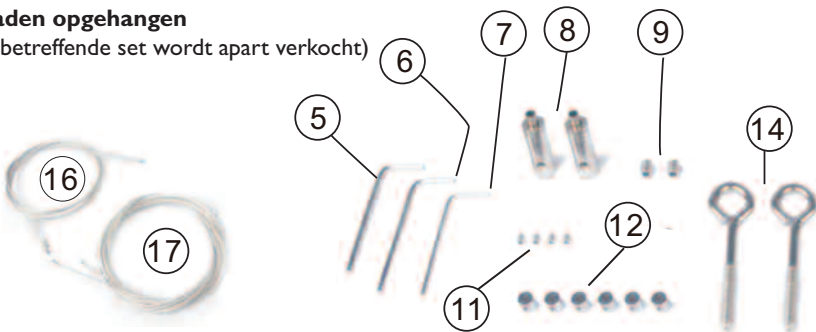

Installatie

De V²iLumenAir kan aan het aquarium worden bevestigd met behulp van de montagekit (meegeleverd) of aan draden opgehangen worden (de betreffende set wordt apart verkocht).

a. Bevestiging aan aquarium

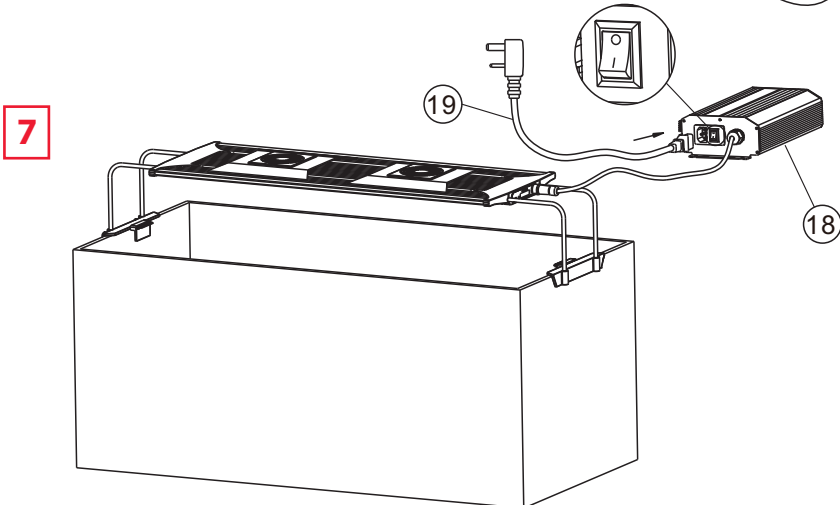
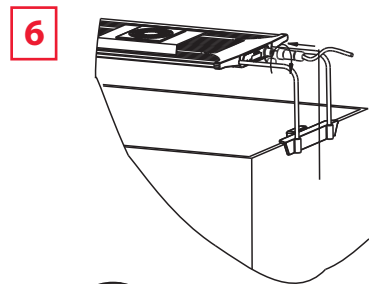
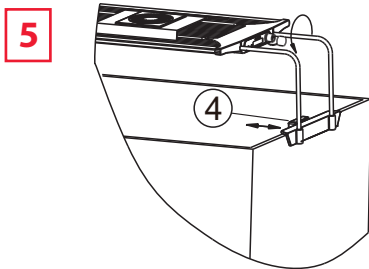
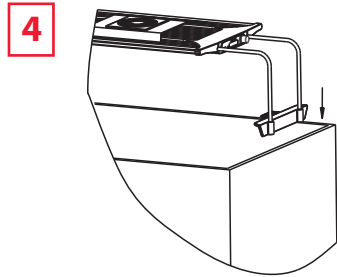
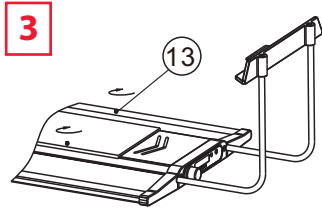
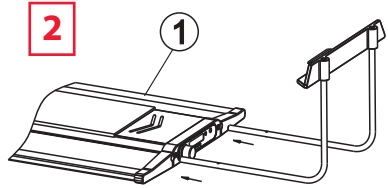
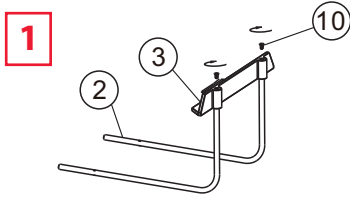

b. Ophanging aan draden

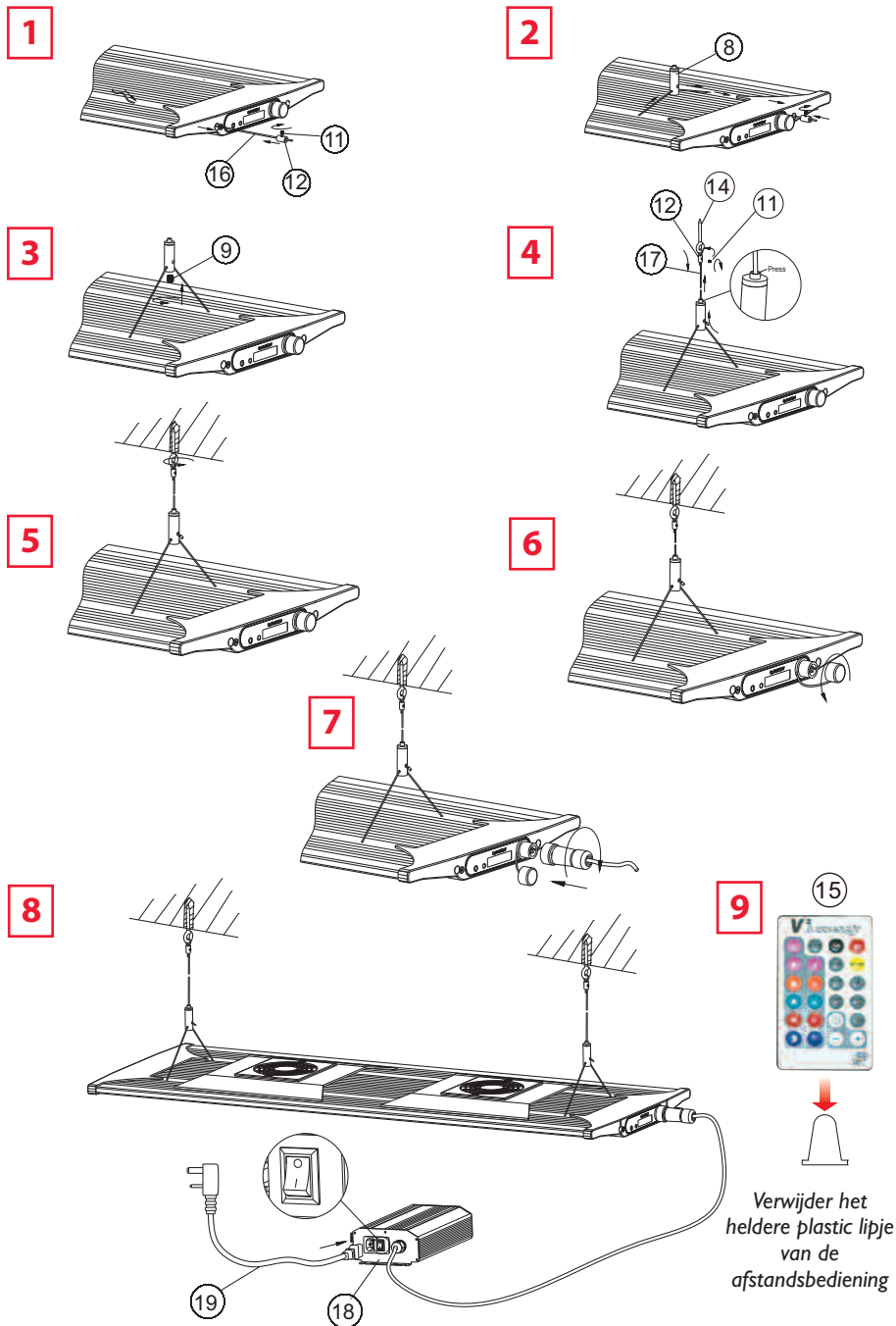

Beeldscherm



Overdag ziet u een



Bij zonsopgang of zonsondergang ziet u



Bij dageraad of maanlicht ziet u



















Als de lamp uit is, ziet u



- Tijdens het gebruik wordt op het display de tijd aangegeven in 24- of 12-uurs notatie.
- Bij het instellen van de fases staat het eerste cijfer voor de periode die u instelt.
 - '1' staat voor dageraad
 - '2' voor zonsopgang
 - '3' voor daglicht / overdag
 - '4' voor zonsondergang en '5' voor maanlicht
- De letter geeft het LED-kanaal aan dat u instelt.
 - 'A' is het witte kanaal
 - 'b' is blauw
 - 'C' is de kleurenmix
- De laatste twee cijfers geven het helderheidsniveau van het kanaal aan van '00' t/m '32'.
- In de modus 'storm' wordt de frequentie van bliksemschichten aangegeven van '1' t/m '8'.
- In de modus kleurendemo wordt de frequentie van de kleurvariatie aangegeven van 'Co01' t/m 'Co12'.
- Als het display  aangeeft, betekent dit deze accessoire afhankelijk is van een andere regeleenheid.







































Gebruiksaanwijzing

Snelstartgids

1. Het heldere plastic lipje ter bescherming van de batterij moet worden verwijderd van de onderkant van de afstandsbediening (zie pagina 58).
2. U gebruikt de afstandsbediening door deze op de infraroodsensor bij de kabelingang naar de verlichtingsarmatuur te richten.
3. Druk op  om de klok in te stellen. Druk eenmaal om het uur in te stellen en tweemaal om de minuut aan te passen. Met   kunt u naar boven of beneden toe afstellen. De tijdsinstelling wordt automatisch opgeslagen na tien seconden, u kunt ook op  drukken om terug te gaan naar het door u ingestelde programma met de bijgewerkte tijd.
4. Druk op  om de 24- of 12-uurs notatie te selecteren.
5. Druk op  om het ingestelde programma uit te voeren (zie pagina 62 voor bijzonderheden over het in de fabriek ingestelde programma)
6. Druk op  om de lamp uit te schakelen.
7. Druk op  om de modus Storm te activeren. Gebruik   om de frequentie van bliksemschichten te wijzigen. Druk op  om terug te keren naar het ingestelde programma.
8. Druk op  om een kleurendemo te activeren. Met   kunt u de snelheid van de overgangen aanpassen. Bij de traagste instelling kunt u deze functie gebruiken om het overdrijven van wolken te simuleren. Druk op  om terug te keren naar het ingestelde programma.
9. Druk meerdere keren op  om te wisselen tussen weergave van de temperatuur van de verlichtingsarmatuur in °C en °F en het stroomverbruik van de verlichtingsarmatuur in Watt.
10. Druk op  om een andere controller (apart verkrijgbaar) de eenheid te laten aansturen.



Programmering

1. Druk op  om de begintijd van de fotoperiode in te stellen. Druk eenmaal om de uren in te stellen en tweemaal om de minuten aan te passen. Met   kunt u naar boven of beneden toe afstellen.
2. Druk op  om uw instellingen op te slaan.
3. Druk op  om de duur van de **dageraad** in te stellen. Druk eenmaal om de uren in te stellen en tweemaal om de minuten aan te passen. Met   kunt u naar boven of beneden toe afstellen.
4. Druk meerdere keren op  om te kiezen tussen het witte, blauwe en kleurmengingskanaal. Stel de helderheid van ieder kanaal af met   om uw eigen dageraad te creëren.
5. Druk op  om uw instellingen op te slaan.
6. Druk op  om de duur van de **zonsopgang** in te stellen. Druk eenmaal om de uren in te stellen en tweemaal om de minuten aan te passen. Met   kunt u naar boven of beneden toe afstellen.
7. Druk meerdere keren op  om te kiezen tussen het witte, blauwe en kleurmengingskanaal. Stel de helderheid van ieder kanaal af met   om uw eigen zonsopgang te creëren.
8. Druk op  om uw instellingen op te slaan.
9. Druk op  om de duur van het **daglicht** in te stellen. Druk eenmaal om de uren in te stellen en tweemaal om de minuten aan te passen. Met   kunt u naar boven of beneden toe afstellen.
10. Druk meerdere keren op  om te kiezen tussen het witte, blauwe en kleurmengingskanaal. Stel de helderheid van ieder kanaal af met   om uw eigen daglicht te creëren.
11. Druk op  om uw instellingen op te slaan.
12. Druk op  om de duur van de **zonsondergang** in te stellen. Druk eenmaal om de uren in te stellen en tweemaal om de minuten aan te passen. Met   kunt u naar boven of beneden toe afstellen.
13. Druk meerdere keren op  om te kiezen tussen het witte, blauwe en kleurmengingskanaal. Stel de helderheid van ieder kanaal af met   om uw eigen zonsondergang te creëren.
14. Druk op  om uw instellingen op te slaan.
15. Druk op  om de duur van het **maanlicht** in te stellen. Druk eenmaal om de uren in te stellen en tweemaal om de minuten aan te passen. Met   kunt u naar boven of beneden toe afstellen.
16. Druk meerdere keren op  om te kiezen tussen het witte, blauwe en kleurmengingskanaal. Stel de helderheid van ieder kanaal af met   om uw eigen maanlicht-effect te creëren.
17. Druk op  om uw instellingen op te slaan.

Nadat u uw programma hebt ingesteld, kunt u een demo bekijken van uw instellingen als u op  drukt. Daarmee doorloopt u de 24 uur fotoperiode in iets meer dan 2 minuten (1 seconde = 10 minuten van de cyclus)

OPMERKING: Als het totale aantal uren in uw fotoperiode minder is dan 24, dan wordt de lamp uitgeschakeld na de maanlichtfase en weer ingeschakeld bij de begintijd. Als het totale aantal uren meer is dan 24, wordt het gedeelte na 24 uur vervangen door de dageraad bij de ingestelde begintijd.

Aanbevelingen daglicht

De onderstaande suggesties dienen alleen als richtlijn. Korallen kunnen in diepere aquaria worden gehouden. U dient ervoor te zorgen dat de korallen de juiste hoeveelheid licht krijgen. Vraag uw plaatselijke viswinkel om advies als u het niet weet.

Kleine poliepsteenkoraaal

Alle kanalen 100% (32) voor aquaria met een diepte van meer dan 60 cm

Alle kanalen 90% (29) voor aquaria met een diepte van 45 cm

Alle kanalen 75% (24) voor aquaria met een diepte van 30 cm

Groot poliepsteenkoraaal

Alle kanalen 75% (24) voor aquaria met een diepte van 60 cm

Alle kanalen 65% (20) voor aquaria met een diepte van 45 cm

Alle kanalen 55% (17) voor aquaria met een diepte van 30 cm

Zacht koraaal







Alle kanalen 65% (20) voor aquaria met een diepte van 60 cm

Alle kanalen 55% (17) voor aquaria met een diepte van 45 cm

Alle kanalen 45% (14) voor aquaria met een diepte van 30 cm

Fabrieksinstellingen

Als u de fabrieksinstellingen wilt herstellen, drukt u op  en daarna op 



Functies	Knoppen	Begintijd/ duur	Helderheid instellen		
			Wit	Blauw	Kleurenmix
Begintijd licht		05:00 (Begintijd)	-	-	-
Duur en kleur dageraad		02:00	1A 01	1B 01	1C 01
Duur en kleur zonsopgang		01:00	2A 10	2B 05	2C 28
Duur en kleur daglicht		10:00	3A 28	3B 28	3C 28
Duur en kleur zonsondergang		02:00	4A 15	4B 10	4C 30
Duur en kleur maanlicht		03:00	5A 02	5B 10	5C 02

Beveiliging tegen oververhitting

De intelligente ventilatoren treden in werking als de lampen voluit branden of als de temperatuur van de lamp meer dan 38 °C bedraagt en stoppen weer als de lamp is afgekoeld tot ca. 34 °C. Als de eenheid te warm wordt, rond 60 °C, wordt de lamp uitgeschakeld en geeft het display  aan.

Bediening blauwe LED's in strip

Richt voor de aansturing van de blauwe LED's in de strip de afstandsbediening op de infraroodsensor op de verlichtingsarmatuur aan het andere uiteinde van de kabelinvoer.









Druk op   om de helderheid van de blauwe LED te verhogen of verminderen.

Druk op  om deze uit te zetten en op  om deze weer aan te zetten.

Als u op  drukt, neemt de helderheid van de strip automatisch af en weer toe, en dat geeft een pulseffect.

Problemen oplossen

De lamp werkt niet

1. Controleer of deze op de voeding is aangesloten. Zo niet, doe dat dan alsnog.
2. Controleer of de lamp zich in de modus Slaaf bevindt of uit staat (display geeft  respectievelijk  aan). Druk in dat geval op  om terug te keren naar de modus Uitvoeren.
3. Controleer of de helderheid is ingesteld op '0'. Druk op  of  of  of  of  om de helderheid af te stellen.
4. Controleer of de lamp volgens uw ingestelde programma uitgeschakeld hoort te zijn. Zie pagina 61 voor informatie over het aanpassen van het programma.



De lamp brandt voortdurend

1. Controleer of de totale fotoperiode meer dan 24 uur bedraagt. Zie pagina 61 voor informatie over het aanpassen van het programma.
2. Controleer of de tijd goed is ingesteld. Druk op  en   om de tijd in te stellen.

Op het scherm wordt weergegeven

1. Controleer of de bovenkant van de eenheid en ventilatoren geblokkeerd of afgedekt zijn. Indien ja, verwijder dan stof/vuil om een goede luchtstroom op gang te brengen.
2. Controleer of de ventilatoren werken. Zo niet, wend u dan tot Tropical Marine Centre of uw plaatselijke dealer voor nieuwe ventilatoren.

De afstandsbediening werkt niet

1. Controleer of de lamp zich in de modus Slaaf bevindt of uit staat (display geeft  respectievelijk  aan). Druk in dat geval op  om terug te keren naar de modus Uitvoeren.
2. Controleer of de afstandsbediening op de juiste infraroodsensor op de verlichtingsarmatuur is gericht voor de functie die u wilt gebruiken. Zie pagina 60.
3. Controleer de batterij. Deze kan eenvoudig worden vervangen door een knoopcel van het type CR2032.

De lamp knippert

1. Controleer of de lamp niet in de modus storm of demo staat. Druk op  om terug te keren naar de modus Uitvoeren.

Social Media and Other On-line Services



www.tropicalmarinecentre.co.uk

Our main website is packed full of product information, tips and interesting articles.

Catalogues and instructions can be downloaded from this site and you can also access our "find a dealer" tool which helps you locate stockists of your specified TMC products or fish species.

Facebook & Twitter

"Like" us on Facebook
Tropical Marine Centre
or follow us on Twitter
@TropicalMarine

to keep up to date with the latest TMC news and product releases, as well as seeing sneak peeks from the fish house.

YouTube

Video footage of our livestock is showcased on our YouTube Channel
tropicalmarinecentre

Subscribe to our channel now to be the first to see our newest arrivals!



TMC Dealer Portal

The TMC "Dealer Portal" allows our network of retailers to view our current livestock availability lists and place on-line orders for livestock and dry goods.

This means they can instantly check availability of any of the particular species you are looking for and order it in for you there and then, giving you the highest level of customer care and access to our newest arrivals.

If you are a trade customer and would like to set up a portal account please visit:-

<http://dealers.tropicalmarinecentre.co.uk/Register.aspx>



Tropical Marine Centre,
Solesbridge Lane,
Chorleywood,
Hertfordshire, WD3 5SX, UK

Technical Information Lines

Tel: +44 (0) 1923 284151 Fax: +44 (0) 1923 285840

Open between

9am - 5pm Monday to Thursday/9am - 12pm Friday.

www.tropicalmarinecentre.co.uk tmc@tropicalmarinecentre.co.uk