



- Différentes tendances
- Grand éventail de couleurs de lames (panachage possible)
- Ergonomique et discret
- S'adapte sur la majorité des menuiseries, sur l'ouvrant entre parclose, y compris sur oscillo-battants
- Ouverture de la fenêtre sans remonter le store

Nouveaux coloris et aspects des lames
Confort et Confort Déco.

Cale d'écartement* (1 jeu fourni) s'emboîtant au dos des étriers afin de compenser un manque de profondeur de feuillure

Étriers à fixer par vissage dans la menuiserie permettant de tendre le guidage et de relier le boîtier au lambrequin

Cale de fixation (fournie) pour s'adapter à une parclose arrondie ou moulurée

Lambrequin (section 48 x 13) en aluminium laqué recouvrant le boîtier supérieur en acier laqué (section 25 x 25)

Lames aluminium de 16 ou 25 mm : coloris voir page suivante ou sur le sélecteur

Cordons de levage

Échelles

Câbles de guidage perlon fin avec réglage de la tension dans le boîtier

Barre de charge en acier laqué

Clou en PVC pour fixer le guidage en partie basse dans la menuiserie à percer Ø 3 mm directement (menuiserie PVC, Alu ou Acier) ou via des inserts filetés (Ø 4 mm) en laiton* en option (menuiserie bois)

Tendances disponibles



Manceuvre

Par chaînette à gauche ou à droite : orientation et levage combinés.
Conseil : Placer de préférence la manœuvre côté paumelle et prévoir, en cas de profil de recouvrement sur une fenêtre à double vantaux une éventuelle décote de lambrequin.*











Bloqueur de chaînette

Chaînette PVC

*Options pouvant être soumises à plus-value.











Pour plus de détails techniques, veuillez vous référer aux pages suivantes. À noter, suivant l'évolution de nos produits, le descriptif peut être modifié.













































TENDANCE	NEIGE	SABLE	TERRE	MÉTAL	ROCHE
LAMBREQUIN	 RAL 9016 Brillant*	 RAL 1015 Satiné*	 RAL 8014 Satiné*	 RAL 9006 Satiné*	 RAL 7016 Satiné*
BOÎTIER / BARRE DE CHARGE	 Code 0150	 Code 4451	 Code 4851	 Code 7113	 Code 1601
MANŒUVRE CHAÎNETTE	Blanc	Sable	Marron	Gris clair	Gris clair
CORDON DE TIRAGE	Blanc	Beige	Marron	Gris clair	Gris clair
ÉCHELLES	Blanc	Beige	Marron	Gris clair	Gris clair
EMBOUT DE BOÎTIER	Translucide	Translucide	Translucide	Translucide	Translucide
EMBOUS BARRE DE CHARGE	Translucide	Translucide	Noir	Gris clair	Translucide
SERRE ÉCHELLE	Translucide	Translucide	Noir	Gris clair	Translucide
EMBOUT DE LAMBREQUIN	Cristal	Cristal	Cristal	Cristal	Cristal

Couleurs des lames

Gamme Primo, épaisseur 0,18 mm

 BLANC Mat Code 8150	 VANILLE Mat Code 8350	 ARGENT Métallisé Code 8113	 GRIS FONCÉ Brillant Code 8604
 BLANC Brillant Code 8204	 CAMEL Brillant Code 8806	 GRIS CLAIR Brillant Code 8605	 NOIR Mat Code 8858
 BEIGE Mat Code 8459	 ALUSTAR Brillant Code 8710	 GRIS MOYEN Mat Code 8952	

Gamme Confort, épaisseur 0,22 mm

 Éclat BLANC Code 0204	 Pailleté DORÉ Code 7120	 Brossé VANADIUM (Satin) Code 7344	 Satin BLEU AVIATEUR Code 2352
 Satin BLANC Code 0150	 Satin MOKA Code 4756	 Tissé PERLE (Velours) Code 7453	 Tissé CIEL (Satin) Code 7428
 Velours BLANC Code 2599	 Boisé CAFÉ (Satin) Code 7542	 Éclat PERLE Code 0606	 Satin CIEL Code 2358
 Perforé BLANC (Satin) Code 0051	 Satin CACAO Code 4851	 Satin GRIS Code 0952	 Satin VERVEINE Code 3750
 Poudré MAGNOLIA Code 7221	 Boisé CORSÉ (Satin) Code 7544	 Éclat ALUMINIUM Code 7010	 Satin MIEL Code 4156
 Perforé MAGNOLIA (Satin) Code 9544	 Perforé ÉBÈNE (Satin) Code 7581	 Tissé ALUMINIUM (Satin) Code 7430	 Satin COQUILLE Code 4451
 Satin MAGNOLIA Code 4459	 Satin ÉBÈNE Code 1858	 Perforé ALUMINIUM (Éclat) Code 0107	 Satin POUPON Code 4259
 Tissé MAGNOLIA (Velours) Code 7419	 Velours ÉBÈNE Code 1861	 Pailleté ALUMINIUM Code 7113	 Satin HÂLÉ Code 5953
 Velours MAGNOLIA Code 4495	 Éclat GRÈS Code 1601	 Satin LAVANDE Code 2056	 Satin ROUGE Code 5250
 Éclat DUNE Code 4806	 Velours GRÈS Code 1510	 Satin CALYPSO Code 2258	
 Tissé DORÉ (Satin) Code 7431	 Satin POUSSIÈRE Code 1650	 Satin INDIGO Code 2251	

Gamme Confort Déco, épaisseur 0,22 mm

 Velours POMME Code 3991	 Poudré CERISE Code 7225	 Satin RAISIN BLANC Code 2851	 Éclat ROMARIN Code 2507
 Velours CITRON Code 4088	 Velours FRAMBOISE Code 5895	 Poudré SAUGE Code 7223	 Satin CHLOROPHYLLE Code 3251
 Velours MANDARINE Code 5799	 Velours PITAYA Code 5898	 Velours HORTENSIA Code 2491	 Velours PRUNE Code 5082
 Satin CASSIS Code 2156	 Velours LITCHI Code 5899	 Velours CENTAURÉE Code 2685	



Prise de mesures

Attention ! En cas de doute sur la compatibilité du châssis, veuillez nous consulter

Largeur de commande : Largeur clair de vitre

Hauteur de commande : Hauteur de vitre

Profondeur de feuillure : 19 mm minimum

(si moindre, prévoir 1 ou 2 paires de cales d'écartement supplémentaires épaisseur 4 mm)

Hauteur d'allège : Hauteur du bas du store au sol (pour avoir la manœuvre à bonne portée)

Décote de lambrequin à prévoir côté opposé à la manœuvre dans le cas d'une fenêtre à double ouvrant avec profil de recouvrement central : de 0 à 17 mm maxi

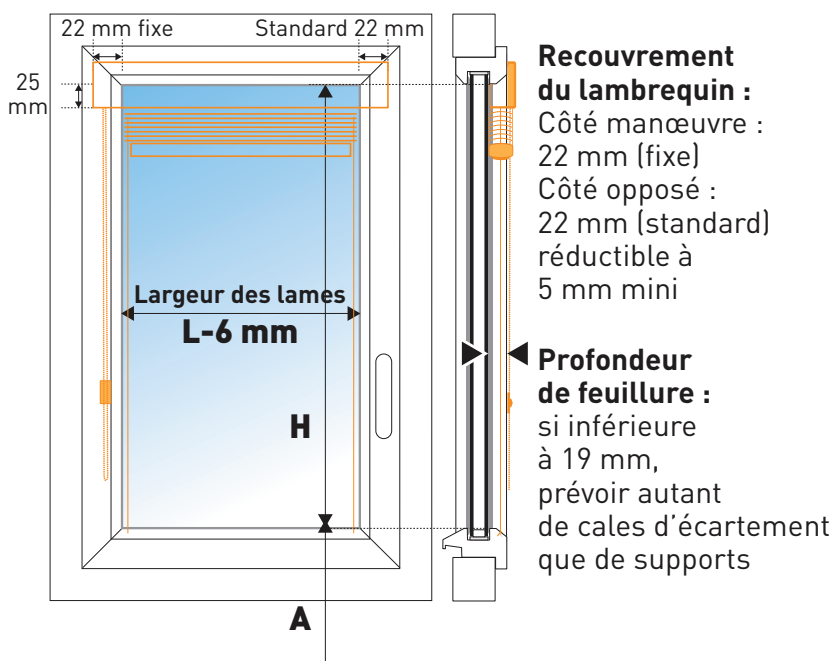

Limites dimensionnelles

	Largeur de 285 à 364	Largeur de 365 à 1900
H maxi	2000 mm	2300 mm
S maxi Lames 25 mm	2,5 m ²	2,5 m ²
S maxi Lames 16 mm	2 m ²	2 m ²
Repli	Voir à droite de la grille tarifaire	

Tolérances de fabrication

L : ± 2 mm,
H avec lames 25 mm : 0 à +25 mm,
H avec lames 16 mm : 0 à +16 mm.

Tolérances d'horizontalité des lames

± 2 mm / mètre de hauteur /
cordon de levage

Options de pose

Cale d'écartement

Coloris blanc
Cale de 4 mm
pour compenser un manque de profondeur de feuillure (minimum requis : 19 mm)

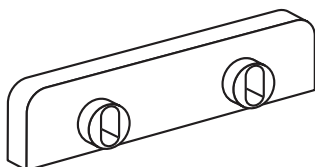

Cale de fixation

Coloris blanc
Cale pour la fixation des supports sur parclose arrondie ou moulurée

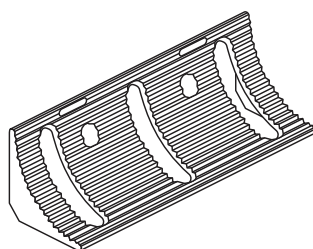

Jeu de 2 inserts en laiton filetés

