

# Making Number Make Sense STEP Progression in Calculations

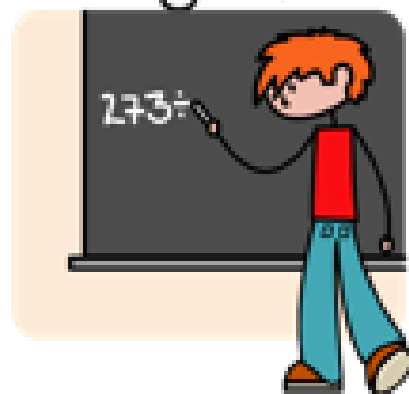
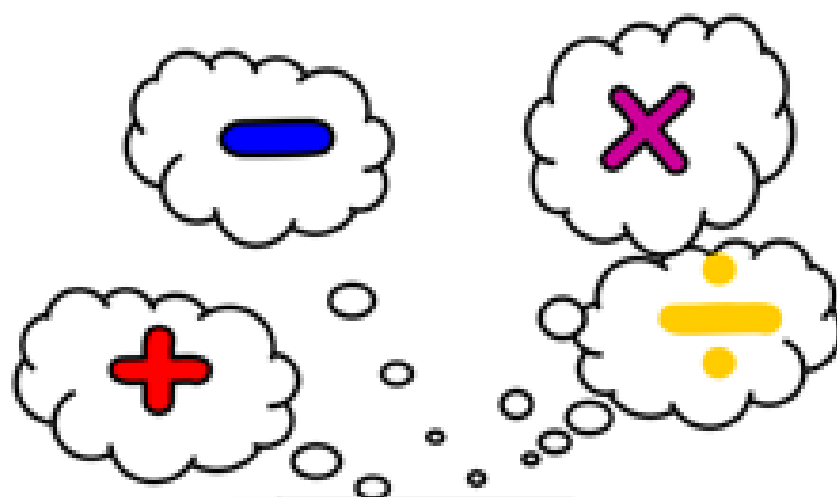

April 2014

## Introduction

Written methods of calculations are based on mental strategies. Each of the four operations builds on mental skills which provide the foundation for jottings and informal written methods of recording. Skills need to be taught, practised and reviewed constantly. These skills lead on to more formal written methods of calculation.

Strategies for calculation need to be supported by familiar models and images to reinforce understanding. When teaching a new strategy it is important to start with numbers that the child can easily manipulate so that they can understand the concept.

The transition between stages should not be hurried as not all children will be ready to move on to the next stage at the same time, therefore the progression in this document is outlined in stages. Previous stages may need to be revisited to consolidate understanding when introducing a new strategy.

A sound understanding of the number system is essential for children to carry out calculations efficiently and accurately.

## Progression in Teaching Addition

### Mental Skills

Recognise the size and proportion of numbers.

Count on in ones and tens.

Know number bonds to 10 and 20.

Add multiples of 10 to any number.

Partition and recombine numbers.

Bridge through 10.

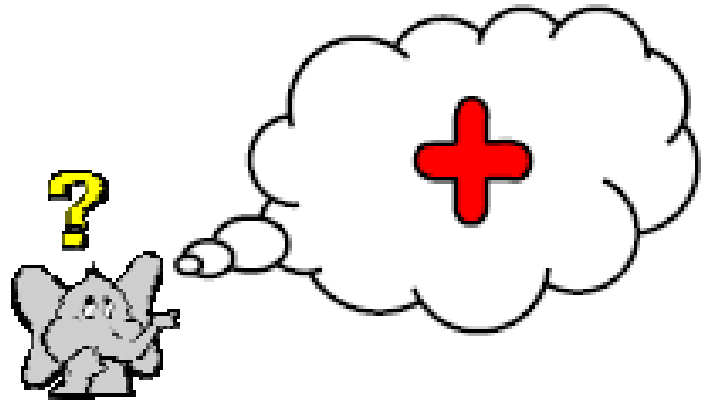

### Models and Images

Counting apparatus

Place value apparatus

Place value cards

Number tracks

Numbered number lines

Empty number lines

Hundred square

Counting stick

Bead string

Models and Images charts

ITPs-Number Facts, Ordering Numbers, Number Grid, Counting on and back in ones and tens.

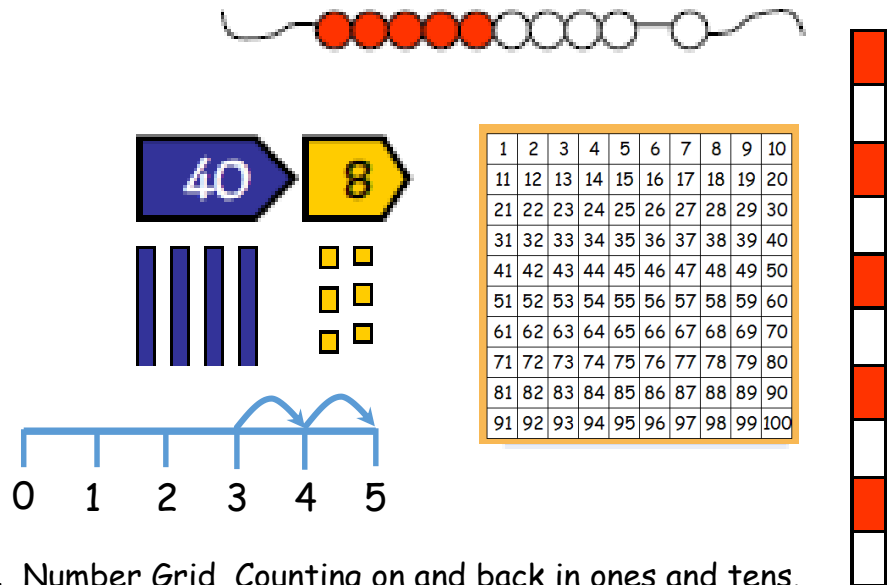

### Key Vocabulary

Add

Addition

Plus

And

Count on

More

Sum

Total

Altogether

Increase

add and count on  
addition plus  
more sum total  
altogether increase

Recognise numbers  
0 to 10

0 1 2 3 4 5 6 7 8 9 10



1,2,3,4,5,6...there  
are 6 teddies

Count reliably up to 10 everyday objects

Find one more than a  
number

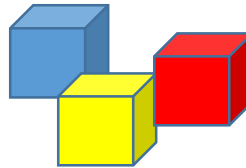

One more than  
three is four

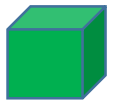

1	2	3	4	5	6	7	8	9	10
11	12	13	14	15	16	17	18	19	20
21	22	23	24	25	26	27	28	29	30
31	32	33	34	35	36	37	38	39	40
41	42	43	44	45	46	47	48	49	50
51	52	53	54	55	56	57	58	59	60
61	62	63	64	65	66	67	68	69	70
71	72	73	74	75	76	77	78	79	80
81	82	83	84	85	86	87	88	89	90
91	92	93	94	95	96	97	98	99	100

Count in ones and tens



$$12 + 10 = 22$$



Begin to relate addition to  
combining two groups of objects

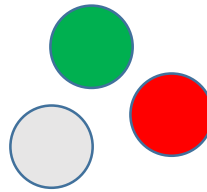

and

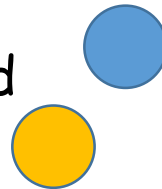

makes 5

$$3 + 2 = 5$$

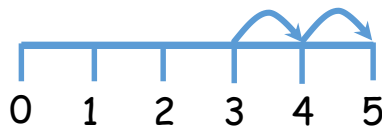

Count along a number line to  
add numbers together

Begin to use + and = signs to record mental  
calculations in a number sentence.

$$6 + 4 = 10$$

$$10 = 7 + 3$$

Use the + and = signs to record  
calculations in other ways

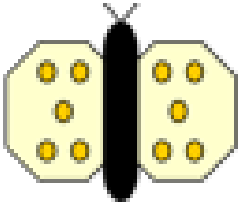

$$5 + 5 = 10$$

Know doubles of numbers

Know by heart all pairs of numbers with a total of 10 and 20.

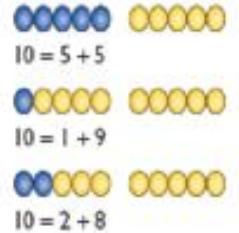
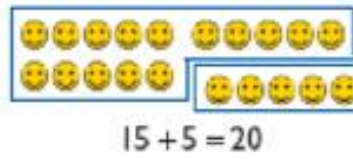
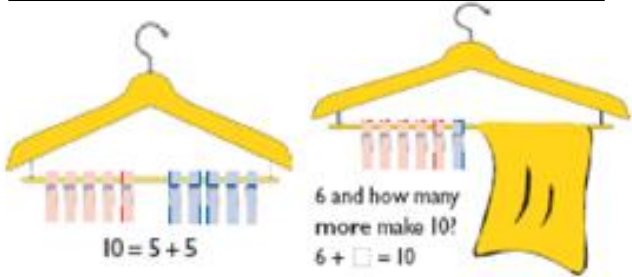
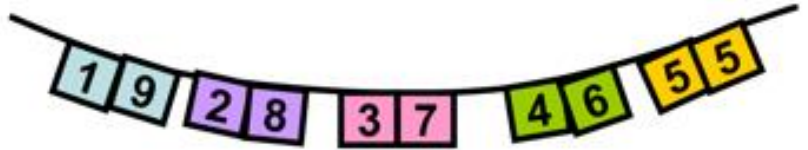

Solve number sentences with missing numbers for pairs of number with a total of 10 and 20.

$$1 + 2 = 3$$



$$2 + 1 = 3$$



$$2 + 5 = 7$$

2 count on 5



$$5 + 2 = 7$$

5 count on 2

Know that addition can be done in any order.

Put the biggest number first and count on.

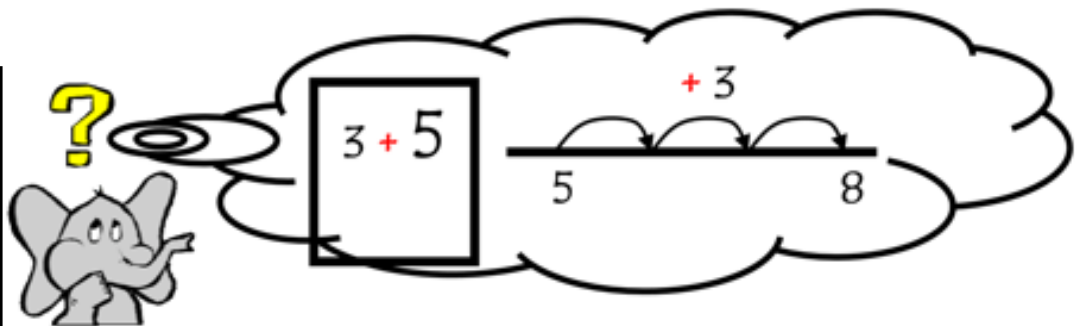

$$8 + 7 = 15$$

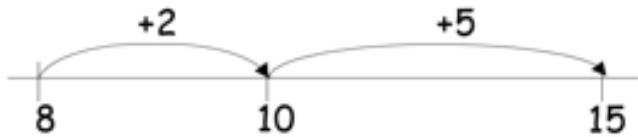

Add two single-digit numbers that bridge 10

Work out the missing numbers for addition number sentences.

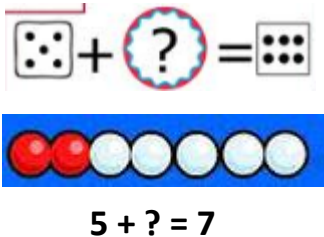
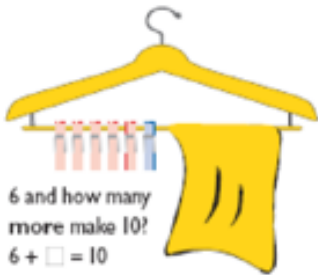

Begin to partition numbers in order to add.

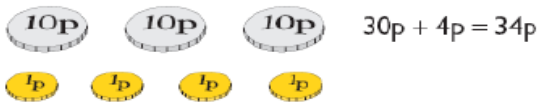
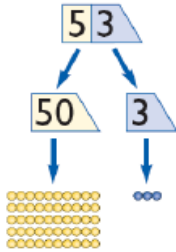

Know which digit changes when adding 1s or 10s to any number.

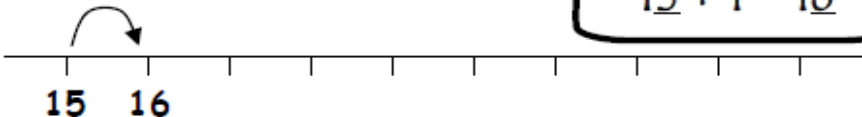

$$15 + 1 = 16$$

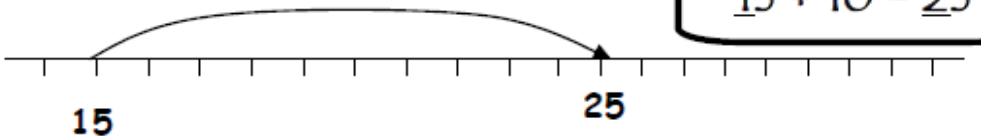

$$15 + 10 = 25$$

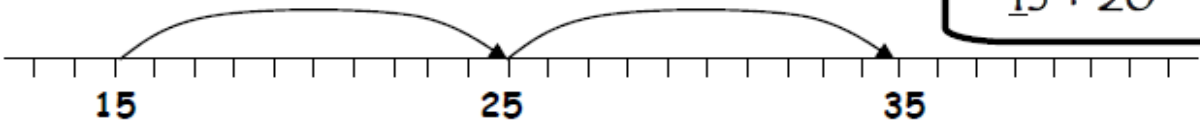

$$15 + 20 = 35$$

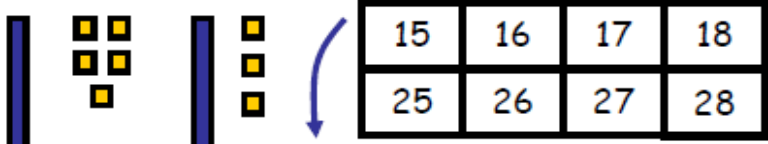

Adding two two-digit numbers (without bridging). Counting in tens and ones. Partitioning and recombining.

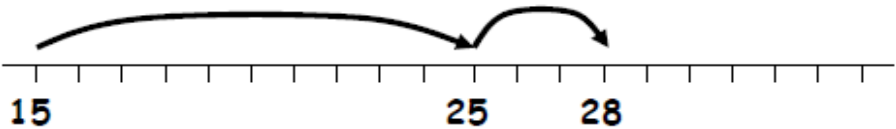

$$15 + 13 = 28$$

Adding two two-digit numbers  
(bridging through tens boundary).  
Using a number line  
OR  
Using place value cards and place value  
apparatus to partition numbers and  
recombine.

$$48 + 36 = 84$$

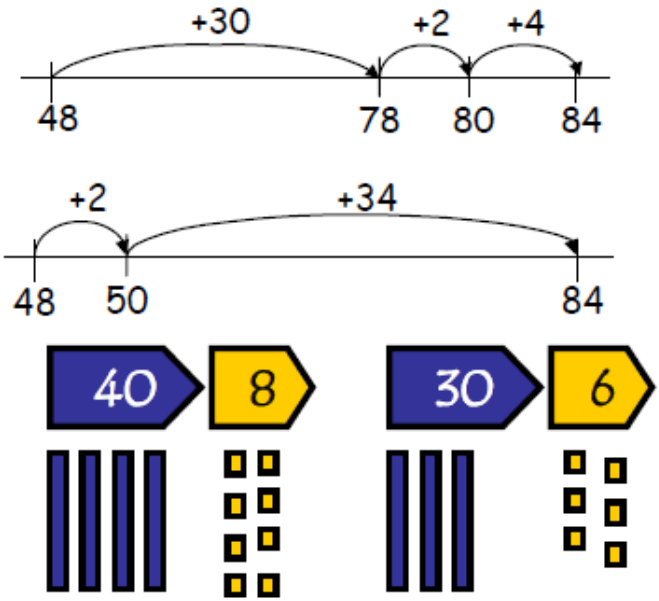

$$\begin{array}{r}
 40 + 30 + 8 + 6 \\
 \hline
 40 + 30 = 70 \\
 8 + 6 = 14 \\
 70 + 14 = 84
 \end{array}$$

Expanded method

It is important that the children have a good understanding of place value and partitioning using concrete resources and visual images to support calculations. The expanded method enables children to see what happens to numbers in the standard written method,

$$48 + 36$$

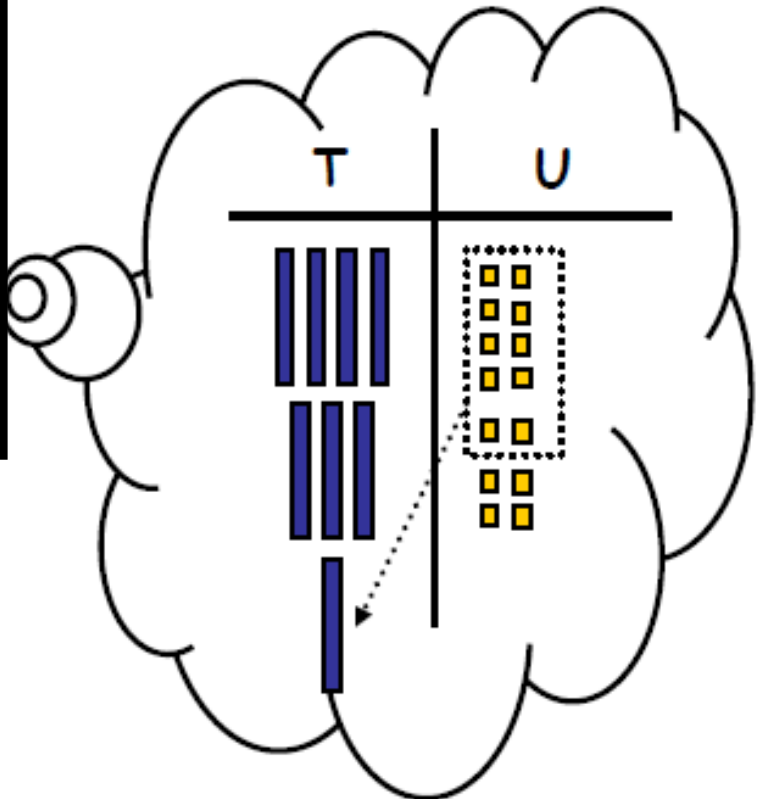

## Key Stage 2

$$48 + 36$$

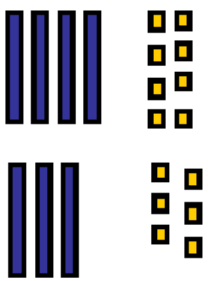
$$\begin{array}{r} 48 \\ +36 \\ \hline 14 \\ 70 \\ \hline 84 \end{array}$$

$$8 + 6 = 14$$
$$40 + 30 = 70$$

Children write an expanded method using jottings.

NB: Model use of correct place value vocabulary.  $40 + 30 = 70$  rather than  $4 + 3 = 7$

Set out with deans equipment as shown to link to earlier work.

$$5.3 + 2.8$$

$$\begin{array}{r} 5.3 \\ + 2.8 \\ \hline 1.1 \\ 7.0 \\ \hline 8.1 \end{array}$$
$$0.3 + 0.8 = 1.1$$
$$5 + 2 = 7$$

Children write an expanded method using jottings to add decimals.

NB: Model use of correct place value vocabulary. 3 tenths add 8 tenths equals 11 tenths



368

+493

11

150

700

861

Children write an expanded method  
without using jottings.

48

+ 36

84

1

This compact written method is  
only introduced once the above is  
secure.

Emphasise correct place value  
language:

forty + thirty + ten = eighty

**NOT**

four + three + one = eight