

HOW WILL YOU MAKE IT?

WHERE WILL YOU MAKE IT?

WHO IS IT FOR?

WHO WILL MAKE IT?

WHAT WOULD YOU MAKE A
FILM ABOUT?

WHO WILL HOLD THE
CAMERA?

WHO WILL KEEP TIME?

WHO WILL MAKE TEA?

WHAT WILL IT LOOK LIKE?

Written by Ed Webb-Ingall and
People Make Videos, who are:
Birdman, Dirmuid, Ismail, Jessica,
Kazi Noor Jahan and Robert.

Edited by Louise Shelley
and Ed Webb-Ingall

Designed by Rosie Eveleigh
Printed by Art Quarters Press

People Make Videos was published and
commissioned by The Showroom as part
of the Communal Knowledge programme,
which is generously supported by Paul
Hamlyn Foundation, City Bridge Trust,
the City of London Corporation's Charity,
John Lyon's Charity and Garfield Weston
Foundation.

Additional Funding provided by
The Department of Media Arts,
Royal Holloway, University of London.

The London Community Video Archive
(LCVA) was established in 2016, to
archive, recover and revive a selection
of community videos from the 1970
to 1985. For more information or to
arrange a free screening of community
videos please contact lcva@gold.ac.uk
or follow us on twitter @theLCVA.

LCVA is a member of London's Screen
Archives Network, managed by Film
London and is supported by the Heritage
Lottery Fund and Goldsmiths University
London.

This manual and the work of People Make
Videos is indebted to the community
video groups that came before us
including: Albany Video, West London
Media Workshop, Interaction, Liberation
Films, Walworth and Aylesbury
Community Arts Trust, Community
Action Centre, Channel 40, Amber, Four
Corners, Fantasy Factory, Graft On!,
Tower Hamlets Arts Project and many
others.

Licensed under Creative Commons
Attribution-NonCommercial-ShareAlike
4.0 International.

2016

3 OWNERSHIP AGREEMENT

4 TRIGGER FILMS

5 TECHNICAL KIT LIST

6 STORYBOARD

7 FIRST MEETING GUIDE

8 CAMERA GAMES

9 FILMING TECHNIQUES

10 SHOT LIST

11 SOUND AND VOICE OVER

12 EDITING

13 PUBLIC SCREENING EVENT

14 FEEDBACK FROM PEOPLE MAKE VIDEOS



INTRODUCTION

What does it mean to share a space
together, to ask someone else what they
think, to look at the world through a video
camera and know that someone else will
take the time to watch it back? People
Make Videos is a project initiated to ask
these questions.

As public spaces and services are shut
down and privatised and surveillance is
increased, People Make Videos lays claim
to the importance of collectively occupying
a space together and of taking up the
means of production and representation
on our own terms. This manual is not a
suggestion that there is only one way to
run a community video project, we hope
it is a starting point, a provocation, a
trigger* to learn from what we have been
doing in order to self organise, to take
up the means of representation, to start
campaigns, to document change, to put
pressure on those in positions of power,
to engage new community video projects.

In the early 1960s video recording
technology remained largely the concern
of television studios, accessible only to
unionized professionals. Fast forward
ten years and video had become portable,
no longer just for the television elite, it
was something that could be worn over
one shoulder by artists and activists
to make community videos. 'Community
video' has hitherto evaded strict definition,
considered anew each time a group who
share a neighbourhood or interest chooses
to take up a video camera in order to
collectively produce a video for, by and
about themselves. This manual draws on
the processes developed by community
video makers in the 1970s and the videos
they subsequently made, in order to think
about how we might make community
videos in 2016.

* We are using the the term 'Trigger' here as it was used in
the 1970s as if to 'spark' or 'initiate'. We are aware that it
has taken on a different meaning in a contemporary context.

People Make Videos started with a question:

What would you
make
a film about?

The question was posed by one person to
a neighbourhood. That one person met with
a number of small groups who shared an
interest in a building or a street.

Together we began to collect answers
to the question and we added two more
questions:

Who is it for?
and
Who will make it?

These groups watched videos together
and learned to make their own videos.
All the groups met up and, with their
friends and families, they watched each
others' videos and ate and talked and
asked a new question:

What next?

What happened next was members of the
individual groups began to meet monthly
in order to learn more from each other and
make their own videos. We have been doing
this for a year now and have decided it is
time to share again.

The politics of this practice is embedded
in the process, in each member's own
responses, outputs and in the production
of this manual. To call a group together
on the question 'what would you make a
film about' is a call for solidarity, a call
to attend to the difficult question of: what
is our community, how do we represent it
and to what end?

OWNERSHIP AGREEMENT

Before we turned on the camera, before we pressed the record button, before we talked about what we might make a video about, we made an agreement together.

As a group we discussed what about making a video might make us feel uncomfortable. For example, some people said they didn't want their faces on camera, others said they didn't feel comfortable holding a video camera in public, some people found it hard hearing their voices played back. It was helpful to come up with solutions to these concerns as a group, for example you might decide that the whole video might just be of the hands and feet of participants. We also talked about where the finished video might end up and asked questions such as:

Will it just be for us?
Will there be a public screening?
Who might we invite?
Will it go online?
If so where?
Will it be password protected?
Will we be able to share it with friends and family?

We then talked about who will own the footage and where it will be stored. We stored all the footage we shot on an external hard drive, ideally on two, so that you have a backup of everything.

We agreed that any footage recorded in the room was owned by the group and that if anyone in the group wanted to make anything out of the footage they would have to get permission from the whole group.

Once you have reached your own agreement relevant to your project it might be helpful to make a note of this on a sheet of paper and perhaps even all sign it.

As the project progresses you might find it helpful to check in regularly about the initial agreement in case you find out if anything has changed.

Other things that might be included in the agreement:

How regularly will we meet?
Who will be in charge of equipment?
How long might the project last for?
What do we hope to get out of the project?

TRIGGER FILMS

Starting a project is often the hardest part – but don't let this put you off. We started looking around and seeing what else had been made already that we might find interesting and inspiring either in the way it looked, the way it was made or what it was made about.

We learnt about the idea of a Trigger Film. This was something that goes back as far as the 1970s when community video groups first started. They would choose a film or video that was relevant to their interests and watch it together. After watching the video together they would then have a conversation about the kind of video they might like to make. It is a way to start thinking about what might be possible and of interest for the group to make a video about. Here's how they did it in the 1970s. The following process is based on a community video project developed by community film and video group Liberation Films with people living in Balham, South London in 1974.

TRIGGER FILM

Contact is made with a community group who are enthusiastic about participating in the project. The project team visits the community and shoots a fifteen-minute film about the area, in which they interview local residents about their attitudes to living there and their response to local community activities.

COMMUNITY FILM SHOW

The film is then shown in an evening as the last part of a screening of films about other London communities. The event, held in a local hall, library or social space is publicized widely in the area. Following the screening group discussions provide an opportunity for people to talk about themselves and the place where they live, the trigger film providing a shared focal point.

INTRODUCTION TO VIDEO

The discussion following the trigger film is videotaped by the project team, who attempt to involve local people in using the video cameras to interview each other. Those who are most enthusiastic are then invited to make their own videotapes about their community.

USING THE VIDEO CAMERAS/ MAKING A TAPE

This newly formed group then meets with the project team and is trained in the basic

use of the technology. The objectives of the group are discussed and agreed. The emphasis is on fun and experimentation rather than technical skills. Simple exercises are carried out in order to gather ideas and explore issues.

EDITING THE TAPE

The group meets up on several occasions to view and assess the video material. Together they decide how to edit and structure the final video. They also agree on a date and format for presenting the video to the community.

COMMUNITY VIDEO SHOW

A screening event is advertised with posters and flyers throughout the neighbourhood inviting the community to watch the newly made video and be part of a discussion.

INTER-COMMUNITY FILM SHOW

The original community group will be encouraged to take the video they have made to other communities and set up community film shows there – so that the original film can now operate as a trigger film.

There are three types of Trigger Film that we found helpful:

1. Old films and videos that showed the place we live in at a different time – these helped us think about what has changed and what has stayed the same. We asked questions such as: if this video was made now what would it look like and who would make it?

2. Before the first meeting two members of the group went into the local neighbourhood and recorded short interviews with members of the public to find out what they thought of the area they lived, what they liked and didn't like and even asked them what they might like to see a video made about. This was then screened to the group to start a discussion.

3. Various types of non-fiction films from news reports, to documentaries, to experimental artists films helped us to think about the ways we might approach certain subjects and about choosing the form a video might take in relation to the chosen subject and content.

TECHNICAL KIT LIST

All video cameras are slightly different although most have similar functions. We always tried to use a digital video camera as opposed to a mobile phone camera. Not everyone has access or feels comfortable with this kind of camera. Video cameras have a presence in the room that say "I am interested in what you have to say." It is often hard with smartphones to know when you are being recorded, with video cameras it is much clearer.

They are easy to pass around and light enough to handle for most people – we had a rule that the handstrap and the longer strap should always be used this was for safety and also meant for more stable shots. If you put the strap around neck and then hold the camera with the hand strap away from the body it can make the camera very steady.

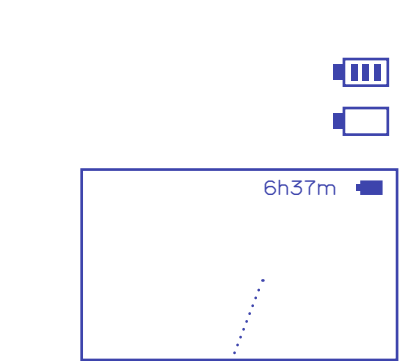

VIEWFINDER
When you turn the camera on you will see how much memory the camera has left, usually displayed as a percentage or the number of minutes. There will also be an icon that shows how much battery you have left.

PLAYBACK
To watch back what you have recorded there should be a button that looks like a triangle in a box. Push this and it should reveal the footage you have shot so far. You can then select the clip from the thumbnails on screen and press play to watch them back. Push the same button again to return to the record mode.

- Recording
- ▶ Play
- ⏸ Pause
- 🗑 Delete
- ⏩ Fast Forward
- ◀ Rewind
- ▶ Slow playback
- ◀ Slow rewind

ZOOM
We tried to avoid using the zoom whilst the camera was recording as it made us feel a bit sea sick when we watched it back, instead it helps to set up a shot and then press record.

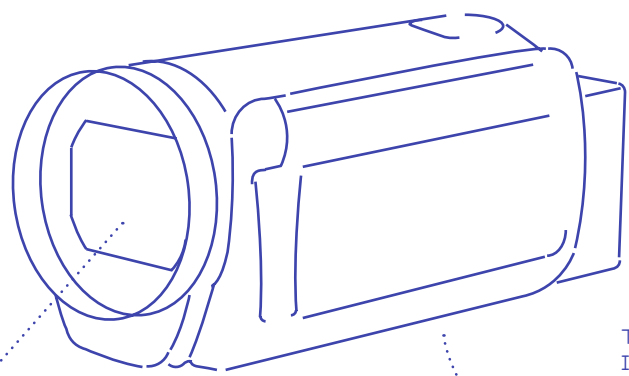

LENS
Avoid touching the lens at all costs, keep the lens cap in the same place when you are not using it so you always know where it is.

TRIPOD
If you would like a steady shot try attaching a tripod to the bottom of the camera.

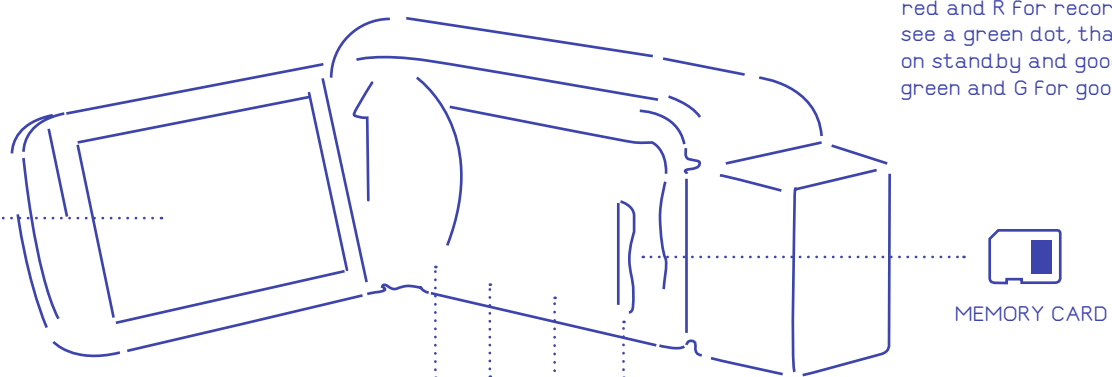

RECORD
An easy way to remember if the camera is recording is if you see a red dot it is recording, R for red and R for recording, if you see a green dot, that means it is on standby and good to go G for green and G for good to go.

HEADPHONES
Plug in headphones to check what it will sound like when you play it back.

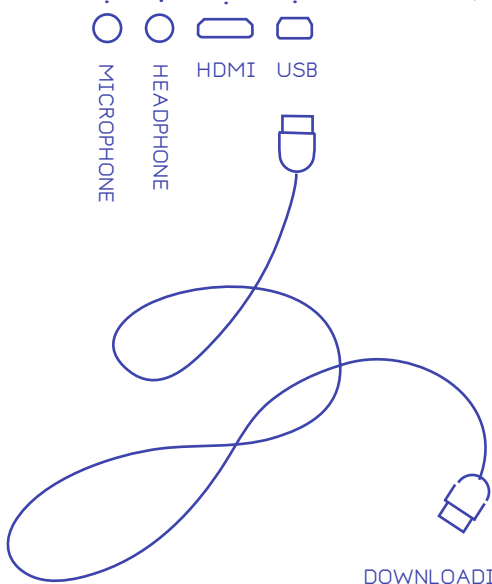

CHARGING THE BATTERY
Make sure you download footage from the camera after you use it and charge it at the same time. This way you will always be ready to go.

DOWNLOADING FOOTAGE
Footage is usually transferred using a USB wire (or similar) direct from the camera to your computer or else you remove a memory card, pushing it in lightly will release it you can then insert that into a card reader. Be sure to label folders carefully using the working title of the project and the date if you can.

STORYBOARD

When working as a group and when time is precious a storyboard can be really helpful. It helps to plan shots and to visualise the flow of information you intend to communicate. Don't worry if you struggle with drawing, we ended up writing short descriptions of what we wanted to video and also what kind of

shot we might use (For filming techniques and ideas for different shots see pages 9 and 10).

Try to think through as much information as possible in advance as this will help when editing (For more information on editing see page 12).

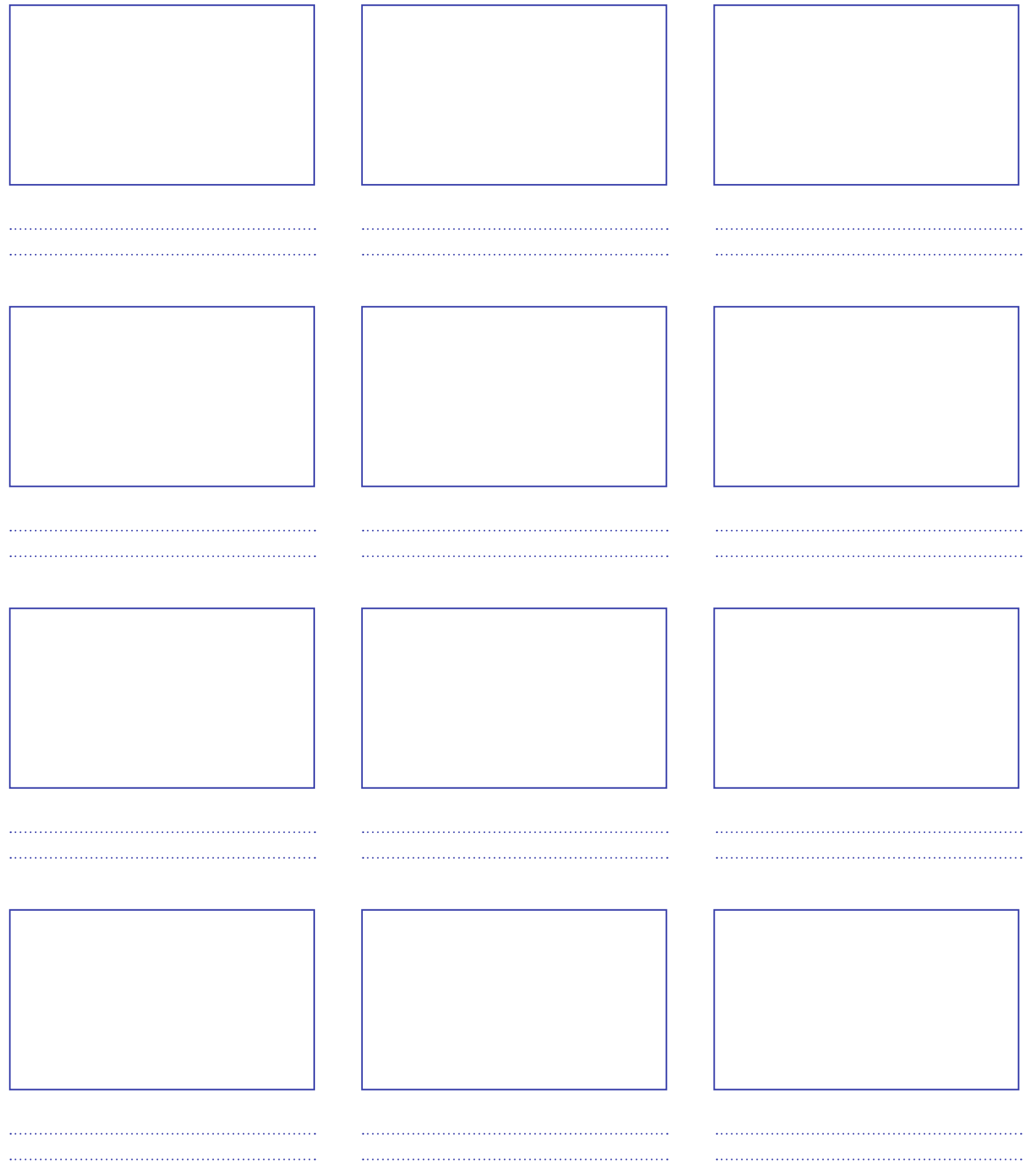

FIRST MEETING GUIDE

Make sure everyone feels welcome. As people arrive get into pairs to find out the other person's name, what brings them to the meeting and if they have any experience of filmmaking.

Once everyone is seated you could go around the circle and take turns introducing the person you met and what you found out about them. For those who are new to the group it is useful to let them know the rough structure of the meeting, including any breaks and any previously agreed outcomes.

We would then recommend watching a short video of about 10 minutes that has been chosen specifically for the group – either due to its content, the structure, the themes covered or because of where or when it was made.

After the screening everyone can then take turns saying one thing it made them think or feel or if it is a big group try getting everyone to ask the person next to them what they thought was surprising about the video they just watched and then telling the group what the other person said – this exercise is good to get people talking to one another and practice asking questions and listening.

INTRODUCING THE CAMERA

Next, one person who is more confident using the camera can take it out of its case, turn it on and show the group how to hold it and to make it start and stop recording. Whilst everyone is sat in a circle, pass the camera around whilst it is recording and ask everyone to say the first thing it makes them feel or think of. Make sure everyone has a go at holding the camera in a way that they feel comfortable with and that they try out the on/off, zoom and record/pause buttons. Be sure to help the person next to you if they are unsure of anything.

Pass the camera around again, this time each person should ask the person next to them if it is ok to record them, if they say no then ask if it is ok to film another part of them – suggest hands or shoes. Once this agreement is established, set up the shot and check it in the viewfinder, press record and ask them a question, such as: how does it feel to be filmed?

GO OUTSIDE

We then went out into the neighbourhood and each took a turn videoing one thing that made us think of the word 'community'. As we videoed, we narrated what we were recording and why we had chosen it. This formed a live voiceover or soundtrack. If there are more than 5 people, it might be helpful to have two cameras and to divide into two smaller groups.

If you try this exercise out a bit later on it might be fun to play around with different kinds of shots and framing (see page 10). One thing that helped us was to think about each shot being like a moving photograph, we would try changing the frame in order to reveal

certain things, cover them up or get close or far away from something.

It is important with this exercise that we all agreed on a time to meet back at the meeting place and perhaps designate one person in each group to be the timekeeper. This exercise took us about 20 minutes in total.

PLAYBACK

If you have time we found it really exciting to be able to watch back what we had recorded and talk about it with the rest of the group, it got us excited to think about what we might do next and learn different ideas about using the video camera from one another. It is fine if you can't watch it all back, but skip through the footage and show a bit from everybody if you can. Although it might not be ideal, we found that if we didn't have time to connect the cameras and transfer the footage it was fine to stand around the camera and watch back footage on the foldout screen.

ONE LAST THING

Ask everyone in the group to spend 5 minutes responding in writing to the following questions:

What would you make a film about?
What would it look like?
Who would it be for?

And then take turns presenting each idea to the rest of the group. This really helped us plan and envisage what might happen at the next meeting.

At the end of each session, if we had time we would each say one thing we learnt or that surprised us about the meeting.

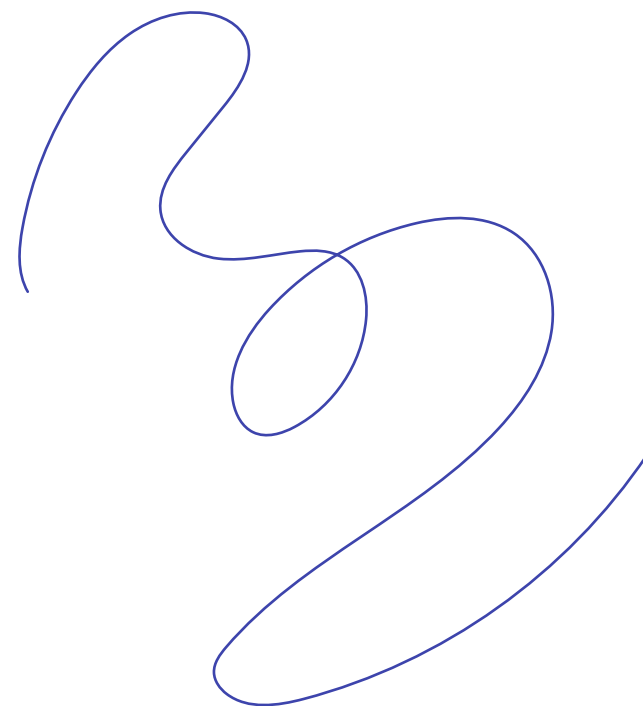

7

CAMERA GAMES

If you have time why not try the following game. One person holding the camera asks the following question to the person next to them and records the answer:

IF
(BLAH)
were a
(BLANK)
what
(BLANK)
would it be?

Take turns asking one another this question, keeping BLAH the same and changing BLANK each time. Try and get the person answering to insert the question into their answer.

IF
THE PLACE
WHERE YOU LIVE
were a
SOUND
what
SOUND
would it be like?

FEEDBACK LOOP

We carried out this exercise at the end of most meetings in order to share ideas and reflect on the experience of working together.



1
Carry on until everyone has had a go in front of and behind the camera.



2
Everyone sits in a chair.

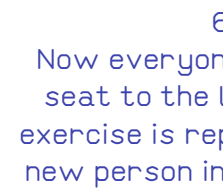

3
Now everyone moves one seat to the left and the exercise is repeated with a new person in front of and behind the camera.



4
The person sat behind the camera turns the camera on and asks the person sat in front if they are comfortable being on camera.



5
Once they have answered, the person behind the camera can either ask a follow up question, or if they are satisfied with the answer they can press stop recording.

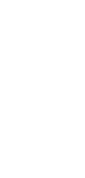

6
Once they are made to feel comfortable the person sat behind the camera presses record and asks the person in front of the camera a question about the session they have just taken part in, such as 'what was one thing that surprised you about using a video camera?'



8

FILMING TECHNIQUES

Vox Pop

This involves asking people their opinion on an issue or concern that might affect them. It can be quite intimidating, an important thing we learnt is that you probably have a lot in common with the person you are interviewing and so to make them feel comfortable just think about how you would like to be treated and spoken to. It really helped if we came up with a set of questions together in advance and did a practice-run with one another before going out into the public.

First Person/Voice Over

When you add a spoken word audio track after you have recorded the original footage. This way you can plan what you want to say a bit more and record it in a quieter setting. Sometimes it can feel a bit unfamiliar and overbearing. Perhaps there are techniques you can think of that make it feel intimate.

Slide Show

This is when instead of using moving image footage you make a compilation of still images that are shown one after the other – perhaps recorded from a pin board, on a table or in a photo album. You can then add a voiceover or music afterwards so that the pictures tell a story or make a particular point. What is fun about this is that it can allow for experiments with how you show the pictures in order to create different experiences for the viewer – moving quickly through multiple images or lingering over certain elements.

News Report

This would look like a regular news broadcast you might see on television – with a person standing in front of the camera presenting a straightforward opinion or set of ideas often with the speaker looking into the camera and directing their attention to the audience. It can be fun to play with this role in order to subvert the authoritative delivery one usually expects from the news.

Observational Footage

The camera follows the action, doesn't get involved and acts like a fly-on-the-wall, so that the viewer becomes part of the action. Think about your relationship to the subject in front of the camera and what power they have over the way that they are being represented.

Group Discussion

The camera is part of the conversation and might be on a tripod outside of the circle or else it can be passed around the group. Think about the subject matter you would like to cover, also be aware of how this might be edited, people might forget the camera is there and say things in the heat of the moment that they wish they hadn't.

FROM THE MUNDANE TO THE EXTRAORDINARY

Use the video camera and see if you can record for one minute a day for five days. Video things that sum up how you spend your time. Where do you go? What do you do? What is your routine? Who do you meet? You could video inside and outside of buildings, what you eat, the people you interact with, your journeys by foot and by bus, things around the house, things you find beautiful or interesting. You decide and importantly don't worry about any choices just enjoy the process.

SHOT LIST

Close-up

A camera shot taken at a very short distance from the subject, to permit a close and detailed view of an object or action.

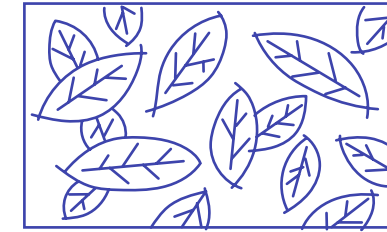

Wide Shot

This shot is often used to show where the subject is located. It is often referred to as an 'establishing shot' because it establishes where the scene takes place.

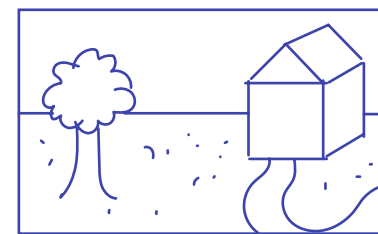

Medium Shot

This shows some part of the subject in more detail, whilst still showing enough for the audience to feel as if they were looking at the whole subject. In fact, this is an approximation of how you would see something "in the flesh."

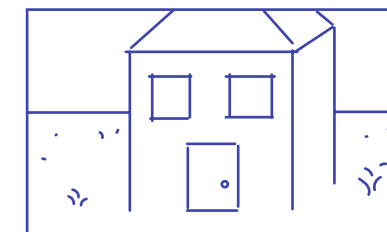

Crop

Refers to the removal of the outer parts of an image to change the frame, or draw attention to a specific part of the subject.

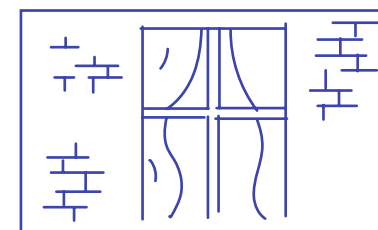

Why not try attaching the camera to a projector and making a live feed, then as a group try each of these shots out?

Pan

Moving a camera on its vertical or horizontal axis to make it go left to right or up and down.

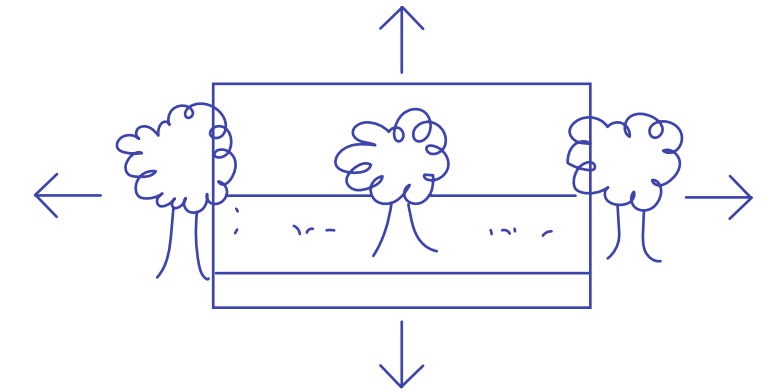

Interrupt

You might be holding a shot and then want to interrupt it with your hand or other body part or an object or another person to cover over a certain element or the whole frame.

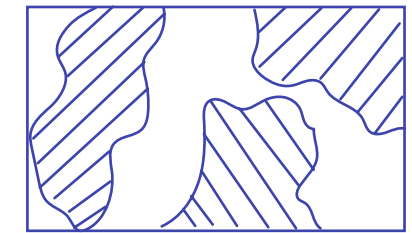

Zoom

Using the zoom feature on the camera to artificially get closer or further away from the subject to reveal or conceal parts of the shot.

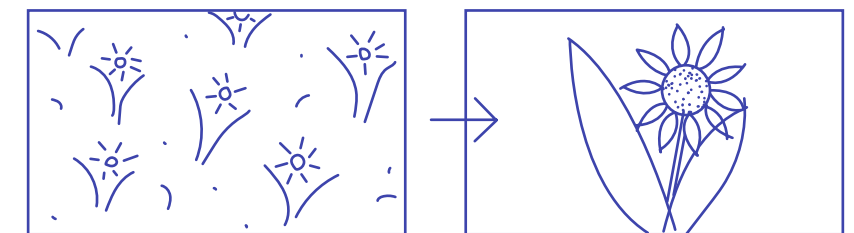

Your Shot

Think about your height, your hands, your body and how this affects how you might see something and what you would like to film and how you hold the camera – use this to frame and record.

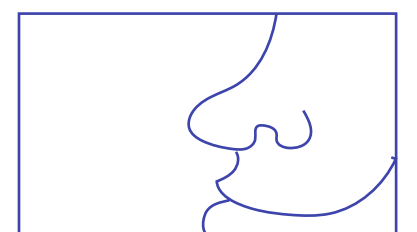

SOUND AND VOICE OVER

The relationship between sound and image was made most acute when we started trying to edit before we had decided on the sound for our videos and then again when we started trying to plan soundtracks and voiceover before we had a final edit. In the end it was a bit back and forth, with one leading the other.

Sound can be used to enhance a video in various directions: it can change the mood by matching or going against the pace and content, it can add drama or nostalgia, and it can be poetic or informative. Our group used sound in three ways:

Commentary

After watching our footage back we realised it needed more explanation and so we wrote a script and recorded ourselves reading it back and then added this to the footage in the edit.

Live Soundtrack

Sometimes we wanted the videos we made to appear naturalistic and so we used the sound that was recorded when we shot the original footage.

Music and Sound Effects

We were fortunate enough to have a few musicians in our group who kindly volunteered their skills for the benefit of the group – we recorded songs, drumming, whistling, clapping and built up a layered soundtrack to compliment the footage we had recorded.

If you are planning on doing any recording afterwards make sure you find a quiet room where you won't be disturbed. You can use the microphone on the camera and just use the sound or else borrow a dictaphone or lots of phones have audio recorders.

What advice would you give someone developing a soundtrack?

Sound is essential for communication, choose something from the heart and mind – I chose to sing a poem by Rabindranath Tagore.

Listen and observe, it can enhance/supplement visual narrative.

Think about what soundtrack will enhance or complement and tie in with your video.

Have different options to play around with.

Capture a good deal of raw audio material to give yourself plenty to work with in the editing stages. Don't worry if some strikes you as 'useless' or 'limited' in appeal or relevance as the meaning or significance can surface later in the creative process, as your ideas develop.

What advice would you give to someone using voice over?

Consider if you want ambient or background sounds captured. Leave spaces between spoken words/sentences to enable easier more effective edits to be made. Record different versions as there will be aspects you like about one, others you might want to drop.

Be natural, engage the viewer/listener – you're having a conversation with them.

Think of the tone and refine it.

You can use song and description, poetry and dialogue.

EDITING

Editing is the assembly of footage to create a flow of information, it is also one of the real sticking points with any collective video making process. There are two approaches that we developed to try and work around the problem of too many cooks and not enough patience, technology and know-how.

Editing in Camera

When we only had a few meetings in total we did what is known as 'editing in camera'. To do this you will need to shoot scenes in the order in which you would like them to appear and add any sound you might like live, making sure you delete any unwanted scenes as you go along. To help us achieve this we would plan shots using a storyboard (see page 6), for those of us who weren't so good at drawing we used the boxes on the storyboard to write brief descriptions of what we would like to happen in each scene. The result is very satisfying as you will be able to watch back the finished video as soon as you finish recording.

Paper Edit

When we started working on longer form projects we decided that we would work with an editor who would trim and arrange our video footage for us. In order to do this, whilst not driving the editor mad, we each carried out a paper edit. This is a way to prepare your raw, unedited files for the editor – a form of pre-editing, where you watch all of the footage and make editing notes using the time codes and file names as reference numbers/names. To begin with, watch through all of your video clips and select a rough amount of footage to show to the group that you imagine including in a final edit. Note down the file name/number and the 'in' and 'out' time of the section you would like to possibly use. It can help to add a few words describing the footage too.

What advice would you give someone doing a paper edit?

Watch everything slowly, decide which one will be nice and write it down.

Review your images and take time out to order them in sequence. Think a beginning, a middle and an end. Ask yourself what the point of the video is.

Keep some notes about your objectives, the message, themes duration.

Write down the exact time of the clip you want to use and the file number and include a brief description. Have one folder for original footage and one for work in progress.

These are some things we considered when we were choosing our clips:

Does it relate to an overall theme? What is that theme?

Do you relate to it personally?

It was also fine for us to choose clips for more abstract reasons, just because we liked the look of it.

Imagine you are trimming a fish or meat cut/joint to remove the gristle or hairs. The resulting fillet will look/sound so much more appealing.

PUBLIC SCREENING EVENT

How will you present the videos? Will there be programme notes printed so that the audience know what to expect? Will someone introduce the event and explain what will happen and where the toilets and fire exit are?

We have found that even the most simple of refreshments help to create a relaxed atmosphere and get people talking. We are lucky enough to have some fantastic bakers and cooks in our group who have provided some delicious treats at our events.

After the screening, in order to encourage discussion we divided the audience into smaller groups, designating one filmmaker to each group to help facilitate the conversation. It was helpful to have a list of questions prepared. Instead of focusing on what you liked or didn't like, perhaps begin by asking what the videos made them think about or feel. The findings from these smaller discussions can then be fed back to the rest of the group at the end of the event. Tidy up and pack away. Don't be shy to ask everyone, who is able, to help pack chairs away, as it saves a lot of time. It is best if they don't help packing away anything technical or expensive.

What next? Agree on a follow up plan in advance so that if anyone at the screening would like to get involved in a future project you know what to say. Perhaps you have a date in mind for your next meeting or a plan for your next video project and are looking for volunteers.

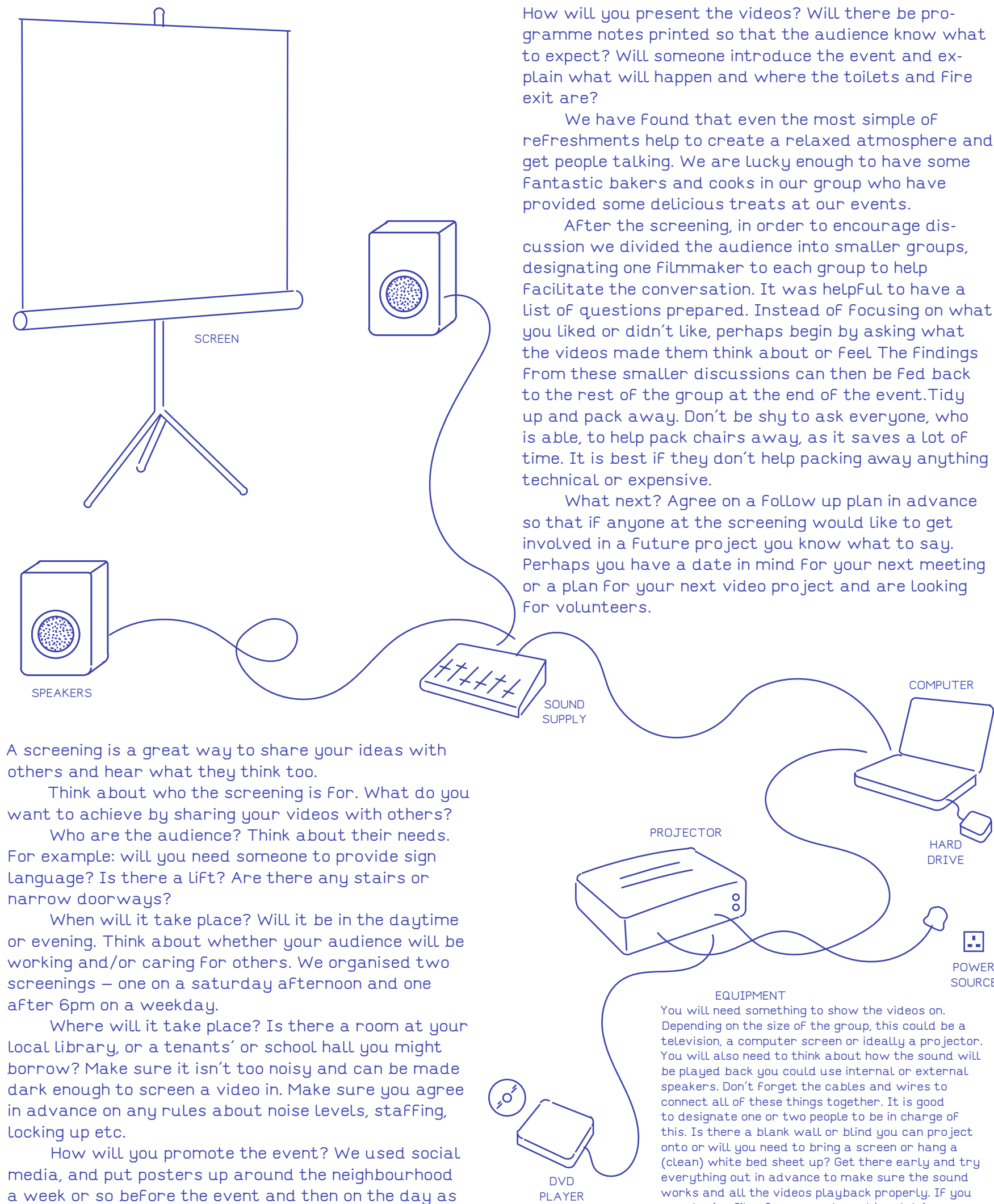

A screening is a great way to share your ideas with others and hear what they think too.

Think about who the screening is for. What do you want to achieve by sharing your videos with others?

Who are the audience? Think about their needs. For example: will you need someone to provide sign language? Is there a lift? Are there any stairs or narrow doorways?

When will it take place? Will it be in the daytime or evening. Think about whether your audience will be working and/or caring for others. We organised two screenings – one on a Saturday afternoon and one after 6pm on a weekday.

Where will it take place? Is there a room at your local library, or a tenants' or school hall you might borrow? Make sure it isn't too noisy and can be made dark enough to screen a video in. Make sure you agree in advance on any rules about noise levels, staffing, locking up etc.

How will you promote the event? We used social media, and put posters up around the neighbourhood a week or so before the event and then on the day as well. Word of mouth is one of the best ways, if you have a group of 5 people and they all bring 5 people that will be 25 people in the audience. Imagine if they then all bring 5 people...

FEEDBACK FROM PEOPLE MAKE VIDEOS

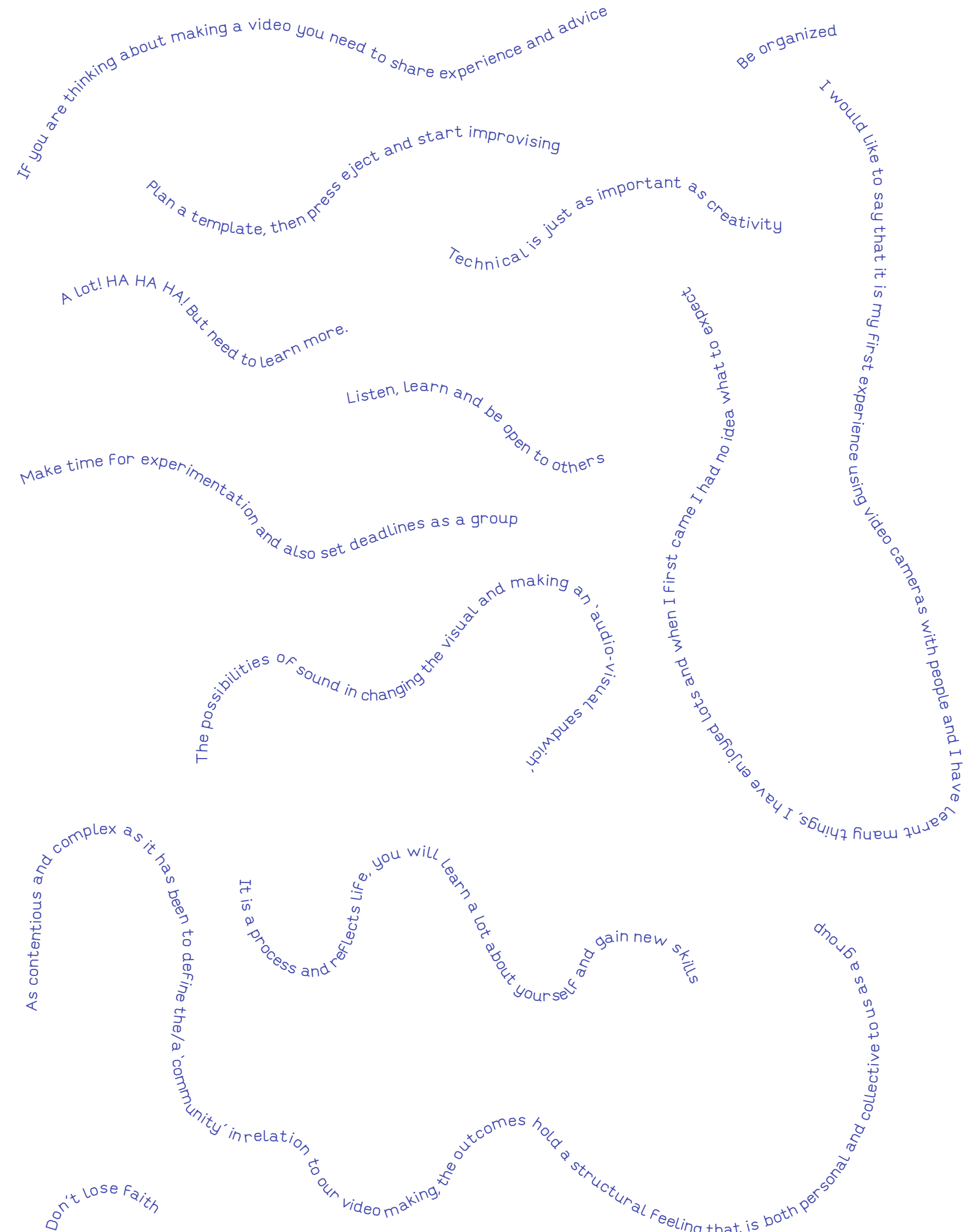

WHAT WILL IT LOOK LIKE?

WHAT WILL IT SOUND LIKE?

WHO WILL IT SPEAK FOR?

HOW WILL IT MAKE THE

AUDIENCE FEEL?

WHERE WILL IT BE SEEN?

HOW WILL IT BE

DISTRIBUTED?

WHO WILL OWN IT?

WHO WILL LOOK AFTER IT?

WHERE WILL IT BE STORED?