

**nutribullet.**  
PORTABLE BLENDER



**User guide.**

# Important safeguards.

When operating your nutribullet® Portable Blender, remember: **SAFETY COMES FIRST.**

**Warning!** To avoid the risk of serious injury or damage, carefully read all instructions before operating your nutribullet® Portable Blender. Basic safety precautions, including the following important information, should always be observed when using any electrical appliance.

If you let anyone else use your nutribullet® Portable Blender, ensure they understand the health and safety information in this User Guide and any additional safety or usage instructions. Each person using a device should completely read the User Guide to become familiar with the safe operation of the unit.

## ! Save these instructions!

### • FOR HOUSEHOLD USE ONLY

## HEAT AND PRESSURE SAFETY



**WARNING!** **DO NOT blend hot, warm, carbonated, or effervescent ingredients.**

- Such use may over-pressurize the nutribullet® Cup, causing the Cup and Motor Base to separate while operating. This may result in bodily injury from expelling

hot content or exposed blades.

- Only blend room-temperature or refrigerated ingredients (21°C/70°F or cooler).
- Carbonated and effervescent ingredients (e.g., soda, baking powder, baking soda, yeast, some batters, cake mix, dry ice, or other things that become bubbly) release gasses that increase

pressure within the Cup when blending. Some protein powders include effervescent ingredients. Always check the ingredients of all supplements before blending. **Always check all ingredients before blending.**



**WARNING!** **DO NOT blend contents for more than one minute. Do not run consecutive blending cycles that exceed one minute total.**

- Blending causes ingredients to heat up, which builds pressure in the Cup over time. Continuous blending for more than one minute may cause the Cup to separate, exposing the blade or expelling heated contents and causing injury.



**WARNING!** **DO NOT leave blended foods in a sealed cup for prolonged periods of time.**

- Blended mixtures can spoil and ferment, increasing pressure when left inside the Cup. This may cause the Cup to separate if open from the Motor Base, which may result in bodily injury from expelling hot contents or exposed blades.
- Only access the blended contents through the Sip and Carry Lid by carefully opening the Lid after blending.

## CUP CAUTION

If the Cup is hot or warm to the touch, the contents may be **HEATED** and **PRESSURIZED**. If this happens, take these steps:

- **LEAVE ALONE, DO NOT OPEN.** Leave the Cup where it is and do not touch it or allow others to touch it. **NEVER** attempt to separate the Cup from the Motor Base as this can result in bodily injury.

- Do not blend again.
- Allow the Cup to cool for at least 30 minutes. If still warm, allow for more cooling time.
- Once cool to the touch, slowly open the Lid, while pointing away from your face and body. Pour contents out into a separate vessel.

## CUP SAFETY

Proper Cup use is important to safely operate your nutribullet® Portable Blender. Using the Cup inconsistent with these instructions may result in bodily injury, property damage, or damage to your unit.

- **ALWAYS** ensure the Cup is securely locked on the Motor Base before blending. The motor will not turn on unless the Cup is situated in the locked position.
- **ONLY** operate the unit with the Lid cover in place.

- **DO NOT** exceed the MAX line. Exceeding the MAX line can result in leakage or stop page of the blade.
- **DO NOT** remove the Cup or Lid while the unit is in operation.
- **DO NOT** overfill the Cup with ice as it may stop the blades from turning resulting in damage to the unit or injury. Always use sufficient amount of liquid before blending.
- Do not use the Cup if you detect cracking, cloudiness, or other damage.
- Only order replacement parts from [nutribullet.co.uk](http://nutribullet.co.uk)

## BLADE SAFETY



**WARNING!** **Blades are sharp! Handle with care to avoid bodily injury.**

- Do not touch the sharp edges of the blades.

- Do not place hands or fingers near the blades when attaching the Cup to the Motor Base.
- Handle with care when washing the blade by hand.
- Always make sure the power is off and the charger is unplugged when assembling, disassembling, or cleaning the blade or Motor Base.
- Do not store the Motor Base with the blades exposed. Always attach the Cup to the Motor Base.



**WARNING!** **NEVER put your hands inside the cup or near the blade when the unit is running.**

- Do not remove the Cup or Lid until the blades have completely stopped. Blades can still activate when the Lid is removed. Not following these instructions may result in bodily injury,

property damage, or damage to your unit.

## BLADE CARE AND CAUTION



**WARNING!** **Discontinue use if the blade is bent or damaged.**

- Routinely inspect the blades for damage, and if detected, contact Customer Service for blade removal and replacement.
- Remove all utensils and non-food items from Cup before operating as it may result in bodily injury or damage to the blade and unit.
- Do not blend stone fruit in this appliance unless pits/seeds have been removed. Hard ingredients may damage the blade.
- The blades may stop turning if the Cup is overfilled. If this occurs, please refer to the **Errors** section in this User Guide.

## SURROUNDING SAFETY



**WARNING!** **DO NOT use your nutribullet® Portable Blender while driving, operating machinery, cycling, walking, or engaging in other activities that require your undivided attention.**

- Do not expose your nutribullet® Portable Blender to extreme temperatures, as this can cause damage to the batteries, seals, and other parts of the device.
- Do not place your nutribullet® Portable Blender on uneven or unstable surfaces.
- Do not dry your device with a hair dryer, clothes dryer, conventional oven, or microwave oven. If your device becomes wet, gently wipe the exterior with a clean, dry cloth.

- Do not use your device near water or in wet, rainy, or snowy conditions.
- Do not use your device near an open flame or other heat source; near areas of excessive dirt, dust, oil, or chemicals; or in direct sunlight.
- Do not leave your nutribullet® Portable Blender inside your vehicle, especially in the summer or winter. Prolonged exposure to extreme temperatures can cause the batteries to leak, rupture, or explode.

## GENERAL USE AND SAFETY



**WARNING!** **Failure to follow all instructions regarding your nutribullet® Portable Blender may result in serious personal injury, death, or property damage.**

- This appliance is not intended for use by

persons (including children) with reduced physical, sensory, or mental capabilities, or lack of experience and knowledge, unless they are closely supervised and instructed concerning use of the appliance by a person responsible for their safety.

Close supervision is necessary when any appliance is used by or near children. Children should be supervised to ensure that they do not play with the appliance.

- Periodically inspect your nutribullet® Portable Blender components for damage or wear that may impair proper functioning or create a safety hazard.
- Be aware of possible hazards when charging, using, or storing your nutribullet® Portable Blender.

- Do not use this blender for anything other its intended use.
- Never operate your nutribullet® Portable Blender if the Cup is empty.
- Do not attempt to defeat any safety interlock mechanisms.
- Do not insert any object other than the appropriate charger into the USB-C port. Do not allow dust to accumulate inside the port.
- Do not crush, drop, or damage the Motor Base. Do not operate if the Motor Base is damaged in any manner. Contact Customer Service for assistance by visiting [nutribullet.co.uk](http://nutribullet.co.uk)
- Use only nutribullet® attachments/ accessories specifically designed for your nutribullet® Portable Blender. Always use

genuine nutribullet® replacement parts and accessories.

Aftermarket parts are not made to nutribullet® specifications and may damage your unit or cause serious injury.

- The use of attachments including canning jars, is not recommended by the manufacturer may cause a risk or injury to persons.
- Do not attempt to clean the Motor Base by immersing in water or other cleaning liquids. Only gently wipe and dry with a clean cloth.
- Only the Cup and Lid are dishwasher safe on Top Rack without the heat or sanitize cycle. **NEVER PLACE THE MOTOR BASE IN THE DISHWASHER.**

## ELECTRICAL SAFETY



**WARNING:** **Modification, improper use, and failure to follow instructions can increase the risk of serious personal injury, death, or property damage.**

- Use only UL-listed USB sources to charge this device or a Listed/Certified ITE Power Supply or Listed Class 2 Power designed for use with power sources rated 100V AC to 240V AC at 50Hz to 60Hz. The USB charger must be listed Class 2 power supply or certified ITE power supply, rated output 5V 2A MAX. **Do not use unapproved sources.**
- To avoid the risk of electrical shock, fire or bodily injury, **DO NOT** charge or handle the unit if it is wet, or in an area that could get wet, or handle with wet hands.

- Do not use in wet conditions, or immerse the cord, plug, or Motor Base in water or other liquids.
- Do not operate with a damaged cable, Power Supply Unit/Charger, or appliance malfunction, or if or if the Motor Base has been dropped or damaged in any manner. Contact Customer Service for assistance by visiting **nutribullet.co.uk**
- Always **POWER OFF** and **UNPLUG** the nutribullet® Portable Blender when it is not in use, and **BEFORE** assembling, disassembling, changing accessories, or cleaning.
- Do not charge your device around flammable materials, on your bed or couch, or on top of any type of paper.
- Only charge your device with the power

cord that came with it. Using incompatible parts or aftermarket parts may damage your nutribullet® Portable Blender or create safety hazards that may cause personal injury or damage.

## POWER SUPPLY SAFETY



**WARNING:** **Always select and use your device's appropriate ac power supply.**

- Failure to take the following precautions can result in serious personal injury, death from electric shock or fire, or damage to your device.
- Only use a Power Supply Unit (e.g., charger, charging brick) and power cord specifically for your country's voltage.
- Do not use a wall charger with a voltage converter device or adapter.

- Do not use non-standard power sources, such as generators or inverters. Use only AC power provided by a standard wall outlet.
- Do not use a rapid charger or higher wattage charger. Use only AC power provided by a standard wall outlet or automobile lighter port. Never have the unit plugged in the automobile lighter port when starting your car to prevent possible power surge and shorting out of the unit.
- Confirm that your electrical outlet provides the type of power indicated for your nutribullet® Portable Blender (in terms of voltage [V] and frequency [Hz]). If you are unsure of the type of power supplied to your home, consult a qualified electrician.
- Do not overload your wall outlet, extension cord, power strip, or other electrical receptacles. Confirm that they are rated to handle the total current (in amps) drawn by your device (as indicated on your Power Supply Unit) and any other devices using the same circuit.
- For the Power Supply Unit where the AC prongs may be folded for storage, ensure the prongs are fully extended before plugging into an outlet.
- Never use a Power Supply Unit/Charger that is damaged, has been dropped, or received a sharp impact.
- Do not charge in an area of extreme heat or cold.
- Always unplug the Power Supply Unit/Charger when not in use.

## CABLE AND CORD SAFETY



**WARNING!** Use only the power cord that came with your nutribullet® Portable Blender to charge.

- Inspect your power cords and cables regularly.
- Exposed device cables and cords pose a potential tripping hazard. Arrange all cables and cords so that people and pets are not likely to trip over or accidentally pull on them as they move around or walk through the area.
- Do not wrap or wind the power cord too tight when storing nor bend or crease the power cord when using.
- When positioning your device or Power Supply Unit/Charger, ensure that the cords are not bent sharply and that

the connectors are not pushed against a wall or hard surface.

- Do not allow pets or children to bite or chew on cables and cords.
- When disconnecting the power cord, pull on the plug—do not pull on the cord.
- Do not let the charging cable touch hot surfaces or any extreme heat source, or become knotted, tangled, or frayed.
- Do not grab or carry your device by the charging cable or cord.
- Do not let the charging cable hang over the edge of a table or counter.

## BATTERY SAFETY

Your nutribullet® Portable Blender contains rechargeable lithium-ion batteries. **The batteries are not replaceable and must be recycled or disposed of properly.**

Opening and/or repairing or attempting to replace the batteries to your device can cause electric shock, device damage, fire, and personal injury, or property damage.

- This product contains lithium ion batteries. Dispose of your Motor Base properly. Improper disposal may result in injury, death, or property damage as a result of battery fluid leakage, fire, overheating, or explosion. Lithium ion batteries contain elements that may pose health risks to individuals if they are allowed to leach into the groundwater supply. Disposing of these batteries in standard household waste may be illegal in some countries. Please consult your local jurisdiction for proper disposal.
- Contact your local recycling or hazardous

waste disposal centers in your area for proper disposal instructions.

- Do not expose the Motor Base containing the battery pack to fire or excessive heat. Exposure to fire or temperatures above 265°F/130°C may damage the batteries and cause an explosion.
- Do not recharge your **nutribullet®** Portable Blender near a fire, heat source, or in extremely hot conditions.
- Recommended storage and ambient charging temperature: 50°F–104°F (10°C–40°C).
- Do not use your unit in any area with a potentially explosive atmosphere (e.g., fueling areas or fuel service stations, below decks on boats or other vessels, fuel and/or chemical transfer and storage facilities, and areas where flammable

chemicals or particles, such as grain dust or metal powders have collected in the air). In such areas, sparks can occur and cause an explosion or fire.

- Do not use your unit if the Motor Base is overheated, has an odor, leaks, is bulging, or changes in color/shape. Leaks from battery cells can occur under extreme conditions. Battery fluid is corrosive and may be toxic. It can cause burns and may be harmful or fatal if swallowed. Turn off immediately, discontinue use, and contact Customer Service by visiting **nutribullet.co.uk**
- **Avoid contact with battery fluid. If a battery leaks:**
  - Keep the leaked fluid from touching your skin, eyes, clothes, or other surfaces. If the battery fluid

contacts your skin, eyes, or clothes, immediately rinse the affected area with water and contact your doctor or other medical providers **as appropriate.**

- Do not use your unit in any area with a potentially explosive atmosphere, such as a cabinet above your oven or stove, near a radiator or heater, or in any area exposed to direct sunlight.
- Do not incinerate the Motor Base. The batteries can explode.

## ! Save these instructions!

To view these instructions online or in other languages, visit **nutribullet.co.uk**

# Contents.



- 16 What's included**
- 17 Assembly guide**
- 18 LED light indicator status**
  - 18 Charging
  - 19 Settings
  - 20 Errors
- 22 Using the nutribullet®  
Portable Blender**
- 24 Care and maintenance**
  - 24 Replacement parts
- 25 Recipes**

Thank you for purchasing the nutribullet® Portable Blender.

# What's included.

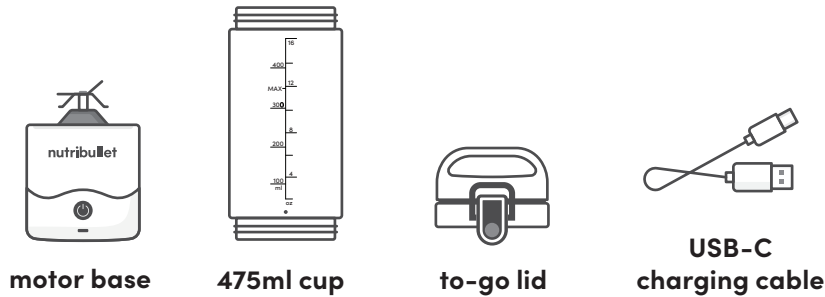

Product configurations may vary. To see our full list of nutribullet® accessories please visit [nutribullet.co.uk](http://nutribullet.co.uk)

# Assembly guide.

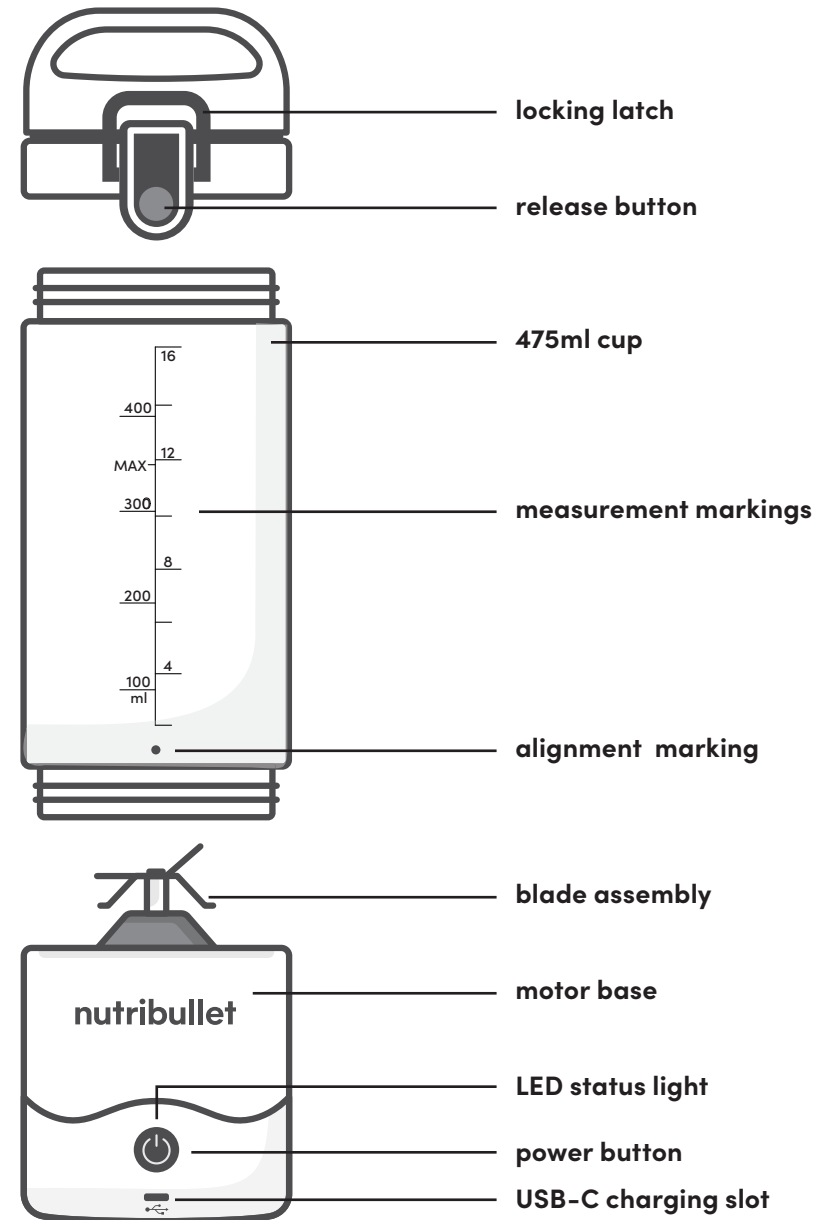

## Before first use.

### CLEAN UNIT:

See **Care and Maintenance** section on page 24.

### CHARGE UNIT:

Plug the smaller end of the included **USB-C Cable** into the slot right below the **Power** button (on the front of the **Motor Base**) and the larger end of the cable into its power source (plug adaptor, computer, etc.).

- We recommend fully charging the unit before using it for the first time. It takes 60-90 minutes to reach a full charge.

Please see **LED Status Light Indicator** section on pages 18-20.

**! WARNING!** Do not charge if your unit or the USB-C port is wet to avoid risk of fire or bodily injury.

# LED light indicator status.

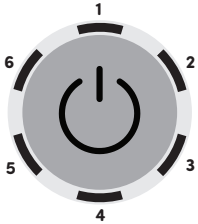

The nutribullet® Portable Blender's indicator has six LED light bars that appear red or blue according to the unit's operational status. See below for details.

## Charging.



**No power**  
All LEDs off.



**Charging**  
LEDs blink to solid blue in clockwise order.



**Low power**  
LED 1 flashes red.



**Fully charged**  
All LEDs light solid blue.

## Settings.



**Wake**  
Press button once to wake up your blender. When the ring is solid blue, you are ready to blend.



**Blend mode**  
Blue LEDs circulate clockwise. Press the **Power** button to start a 20-second cycle.

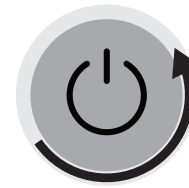

**Sleep**  
After 2 minutes of inactivity, your blender will automatically go into sleep mode. When the ring is off, the blender is off.



**Battery check**  
Press and hold the **Power** button for 2 seconds to check the battery level remaining.

## Errors.

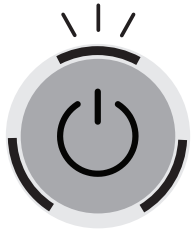

### Too many blends

Light ring will flash red, alternating between top and bottom LEDs.

**Solution:** Pause activity and allow blender to cool before next use. Don't exceed 9 blending cycles within 6 minutes.



### Overheat

Light ring will turn red.

**Solution:** Pause activity and allow blender to cool before next use.



### General error

Light ring will flash red.

### Troubleshooting:

Make sure your Cup is secured and aligned properly.

If the blade is blocked, then try the following:

- Add more liquid to the Cup and try blending again.
- Shake blender or turn upside down to remove blockage.
- Turn unit off and remove blockage from blade using a utensil.

## ⚠ WARNING!

**Before first use, review all warnings and caution statements in the important safeguards section (pages 2-13).**

**ALWAYS** make sure your blender is clean and charged before use.

Fully charge your blender before first use. The charging port is located under the light indicator of the **Motor Base**. (See the assembly section on page 17 for reference.)

**DON'T** run your nutribullet® Portable Blender when empty.

**DON'T** microwave any nutribullet® accessories.

**DON'T** leave your nutribullet® Portable Blender unattended when in use.

**DON'T** charge your nutribullet® Portable Blender if your **USB-C Cable** is wet.

**DON'T** use hot or warm ingredients in your blending cup. Heated ingredients can cause pressure to build up in the sealed cup that may expel hot contents upon opening, potentially causing personal injury or property damage.

**NEVER** run the nutribullet® Portable Blender for more than one minute at a time, as it can cause permanent damage to the motor. If the motor stops working, pause activity and allow the blender to cool. Your nutribullet® Portable Blender has an internal thermal breaker that shuts the unit off when it overheats. Letting the thermal breaker cool down should allow it to reset.

**ALWAYS** inspect your blade. During the warranty period, contact Customer Service before removing the blade for safety instructions and replacement.

# Using the nutribullet® Portable Blender.

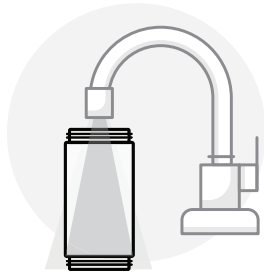

- 1 Clean **Blending Cups** with hot, soapy water before use.

**NOTE:** You can also clean your blender by adding cold water and a drop of soap to the **Cup** and blending for one cycle.



- 3 Twist off the **Lid** and add your ingredients.

**WARNING!** For best performance, do not exceed the **MAX** line, do not overfill, and use sufficient liquid ingredients.

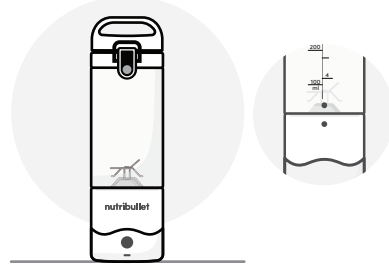

- 2 Place the **nutribullet® Portable Blender** on a clean, dry, and level surface.

**NOTE:** Ensure the **Cup** is positioned properly by aligning the two dots located on the **Cup** and **Motor Base**.

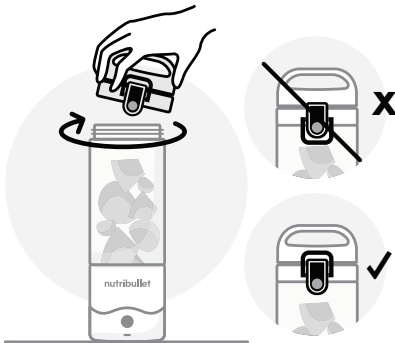

- 4 Twist the **Lid** back onto the **Cup**.

**NOTE:** Make sure the **Lid Latch** is upright in the locked position.



- 5 Wake up your blender by pressing the **Power** button once. Wait about 1 second for the light animation to complete.

**NOTE:** After 2 minutes of inactivity, your blender will automatically go into **Sleep Mode**. This prevents accidental blends and preserves battery life.



- 6 Once your blender is awake, press the **Power** button again to start a 20-second blend cycle.

If you want to **Pulse** your ingredients or stop your blend cycle early, press the **Power** button again to stop.

**WARNING!** Do not blend for longer than one minute to avoid excessive heat and pressure build-up. For repeat cycle, carefully open the container to release any built-up pressure before blending again.

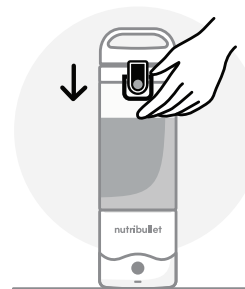

- 7 Once blending is complete, flip the latch down to unlock the **Lid Latch**.

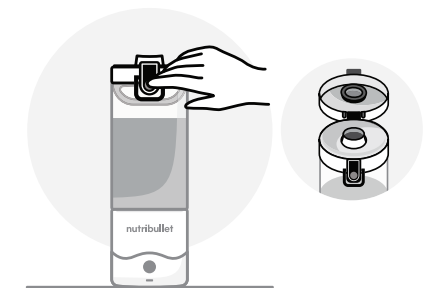

- 8 Press the button on the **Lid** to open and reveal the spout. Enjoy!

# Care & maintenance.

## STEP 1:

Always make sure the nutribullet® Portable Blender is turned off after each use.

## STEP 2:

Hand-wash the Cup and Lid with warm, soapy water and rinse clean:

**NOTE:** The Motor Base is **NOT** dishwasher safe. However, the Cup and Lid can be washed in the top rack of your dishwasher without the heat or sanitize cycle.

## STEP 3:

Gently rinse the blade assembly and wipe with a damp sponge or cloth.

**NOTE:** Never submerge or run the Motor Base under water.

 **WARNING! Do not touch blades! They are very sharp.**

 **WARNING! Do not blend hot or warm liquids in the 475ml Cup.**

 **WARNING! Never submerge the Motor Base into water or any other liquid.**

## STEP 4:

Always store your nutribullet® Portable Blender in a safe place, upright with the Cup attached, so that the blades are covered and not exposed. Do not stack any objects on top of the unit while storing.

---

## Replacement parts.

To order additional parts and accessories, please visit our website at [nutribullet.co.uk](https://nutribullet.co.uk)

# nutribullet® Portable Blender recipe guide.

## Life is complicated. Eating healthy doesn't have to be.

Great blends, wherever life takes you. That's what nutribullet® Portable Blender is all about. This lightweight appliance lets you mix all your favorite blends without the use of a cord or plug. Just charge it up, take it on-the-go, and start it up when it's time to get down to business.

Whether you're craving a post-workout protein shake, a healthy snack on the road, or a fun and festive poolside cocktail, this handy blender makes it all, wherever you happen to be. Its USB-C charger fuels the motor for roughly 15+ blending cycles and its handled lid makes it easy to transport on all your adventures.

To get you started, we've compiled this collection of simple, easy, and delicious recipes, from lattes to smoothies to dips and dressings. Take a look, blend your favorites, and get going on your simple and delicious way.

We can't wait to see you out there.

# Iced golden latte.

## MAKES 1 SERVING

Go for the gold with this cold and creamy latte, filled with warm and tasty spices known for their anti-inflammatory and antioxidant benefits.

240 ML	<b>UNSWEETENED OAT MILK</b>	1 Add all ingredients in the order listed to the <b>Cup</b> .
25 ML	<b>AGAVE</b>	2 Twist on the <b>Lid</b> and blend for the full cycle.
2	<b>GINGER ROOT, PEELED &amp; THINLY SLICED</b>	
6.8 G	<b>GROUND TURMERIC</b>	
PINCH	<b>CRACKED BLACK PEPPER</b>	
.7 G	<b>GROUND CINNAMON</b>	
108 G	<b>ICE</b>	

## NUTRITION FACTS PER 300 ML SERVING

170 calories, 1.5g fat, 38g carbs, 3g fiber, 16g sugar, 2g protein.

# Iced matcha latte.

## MAKES 1 SERVING

Too much matcha? No such thing. We can't get enough of its potent green tea goodness, especially when blended to perfection in a creamy frozen latte.

240 ML	<b>UNSWEETENED OAT MILK</b>	1 Add all ingredients in the order listed to the <b>Cup</b> .
25 ML	<b>AGAVE</b>	2 Twist on the <b>Lid</b> and blend for the full cycle.
4 G	<b>MATCHA POWDER</b>	
108 G	<b>ICE</b>	

## NUTRITION FACTS PER 300 ML SERVING

190 calories, 2g fat, 39g carbs, 5g fiber, 16g sugar, 5g protein.

# Peanut butter banana smoothie.

## MAKES 1 SERVING

This rich and creamy smoothie is delicious enough to enjoy for dessert, and nutritious enough to make any time of day.

240 ML	<b>UNSWEETENED VANILLA ALMOND MILK</b>	1 Add all ingredients in the order listed to the <b>Cup</b> .
15 ML	<b>MAPLE SYRUP</b>	2 Twist on the <b>Lid</b> and blend for the full cycle.
½	<b>BANANA</b>	
16 G	<b>PEANUT BUTTER</b>	
6.25 G	<b>UNSWEETENED CACAO POWDER</b>	
108 G	<b>ICE</b>	

## NUTRITION FACTS PER 350 ML SERVING

260 calories, 13g fat, 33g carbs, 5g fiber, 21g sugar, 6g protein.

# Orange creamsicle smoothie.

## MAKES 1 SERVING

Creamy coconut milk, sweet and tangy orange, mellow banana...there's nothing not to love in this sweetly dreamy smoothie.

200 ML	<b>COCONUT MILK, CANNED</b>	1 Add all ingredients except ice to the <b>Cup</b> in the order listed.
2.5 ML	<b>ORANGE EXTRACT</b>	2 Twist on the <b>Lid</b> and blend for one cycle.
1.25 ML	<b>VANILLA EXTRACT</b>	
5 ML	<b>MAPLE SYRUP</b>	3 Twist off the <b>Lid</b> and add the ice to the <b>Cup</b> . Twist the <b>Lid</b> back on and blend for a second cycle.
½	<b>ORANGE, CUT IN 2 PIECES</b>	
½	<b>BANANA</b>	
50 G	<b>ICE</b>	

## NUTRITION FACTS PER 300 ML SERVING

350 calories, 24g fat, 30g carbs, 4g fiber, 20g sugar, 3g protein.

# Strawberry banana smoothie.

## MAKES 1 SERVING

When you're craving a classic, this smoothie delivers. Add in a scoop of chia seeds for an extra boost of fiber and Omega-3's, and a splash of vanilla extract to make it sing. Bottom's up!

120 ML	<b>UNSWEETENED VANILLA ALMOND MILK</b>	1 Add all ingredients in the order listed to the <b>Cup</b> .
2.5 ML	<b>VANILLA EXTRACT</b>	2 Twist on the <b>Lid</b> and blend for the full cycle.
100 G	<b>STRAWBERRIES, FRESH</b>	
½	<b>BANANA</b>	
15 G	<b>CHIA SEEDS</b>	
108 G	<b>ICE</b>	

### NUTRITION FACTS PER 350 ML SERVING

170 calories, 5g fat, 28g carbs, 8g fiber, 13g sugar, 4g protein.

# Mango margarita.

## MAKES 1 SERVING

Frozen mango gives the classic margarita a sweet and frosty twist. Garnish your glass with some chili salt to bring in a full spectrum of festive flavors.

30 ML	<b>LIME JUICE</b>	1 Add all ingredients in the order listed to the <b>Cup</b> . 2 Twist on the <b>Lid</b> and blend for the full cycle. 3 <b>If desired, rim a drinking glass with Tajin:</b> rub the lime wedge around the rim, then dip in Tajin to coat. Transfer the smoothie into the glass.
74 ML	<b>TEQUILA</b>	
30 ML	<b>TRIPLE SEC</b>	
15 ML	<b>AGAVE</b>	
140 G	<b>FROZEN MANGO, THAWED FOR 10 MINUTES</b>	
PINCH	<b>SALT</b>	
1	<b>LIME WEDGE, FOR GARNISH</b>	
	<b>TAJIN, TO GARNISH</b>	

### NUTRITION FACTS PER 177 ML SERVING

190 calories, 0g fat, 26g carbs, 2g fiber, 22g sugar, 0g protein.

# Pancakes.

## MAKES 2 SERVINGS

These fluffy oat flour pancakes make a deliciously wholesome addition to any breakfast spread.

120 ML	<b>UNSWEETENED ALMOND MILK</b>	1 Add oats to the <b>Cup</b> .
2.5 ML	<b>VANILLA EXTRACT</b>	2 Twist on the <b>Lid</b> and run for one cycle to yield oat flour.
45 G	<b>ROLLED OATS</b>	3 After the oats have been grounded, twist off the <b>Lid</b> and add the remaining ingredients to the <b>Cup</b> in the order listed.
½	<b>BANANA</b>	
9 G	<b>FLAXSEED</b>	
1.3 G	<b>CINNAMON</b>	
PINCH	<b>SALT</b>	4 Twist the <b>Lid</b> back on and blend. Shake if needed to distribute ingredients and blend again.

### NUTRITION FACTS PER

#### 270 G SERVING, MAKES 4 PANCAKES

220 calories, 6g fat, 35g carbs, 7g fiber, 5g sugar, 8g protein.

# Salsa.

## MAKES 8 SERVINGS

Fresh salsa comes together in a snap with this super easy and tasty mix of tomato, pepper, onion, and garlic.

120 G	<b>DICED TOMATOES WITH JUICE, CANNED</b>	1 Add all ingredients in the order listed to the <b>Cup</b> .
100 G	<b>RED BELL PEPPER, CHOPPED</b>	2 Twist on the <b>Lid</b> and <b>PULSE</b> until desired consistency.
13 G	<b>ONION, CHOPPED</b>	
2	<b>GARLIC CLOVES</b>	
.9 G	<b>CRUSHED RED PEPPER FLAKES</b>	
2.8 G	<b>SALT</b>	
1 G	<b>BLACK PEPPER</b>	

### NUTRITION FACTS PER

#### 36 G SERVING

5 calories, 0g fat, 1g carbs, 0g fiber, <1g sugar, 0g protein.

# Cucumber dill dressing.

## MAKES 8 SERVINGS

This creamy dressing adds fresh, zesty flavor to pretty much everything, from salads to grain bowls, to falafel.

82 G	<b>WHOLE MILK GREEK YOGURT</b>	1 Add all ingredients to the <b>Cup</b> in the order listed.
15 ML	<b>LEMON JUICE</b>	2 Twist on the <b>Lid</b> and run a full blend cycle. Run a second time, if needed.
35 G	<b>PERSIAN CUCUMBERS, SLICED</b>	
2.4 G	<b>SALT</b>	
3.6 G	<b>ONION POWDER</b>	
3-5	<b>SPRIGS OF FRESH DILL</b>	
4	<b>MINT LEAVES</b>	

### NUTRITION FACTS PER 30 G SERVING

30 calories, 1.5g fat, 2g carbs, 0g fiber, 1g sugar, 3g protein.

# Raspberry vinaigrette.

## MAKES 8 SERVINGS,

A delightfully tangy dressing that's perfect for sprucing up any mix of fresh greens.

120 ML	<b>EXTRA VIRGIN OLIVE OIL</b>	1 Add all ingredients in the order listed to the <b>Cup</b> .
15 ML	<b>APPLE CIDER VINEGAR</b>	2 Twist on the <b>Lid</b> and blend for the full cycle.
30 ML	<b>RED WINE VINEGAR</b>	
62 G	<b>RASPBERRIES, FRESH</b>	
1	<b>GARLIC CLOVE, HALVED</b>	
2.8 G	<b>GROUND MUSTARD</b>	
1.2 G	<b>SALT</b>	

### NUTRITION FACTS PER 30 ML SERVING

130 calories, 14g fat, 1g carbs, <1g fiber, 0g sugar, 0g protein.

**nutribullet**

**Need help?  
We're here  
for you**

Visit  
**nutribullet.co.uk** for:



FAQ'S



More Recipes



Register your product

Join our community



#### Explanation of the marking



This marking indicates that this product should not be disposed with other household wastes throughout the EU. To prevent possible harm to the environment or human health from uncontrolled waste disposal; recycle it responsibly to promote the sustainable reuse of material resources. To return your used device, please use the return and collection systems or contact the retailer where the product was purchased. They can take this product for environmental safe recycling



The transport and protective packing has been selected from materials, which are environmentally friendly for disposal and can be recycled. Ensure that any plastic, wrappings, bags etc. are disposed of safely and kept out of the reach of babies and young children. Rather than just throwing these materials away, recycle them



A Class II or double insulated electrical appliance is one which has been designed in such a way that it does not require a safety connection to electrical earth (ground).



Manufacturer's declaration that product meets the requirements of the applicable UK regulations



**Capital Brands Distribution, LLC |All rights reserved.**

nutribullet® Portable Blender is the trademark of CapBran Holdings, LLC registered in the U.S.A. and worldwide.

Illustrations may differ from the actual product. We are constantly striving to improve our products, therefore the specifications contained herein are subject to change without notice.

**240221\_NB09350**