



USER GUIDE

STOVES RICHMOND DX 90CM ELECTRIC
INDUCTION

Table Of Contents

INTRODUCTION	1
COUNTRIES OF DESTINATION:	1
CONTACT INFORMATION:	1
EUROPEAN DIRECTIVES	2
DISPOSAL OF PACKAGING MATERIAL	2
SAFETY & WARNING INFORMATION	3
CAUTION INFORMATION	5
ELECTROMAGNETIC INTERFERENCE	7
FIRE SAFETY ADVICE	7
GETTING TO KNOW YOUR PRODUCT	9
CONTROL PANEL	9
COMPARTMENT OVERVIEW	11
HOB (ROTARY CONTROLS)	11
INDUCTION DIAL (Rotary Only)	12
OVERVIEW OF THE MAIN MULTI-FUNCTION OVEN	12
MAIN OVEN FUNCTIONS	12
OVERVIEW OF THE TOP OVEN/GRILL	13
GRILL FUNCTIONS IN THE TOP OVEN	13
USING THE INDUCTION HOB (ROTARY CONTROLS)	14
AUTO POWER TUNING	14
SWITCHING AN INDUCTION ZONE ON AND OFF, AND SELECTING A POWER LEVEL	14
USING THE AUTOMATIC BOIL AND SIMMER FUNCTION	14
USING THE KEEP WARM FUNCTIONS	15
USING THE MELTING CHOCOLATE FUNCTION (KEEP WARM FUNCTION 1)	15
USING THE WARMING FUNCTION (KEEP WARM FUNCTION 2)	15
USING THE RAPID SIMMER FUNCTION (KEEP WARM FUNCTION 3)	16
USING THE POWER BOOST FUNCTION	16
USING THE BRIDGING FUNCTION	17
ACTIVATING AND DEACTIVATING THE CHILD LOCK	17
ADDITIONAL INFORMATION ABOUT THE ROTARY INDUCTION HOB	18
AUTO POWER TUNING	18
IDLE MODE	18
PAN DETECTION SYSTEM	18

RESIDUAL HEAT INDICATORS	18
AUTO STAND BY	18
POWER MANAGEMENT SYSTEM	19
OVERHEATING PROTECTION SYSTEM	19
INDUCTION DISPLAY SYMBOLS (Rotary Models)	20
OVENS & GRILLS	22
USING THE GRILL	23
GRILL PAN AND TRIVET	24
USING THE TOP OVEN	25
USING THE MAIN OVEN	27
MAIN OVEN COOKING FUNCTIONS EXPLAINED	31
OVEN FURNITURE	35
USING THE TALL FANNED OVEN WITH PRO-FLEX™	
SPLITTER	36
USING OTHER ACCESSORIES	41
CLOCK/PROGRAMMER	43
USING THE TOUCH CONTROLS	44
MANUAL MODE	44
SETTING THE TIME OF DAY	44
SETTING TIMERS	45
ACTIVATING AND DEACTIVATING THE TIMER CHILD	
LOCK	49
ACTIVATING AND DEACTIVATING THE TIMER	
DEMONSTRATION MODE (FOR SHOWROOMS ONLY)	49
CLEANING YOUR APPLIANCE	51
STEAM ASSISTED CLEANING	52
CLEANING AND CARE GUIDANCE	53
APPLIANCE MAINTENANCE	56
CHANGING THE LIGHTBULB	56
OVEN SHELVES	56
REMOVING AND REPLACING SHELF GUIDES	57
REPOSITIONING THE PRO-TRAC™ TELESCOPIC SLIDERS ..	58
REMOVING THE SLIDERS	58
CHOOSING A SUITABLE POSITION FOR THE	
SLIDERS	59
IDENTIFYING THE SLIDERS	59

INSTALLING THE SLIDERS	59
INSTALLING A SHELF, AIR FRY TRAY OR FULL-WIDTH GRILL-PAN ON THE SLIDERS	60
ORDERING ADDITIONAL PAIRS OF SLIDERS	61
REMOVING AND RE-FITTING CONTROL KNOBS, SPRINGS AND BEZELS	61
FAQs	63
KEY PARTS AND OPTIONAL ACCESSORIES	64
LOCATING THE MODEL AND SERIAL NUMBERS	67
TECHNICAL DATA	68
ENERGY DATA TABLE	69
SERVICE CONTACT DETAILS	71

INTRODUCTION

Congratulations and thank you for purchasing your new Stoves range cooker. We hope you will enjoy many years of excellent cooking performance and service.

This user guide is designed to help you to care for and get the best out of your new product.

Please read it carefully before you start using your appliance, as we have endeavoured to answer as many questions as possible and provide you with as much support as we can.

General information, spares and service information is available from our website.

If you should find something missing from your product or have any questions that are not covered in this user guide, please contact us (see contact information on the back cover).

COUNTRIES OF DESTINATION:

GB- Great Britain	✓
IE - Ireland	✓
DE - Germany	
FR - France	
PL - Poland	
NL - Netherlands	
SE - Sweden	
NZ - New Zealand	
AU - Australia	

CONTACT INFORMATION:

Customer Care Helpline:

0344 815 3740

Alternatively, use the contact form on our website

www.stoves.co.uk

Details about warranty registration and spares & service information are also available on our website.

Calls are charged at the basic rate, please check with your telephone service provider for exact charges.

Your new appliance comes with our FREE 3 year guarantee (UK only), protecting you against electrical and mechanical breakdown.

To register your new appliance for its warranty (UK only) please visit our website www.stoves.co.uk. For full terms & conditions of the manufacturer's guarantee, please refer to the website above.

In addition, you may wish to purchase an extended warranty. Details of how to do this are also on our website www.stoves.co.uk.

Our policy is one of constant development and improvement, therefore we cannot guarantee the strict accuracy of all of our illustrations and specifications. Changes may have been made subsequent to publishing.

Glen Dimplex Home Appliances,
Element, Temple Court, Risley,
Warrington, WA3 6GD.

EUROPEAN DIRECTIVES

As a producer and a supplier of cooking appliances we are committed to the protection of the environment and are in compliance with the WEEE directive.

All our electric products are labelled accordingly with the crossed out wheeled bin symbol. This indicates, for disposal purposes at the end of their working life, that these products must be taken to a recognized collection point, such as local authority sites/local recycling centres.

This appliance complies with European Community Directives (CE) for household and similar electrical appliances and Gas appliances where applicable.

This appliance conforms to European Directive regarding Eco design requirements for energy-related products. Our policy is one of constant development and improvement, therefore we cannot guarantee the strict accuracy of all of our illustrations and specifications - changes may have been made subsequent to publishing.

DISPOSAL OF PACKAGING MATERIAL

DISPOSAL OF PACKAGING MATERIAL	
	<p>The packaging materials used with this appliance can be recycled. Please dispose of the packaging materials in the appropriate container at your local waste disposal facility.</p>

SAFETY & WARNING INFORMATION



WARNING

We strongly recommend that this appliance is connected by a competent person who is a member of a 'Competent Person Scheme', who will comply with the required regulations.



WARNING

This appliance can be used by children aged from 8 years and above and persons with reduced physical, sensory or mental capabilities or lack of experience and knowledge if they have been given supervision or instruction concerning use of the appliance in a safe way and understand the hazards involved. Children shall not play with the appliance. Cleaning and user maintenance shall not be made by children without supervision.



WARNING

If the hob glass surface is cracked, switch off the appliance to avoid the possibility of electric shock.



WARNING

During use the appliance becomes hot. Care should be taken to avoid touching heating elements inside the oven.



WARNING

The appliance and its accessible parts become hot during use. Care should be taken to avoid touching heating elements. Children less than 8 years of age shall be kept away unless continuously supervised.



WARNING

The oven must be switched off before removing the guard and, after cleaning, the guard must be replaced in accordance with the instructions.



WARNING

A steam cleaner is not to be used on this appliance.

**WARNING**

Metallic objects such as knives, forks, spoons and lids should not be placed on the hob surface since they can get hot.

**WARNING**

Ensure the appliance is switched off before replacing the lamp to avoid the possibility of electric shock.

**WARNING**

Unattended cooking on a hob with fat or oil can be dangerous and may result in fire.

Danger of fire: NEVER try to extinguish a fire with water, but switch off the appliance and then cover the flames e.g. with a lid or a fire blanket.

**WARNING**

Danger of fire: do not store items on the cooking surfaces. Do not place articles on or against the appliance.

**WARNING**

Use only hob guards designed by the manufacturer of the cooking appliance or indicated by the manufacturer of the appliance in the instructions for use as suitable or hob guards incorporated into the appliance. The use of inappropriate guards can cause accidents.

**WARNING**

Never place food, or dishes on the base of the oven cavities; there may be elements there which will cause overheating.

**WARNING**

The appliance must never be disconnected from the mains electricity supply during use, as this will seriously affect the safety and performance, particularly in relation to surface temperatures becoming hot and gas operated parts not working effectively. The cooling fan is designed to run on after the control knob has been switched off.

**WARNING**

Do not store flammable liquids or items in the vicinity of this appliance.

**WARNING**

Do not modify this appliance.

**WARNING**

Do not operate the appliance without the glass door panels correctly fitted.

**WARNING**

Accessible parts may become hot when the grill is in use. Children should be kept away.

**WARNING**

If a lid is fitted to your appliance any spillage should be removed from the lid before opening and the hob surface should be allowed to cool before closing the lid.

**WARNING**

This appliance must be earthed.

**WARNING**

Never use cooking vessels on the hob that overlap its edges.

CAUTION INFORMATION

**CAUTION**

In order to avoid a hazard due to inadvertent resetting of the thermal cut-out, this appliance must not be supplied through an external switching device, such as a timer, or connected to a circuit that is regularly switched on and off by the utility.

**CAUTION**

Do not use harsh abrasive cleaners or sharp metal scrapers to clean the oven door glass / the hob surface / the glass of hinged lids (as appropriate), since they can scratch the surface, which may result in the shattering of the glass.

**CAUTION**

Only use the temperature probe recommended for this oven.

**CAUTION**

Do not stare at the hob elements.

**CAUTION**

After use, switch off the hob element by its control and do not rely on the pan detector on induction hobs.

**CAUTION**

This appliance is not intended to be operated by means of an external timer or separate remote control system.

**CAUTION**

The cooking process must be supervised. A short-term cooking process has to be supervised continuously.

**CAUTION**

Accessible parts may be hot when the grill and/or the oven are in use. Young children shall be kept away.

**CAUTION**

Our policy is one of constant development and improvement, therefore we cannot guarantee the strict accuracy of all our illustrations and specifications. Changes may have been made subsequent to publishing.

**CAUTION**

Make sure that you have removed all packaging and wrapping. Some of the items inside this appliance may have additional wrapping. It is recommended that you wash the oven shelves, air fry tray, grill pan and grill pan trivet before their first use in hot soapy water. This will remove the protective oil coating. It is recommended that you turn the ovens and/or grill on for a short while. This will burn off any residues left from manufacturing. There may be a smell which accompanies this process - but this is nothing to worry about and is harmless.

**CAUTION**

This appliance is for cooking purposes only. It must not be used for other purposes, for example room heating.

**CAUTION**

Electrical connection should be made with a suitable flexible cable which can withstand a temperature rise of at least 70°C. Ensure that you route all mains cables well clear of any adjacent heat source.



CAUTION

We recommend that the appliance is connected by a competent person who is a member of a 'Competent Person Scheme' who will comply with the required regulations.



CAUTION

The space of air circulation, located underneath and at the back of the hob improves the reliability of the cooling fan by ensuring that it will cool down the appliance efficiently.

- Please read the following carefully:

ELECTROMAGNETIC INTERFERENCE

The functions of the hob comply with the applicable standard on electromagnetic interference.

Your induction cooking hob thus complies fully with the statutory requirements (Directive 2004/108/EC). It is designed to not interfere with the functioning of other electrical equipment as long as these also comply with the same regulations.

Your induction hob generates magnetic fields in its immediate vicinity.

So that there is no interference between your cooking hob and a pacemaker, the pacemaker must be designed in compliance with the appropriate regulations.

In this respect we can only guarantee the compliance of our own product. You can ask the pacemaker manufacturer or your doctor about the compliance or any incompatibilities of your pacemaker.

FIRE SAFETY ADVICE

- If you do have a fire in the kitchen, don't take any risks- get everyone out of your home and call the Fire Brigade.
- If a pan catches fire:
 - Do not move it- it is likely to be extremely hot.
 - Turn off the heat if it's safe to do so- but never lean over the pan to reach the controls.
 - If you have a fire blanket, put it out over the pan. If you have put the fire out, leave the pan to cool completely.
- Deep-fat frying presents more dangers in your kitchen.
 - Never fill a chip pan (or other deep fat fryer) more than one-third full of oil.
 - Do not use a fire extinguisher on a pan of oil - the force of the extinguisher can spread the fire and create a fireball.
- If you have an electrical fire in the kitchen:
 - Pull the plug out, or switch off the power at the fuse box - this may be enough to stop the fire immediately
 - Smother the fire with a fire blanket, or use a dry powder or carbon dioxide extinguisher
 - Remember: never use water on an electrical or cooking oil fire.

OTHER SAFETY ADVICE

- DO



- **Always take care removing food from the oven as the area around the cavity may be hot.**
- **Always use oven gloves when handling any cookware that has been in the oven as it will be hot.**
- **Always make sure that the oven shelves are resting in the correct position between two runners.**
- **Always use the Minute Minder (if fitted) to remind you when to check the food, if you are leaving the oven unattended - this reduces the risk of food burning.**
- **DO NOT**
 - **Never place items on the door while it is open.**
 - **Never wrap foil around the oven shelves or allow foil to block the flue.**
 - **Never drape tea towels near the oven while it is on; this will cause a fire hazard.**
 - **Never pull heavy items, such as turkeys or large joints of meat, out from the oven shelf, as they may overbalance and fall.**
 - **Never use this appliance to heat anything other than food items and do not use it for heating the room.**



GETTING TO KNOW YOUR PRODUCT



IMPORTANT

If the clock/programmer is locked, it must be unlocked before the main multi-function oven can be used.

To unlock the clock/programmer press and hold the central clock key  for 5-10 seconds, until the padlock symbol  disappears.

To lock the clock/programmer press and hold the central clock key  for 5-10 seconds, until the padlock symbol  appears.

Your appliance layout may differ depending on the model.

CONTROL PANEL

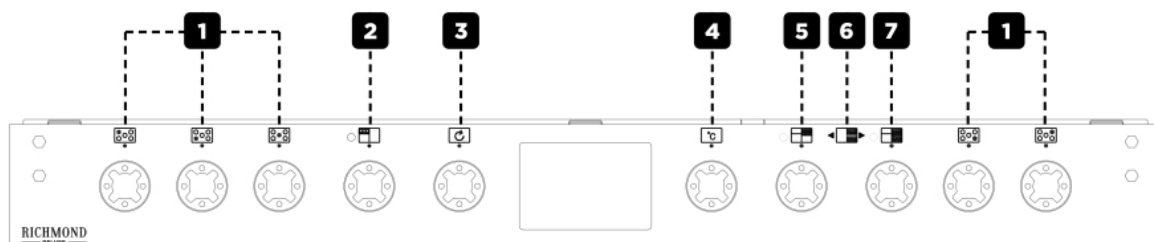

1	Hob Cooking Zone controls
2	Top Oven / Grill control
3	Multi-function oven function selector - used in conjunction with 4
4	Multi-function oven temperature control - used in conjunction with 3
5	Tall Oven upper section temperature control - used with the oven splitter
6	Oven splitter symbol

COMPARTMENT OVERVIEW

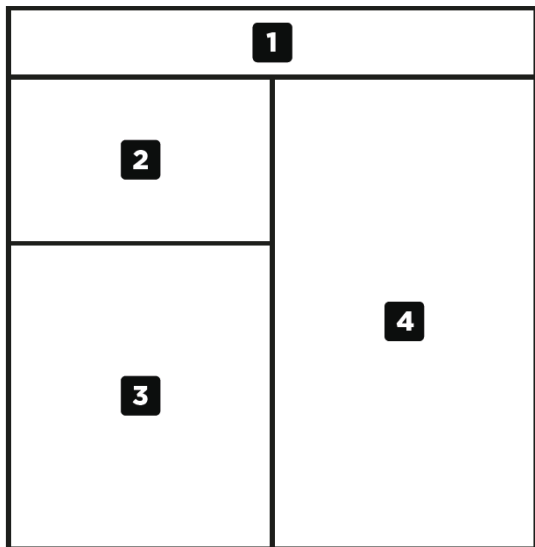

CAVITY OVERVIEW	
1	Fascia - control panel
2	Top Oven/Grill
3	Multi-function Oven - main oven which can be controlled by the timer
4	Tall Pro-Flex™ Oven - can be used as one large tall fanned oven, two separate fanned ovens, or one smaller fanned oven

HOB (ROTARY CONTROLS)

Deluxe models only

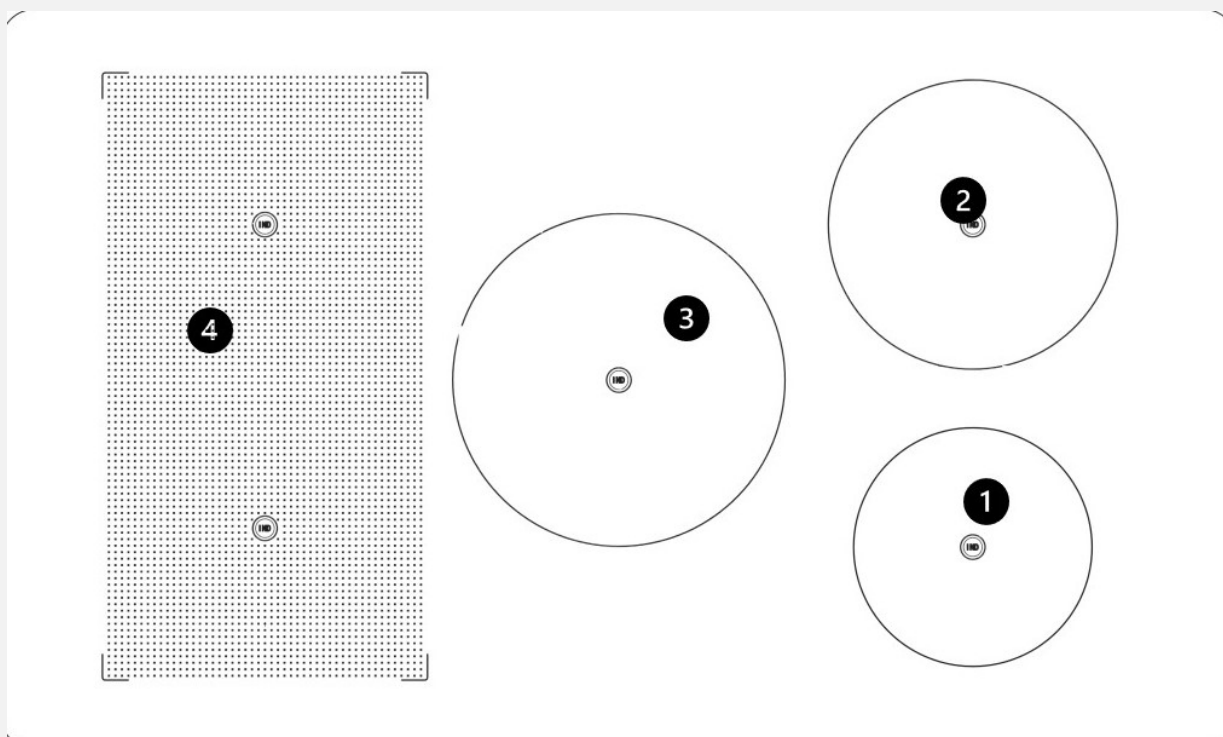

HOB FUNCTIONS		
1	Small - 160mm diameter - smallest recommended pan base diameter is 120mm	Front-right
2	Medium - 200mm diameter - smallest recommended pan base diameter is 145mm	Back-right
3	Large - 230mm diameter - smallest recommended pan base diameter is 145mm	Centre

4	Bridged Induction Zone - can be used as two separate medium zones or as one larger zone - 2 x 200mm diameter - smallest recommended pan base diameter is 145mm per zone.	Left hand side
---	---	----------------

Pans must have a smooth, flat, magnetic base. Generally, induction hobs cannot recognise pans with smaller base diameters than 120mm.

INDUCTION DIAL (Rotary Only)

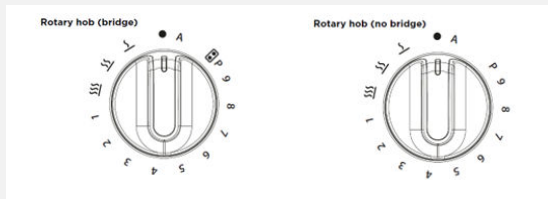





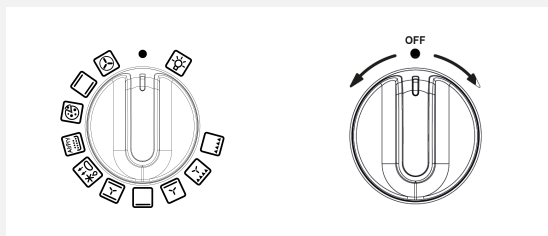



The control knobs for the front-left zone and the back-left zone include the bridging function symbol .



OVERVIEW OF THE MAIN MULTI-FUNCTION OVEN





Select a cooking function with the control knob to the left of the timer screen. Select a cooking temperature using the control knob to the right of the timer screen.

MAIN OVEN FUNCTIONS

Fanned Oven - use any shelf position; can bake on two or more levels simultaneously.	
Conventional Oven - place the food in the middle shelf position.	
Pizza Setting - place the pizza in the middle shelf position.	
Air Fryer - place the air-fry tray in the middle shelf position, and place the grill pan below to catch any drips or food particles. Please note cooking times will be a bit longer compared to a work-top air fryer because of the larger cooking capacity.	
Defrost/Dough proving - leave the temperature control in the off position. Use with the door closed for defrosting and dough proving. Use with the door open for cooling cooked food prior to refrigerating.	
Intensive Bake - fan-assisted oven - place the food in the middle shelf position - good for baking quiche, bread, cheesecakes, pies and pizzas.	
Top Heat - place the food in the middle shelf position - used towards the end of cooking to brown dishes like shepherd's pie, lasagne, cauliflower cheese, etc.	
Base Heat with Fan - place the food in the middle shelf position - used for baking open pies and tarts, or baking pastry cases, etc.	
Fanned Grill - used for grilling thicker meats like sausages or chicken pieces - use a medium-to-high shelf position, ensuring that the food is clear of the upper grill element - use with the door closed - level 1=low	

heat, level 2=medium heat, level 3=high heat.	
Conventional Grill - used for toasting bread and grilling thinner meats, like bacon - use a medium-to-high shelf position, ensuring that the food is clear of the upper grill element - use with the door closed - level 1=low heat, level 2=medium heat, level 3=high heat.	
Light Only - puts the oven light on without putting the heat on - useful when wiping round the oven cavity.	

GRILL FUNCTIONS IN THE TOP OVEN

Full-width grill - high heat - use with the door open	
Central part of grill comes on - high heat - use with the door open	
Browning function - low heat - use with the door open	

OVERVIEW OF THE TOP OVEN/GRILL

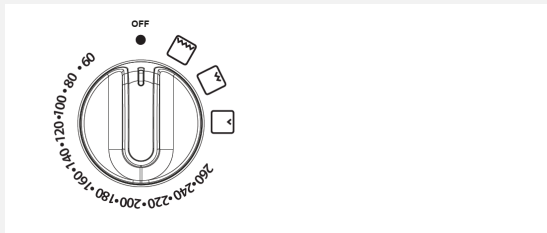

- When using the top oven as a conventional oven, with the door closed, turn the top oven/grill control knob to the required temperature.
- Pre-heat for 15 minutes for best results and use a middle shelf position.
- When using the top oven as a grill, with the door open, turn the top oven/grill control knob to the required grill setting.
- Pre-heat for 3 to 5 minutes for best results.

USING THE INDUCTION HOB (ROTARY CONTROLS)

- The induction hob provides the most energy-efficient hob technology available.
- The induction system provides superior heat up and cool down times for pans - you get fast, precise, repeatable power control.
- As induction only heats up the pan, there is no wasted energy from the cooking process, which in turn, limits the heat generated in the kitchen.

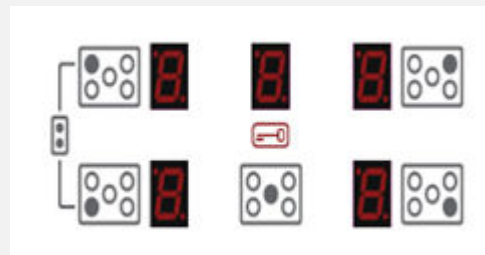
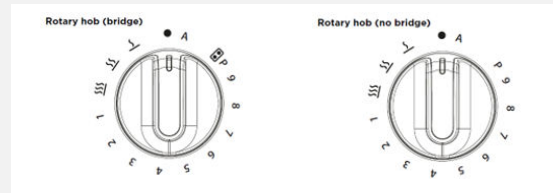

AUTO POWER TUNING

- Induction hobs have a unique power tuning system that automatically tunes the power to the size of the pan base - this ensures energy isn't wasted.



CAUTION

Never leave the hob unattended when in use.

- To turn an induction zone off, select the control knob for the relevant cooking zone.
- Turn the knob anti-clockwise to the off position.
- The hob digital display goes dark or shows **H** if the glass surface is still hot (above approximately 60°C).

SWITCHING AN INDUCTION ZONE ON AND OFF, AND SELECTING A POWER LEVEL

- Select the control knob for the relevant cooking zone.
- Turn the knob clockwise to the power level required.
- The power level is displayed on the hob digital display.
- Adjust the power level by turning the relevant control knob at any time.

USING THE AUTOMATIC BOIL AND SIMMER FUNCTION



CAUTION

Do not fill the pan more than about two-thirds full of water - allow space for the volume to increase when heated.



NOTE

- Level 9, power boost and the keep warm functions are not available to select as the on-going simmer rate.
- The on-going simmer rate must be between 1 and 8.

- The automatic boil and simmer function allows a pan to come to the boil and then turn down to an ongoing simmer rate without you having to adjust the control knob again.
- This function can be used on all of the five cooking zones.
- Select the control knob for the relevant cooking zone.
- Turn the knob anti-clockwise, to the left, as far as it will go, to the 'A' position, and hold it in that position for about 2 seconds.
- Then, within the next 10 seconds, turn the knob back to the on-going simmer rate power level, such as level 1 or 2.
- The digital display shows **A** (automatic heat-up) alternating with the number for the on-going simmer rate.
- The electronics will bring the cooking zone up to power level 9 for several minutes while the pan comes to the boil, and then will automatically reduce the power level to the on-going simmer rate.
- If you ever needed to cancel the automatic boil and simmer function, simply turn the control knob anti-clockwise to the off position, and then turn the control knob back clockwise to the power level you require.

USING THE KEEP WARM FUNCTIONS

USING THE MELTING CHOCOLATE FUNCTION (KEEP WARM FUNCTION 1)



NOTE

The melting function can be used for 2 hours continuously.

- The melting chocolate function heats the base of the pan to approx. 45°C (approx. 42°C in the pan).
- This is useful for melting chocolate directly in the pan (without the need to use a bain marie), and is useful for the gentle heating of sauces.
- Select the control knob for the relevant cooking zone and turn it clockwise to the **L** symbol. **L** appears in the display.

USING THE WARMING FUNCTION (KEEP WARM FUNCTION 2)



NOTE

The warming function can be used for 2 hours continuously.

- The warming function heats the base of the pan to approx. 70°C (approx. 65°C in the pan).
- This is useful for keeping foods warm prior to serving and for gentle simmering.
- Select the control knob for the relevant cooking zone and turn it



clockwise to the  symbol.  appears in the display.

USING THE RAPID SIMMER FUNCTION (KEEP WARM FUNCTION 3)



NOTE

The rapid simmer function can be used for 2 hours continuously.

- The rapid simmer function heats the pan to approx. 94°C.
- This is useful for rapid simmering at a lower level than power level 1.
- Select the  control knob for the relevant cooking zone and turn it clockwise to the symbol.  appears in the display.

USING THE POWER BOOST FUNCTION





NOTE

- The power boost function will operate for approx. 10 minutes before returning to power level 9, but can be cancelled at any time by turning the control knob to a different power level.
 - Please note that pans will generally heat up quickly on induction hobs, especially when using the power boost function.
 - Please ensure that pans are not over-filled with water to prevent them boiling over.
 - If you were to boost two zones on the same side of the hob, the zone most recently boosted would stay on power level P, while the other zone would be reduced to power level 9.
-
- The power boost function temporarily boosts the power to a cooking zone, so that water can come to the boil more quickly, by 'borrowing' power from an adjacent cooking zone.
 - The power boost can be used on any of the five cooking zones, but not all at the same time.
 - Select the control knob for the relevant cooking zone.
 - Turn the control knob clockwise, to the right, as far as it will go, to the 'P' position, and hold it in that

position for about 2 seconds until  appears in the digital display.

- Then release the control knob; it will settle on the power level 9 position.







USING THE BRIDGING FUNCTION

- The bridging function allows the two left-hand-side zones to operate as one larger zone when required, to accommodate larger pans, griddle pans and oval fish kettles, etc.
- Please note that the pans used must still have a magnetic base.
- When using the bridging function, the front-left zone acts as the primary zone, and the back-left zone acts as the secondary zone, so the power setting for both zones will be controlled by the front-left zone control knob.
- Rotate both the front-left zone and back-left zone control knobs together, clockwise to the right, as far as they will go, to the bridge position  and hold them for approximately two seconds to activate the bridging function.
- Release the back-left zone knob, and it will settle on the power level 9 position.
- Rotate the front-left zone knob back anti-clockwise to the required power level.
- The two zones will now operate as one larger zone, with the power level controlled by the front-left zone knob.
- The display for the back-left zone will show the bridging symbol  and the display for the front-left zone will show the selected power level.
- When you have finished using the bridging function, please turn both the front-left zone and

the back-left zone knobs anti-clockwise back to the off position.

- The two left-hand zones can then be operated as two separate zones once again.

ACTIVATING AND DEACTIVATING THE CHILD LOCK



- This feature is to help prevent accidental switching on of the hob, especially by young children.
- The child lock can be activated while the hob is in standby mode, with none of the zones in use.
- The child lock cannot be activated while the cooking zones are in use.
- To activate the child lock, rotate both the front-right zone and back-right zone control knobs together, anti-clockwise to the left, as far as they will go, to the 'A' setting, and hold them in position for about 5 seconds.
- Wait for the second beep, and until the 'L' symbols  and the key symbol  appear in the display, before releasing the control knobs.
- While the child-lock is active, if one of the hob zone control knobs are turned, the 'L' symbols  and the key symbol  will appear briefly in the display.
- To deactivate the child lock, rotate both the front-right zone and back-right zone control knobs together, anti-clockwise to the left, as far as they will go, to the 'A' setting, and hold them in position for about 5 seconds.
- Wait for the second beep, and until the 'L' symbols  and the key symbol  disappear from the display, before releasing the control knobs.

ADDITIONAL INFORMATION ABOUT THE ROTARY INDUCTION HOB

AUTO POWER TUNING

Induction hobs have a unique power tuning system that automatically tunes the power to the size of the pan base - this ensures energy isn't wasted.

IDLE MODE

- In idle mode all displays are dark, except if there is residual heat  present.
- Rotate one of the hob control knobs to leave idle mode.
- The display goes dark after about 15 seconds when the hob control knobs are all rotated to the off position, unless there is residual heat  present.

PAN DETECTION SYSTEM



NOTE

- If the  symbol does not disappear when a pan is placed on the zone, it indicates that the pan is not suitable for induction cooking.
- After a time of being switched on without a pan in position, the cooking zone turns off. To reactivate the cooking zone, turn the control knob back to the off position, and then back on to the required power level.

- When a zone has been switched on but no pan has been placed on the cooking zone, the zone will recognise that there is no pan in position and shows the symbol .
- It also means the hob only uses power when a suitable pan is placed on the zone.
- This reduces energy used during the cooking process, i.e. when you take your pan off the zone the hob automatically pauses, and only switches back on when you replace the pan.

RESIDUAL HEAT INDICATORS



NOTE

The cook zone itself does not heat up, but the ceramic glass does get hot because of the hot pan conducting heat back onto the hob glass.

- If the cook zone is switched off and the glass surface temperature is above approximately 60°C, 'H'  will be displayed in the cook zone display until the glass surface temperature drops below approximately 55°C.
- This feature not only warns you against hot surfaces but also indicates that there is residual heat which can be used as a temporary warming zone.

AUTO STAND BY

- A cooking zone that has exceeded the maximum operating time switches off automatically.
- To reactivate the cooking zone, turn the control knob back to the off position, and then back on to the required power level.

POWER MANAGEMENT SYSTEM

- The power management system manages the power to all the cooking zones.
- The latest set cooking zone is prioritised.
- If there is no power, the set power level of a cooking zone will not be displayed.
- The display changes when rotating the control knob to the actual power level.

OVERHEATING PROTECTION SYSTEM

- If a cooking zone gets too hot, for example because an empty pan had been heated for too long, or a pan had boiled dry, the power level of the cooking zone will be automatically reduced by the electronics.
- In this case, rotate the control knob of the relevant cooking zone to the power level indicated on the display before increasing the power level later.

Overheating Protection



Approximate Glass Surface Temperature (°C)	Action taken by the electronic overheating protection system
200°C	Reduces power boost setting to power level 9.
250°C	Reduces current power level by 40%.
270°C	Switches the affected cooking zone off.
300°C	Switches the whole induction hob off.



CAUTION
Never leave the hob
unattended when in use.

INDUCTION DISPLAY SYMBOLS (Rotary Models)

INDUCTION DISPLAY SYMBOLS (Rotary models)		
Feature	Symbol	Description
Digital Display		Shows the current power level or active feature per cook zone.
Child Lock		The child lock has been activated.
Automatic heat-up		Automatic boil and simmer function has been activated. The 'A' alternates with the power level of the on-going simmer rate.
Melting Chocolate Function		The melting chocolate function has been activated.
Warming Function		The keep warm / gentle simmer function has been activated.
Rapid Simmer Function		The rapid simmer function has been activated.
Power Boost		Temporarily boosts the power to a cooking zone. The power boost function has been activated.
Overwind symbol (lightning flash) flashing		The control knob has been turned as far as possible clockwise or anti-clockwise, and has been held in the 'P' or 'A' position for longer than approximately 30 seconds. Release the control knob and the overwind symbol will disappear within a few seconds.
Bridging Function		Creates a bridged cooking zone of the two separate left-hand cooking zones. The bridging function has been activated.

INDUCTION DISPLAY SYMBOLS (Rotary models)		
Feature	Symbol	Description
Pan Detection (no pan or unsuitable pan)		Lets you know if the correct pans are being used and helps to save energy. When a pan is lifted off the zone, the power is automatically cut. There is no pan on the zone, or the pan is not suitable (it does not have a flat magnetic base or its diameter is not large enough).
Residual Heat Indicator		Warns you against hot surfaces but also indicates that there is residual heat which can be used as a temporary warming zone. The surface of the hotplate glass is still hot after cooking. The 'H' will show while the glass surface temperature is above approx. 60°C, and will go out when the glass surface temperature falls below approx. 55°C.
Over-heat indicator	E2	Indicates that a cooking zone may have overheated, possibly because an empty pan has been heated for too long, or because a pan has boiled dry. Remove the pan and switch the hob off. Allow the cool down for 30 minutes before trying to use the hob again.
Obstruction indicator	ER03	Accompanied by a tone sounding - indicates that there is something covering the display area, such as a pan or a tea towel, or simply water, grease or fingerprints. Remove any objects and clean the area before trying to use the hob again.

For other messages or error codes, please switch the cooker off at the wall for a few minutes to let the electronics reset. If the error message persists after the power has been restored, please contact the customer services department using the contact details on the back cover.

OVENS & GRILLS

OVENS

When using the top oven or second fanned oven, the white thermostat indicator light will come on until the selected temperature is reached.

When the top oven or grill is switched on, the cooling fan(s) come on to keep the fascia and control knobs cool during cooking/grilling. The cooling fans may operate when the main ovens are in use depending on the temperature setting and length of cooking time. The fan(s) may continue to operate for a period after the oven/grill has been switched off. During use the fan(s) may cycle on and off, this is normal.



NOTE

The cooling fan may run for around 1 hour after use. This is normal to ensure the exterior parts of the cooker fully cool down and because the oven cavity is very well-insulated to prevent heat escaping during the cooking process. Please do not switch the cooker off at the wall before the cooling fan has stopped completely.



IMPORTANT

Never put items directly on top of the base of the oven, or cover the oven base with foil, as this may cause damage. Always position items on the shelf.



NOTE

The main oven will not operate manually if the programmer is set to automatic cooking, or is locked. See the Clock/Programmer section for more information.

USING THE GRILL

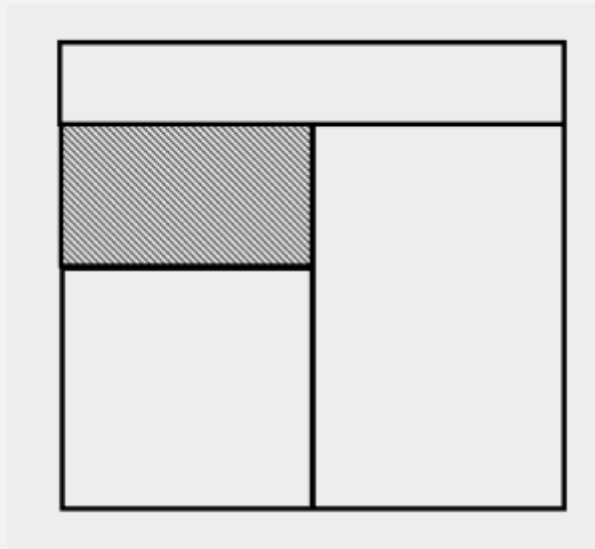

WARNING

Never cover the grill pan or grill trivet with aluminium foil, or allow fat to build up in the grill pan, as this creates a fire hazard.



TIP

For best grilling results use shelf position 2 and a 6 minute pre-heat.

THE COOLING FAN

During use the fan may cycle on and off, this is normal.

When the grill is switched on, the cooking fan comes on to keep the fascia and control knobs cool during grilling. The fan may continue to operate for a period after the grill has been switched off.



NOTE

The cooling fan may run for around 1 hour after use. This is normal to ensure the exterior parts of the cooker fully cool down and because the oven cavity is very well-insulated to prevent heat escaping during the cooking process. Please do not switch the cooker off at the wall before the cooling fan has stopped completely.

USING THE GRILL



CAUTION

Accessible parts may be hot when the grill is used - young children should be kept away.

**IMPORTANT**

The grill door must be fully open when the grill is used.

**TIP**

For grilling small quantities of food, the centre (economy) grill can be used with the grill trivet inverted. For large quantities of food, the full grill can be used.

**WARNING**

The grill-pan handle is designed for sliding the grill-pan in and out. Do not attempt to carry the grill pan by the handle.

**WARNING**

The top oven/grill door must be open when the grill is used for conventional grilling.

1. Open the grill door. Turn the control knob to the required setting. For best cooking results, we recommend that you preheat the dual grill for 3 minutes and the single grill for 5 minutes.
2. Push the grill pan towards the back of the shelf to position it under the grill.
3. To switch off return the control knob to the off position.

GRILL PAN AND TRIVET

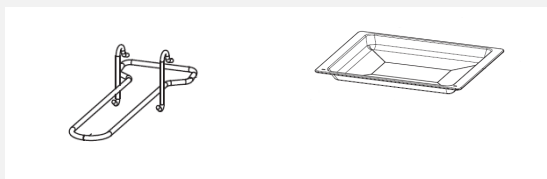

The trivet sits inside the grill-pan.

The holes and the sloping lip of the grill-pan go at the back.

The grill-pan handle clips over the front of the grill-pan. Ensure that the grill-pan handle prongs are at the top, and the wider support piece sits underneath the grill-pan.

USING THE TOP OVEN

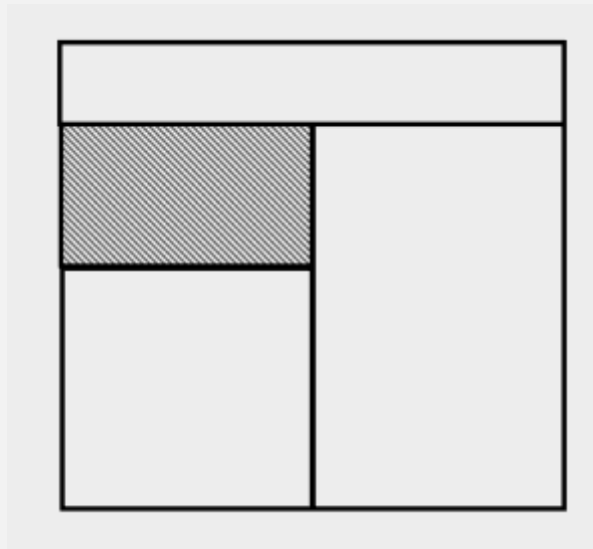

WARNING

When you are cooking keep children away from the vicinity of the oven.



CAUTION

The top element gets extremely hot when in use, so take extra care to avoid touching it.



NOTE

The top oven is a conventional oven and is not controlled by the programmer.

TO TURN ON THE TOP OVEN

1. Turn the temperature control knob until the required temperature is selected. The white thermostat indicator will come on until the selected temperature is reached, and then go off. It will turn on and off periodically as the thermostat operates to maintain the selected temperature.

2. To switch off, return the top oven control knob to the off position.

Important: Never put items directly on the base of the oven, or cover the oven base with foil, as this may cause the element to overheat. Always position items on the shelf.

COOLING FAN

During use the fan may cycle on and off, this is normal.

When the top oven is switched on, the cooking fan comes on to keep the fascia and control knobs cool during grilling. The fan may continue to operate for a period after the top oven has been switched off.

PREHEATING

Preheat the oven until the indicator light switches off for the first time, this will take up to 15 minutes depending on the temperature selected.

The oven must be preheated when cooking frozen or chilled foods, and we recommend preheating for yeast mixtures, batters, soufflés, and whisked sponges.

Put the oven shelves in the position required before preheating the oven.

Position baking trays and roasting tins on the middle of the shelves, and leave one clear shelf position between shelves, to allow for circulation of heat.

WHEN USING THE TOP OVEN

As part of the cooking process, hot air is expelled through a vent at the top of the oven. When opening the oven door, care should be taken to avoid any possible contact with potentially hot air, since this may cause discomfort to people with sensitive skin. We recommend that you hold the underneath of the oven door handle.

USING THE MAIN OVEN

The Main Multi-Function Oven

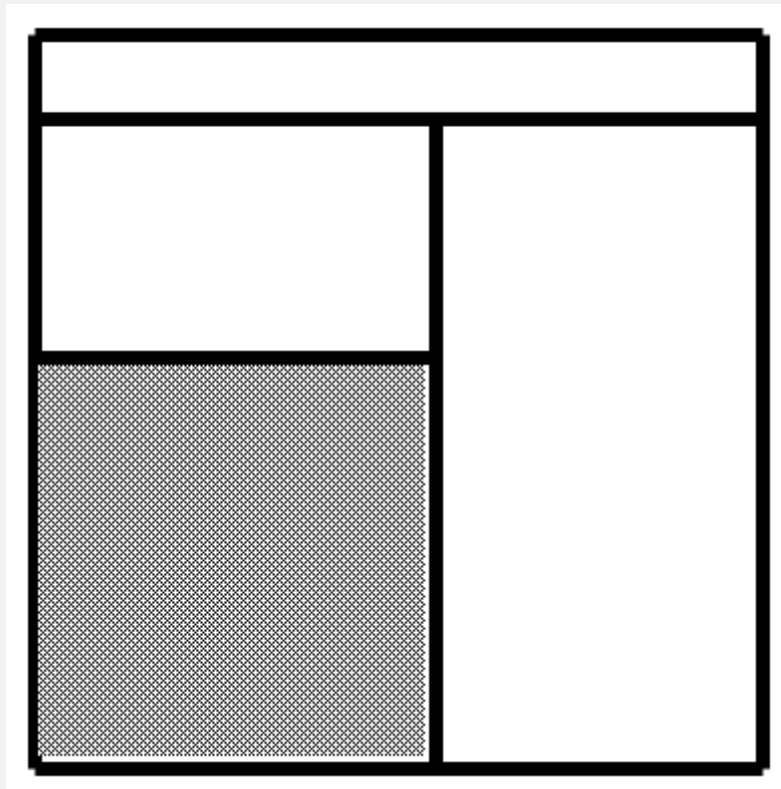

WARNING

Accessible parts may be hot when the oven is used. Young children should be kept away.

SELECTING A COOKING FUNCTION

To start a cooking operation, a cooking function and a heating temperature must be selected.

Setting a cooking function

- Rotate the function control to select the desired cooking function.

To modify or cancel the cooking function:

- Rotate the function control to select another cooking function.
- Rotate the function control to off to cancel the cooking function.

Setting a heating temperature:

- Turn the temperature control dial to select the desired heating temperature. The selected temperature shows in the display.

To modify or cancel the heating temperature:

- Rotate the temperature control to select another heating temperature.
- Rotate the function control dial to off to switch the oven off.

PREHEATING

The oven starts preheating when a cooking function and heating temperature have been set.

The temperature symbol $^{\circ}\text{C}$ blinks to indicate preheating.

The temperature symbol permanently lights up and an acoustic signal sounds to indicate the oven has reached the set temperature.

Fast preheat function

The fast preheat function automatically activates after selecting a cooking function that supports it.

The fast preheat function reduces the time the oven needs to reach the selected heating temperature.

The display shows the fast preheat symbol. P

The fast preheat function automatically deactivates after the selected heating temperature is reached.



NOTE

- Please note there are two sets of beeps relating to the pre-heating of the digital main oven.
- When a main cooking function is selected (true fan, pizza, fan assisted, or conventional top and bottom heat), the rapid pre-heat function engages automatically to help get the cavity up to temperature more quickly.
- The rapid pre-heat indicator (P) appears and the pre-heating indicator ($^{\circ}\text{C}$) flashes.
- After a few minutes, three short beeps will sound and the rapid pre-heating indicator (P) goes out.
- This indicates that the rapid pre-heat phase has ended and the oven is switching to the main ongoing cooking function mode which was selected.
- The pre-heating indicator ($^{\circ}\text{C}$) continues to flash until the required temperature has been reached.
- After a further few moments, a further three short beeps will sound.
- This indicates that the required temperature has been reached and the pre-heating indicator ($^{\circ}\text{C}$) stops flashing and shows steadily.

- At this point, the food should be placed in the oven.

COOKING WITH A FANNED OVEN



CAUTION

As this is a high efficiency oven, you may notice the emission of steam from the oven when the door is opened. Please take care when opening the door.

If you are used to cooking with a conventional oven you will find a number of differences to cooking with a fan oven which will require a different approach.



TIP

Foods are cooked at a lower temperature than a conventional oven, so conventional recipe temperatures may have to be reduced.



TIP

Preheating is generally not necessary as a fan oven heats up quickly.



TIP

There is no flavour cross-transference in a fan oven, which means you can cook strong smelling foods such as fish at the same time as mild foods - e.g. milk puddings.



TIP

When batch baking foods that will rise during cooking- e.g. bread, always ensure that enough space has been left between the shelves to allow for the rise.

- There are no zones of heat in a fan oven as the convection fan at the back of the oven ensures an even temperature throughout the oven. This makes it ideal for batch baking - e.g. when planning a party as all the items will be cooked within the same length of time.



NOTE

When 2 or more shelves are being used, it may be necessary to increase the cooking time slightly.



NOTE

Because the 2 oven shelves are wider than in many ovens, it is often possible to cook 2 items per shelf.



NOTE

When roasting meats, you will notice that fat splashing is reduced, which is due in part to the lower oven temperatures, and will help keep cleaning of the oven to a minimum.

**NOTE**

There is no need to swap dishes onto different shelves part way through cooking, as with a conventional oven.

DEFROSTING AND COOLING IN THE MAIN OVEN

To defrost frozen foods, turn the oven control to the defrost position, place the food in the centre of the oven and close the door.

To cool foods after cooking prior to refrigerating or freezing, turn the main oven control to the defrost position and open the door.

**CAUTION
BE SAFE:**

Ensure that the food is fully defrosted before cooking or consuming.

USING THE AIRFRY FUNCTION

Simply choose the AirFry setting on the main oven control, then place your chips, vegetables or chicken on the specially designed air fryer tray.

The tray allows more air to circulate speeding up cooking time, reducing the need for any extra oils, making cooking healthier.

AirFry is great for cooking chips, meat and to prepare meals that you would normally grill.

There's a few things which don't AirFry well including cakes, pastries and breads as they can become dry or tough. Foods in a wet batter also can not be cooked by AirFrying.

1. Select the AirFry function on the main oven and set the temperature to 220°C.
2. Position the metal Airfry tray on the 3rd (centre) shelf position from the bottom. Food should be evenly spaced on the airfry tray in a single layer to allow for even cooking.
3. Place a baking tray, or the grill pan, on the shelf position below the AirFry tray to catch any crumbs or drips.

**WARNING**

For recipes with 30 minutes or longer cooking time a 5-10 minute pre-heat time is recommended.

Frozen or dense foods may require additional cooking time.

**NOTE**

If you're using a non-air fryer recipe, make sure you shorten the cooking time as food will cook faster than a conventional oven.



IMPORTANT

- Air Frying in a large oven cavity allows for more food to be air-fried simultaneously, so longer cooking times are to be expected compared to a worktop air fryer.
- Please adjust cooking times accordingly.
- For best results, when consulting recipes and cooking instructions on food packaging, please look for the conventional oven timings, not the worktop air fryer timings or regular fanned oven timings.
- Reduce the conventional oven timings by around 30%.
- Ensure that the food is thoroughly cooked prior to serving.



NOTE

It may be necessary to lightly spray the airfry tray with oil to avoid food sticking to it.









IMPORTANT



Greasy foods may cause smoke during the airfry cycle, maintaining a clean oven and using a baking tray below to catch debris is recommended.

MAIN OVEN COOKING FUNCTIONS EXPLAINED

Symbol and Function Name	Temperature Range	Notes	Usage
 True Fan Oven	30°C to 260°C Default temperature is 180°C The temperature can be adjusted in 5°C increments	Incorporates rapid pre-heat function. Use any suitable shelf position. Can batch bake on more than one level at the same time, but please leave enough space for the food to rise.	Operates the fan heating element and circulation fan on the back wall of the oven. Gives an even temperature distribution throughout the oven cavity for batch baking, so you can cook on more than one shelf level at the same time. Blows hot air directly into the oven cavity so generally requires little to no pre-heating, and can cook at lower temperatures for shorter durations, therefore generally being the most efficient cooking mode.

Symbol and Function Name	Temperature Range	Notes	Usage
			<p>Circulating air avoids cross-transference of flavours and smells from one dish to another.</p> <p>Cook on any suitable shelf position.</p> <p>With most recipes, reduce cooking temperature by about 20°C compared to conventional ovens, and reduce the cooking time a little.</p>
 <p>Conventional Oven</p>	<p>30°C to 260°C</p> <p>Default temperature is 200°C</p> <p>The temperature can be adjusted in 5°C increments</p>	<p>Incorporates rapid pre-heat function.</p> <p>For best results, cook on one shelf and use the middle shelf position.</p>	<p>Operates the upper and lower heating elements to provide a conventional cooking mode.</p> <p>Please remember, the oven temperature selected relates to the centre of the oven; the oven cavity will be a bit hotter at the top and a bit cooler at the bottom.</p> <p>However the different zones of heat can be useful if roasting, with meat placed towards the middle of the oven and roast potatoes at the top.</p> <p>Requires pre-heating for best results.</p> <p>Useful for traditional baking and roasting.</p> <p>For best results, please place the food on the middle shelf position and cook on one shelf level only.</p>
 <p>Pizza (true fan mode with base heat)</p>	<p>50°C to 260°C</p> <p>Default temperature is 180°C</p> <p>The temperature can be adjusted in 5°C increments</p>	<p>Incorporates rapid pre-heat function.</p> <p>For best results, cook on one shelf and use the middle shelf position.</p>	<p>The fan heating element and circulation fan come on to cook the pizza, including the topping.</p> <p>The base heating element comes on to crisp the base of the pizza.</p> <p>Requires pre-heating for best results.</p> <p>For best results, please place the food on a middle shelf position.</p>
 <p>Air-fryer</p>	<p>150°C to 230°C</p> <p>Default temperature is 230°C</p> <p>The temperature can be adjusted in 5°C increments</p>	<p>Does not incorporate the rapid pre-heat function (because this function already uses the circulation fan, fan element and upper element).</p> <p>Place the air fry tray in the middle</p>	<p>Operates the fan element and circulation fan to cook the food, and the upper element to crisp the food.</p> <p>Good for frozen chips, chicken pieces, chicken nuggets, fish fingers, etc.</p> <p>Place the air fry tray into the middle shelf position of the main oven.</p>

Symbol and Function Name	Temperature Range	Notes	Usage
		shelf position, with the grill pan below it.	<p>Place the grill pan below the air fry tray to catch any drips or food particles.</p> <p>Do not use the air fryer function for general cooking, roasting and baking, as the food may over-cook as there would be additional heat generated by the upper element.</p> <p>Because of the larger cooking capacity, cooking times would need to be increased compared to a worktop air-fryer.</p>
 <p>Defrost and dough-proving</p>	Not applicable – please leave the temperature selector in the off position.	Use the middle shelf position.	<p>The circulation fan runs without any heat.</p> <p>With the oven door closed, room temperature air is circulated around the food. This helps frozen items such as bread and gateaux to defrost in about half the usual time.</p> <p>With the oven door closed, room temperature air is circulated around the dough. This provides a suitable environment for the dough to rise prior to baking.</p> <p>With the oven door open, this function helps to cool cooked food prior to refrigeration.</p>
 <p>Intensive bake (fan-assisted oven)</p>	<p>30°C to 260°C</p> <p>Default temperature is 200°C</p> <p>The temperature can be adjusted in 5°C increments</p>	<p>Incorporates rapid pre-heat function.</p> <p>For best results, cook on one shelf and use the middle shelf position.</p>	<p>Operates the upper and lower heating elements and the circulation fan to circulate the heat.</p> <p>Helps to ensure a more even temperature distribution throughout the oven cavity.</p> <p>Good for baking items with a higher moisture content, such as quiche, bread and cheesecakes.</p> <p>Requires pre-heating for best results.</p> <p>Useful for pizzas, pies, quiches and recipes which require a crisp base and a browned top.</p> <p>For best results, please place the food on a middle shelf position.</p>
	<p>80°C to 230°C</p> <p>Default temperature is 180°C</p>	Does not include the rapid pre-heat function.	Operates the upper element only to brown dishes like shepherd's pie, lasagne, cauliflower cheese, etc.

Symbol and Function Name	Temperature Range	Notes	Usage
Top heat	The temperature can be adjusted in 5°C increments	For best results, cook on one shelf and use the middle shelf position.	Often used during the last few minutes of the cooking process. For best results, please place the food on a middle shelf position to avoid over-browning.
 Base heat with circulation fan	50°C to 220°C Default temperature is 200°C The temperature can be adjusted in 5°C increments	Does not include the rapid pre-heat function. For best results, cook on one shelf and use the middle shelf position.	The lower heating element comes on to crisp the base, and the circulation fan gently circulates heat around the food to avoid overcooking. Useful for open pies and tarts or baking pastry cases, etc. Requires pre-heating for best results. For best results, please place the food on a middle shelf position.
 Fan-assisted grill	3 power levels: 3 - high 2 - medium 1 - low	Pre-heat for 3-5 minutes before adding the food. Choose a suitable medium to high shelf position.	Operates the upper inner grill heating element and circulation fan. Useful for circulating heat around thicker meats, like sausages and chicken pieces without the need to turn the food as often. Gives a rotisserie spit-roast-effect flavour, without the need to have a rotisserie motor and roasting spit in the oven. Choose a suitable medium to high shelf position, but ensure that the food will not come into contact with the heating element. Use with the door closed.
 Conventional grill	3 power levels: 3 - high 2 - medium 1 - low	Pre-heat for 3-5 minutes before adding the food. Choose a suitable medium to high shelf position.	Operates the upper inner grill heating element. Pre-heat for a few minutes for best results. Useful for toasting and grilling thinner meats, like bacon. Choose a suitable medium to high shelf position, but ensure that the food will not come into contact with the heating element. Use with the door closed in the main oven. (For the grill in the top oven, use with the door open).

Symbol and Function Name	Temperature Range	Notes	Usage
 Light only	Not applicable	Oven lamp comes on without heating.	Puts the light on without the heating elements coming on. Illuminates the oven cavity which is useful when wiping round the oven cavity.

OVEN FURNITURE

see website address on the back cover.

- Extra shelves may be ordered from our spares website - please

Type of shelf	Type of model	Cavity	Part number
50cm Deluxe	Stoves Richmond Deluxe (DX) range cookers	All cavities except right-hand tall oven cavity on 90cm models.	094108601
40cm Deluxe	Stoves Richmond Deluxe (DX) range cookers - 90cm models only	Only for right-hand tall oven cavity on 90cm models.	094108603

Baking trays and roasting tins:

For best cooking results and even browning, the recommended size of baking trays and roasting tins that should be used are as follows;

- Baking tray 350 mm x 250 mm
This size of baking tray will hold up to 12 small cakes.
- Roasting tin 370 mm x 320 mm

Position baking trays and roasting tins on the middle of the shelves, and leave one clear shelf-position between shelves, to allow for circulation of heat.

USING THE TALL FANNED OVEN WITH PRO-FLEX™ SPLITTER

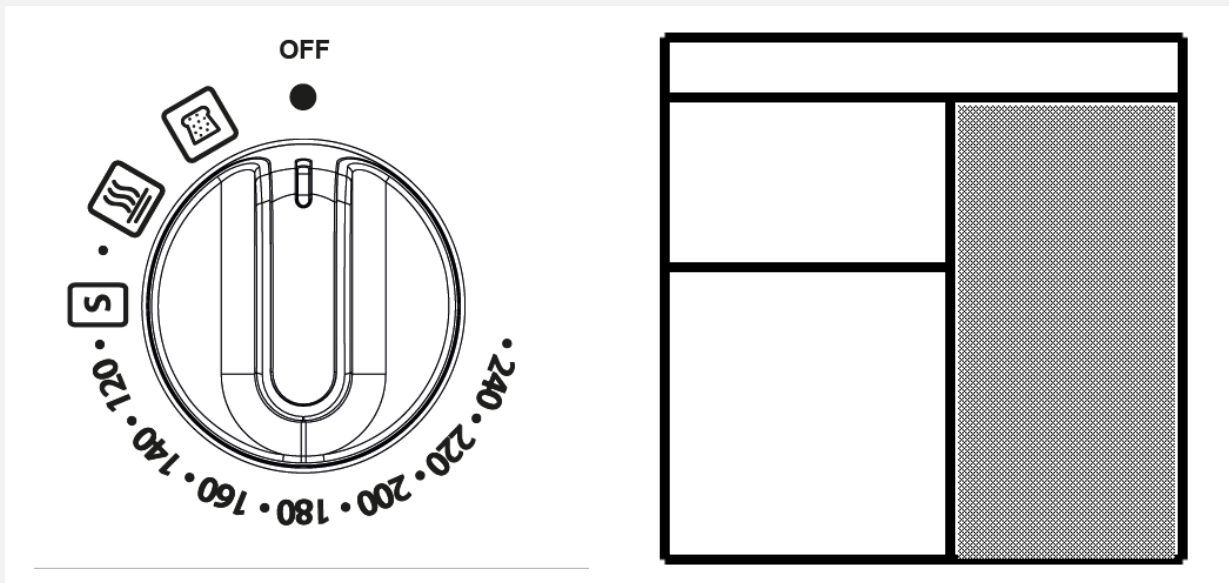

- With the PRO-FLEX™ splitter you can convert the tall oven into two separate fan ovens which can be controlled independently to maximise your cooking options.
- You can use the whole of the tall oven at one temperature, just

the top half of the oven to save energy, or the top and bottom halves of the oven as two separate ovens at different temperatures.



Turn the control knob to the temperature or function required.

Fanned Oven Additional Functions

Symbol	Description
	<p>Dough proving and defrost.</p> <p>Use with the door closed for dough-proving and defrosting.</p> <p>Use with the door open for cooling cooked food prior to refrigerating.</p>
	<p>Keep warm (70°C).</p> <p>For keeping cooked food warm prior to serving.</p>
	<p>Slow cook (100°C).</p> <p>For slow cooking of casseroles, etc.</p>

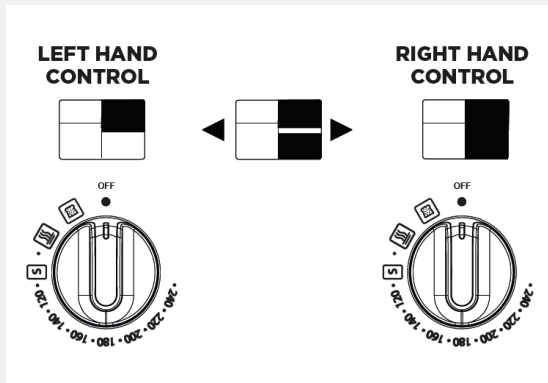

Function	Leave the splitter in the oven?	Which control knob to use?
Use whole of oven at one temperature - e.g. for batch baking.	No - remove the splitter.	The right-hand control knob only.
Using just the top-half of the oven to save energy.	Yes - insert the splitter.	The left-hand control knob only.
Using both halves of the oven to cook different foods at different temperatures.	Yes - insert the splitter.	The left-hand control knob for the top half and the right-hand control knob for the bottom half of the oven.

INSERTING AND REMOVING THE SPLITTER

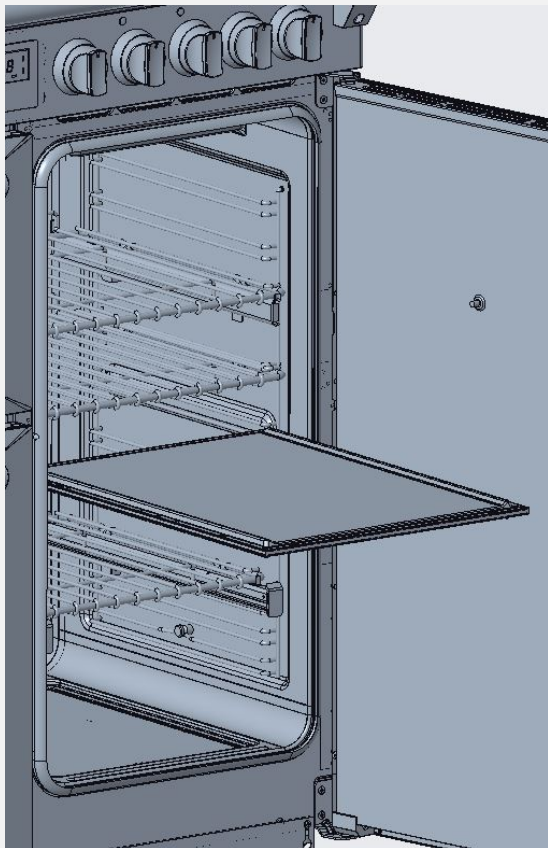

TO ACTIVATE THE TALL OVEN (WITHOUT SPLITTER)

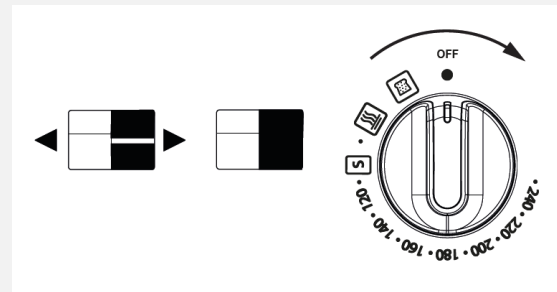

To use the tall oven without the splitter, turn the right hand control knob to the desired function or temperature.

TO ACTIVATE THE SPLITTER FUNCTION

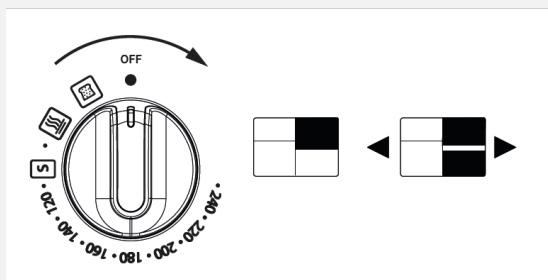

Upper Oven Only (with splitter)

To use the upper oven separately, firstly insert the splitter then turn the left hand control knob to select the function or the temperature. This will activate the top half of the oven.



IMPORTANT

Please do not use the splitter as a shelf and only position into the dedicated guides in the tall cavity.



NOTE

- We do not recommend using the top oven only for cooking frozen foods and foods with high moisture as this can result in excess condensation.
- When cooking foods with high moisture content, use either the full oven or both ovens.

UPPER AND LOWER OVENS (WITH SPLITTER)

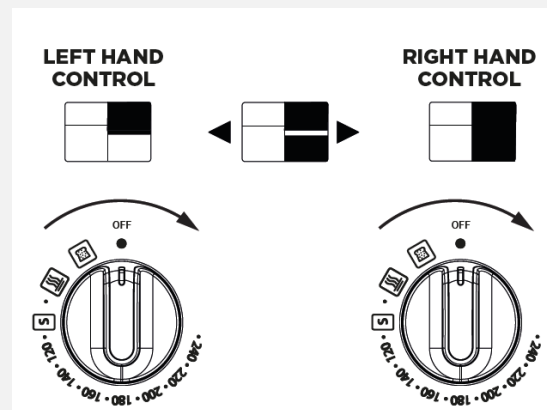

- With the upper oven activated by turning the right hand control knob to a function or temperature, the lower oven can also operate by turning the left hand control knob to the required function or temperature.
- The lower oven cannot be used separately by itself.



WARNING

- Please be aware that the splitter will get very hot during use.
- Only insert and remove the splitter when the oven is cool.

USING THE UPPER AND LOWER OVENS AT DIFFERENT TEMPERATURES

- When using the upper and lower ovens at different temperatures, use the upper oven at the higher temperature and the lower oven at the lower temperature.
- The table below shows the minimum temperature that can be achieved in the lower oven when the upper oven is in use.
- For example when the upper oven is 200°C, the minimum

temperature that can be used in the lower oven is 120°C.

Upper Oven temperature (°C)	Lower Oven Minimum temperature (°C)
100 (Slow Cook function)	70 (Keep Warm function)
120	80
140	90
160	100 (Slow Cook function)
180	110
200	120
220	130

USING OTHER ACCESSORIES

STEAM & INFUSE ACCESSORIES

The Steam & Infuse vertical cooking system is designed to deliver an evenly cooked, healthier, flavourful result every time. Simply fill the flavour pot with stock liquid, herbs or any other flavouring ingredients and place your poultry over the top.

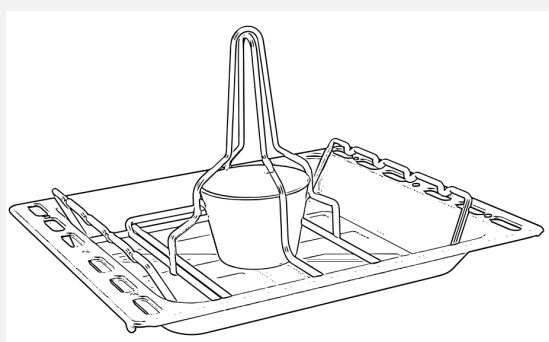

Supporting poultry vertically exposes all sides to the oven's heat, promoting more even cooking in a shorter time while allowing the fat to drip out for healthier cooking results. The heat turns the stock liquid to steam so that the flavour is infused into the meat from the inside.



NOTE

- The Steam & Infuse system is placed inside the deep grill pan.
- First remove the standard grilling trivet from the grill pan.
- Place the wide Steam & Infuse trivet into the grill pan, then place the flavour pot into the centre of the grill pan, and finally place the vertical trivet over the wide trivet.
- Place the grill pan in the main multi-function oven or the second fanned oven (on 100cm and 110cm-wide models) using the lowest shelf position.
- Do not attempt to use the Steam & Infuse system in the tall right-hand oven on 90cm-wide models.
- Always use the true fan cooking function  when using the Steam & Infuse system. This will ensure that the heat circulates around the poultry effectively for even cooking.
- The Steam & Infuse system is designed for cooking poultry up to 2.5kg in weight.
- When cooking with the Steam & Infuse system with true fan cooking mode, cooking times are usually reduced by

about 20% compared to conventional horizontal roasting. Be sure to check the poultry so that it does not over-cook. Please ensure that the poultry is thoroughly cooked through before serving. Insert a skewer or fork into the thickest part of the meat and make sure that the juices run clear before serving; if not, please return the poultry to the oven to cook for a little longer before testing again.



IMPORTANT

The skewers are not to be used in the tall right-hand oven on 90cm-wide range cookers and should always be orientated side to side across the oven, not front to back, so they do not come into contact with the oven circulation fan blades.

Also included are a set of skewers which are ideal for making kebabs and can be suspended over the specially designed rack.

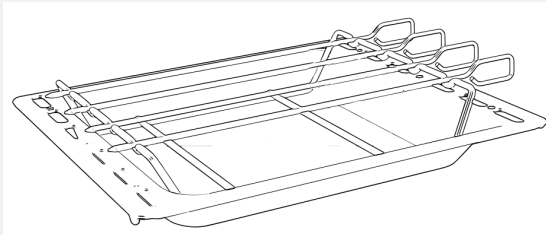

NOTE

The Steam & Infuse system is supplied with Stoves Deluxe (DX) range cookers. It may be purchased as an optional extra for Stoves Core range cookers - part number 094109600. Please visit the Spares section of our website - please see the website address on the back cover.

CLOCK/PROGRAMMER



NOTICE

If the clock/programmer is locked, it must be unlocked before the main multi-function oven can be used.

To lock/unlock the clock/programmer press and hold the middle clock key  for about 10 seconds, until a beep sounds.



NOTICE

The time of day must be set before the main multi-function oven can be used.

Please be aware that only the main multi-function oven is controlled by the programmable timer.













NOTE



Your clock/programmer may not have all of these functions.



NOTE

The timer is context-specific, so it will only show options when they are relevant. If the multi-function oven is not in use, then the timer only gives the minute minder option and the option to set the time of day. If the digital oven is in use, then the cooking duration and cooking end time options become available.

	Alarm - minute minder - the alarm sounds at the end of the set time as a reminder to check, stir, turn or baste the food, but does not switch the main oven off automatically.
	Cooking duration time - allows the main oven to switch off automatically.
	End of Cooking time - used in conjunction with the cooking duration time - allows the main oven to switch on and off automatically.
	Time of day - clock
	Pizza Function.
	AirFry Function.
	Light - oven lamp comes on without the heating to assist with cleaning.
	Oven Functions - different symbols light up depending on the cooking function chosen - please see the main oven functions table.
	Defrost / Dough Proving
	Temperature Unit (Celsius) - flashes when the main oven is pre-heating, and shows steadily when the main oven has reached temperature.
<i>h:min</i>	Units of time (hours: minutes)
	Rapid Pre-Heat function (activates automatically when using the true fanned oven, pizza, intensive bake/fan-assisted, or conventional oven functions).

	Automatic cooking symbol.
	Time Display.
	Child Lock.

USING THE TOUCH CONTROLS

- Left key: minus/decrease
- Middle key: menu key for scrolling through functions.
- Right key: plus/increase
 - When a function is selected and the time is set, the chosen function will automatically start a few seconds after the last key press.

MANUAL MODE



- If you do not set a cooking duration time or cooking end time on the clock/programmer, then the main oven can be switched on and off manually using the function control and temperature control knobs.
- To operate the main oven manually, the time of day must be set on the clock.

SETTING THE TIME OF DAY



NOTE

Ensure that the main oven function selector knob is in the off position before trying to set the time of day.

- When the cooker is first connected to the power supply, or following a power cut, the clock symbol  will be flashing on the display.
- The main oven will not work until the time of day has been set.
- While the clock symbol is flashing, use the plus and/or minus keys  to select the current time of day, using the 24 hour clock format.



TIP



If you hold down the plus or minus key the time will change more quickly.

- The time of day will be accepted a few seconds after the last key press and the clock symbol will stop flashing.



TIP

If you hold down the plus or minus key the time will change more quickly.

- To adjust the time of day, for example at the beginning and end of daylight saving time, touch the middle 'Clock' key  repeatedly until the clock symbol  starts to flash.
- While the clock symbol is flashing, use the plus and/or minus keys  to select the current time of day, using the 24 hour clock format.
- The time of day will be accepted a few seconds after the last key press and the clock symbol will stop flashing.



NOTE

The main oven functions will not work until the clock time of day has been set.



NOTE

A short time after the last touch of a timer key (after approximately 30 seconds), the timer display will dim a little. This is an energy-saving function. Pressing any timer key will brighten the timer display again.









SETTING TIMERS







NOTE

- The automatic cooking timers can only be used when a function and a temperature have been set on the main multi-function oven.
- Automatic cooking functions are only available on the main cooking functions: true fan, pizza, fan-assisted/intensive bake, air fryer, conventional top and bottom heat, top heat, base heat with fan, defrost and dough proving.
- The fanned grill, conventional grill, and light only functions cannot be controlled by the timer.
- The timer can only control the main multi-function oven.

MINUTE MINDER - the alarm sounds after the set time has elapsed, to remind you to check, turn, stir or baste the food, but the main oven does not switch off automatically.



- Touch the middle clock key  repeatedly until the bell symbol  starts to flash.
- While the bell symbol is flashing, use the plus and/or minus keys   to set the required minute minder duration time (up to a maximum of 23 hours and 59 minutes).
- After a few seconds, the minute minder duration time is accepted and starts to count down. If the main multi-function oven is in use, the minute minder counts down in the background. If the main multi-function oven is not in use, the minute minder counts down in the foreground.
- When the minute minder time has elapsed, the alarm sounds.
- Touch the middle clock key  to silence the alarm, otherwise the alarm will cancel itself after approximately 7 minutes.
- The display reverts to showing the current time of day.
- If you need to amend the minute minder duration time, touch the middle clock key  repeatedly again until the bell symbol  starts to flash.
- While the bell symbol is flashing, use the plus and/or minus keys   to adjust the required minute minder duration time (up to a maximum of 23 hours and 59 minutes).
- After a few seconds, the new minute minder duration time is accepted and starts to count down. If the main multi-function oven is in use, the minute minder counts down in the background. If the main multi-function oven

is not in use, the minute minder counts down in the foreground.

- When the minute minder time has elapsed, the alarm sounds.
- Touch the middle clock key  to silence the alarm, otherwise the alarm will cancel itself after approximately 7 minutes.
- The display reverts to showing the current time of day.
- If you need to cancel the minute minder function, touch the middle clock key  repeatedly again until the bell symbol  starts to flash.
- While the bell symbol is flashing, if required use the minus key  to adjust the minute minder duration time to '00:00'.
- After a few seconds, the minute minder function is cancelled.











NOTE





- The display screen is multi-functional, and is used to show the cooking function and temperature, as well as for setting the timer and minute minder.
- When the digital oven is not in use, the minute minder countdown will show in the display.
- When the digital oven is in use, the minute minder will countdown in the background, indicated by the bell symbol  in the display, while the display shows the cooking function and temperature.
- The alarm will sound as usual when the minute minder time has elapsed.
- While the digital oven is in use, please do not touch the middle clock key  to check on the remaining minute minder time, as this will reset the minute minder time to zero.

SETTING THE COOKING DURATION TIME - semi-automatic cooking - the main multi-function oven will switch off automatically after the set time.





- Firstly ensure that the current time of day has been set.
- Place the food in the main multi-function oven and select the required cooking function and temperature.
- Touch the middle clock key  repeatedly until the cooking

duration time symbol  starts to flash.









- While the cooking duration time symbol  is flashing, use the plus and/or minus keys  to set the required cooking duration time (up to 23 hours and 59 minutes).
- After a few seconds, the cooking duration time is accepted and starts to count down in the background.
- The automatic cooking symbol  lights up to show that the main oven is in automatic cooking mode, and the display reverts to showing the current time of day.
- When the cooking duration time has elapsed, the alarm sounds and the oven heating is switched off, but the oven lamp stays on to assist with removing the food. The automatic cooking symbol  flashes.
- Touch the middle clock key  to silence the alarm, otherwise the alarm cancels itself after approximately 7 minutes.
- Return the function selector control to the off position in order to return the multi-function main oven to manual mode.
- If you need to check or amend the cooking duration time, touch the middle clock key  repeatedly until the cooking duration time symbol  starts to flash and the current remaining cooking time is displayed. (After a few seconds, if no other keys are touched, the timer display reverts to showing the current time of day).
- If required, while the cooking duration time symbol  is flashing, use the plus and/or minus keys  to adjust the the required cooking duration time.

- After a few seconds, the new cooking duration time is accepted.
- If you need to cancel the cooking duration time, touch the middle clock key  repeatedly until the cooking duration time symbol  starts to flash, and the current remaining cooking time is displayed.
- While the cooking duration time symbol  is flashing, use the minus key  to adjust the cooking duration time to '00:00'.
- After a few seconds, the cooking duration time is cancelled. Please note the oven would then need to be switched off manually at the end of cooking.



SETTING THE COOKING END TIME
 - used in conjunction with the cooking duration time - fully-automatic cooking - the main multi-function oven will switch on and off automatically.

- Firstly ensure that the current time of day has been set.
- Place the food in the main multi-function oven and select the required cooking function and temperature.
- Ensure that the cooking duration time has been set as above.
- Touch the middle clock key  repeatedly until the cooking end time symbol  starts to flash.
- While the cooking end time symbol  is flashing, use the plus and/or minus keys  to set the required cooking end time (up to 23 hours and 59 minutes from the current time of day).
- After a few seconds, the cooking end time is accepted.
- The timer calculates the required start time automatically; for

example, if the required end time is 19:00 and the cooking duration time is 2 hours, then the start time will be calculated as 17:00.

- The automatic cooking symbol  lights up to show that the main oven is in automatic cooking mode, and the display reverts to showing the current time of day.
- When the calculated start time arrives, the heating and oven lamp are switched on in the main multi-function oven.
- When the cooking duration time has elapsed, the alarm sounds and the oven heating is switched off, but the oven lamp stays on to assist with removing the food. The automatic cooking symbol  flashes.
- Touch the middle clock key  to silence the alarm, otherwise the alarm cancels itself after approximately 7 minutes.
- Return the function selector control to the off position in order to return the multi-function main oven to manual mode.
- If you need to check or amend the cooking end time, touch the middle clock key  repeatedly until the cooking end time symbol  starts to flash and the current cooking end time is displayed. (After a few seconds, if no other keys are touched, the timer display reverts to showing the current time of day).
- If required, while the cooking end time symbol  is flashing, use the plus and/or minus keys  to adjust the the required cooking end time.
- After a few seconds, the new cooking end time is accepted.
- If you need to cancel the cooking end time, touch the middle clock key  repeatedly until the

cooking end time symbol  starts to flash, and the current cooking end time is displayed.





- While the cooking end time symbol  is flashing, use the minus key  to adjust the cooking end time to the current time of day.
- After a few seconds, the cooking end time is cancelled.
- Please note, if both a cooking duration time and a cooking end time have been set, then they must both be cancelled. Please note the oven would then need to be switched off manually at the end of cooking.



TIP

- If you ever need to quickly cancel semi-automatic cooking or fully-automatic cooking, or have made a mistake when entering cooking times, the easiest thing to do is to turn the main oven function selector knob back to the off position.
 - This will turn the oven off and cancel all of the timer settings.
 - You can then switch the main oven back on and re-enter the timer settings as required.
- For all the above settings, the times entered will be automatically accepted a few seconds after the last key press.

ACTIVATING AND DEACTIVATING THE TIMER CHILD LOCK

- The child lock can be used to prevent the main multi-function oven being switched on, or to prevent the settings being changed.
- To activate the child lock, touch and hold the middle clock key  for about 10 seconds, until a short beep sounds and the lock symbol  appears in the display.
- While the child lock is active, the lock symbol  shows steadily in the display.
- While the child lock is active, if the timer keys are touched, or the function selector control knob is turned, a beep sounds and 'LOC' appears briefly on the display.
- To deactivate the child lock, touch and hold the middle clock key  for about 10 seconds, until a short beep sounds and the lock symbol  disappears from the display.



ACTIVATING AND DEACTIVATING THE TIMER DEMONSTRATION MODE (FOR SHOWROOMS ONLY)



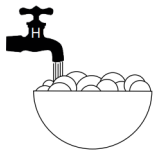

- **Demonstration mode allows the digital timer functions to be demonstrated without the main multi-function oven heating up.**
- **The function selector control knob can then be used to scroll through the cooking functions, and the temperature selector can be turned to show how to adjust the temperature without the heating elements coming on.**
- **The light will come on inside the main multi-function oven, but it will not heat up.**
- **To activate the demonstration mode, firstly switch the appliance on at the wall and set the time of day on the timer.**
- **Do not turn the function selector or temperature selector control knobs - leave the main multi-function oven off in standby mode.**
- **Touch and hold the plus and minus keys  simultaneously for about 10 seconds until 'dEm' and 'on' appear on the display.**
- **The timer is now in demonstration mode.**
- **To deactivate the demonstration mode, do not turn the function selector or temperature selector control knobs - leave the main multi-function oven off in standby mode.**
- **Touch and hold the plus and minus keys simultaneously for about 10 seconds until 'dEm' and 'off' appear on the display.**
- **The timer has now been taken out of demonstration mode and is in normal operational mode.**

CLEANING YOUR APPLIANCE

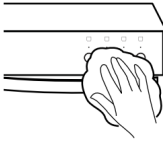
Cleaning: Do's

	<p>Use warm, soapy water</p>
	<p>Wipe the appliance with a damp cloth</p> <ul style="list-style-type: none"> • Clean the cloth regularly
	<p>Dry with a soft dry cloth</p>

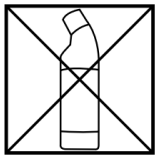
Cleaning: Don'ts

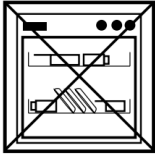
	<p>Don't use undiluted bleaches or Chloride products</p>
	<p>Don't use Wire Wool, Abrasive cleaners, Nylon pads or Steam Cleaners</p>
	<p>Do not wash the cast iron griddle, wok cradle, pan supports or telescopic sliders in the dishwasher</p>



NOTE

Always switch off your appliance and allow it to cool down before you clean any part of it.



NOTE

Please take extra care when cleaning over the symbols on the control panel, as this can lead to them fading.



NOTE

Tips: Some foods can mark or damage the metal or paint work e.g; Vinegar, fruit juices and salt. Always clean food spillages as soon as possible.



CAUTION

It is important to clean your appliance regularly as a build up of fat can affect its performance or damage it and may invalidate your guarantee.



CAUTION

In addition to the above, do not use metal scrapers to clean the oven door glass, ceramic hob surface or any glass lids.

STEAM ASSISTED CLEANING

This function uses hot steam to help gently soften grease & residue in your oven. Remove the shelves, grill-pan, air-fry tray and shelf supports from the oven first. Simply pour 200ml of cold water into the built-in well at the bottom of the oven cavity.

Select the conventional oven (top and bottom heat) function at 90°C and let the steam to get to work for 30-60 minutes.

After 30-60 minutes, switch the oven off and let it cool for a few minutes. Use a damp micro-fibre cloth to wipe away the grease, residues and splatters.

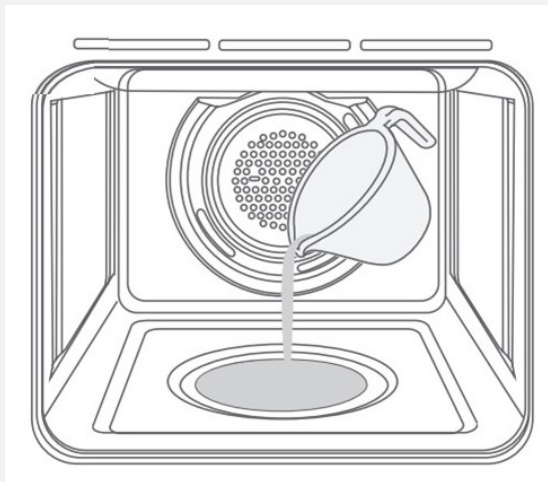

CAUTION

- Do not use the steam-assisted cleaning method with any cooking function that uses the circulation fan (such as fan oven mode) as moisture could be drawn into electrical components, possibly leading to operational issues.
- Do not use steam cleaners to clean the appliance.
- Steam-assisted cleaning must only be used with the conventional top and bottom heat function () in conventional ovens and multi-functional ovens.



CAUTION

- Ensure the oven has cooled sufficiently before wiping it with a damp cloth.
- Be careful not to touch the upper heating element which may still be hot, and be aware that the floor of the oven cavity may still be hot.

CLEANING AND CARE GUIDANCE

Area of appliance / material	Cleaning guidance	Example products
Ceramic glass hot-plates	<ul style="list-style-type: none"> • Clean with a ceramic hotplate cleaner/conditioner, applied with kitchen paper, following the instructions on the package. • Rinse with a damp, well-wrung out soft cloth. • Polish dry with a microfibre cloth. • If you do ever use a hob scraper to remove stubborn marks or deposits, please apply some ceramic hob cleaner onto the ceramic glass surface first, so that the hob scraper blade can glide across, at a 45° angle, without scratching the surface. • Please note that the cooker manufacturer cannot accept responsibility for scratches or damage to the ceramic glass surface caused by the use of a hob scraper. • Kitchen foil and spillages of sugary foods must not be allowed to bake onto the ceramic glass surface as they may cause pitting of the glass. • They must be removed immediately, even if the hob is still hot, taking care not to burn yourself. • Please be aware that pans with aluminium in the base can tend to leave marks on ceramic glass surfaces. • New hobs can sometimes show white 'bloom' marks which are related to manufacturing residues. • Apply some lemon juice to the glass surface and leave to soak for a while before cleaning with ceramic hob cleaner, rinsing and drying. • Do not clean ceramic hobs with washing-up liquid as it can sometimes leave behind a blue sheen. 	<ul style="list-style-type: none"> • Ceramic hob cream cleaner. • Microfibre cloths.
Chrome oven shelves, grill pan trivets, shelf guides and telescopic sliders	<ul style="list-style-type: none"> • Immerse a soft cloth in warm soapy water, wring out and wipe the shelves and shelf guides. • For heavier soiling, soak in warm soapy water, then clean with a non-scratch sponge. • Wave-shaped sponges can be useful for cleaning chrome shelves and grill pan trivets. • Wipe telescopic sliders with a damp cloth. Do not wash them in the dishwasher as the detergent will remove the lubricant from the runners which can prevent gliding and make them stiff. 	<ul style="list-style-type: none"> • Washing-up liquid. • Wave-shaped sponge.
Control knobs and bezels	<ul style="list-style-type: none"> • Wipe with a damp cloth. • On most models control knobs can be removed for more through cleaning in warm soapy water. • Please refer to the section for removing and replacing the knobs, bezels and the springs that go in between them. • It is a good idea to keep the user guide handy, or to take some photographs before you start removing the control knobs, so that you will 	<ul style="list-style-type: none"> • Washing-up liquid.

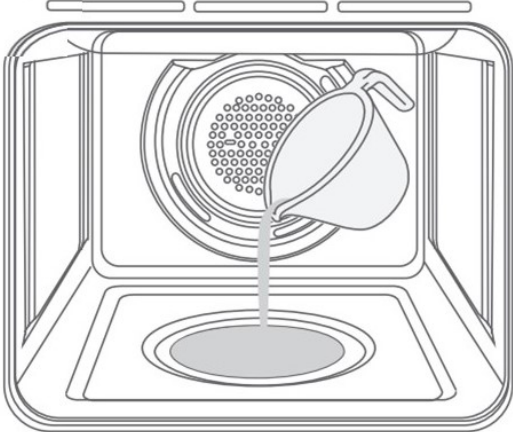
Area of appliance / material	Cleaning guidance	Example products
	<p>be able to see which knob and bezel goes in which position when you are refitting them.</p> <ul style="list-style-type: none"> Do not attempt to remove control knobs from pyrolytic oven models, or from models with retractable control knobs. 	
<p>Enamelled oven cavities - Steam Cleanse Method</p>	<ul style="list-style-type: none"> The Steam Cleanse Method can be used on oven cavities with recessed base wells in conventional (top and bottom) heating mode.  <ul style="list-style-type: none"> Firstly, please remove the oven shelves, shelf guides, grill pan and air fry tray as appropriate. Pour 200ml of cold water into the recess well at the bottom of the oven cavity and close the door. Select the conventional top and bottom heat function <input type="checkbox"/> (available on conventional ovens and multi-function ovens). Do not select any setting which uses the circulation fan, such as true fan oven mode <input checked="" type="checkbox"/>, as this could draw steam into the electrical parts of the appliance, possibly leading to operational faults. Turn the oven temperature selector to 90°C for 30-60 minutes to generate the steam. When the time has elapsed, switch the oven off and allow it to cool a little before wiping round the oven cavity with a damp sponge or cloth. The steam will make it easier to wipe away food residues and grease. Be sure to check that the oven has cooled sufficiently before starting to wipe round the oven cavity, and be aware that the upper element and base of the oven may still be hot. 	<ul style="list-style-type: none"> Microfibre cloths. Sponges.
<p>Enamelled oven cavities and grill pans</p>	<ul style="list-style-type: none"> Wash with warm soapy water. For heavier soiling, use a proprietary oven cleaner spray or gel, leave to work for as long as recommended in the instructions, then wipe away and rinse. 	<ul style="list-style-type: none"> Washing-up liquid. Proprietary oven cleaner. Non-stick PTFE cooking liners.

Area of appliance / material	Cleaning guidance	Example products
	<ul style="list-style-type: none"> • Do not allow oven cleaners to come into contact with stainless steel, aluminium or chrome parts, shelves, shelf supports, door seals, heating elements, or fascias with printed markings. • Do not allow fat to build up in grill pans and do not line grill pans with aluminium foil as this presents a risk of fire. • Grill pans can be lined with special non-stick PTFE cooking liners. • Non-stick PTFE cooking liners can reduce soiling in ovens. • Place these liners on the lower shelf, below the shelf where the food is being cooked, not on the floor of the oven cavity as this could block heat from the base element and cause damage. 	
Glass door parts	<ul style="list-style-type: none"> • Wash with warm soapy water. • To remove grease from inner glass panels, use a proprietary oven cleaner spray or gel, leave to work for as long as recommended in the instructions, then wipe away and rinse. • Polish with a soft microfibre cloth. • Do not allow oven cleaners to come into contact with stainless steel, aluminium or chrome parts, shelves, shelf supports, door seals, heating elements, or fascias with printed markings. 	<ul style="list-style-type: none"> • Washing-up liquid. • Proprietary oven cleaner. • Microfibre cloths.
Grill compartment	<ul style="list-style-type: none"> • It is a good idea to leave the grill element on for a few minutes after finishing cooking to burn off any grease on the heating element. • Do not leave a grill-pan containing grease under the grill element during this procedure. • Once the grill compartment has cooled down, it can be wiped down with a damp wrung-out cloth which has been soaked in warm soapy water. • Wave-shaped sponges can be useful for cleaning chrome shelves, grill pan trivets, and for cleaning the roof of the grill cavity, getting in between the grill element. 	<ul style="list-style-type: none"> • Washing-up liquid. • Wave-shaped sponges.
Rubber door seals	<ul style="list-style-type: none"> • Clean with warm soapy water. • Do not attempt to clean fibreglass door seals on pyrolytic ovens. 	<ul style="list-style-type: none"> • Washing-up liquid.
Steel - fascia control panels, electric hot-plate frames, door fronts	<ul style="list-style-type: none"> • Clean steel parts with warm soapy water and a soft sponge. • Do not scrub fascias / control panels as the markings could start to wear away. • Rinse with warm water and a soft cloth. • Polish dry with a microfibre cloth. 	<ul style="list-style-type: none"> • Washing-up liquid. • Microfibre cloths.

APPLIANCE MAINTENANCE

CHANGING THE LIGHTBULB

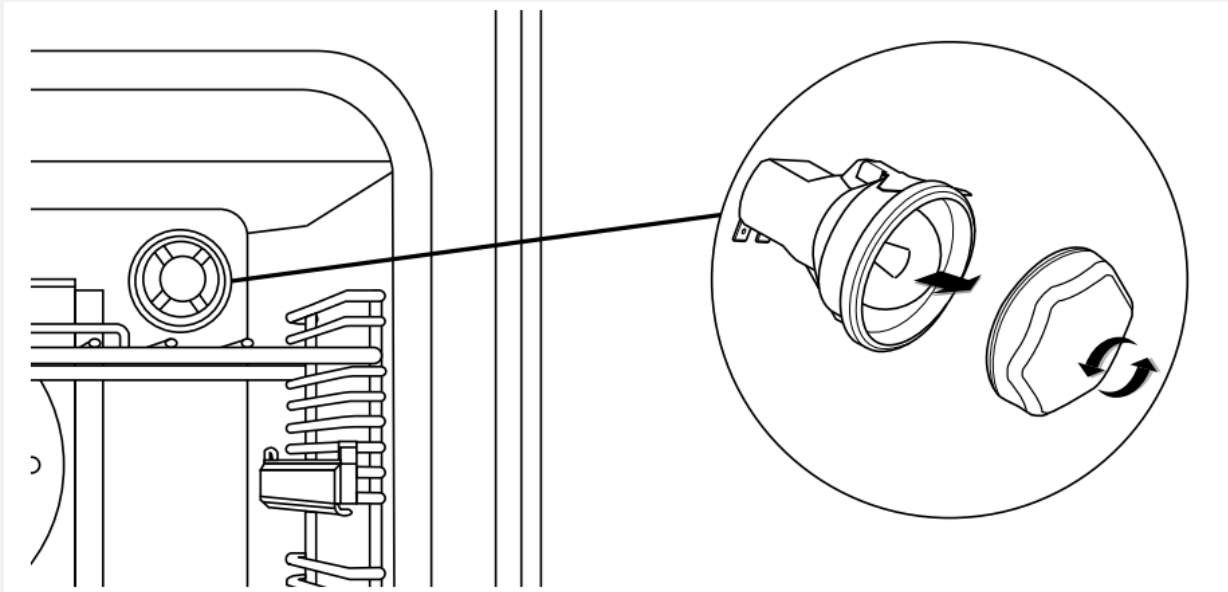

1. Switch the cooker off at the wall. Remove the oven shelves, grill pan and air fry tray.
2. Unscrew the lens cover by turning anticlockwise.
3. Remove the old bulb and replace it with a new one. Handle the new bulb with a piece of kitchen paper as skin oils can damage halogen bulbs.
4. Replace the lens cover and put the oven shelves back.



WARNING

Switch off the power before you change the light bulb.



NOTE

Not all appliances have the same number and type of bulbs. Before you replace your bulb, check to see what type you have. Usually a 25 watt G9 halogen capsule bulb - part number 082650920.

Please remember that bulbs are not covered by the manufacturer's warranty.

OVEN SHELVES

The oven shelves use anti-tip notches to prevent them being accidentally pulled out fully with hot food and cookware on them, to help prevent accidents.

Shelves With Anti-Tip Notches.

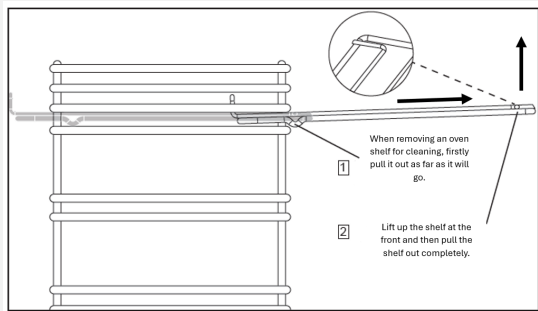

To remove the shelves fully, for cleaning or to reposition them, pull the shelf out as far as it will go, then lift upwards at the front to pull out fully.

Shelves.

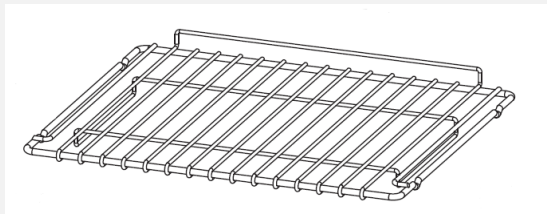

When inserting the shelves into the shelf guides, ensure that the upstand piece is at the back of the shelf and is pointing upwards.

Shelf Guides.

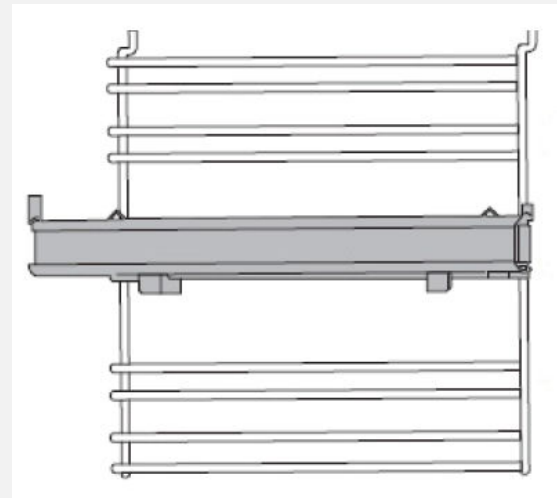

CAUTION

Each shelf guide position consists of an upper and a lower wire. Please insert the shelf between the two wires, and not sitting on top of the upper wire.

REMOVING AND REPLACING SHELF GUIDES

- The shelf guides have lugs which attach into holes on the side of the oven cavity.
- The shelf guide wires at the bottom clip under retainers to keep the shelf guides in position.
- The retainers look like small cotton reels or bobbins which are attached to the side of the oven cavity,

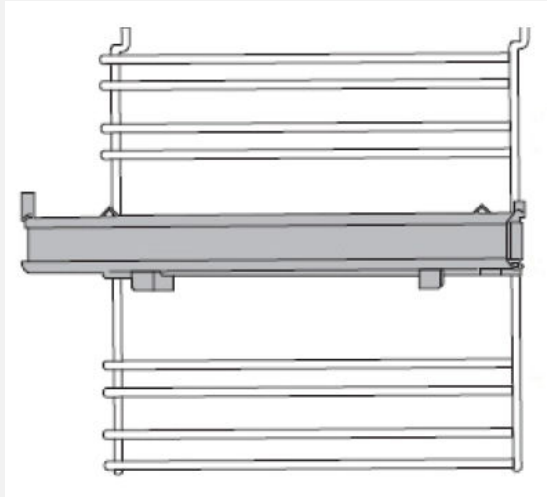

- To remove the shelf guides for cleaning, firstly please remove the shelves, grill pan and air fry tray as appropriate.
- Gently stretch the shelf guide wire at the bottom, pulling down and away from the retainer to release the wire from the retainer.
- The shelf guide can then be pulled away from the side of the oven cavity. The shelf guide lugs will come out of the holes in the side of the cavity.
- The shelf guide is replaced in the opposite manner.
- Insert the lugs into the holes on the side of the oven cavity.
- Then gently stretch the guide wire at the bottom to loop it under the retainer.

REPOSITIONING THE PRO-TRAC™ TELESCOPIC SLIDERS

- The Pro-Trac™ telescopic sliders can be used to support an oven shelf, a full-width grill-pan, or the air fryer basket.
- This allows the shelf, grill pan or air fryer basket to be slid out of the oven, fully supported by the sliders.
- This is ideal when adding, removing, turning, stirring or basting food, as you do not need to reach into a hot oven.
- The sliders clip on to the shelf guides, and so can be installed at any suitable shelf position in the main oven cavities.
- Always position the sliders on the shelf position required, while the oven is still cool, before starting to cook.
- Do not remove or reposition the sliders until the oven has cooled down after cooking.
- Do not wash the sliders in a dishwasher as the dishwasher detergent may remove the lubricant from the mechanism preventing the sliders from gliding smoothly.

REMOVING THE SLIDERS

- Firstly please extend the sliders fully and remove the shelves, grill-pan and air fry basket from the locating pins as appropriate.
- Place your fingers on the back of the tabs on the lower hooks at the bottom of the slider, and push upwards and outwards.

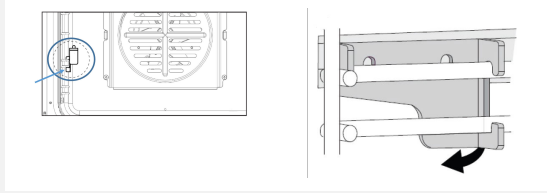

- Tilt the slider assembly upwards to about a 45 degree angle to disengage the lower hooks from the lower wire.
- Pull the slider assembly upwards to disengage the upper hooks from the upper wire.

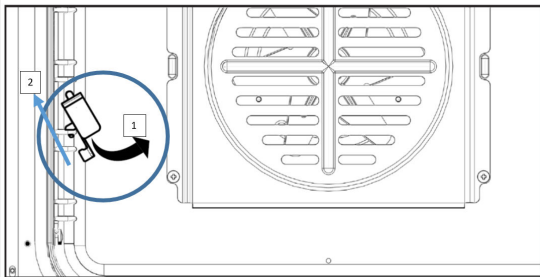

- Lift the slider assembly clear of the shelf guides.

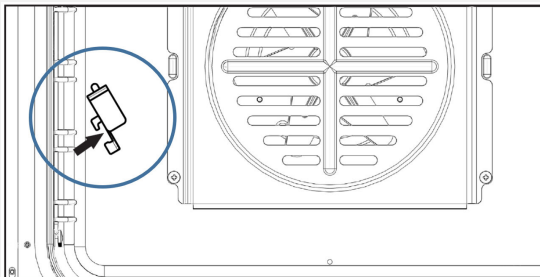

- Please repeat these steps for the slider assembly on the other side.
- The sliders have now been removed from the guides.

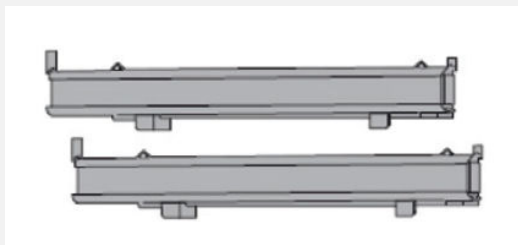

CHOOSING A SUITABLE POSITION FOR THE SLIDERS

- The telescopic sliders can be installed on any suitable shelf position on the wire shelf guides, that is in positions where the shelf guide runners are spaced well apart to allow room to install and remove the telescopic sliders.
- Please do not attempt to install the sliders in positions where the shelf guide runners are spaced close together, as it would be difficult to install and remove the telescopic sliders.

IDENTIFYING THE SLIDERS

- The extendable part of the slider must face forwards, with the locating pins pointing upwards, and with the hooks on the left for the left-hand slider and the hooks on the right for the right-hand slider.
- Each slider contains a set of hooks at the front and a set of hooks at the rear. In total, each slider assembly has 4 upper hooks and 2 lower hooks.

INSTALLING THE SLIDERS

- Firstly, please choose the shelf position that you wish to use.
- You will notice that each shelf position on the shelf guide consists of an upper wire and a lower wire. The wires curve round at the front and back to attach to the shelf guide.

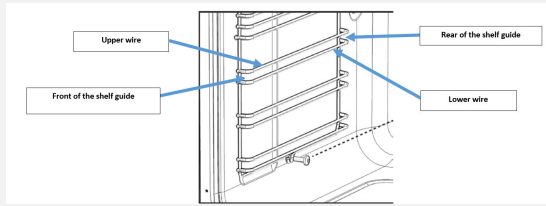

- Hold the telescopic slider assembly at about a 45 degree angle and clip the upper hooks over the upper wire.
- Ensure that all four of the upper hooks are clipped over the upper wire between the front and rear of the shelf guide.
- Then press the telescopic slider assembly firmly in towards the shelf guide, so that the two lower hooks engage with the lower wire.
- The slider has now been installed successfully and is ready to use.

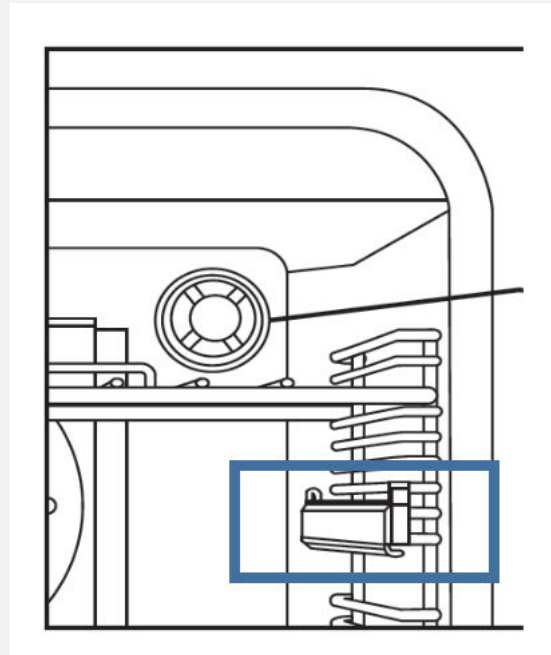

- Please repeat these steps for the slider on the other side of the cavity.

INSTALLING A SHELF, AIR FRY TRAY OR FULL-WIDTH GRILL-PAN ON THE SLIDERS

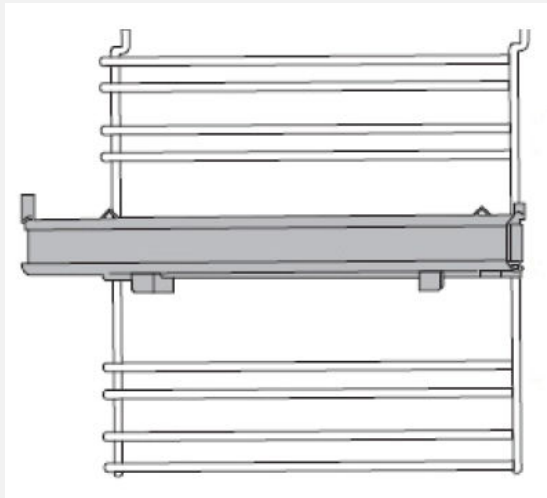

- Extend the sliders fully.
- Install the shelf, air fry tray or full-width grill-pan over the locating pins on the sliders.

Full-Width Grill-Pan On Sliders.

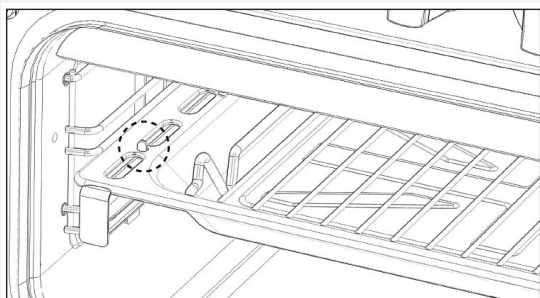

For installing the grill-pan, there are holes in the back-left and back-right of the grill-pan. Lower the grill-pan onto the fully-extended sliders ensuring that the locating pins on the slider engage with the holes on the grill-pan as shown.

Shelves On Sliders.

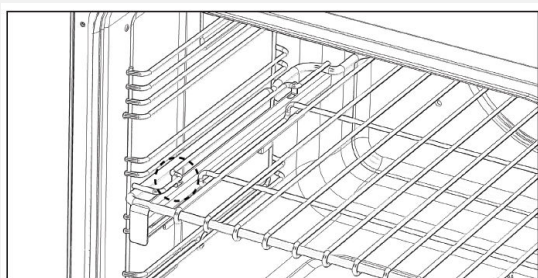

For installing the shelves, lay the shelf over the fully-extended sliders, ensuring that the slider locating pins are inside the front and back corners of the shelf.

Air-Fry Tray On Sliders.

For installing the air-fry tray, lay the tray over the fully-extended sliders, ensuring that the front slider locating pins are inside the front corners of the tray.

ORDERING ADDITIONAL PAIRS OF SLIDERS

- If you would like to purchase additional pairs of telescopic sliders, please visit the Spare Parts section of our website, using

the website address on the back cover.

- The left hand side slider is part number 094109802.
- The right hand side slider is part number 094109803.
- Please note, you will need 1 x 094109802 and 1 x 094109803 to make one pair of telescopic sliders.

REMOVING AND RE-FITTING CONTROL KNOBS, SPRINGS AND BEZELS

- The control knob assembly consists of the knob at the front, a bezel with markings around the knob, and a spring between the knob and the bezel.
- For cleaning, the bezels can be carefully slid forward to allow easy cleaning of the fascia control panel behind with a cloth.
- The bezels will spring back into position when you let go.
- For more thorough cleaning, the knobs, bezels and springs can be removed as follows.
- Firstly, please take a moment to note the positions of the different types of bezels on the cooker, take some photographs or have the appliance user guide handy. This will help you to replace the controls in the correct positions after cleaning.
- Ensure that all of the control knobs are in the 'off' position, and that the cooker is turned off at the wall.
- Push the control knob in towards the bezel.
- Then, holding the knob and bezel together, pull them both towards you and off the cooker spindle.

- **Be careful not to lose the spring, or the small silver clip which is inside the control knob shaft.**
- **To re-fit the control knobs, bezels and springs after cleaning, please follow these steps:**
- **Place the bezel face up on a surface.**
- **The flat side of the D-shaped hole and the printed dot for the 'off' position should be at the top.**
- **Place the spring over the hole in the middle of the bezel.**
- **Ensure that the knob is facing upwards, with the indicator mark at the top.**
- **Place the knob firmly over the spring, ensuring that the shaft on the back of the knob is located through the middle of the spring.**
- **The flat side of the D-shaped shaft at the back of the knob should be lined up with the flat side of the D-shaped hole in the middle of the bezel.**
- **Press down on the knob to push it into the bezel and keep it held down.**
- **The flat side of the D-shaped shaft at the back of the knob should be facing upwards.**
- **While holding the knob and bezel together, push the control knob assembly on to the cooker spindle.**
- **The cooker spindle is also D-shaped, so ensure that the flat side of the D-shaped shaft at the back of the knob is aligned with the flat side of the spindle.**
- **The control knob assembly has now been correctly installed and the controls can be used as normal.**

FAQs

For up-to-date frequently asked questions, please visit our Range Cookers FAQ page at:

[Range Cooker FAQs](#)

KEY PARTS AND OPTIONAL ACCESSORIES

Please see below for useful part numbers for your cooker, in case you require a replacement part or wish to purchase additional shelves or telescopic sliders, for example.

For any queries relating to parts missing on delivery of a new cooker, or relating to replacement parts during the manufacturer's warranty period, please contact our customer care team using the telephone number on the back cover.

To purchase additional shelves, sliders, consumables or parts outside of the manufacturer's warranty period, please refer to the Spare Parts section of our website - the website address is on the back cover.

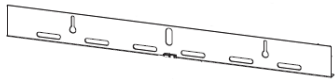
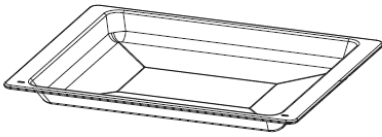
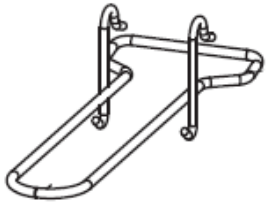
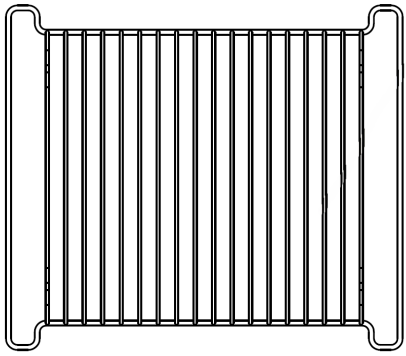
Part	Part Number	Notes
 <p>Air fry basket</p>	094108700	<p>Quantity 1 is supplied with the cooker.</p> <p>Used in the multi-function oven.</p>
Clip-in door seal - main oven (bottom-left)	094103502	Clips in - does not usually require an engineer service visit.
Clip-in door seal - top oven (top-left)	094103500	Clips in - does not usually require an engineer service visit.
Clip-in door seal - tall right hand oven	094103503	Clips in - does not usually require an engineer service visit.
 <p>Decorative cover plinth - black</p>	094108206 for 90cm wide cookers	<p>Quantity 1 is supplied with the cooker.</p> <p>Only required to be fitted if the cooker feet are fully extended to accommodate taller worktops.</p>
 <p>Deep grill pan</p>	094106100	<p>Quantity 1 is supplied with the cooker.</p> <p>Can be used in the top oven or main multi-function oven. (Cannot be used in the tall right-hand oven on 90cm models).</p>
 <p>Grill pan handle</p>	094111300	Quantity 1 is supplied with the cooker.
 <p>Grill pan trivet</p>	094117000	Quantity 1 is supplied with the cooker.

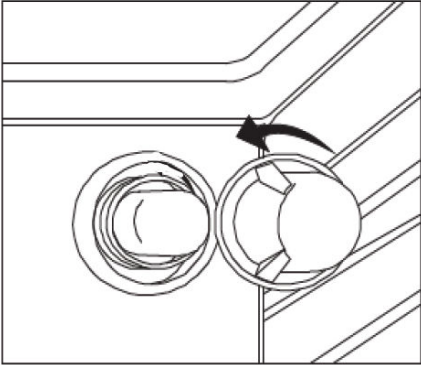
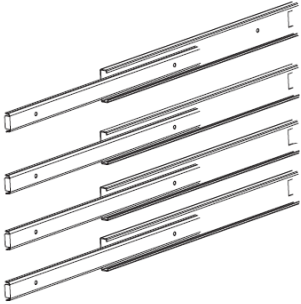
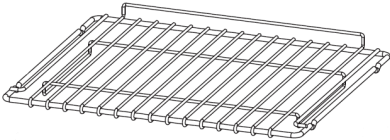
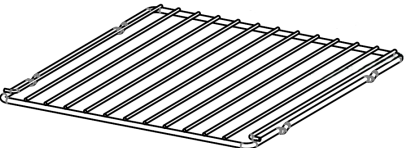
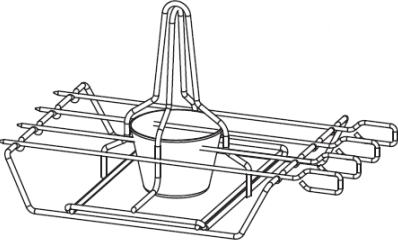
Part	Part Number	Notes
 <p data-bbox="209 660 331 685">Lamp bulb</p>	<p data-bbox="703 253 836 277">082650920</p>	<p data-bbox="1011 253 1366 309">Type - 25 watt G9 halogen capsule bulb.</p> <p data-bbox="1011 331 1374 412">Please note that replacement bulbs are not covered under the manufacturer's warranty.</p>
 <p data-bbox="209 1095 515 1120">Pro-Trac Telescopic Sliders</p>	<p data-bbox="703 696 943 752">Left hand side slider: 1 x 094109802</p> <p data-bbox="703 775 935 831">Right hand side slider: 1 x 094109803</p> <p data-bbox="703 853 951 958">You need 1 x 094109802 and 1 x 094109803 to make a pair.</p>	<p data-bbox="1011 696 1339 752">Quantity 4 pairs are supplied with the cooker.</p> <p data-bbox="1011 775 1366 855">Can be used in the top oven, main multi-function oven or the tall right-hand fanned oven.</p> <p data-bbox="1011 878 1366 958">Do not attempt to use them in positions where the shelf guide wires are close together.</p>
 <p data-bbox="209 1335 408 1359">Shelf (Deluxe 50)</p>	<p data-bbox="703 1133 831 1158">094108601</p>	<p data-bbox="1011 1133 1374 1189">Quantity 3 are supplied with the cooker.</p> <p data-bbox="1011 1211 1358 1267">Can be used in the top oven or multi-function oven.</p>
 <p data-bbox="209 1559 408 1583">Shelf (Deluxe 40)</p>	<p data-bbox="703 1373 831 1397">094108603</p>	<p data-bbox="1011 1373 1374 1429">Quantity 4 are supplied with the cooker.</p> <p data-bbox="1011 1451 1358 1507">Used in the tall right-hand fanned oven.</p>
 <p data-bbox="209 1901 619 1957">Steam & Infuse Kit (Vertical roasting system)</p>	<p data-bbox="703 1597 836 1621">094109600</p>	<p data-bbox="1011 1597 1366 1677">Quantity 1 is supplied with Stoves Deluxe (DX) range cookers.</p> <p data-bbox="1011 1709 1366 1789">Can be purchased as an optional extra for Stoves Core range cookers.</p> <p data-bbox="1011 1821 1358 1951">Can be used in the multi-function oven (in true fan oven mode). (Cannot be used in the tall right-hand oven on 90cm models).</p>

TECHNICAL DATA



WARNING

This cooker must be earthed.

Data badge	Lower part of the front frame
Appliance class	Class 1 - freestanding cooker
Electrical supply	230 - 400V ~3N ~ 50 Hz
Load	15780W (Induction Unit 7400W)
Standard Oven Light	25W

Hob Top Hotplate	Electrical Supply	Zone Load (W)
Induction	230V	Left hand front 1600W (3000W Boost)
		Left hand rear 1600W (3000W Boost)
		Right hand front 1150W (2200W Boost)
		Right hand rear 1400W (3000W Boost)
		Centre cavity 2300W (3700W Boost)

Appliance Electrical Supply	Oven Cavity & Function Load (W)
230V	Main Oven: Digital MF Oven- Air Fry 3166W
	Pro-Flex Tall Oven 2658W
	Top Cavity: Dual Grill 2504W

ENERGY DATA TABLE

Regulation (EU) 65/2014:

Product Name: Stoves Richmond DX 90CM Electric Induction (Rotary Controls)	
Brand:	Stoves
Size:	90cm
Number of cavities	3

Energy Efficiency

Hob		
Fuel Type	Induction	
Number of cook zones	5 Electric Zones	
	Symbol	Value
Energy Efficiency per cook zone		Cook zone
	Electric Zone	Zone 1: 215cm* 390cm /180 192.7Wh/kg
		Zone 2: 215cm*390cm/150 186.4Wh/kg
		Zone 3 (Bridged Area Data): 215cm*390cm/210 200Wh/kg
		Zone 4: 230cm/240cm 188.9Wh/kg
		Zone 5: 200cm/210cm 180Wh/kg
		Zone 6: 165cm/180cm 194Wh/kg
EE Electric Hob	All Induction Cook Zones 190.3Wh/kg	

Energy Efficiency

Cavity	Cavity 1	Cavity 2	Cavity 3 (if applicable)
Energy efficiency index	91,3	92,5	93,3
Energy efficiency class	A	A	A
Energy Consumption per cycle (conventional mode)	0,63 kWh	0,83 kWh	N/A
Energy Consumption per cycle (fan-forced convection mode)	N/A	0,74 kWh	0,83 kWh
Heat Source	Electric	Electric	Electric
Volume	33 Litres	60 Litres	81 Litres
<i>Energy consumption measured in accordance with BS EN 60350-1</i>			

SERVICE CONTACT DETAILS

<p>Australia</p> <p>Customer Care Tel: +61 1800 444 357</p> <p>General Enquiries Tel: +61 1300 556 816</p> <p>https://www.belling.com.au/en-au/support/contact-us</p> <p>www.belling.com.au</p> <p>Glen Dimplex Australia, 8 Lakeview Drive, Scoresby, VIC 3179, Australia</p>	<p>Ireland</p> <p>Tel: +353 (0) 1 8428222</p> <p>Service e-mail: serviceireland@glendimplex.com</p> <p>Spare parts enquiries e-mail: sparesireland@glendimplex.com</p> <p>www.glendimplexireland.com</p> <p>Glen Dimplex Ireland UC, Airport Road, Cloghran, Co. Dublin, K67 DT89</p>
<p>New Zealand</p> <p>Tel: +64 (0) 9 274 8265</p> <p>https://www.belling.co.nz/en-nz/support/contact-us</p> <p>www.belling.co.nz</p> <p>Glen Dimplex New Zealand, PO Box 58473 Botany, Auckland 2163, New Zealand</p>	<p>United Kingdom</p> <p>Stoves Service Tel: +44 (0) 344 815 3740</p> <p>www.stoves.co.uk</p> <p>Belling Service Tel: +44 (0) 344 815 3746</p> <p>www.belling.co.uk</p> <p>Glen Dimplex Home Appliances, Element, Temple Court, Risley, Warrington, WA3 6GD</p>



**Glen Dimplex Home Appliances, Element, Temple Court, Risley,
Warrington, WA3 6GD.**

0344 815 3740

www.stoves.co.uk

GDHA Part Number: 094113101