



belling

**INSIDE
EVERY
GREAT
HOME**



User Manual

Belling Built In Fanned 60cm

www.belling.co.uk

Date: 18/05/19

Countries of destination:

GB - Great Britain
IE - Ireland
DE - Germany
ES - Spain

FR - French
IT - Italy
PL - Poland
NL - Netherlands

SE - Sweden
CN - China
NZ - New Zealand
AU - Australia

To contact Belling about your appliance, please call:



Customer Care Helpline
0344 815 3746

in case of difficulty within the UK



Warranty Registration
0800 952 1068

*Please call our Customer Care team for extended warranty



Spares Store
0344 815 3745



To register your appliance online:
www.belling.co.uk



To contact us by email:
gdhainfo@gdha.com



To register your appliance by mail:
**Please complete the warranty card
and return to the address supplied**



Alternatively general, spares and service information is available from
our website at: **www.belling.co.uk**

Calls are charged at the basic rate, please check with your telephone service provider for exact charges

Your new appliance comes with our **12-month guarantee**, protecting you against electrical and mechanical breakdown. To register, please complete the registration form included, register online or by phone. For full terms & conditions of the manufacturer's guarantee, please refer to the website above. In addition, you may wish to purchase an extended warranty. A leaflet explaining how to do this is included with your appliance.

Our policy is one of constant development and improvement, therefore we cannot guarantee the strict accuracy of all of our illustrations and specifications. Changes may have been made subsequent to publishing.

Glen Dimplex Home Appliances, Stoney Lane, Prescot, Merseyside, L35 2XW

INTRODUCTION

ACKNOWLEDGEMENT

Thank you for purchasing our product. We hope you enjoy using the many features and benefits it provides.

This user guide book is designed to help you through each step of owning your new product.

Please read it carefully before you start using your appliance, as we have endeavored to answer as many questions as possible, and provide you with as much support as we can.

General information, spares and service information is available from our website.

Ensure that other people using the product are familiar with these instructions as well.

If you should find something missing from your product or have any questions that are not covered in this user guide, please contact us (see contact information inside the front cover).

European Directives



This appliance is marked according to the European directive 2012/19/EU on Waste Electrical and Electronic Equipment (WEEE).

By ensuring this product is disposed of correctly, you will help prevent potential negative consequences for the environment and human health, which could otherwise be caused by inappropriate waste handling of this product. The symbol on the product indicates that this product may not be treated as household waste. Instead it shall be handed over to the applicable collection point for the recycling of electrical and electronic equipment. Disposal must be carried out in accordance with local environmental regulations for waste disposal. For more detailed information about treatment, recovery and recycling of this product, please contact your local city office, your household waste disposal service or the shop where you purchased the product

This appliance conforms to European Directive regarding Eco design requirements for energy-related products.

Hereby, Glen Dimplex Home Appliances Ltd. declares that the radio equipment types BEL BI602FPCT is in compliance with Directive 2014/53/EU. The full text of the EU declaration of conformity is available at the following internet address: www.belling.co.uk in the online user manual for this appliance.

DECLARATION OF COMPLIANCE

When you have unpacked the oven, make sure that it has not been damaged in any way. If you have any doubts at all, do not use it: contact a professionally qualified person. Keep packing materials such as plastic bags, polystyrene, or nails out of the reach of children because these are dangerous to children.



UK ONLY GAS WARNING:

If you smell gas, Do not try to light any appliance. Do not touch any electrical switch.
Call the Gas Emergency Help line at **0800 111999**

SAFETY

WARNING

- During use the appliance becomes hot. Care should be taken to avoid touching heating elements.
- Children less than 8 years of age shall be kept away unless continuously supervised. This appliance can be used by children aged from 8 years and above and persons with reduced physical sensory or mental capabilities or lack of experience and knowledge if they have been given supervision or instruction concerning the use of the appliance in a safe way and understand the hazards involved. Children shall not play with the appliance. Cleaning and user maintenance shall not be made by children without supervision.
- Do not use harsh abrasive cleaners or sharp metal scrapers to clean the oven door glass since they can scratch the surface, which may result in shattering of the glass.
- Do not use a steam cleaner on any range cooker, hobs and oven appliances.
- Ensure that the appliance is switched off before replacing the lamp to avoid electric shock.
- Never put items directly on the base of the oven or cover the oven base with foil, as this can cause the base element to overheat.
- When the oven is first switched on, it may give off an unpleasant smell. Please use the conventional or fanned cooking function at 250°C for 90 minutes to clean oil impurities inside the cavity. Ensure that the room is well ventilated during this process.
- Do not allow children to go near the oven when it is operating, especially when the grill is on.
- The means for disconnection must, be incorporated in the fixed wiring in accordance with the wiring specifications
- An all-pole disconnection means must be incorporated in the fixed wiring in accordance with the wiring rules in force
- If the supply cord is damaged, it must be replaced by the manufacturer, its service agent or similarly qualified persons in order to avoid a hazard.
- This appliance must be fitted to a switch providing all pole

disconnection with a minimum contact separation of 3mm.

- Connection should be made with a suitable flexible cable with a minimum temperature rating of 70°C.
- Although every care has been taken to ensure this appliance has no sharp edges. We recommend that you wear protective gloves when installing and moving this appliance. This will prevent injury.
- Always switch off your appliance and allow it to cool down before you clean any part of it.

CAUTION

- This appliance must not be installed behind a decorative door in order to avoid overheating.
- The cooking process has to be supervised. A short term cooking process has to be supervised continuously.
- Ensure shelving is correctly installed, see the sections on shelf runners and shelf location within this book

• **Fire Safety Advice**

If you do have a fire in the kitchen, don't take any risks - get everyone out of your home and call the Fire Brigade.

If you have an electrical fire in the kitchen:

- Pull the plug out, or switch off the power at the fuse box - this may be enough to stop the fire immediately
- Smother the fire with a fire blanket, or use a dry powder or carbon dioxide extinguisher
- Remember: never use water on an electrical or cooking oil fire.

• **Other Safety Advice**

- Servicing should be carried out only by authorised personnel.
- Do not operate the appliance without the glass panels correctly fitted.
- There is a risk of electric shock, so always make sure you have turned off and unplugged your appliance before starting any cleaning or maintenance. Always allow the product to cool down before you change a bulb.
- Do not modify the outer panels of this appliance in any way.
- This appliance must be earthed.
- The appliance must never be disconnected from the mains supply during use, as this will seriously affect the safety and performance, particularly in relation to surface temperatures becoming hot and gas operated parts not working efficiently. The cooling fan (if fitted) is designed to run on after the control knob has been switched off.

- **GAS WARNING!** - If you smell gas: Do not try to light any appliance, Do not touch any electrical switch. Contact your local gas supplier immediately.

USING YOUR APPLIANCE





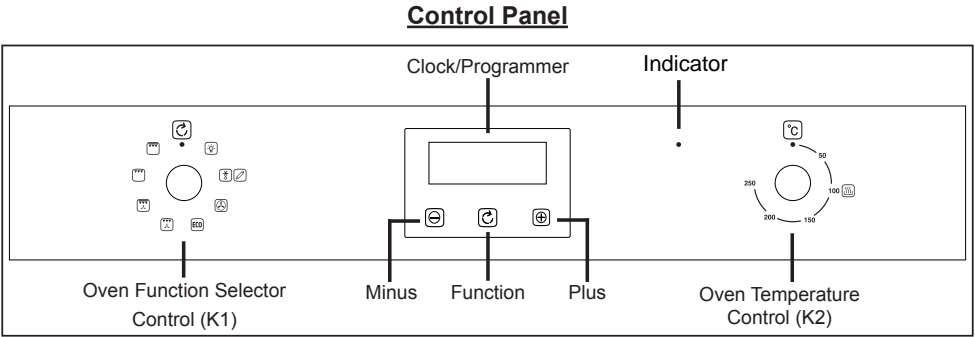



Getting to know your product

Note: Your appliance layout may differ depending on the model.



Oven / Grill functions

Note: Your oven may not have all of the functions shown here. We recommend for best cooking results, please preheat for 15 minutes.

Symbol	Function Description
	Oven Lamp:- Can be operated on its own for cleaning or maintenance without any heating elements coming on. The Oven lamp will also come on when any oven function is selected. except ECO function
	Defrost and Dough Proving:- Can be used to gently defrost frozen foods, This setting can also be used to help dough to rise faster than at room temperature.
	Fanned Oven:- The even temperature in the oven makes this function suitable for batch baking, or batch cooking foods.
	Fanned Grill:- The fan forces air around the food and is ideal for thinner foods such as bacon, fish and gammon steaks. Foods require less turning. Use this function with the oven door closed.
	Fanned Dual Grill:- The fan forces air around the food and is ideal for thinner foods such as bacon, fish and gammon steaks. Foods require less turning. Use this function with the oven door closed.
	Single Grill:- The central area under the grill becomes hot and is ideal for toasting and grilling meats such as sausages, chops and steaks. Use with the door closed. Place food in the middle of the grill pan.
	Dual Grill:- Operates inner and outer grill elements. This function is useful for toasting and grilling thinner meats, like bacon. Use with the door closed. Place food in the middle part of the grill pan.
	Slow Cook:- Provides a gentle heat suitable for slow cooking or keeping food warm. Select the conventional cooking function and set the temperature to 100°C.
	The even temperature in the oven makes this function suitable for batch baking, or batch cooking foods.

Oven

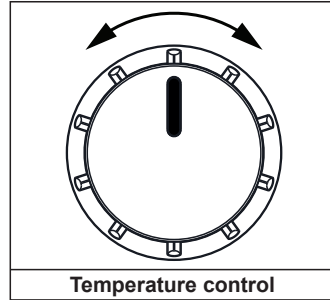
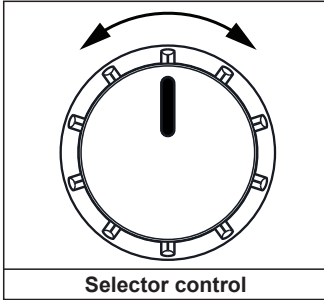

Cooling Fan

When cooking is finished, paused, or if the central oven temperature is over 75°C, the cooling fan will continue working for around 15 minutes. When the central oven temperature drops below 75°C, the cooling fan will stop.

To use your appliance





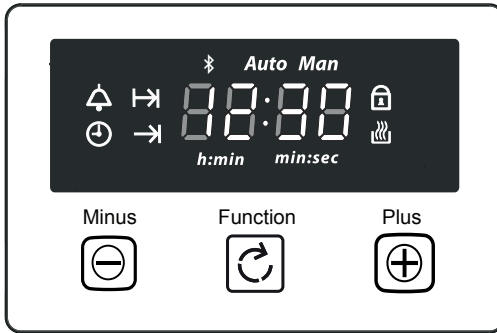

To select a Cooking Function and Cooking Temperature

1. Begin by turning K1 to the desired cooking function. The functions are shown on the appliance facia.
2. Rotate K2 to select the desired cooking temperature. This can be adjusted during use.

Clock/Programmer

Note: The image below is a generic timer image, your clock / programmer may not have all these functions.



	Minute minder	Man	Manual mode
	Cooking time / Duration	L 1.1.2.1.3	Volume level
	End of cooking time	23:59	7-segment display
	Clock Symbol	99:00	Max. adjustable minute minder
	Keylock	23:59	Max. adjustable cooking time
	Cookpot Symbol	h:min	Display hours:minutes
Auto	Automatic mode	min:sec	Display minutes:seconds
	Bluetooth Symbol (If fitted)		

Setting the Time of Day

This can be done when the appliance is first connected to the power supply or at any point afterwards providing the oven is in standby (i.e not operating)

The clock is displayed as “hh:mm” and is a 24 hour clock.

1. Press the function key repeatedly until the clock symbol flashes.
2. While the clock symbol is flashing, use the plus and/or minus keys to set the current time of day.
3. About 7 seconds after the last press of the plus or minus key, the clock symbol stops flashing and the time of day has been accepted.

Note: Always set the time of day before using the automatic cooking programme, because if you change the time of day after setting an automatic cooking programme, then the automatic cooking programme will be cancelled.

Note: If the clock is not set when first connected to the power, it will display 00:00.

Setting the Minute minder

The minute minder does not switch the oven off automatically. A minute minder duration time of between 1 minute and 99 minutes can be selected.

The clock is displayed as "h:mm".

1. Press the function key repeatedly until the Minute minder symbol starts to flash.
2. While the Minute minder symbol is flashing, use the plus and/or minus keys to set the required minute minder duration time.
3. About 7 seconds after the last press of the plus or minus key, the minute minder duration time is accepted and starts to count down.

Check or modify the Minute minder

1. Press the function key repeatedly until the Minute minder symbol starts flashing again and the remaining minute minder duration time is displayed.
2. While the Minute minder symbol is flashing, you can press the plus and/or minus keys to adjust the minute minder duration time.

Cancel the Minute minder

1. Adjusting the minute minder duration time down to zero would cancel the minute minder function.
2. About 7 seconds after the last press of the plus or minus key, the updated minute minder duration time is accepted and starts to count down.
3. When the minute minder duration time has elapsed, the buzzer will sound. Press the function key to silence the alarm and the display returns to showing the current time of day. If you do not silence the alarm, it will be silenced automatically after approximately 7 minutes.

Manual operation of the oven

If the programmer is not in semi-automatic or fully-automatic mode you can use oven functions manually. The **Man** icon will appear on the display screen.

Semi-automatic cooking

Semi-automatic cooking allows the main oven to switch off automatically after a specified time.

Note: Make sure that the correct time of day has been set on the timer.

1. Place the food in the main oven, and select the cooking function and temperature.
2. Press the function key repeatedly until the 'cooking duration' symbol \rightarrow starts to flash.
3. While the cooking duration time symbol is flashing, use the plus and/or minus keys to set the required cooking duration time. A duration time of between 1 minute and 23 hours 59 minutes can be set.
4. About 7 seconds after the last press of the plus or minus key, the cooking duration time is set and begins to count down. The 'Auto' symbol and 'Cookpot' symbol light up in the timer display.

Check, modify or cancel the cooking duration time

1. If you need to check or change the cooking duration time, press the function key repeatedly until the cooking duration time symbol starts flashing again, and the remaining cooking duration time is displayed.
2. While the cooking duration time symbol is flashing, press the plus and/or minus keys repeatedly to adjust the cooking duration time.
3. Adjusting the cooking duration time down to zero would cancel the semi-automatic cooking function.
4. About 7 seconds after the last press of the plus or minus key, the updated cooking duration time is set and begins to count down.

When the cooking duration time has elapsed, the buzzer sounds and the 'Man' icon starts to flash.

1. Turn the function knob and the thermostat knob back to the off position.
2. Press the function key once to silence the buzzer. If you do not silence the buzzer, it will be silenced automatically after about 7 minutes.
3. Press the function key again and the 'Man' symbol lights up steadily to show that the main oven is back in manual mode.

Fully Automatic cooking

Fully-automatic cooking allows the main oven to switch on and off automatically. You can enter the 'cooking duration time' and the time at which you want the food to be ready, and the timer will calculate the start time.

Note: Make sure that the correct time of day has been set on the timer.

1. Place food in the oven.
2. Press the function key repeatedly until the cooking duration time symbol \rightarrow starts to flash.
3. While the cooking duration time symbol is flashing, use the plus and/or minus keys to set the required cooking duration time. A duration time of between 1 minute and 23 hours 59 minutes can be set.
4. About 7 seconds after the last press of the plus or minus key, the cooking duration time is set. The 'Auto' symbol and 'cookpot' symbol light up in the timer display.
5. Press the function key repeatedly until the 'cooking end time' symbol \rightarrow starts to flash.
6. While the cooking end time symbol is flashing, use the plus and/or minus keys to set the required cooking end time. A cooking end time can be selected up to 23 hours and 59 minutes after the 'current time of day'.
7. Select the cooking function and temperature as usual.

The 'Auto' symbol remains lit up, but the 'cookpot' symbol goes out, this indicates that the cooking start time has not yet been reached.

Check, modify or cancel the cooking duration time

1. If you need to check, change or cancel the cooking duration time, press the function key repeatedly until the cooking duration time symbol starts flashing again, and the cooking duration time is displayed.
2. While the cooking duration time symbol is flashing, you can use the plus and/or minus keys to adjust the cooking duration time.

Check, modify or cancel the cooking end time

1. If you need to check, change or cancel the cooking end time, press the function key repeatedly until the →| symbol starts flashing again, and the cooking end time is displayed.
2. While the cooking end time symbol is flashing, you can use the plus and/or minus keys to adjust the cooking end time.
3. About 7 seconds after the last press of the plus or minus key, the updated cooking duration time and/or cooking end time is set.

Adjusting both the cooking duration time down to zero and the cooking end time down to the 'current time of day', would cancel the fully-automatic cooking function.

When the calculated start time arrives, the oven heating is switched on and the 'cookpot' symbol appears in the timer display.

When the cooking end time arrives, the buzzer sounds. The 'Man' icon starts to flash.

1. Turn the function knob and the thermostat knob back to the off position.
2. Press the function key once to silence the buzzer. If you do not silence the buzzer, it will be silenced automatically after about 7 minutes.
3. Press the function key again and the 'Man' symbol lights up steadily to show that the main oven is back in manual mode.

Selecting the buzzer volume

1. Press the function key repeatedly until 'L1', 'L2' or 'L3' appears on the timer display.
2. While 'L1', 'L2' or 'L3' appears on the display, use the plus and/or minus keys to adjust the buzzer volume, with L1 being the quietest tone and L3 being the loudest tone.
3. About 7 seconds after the last press of the plus or minus key, the selected buzzer volume is stored in the memory.

Activating and deactivating the child lock

To activate the child-lock

1. While the timer is not being used to adjust any other function, press and hold the plus key for about 5 seconds until the padlock symbol appears in the display.
2. While the child-lock is active, pressing the timer keys has no effect.

Note: If a semi-automatic or fully-automatic cooking programme is currently in progress, the child lock function cannot be modified or cancelled and the cooking programme will run through to the end.

To de-activate the child-lock

1. While the timer is not being used to adjust any other function, press and hold the plus key for about 5 seconds until the padlock symbol disappears from the display.

Bluetooth Connectivity (If fitted)

State of Connectivity Symbol

- When the connectivity symbol is not present, the appliance cannot be connected to.
- When the connectivity symbol is blinking, the appliance is ready to be paired with a smart device using the Zeus App.
- When the connectivity symbol is solid, the appliance is connected to a smart device and the timer can be set using the Zeus app.

Activating / deactivating the bluetooth connectivity

1 Press and hold the function key for 5 seconds until a beep is heard



2 The connectivity symbol will start flashing. The timer is now ready to be connected to a smart device



3 Press and hold the function key for 5 seconds to deactivate the bluetooth connectivity function. The connectivity symbol will disappear.



Clear Memory

Note: If connection difficulties are experienced, it can be helpful to clear the bluetooth pairing between the timer and the smart device. After the pairing has been cleared, the connection can be reestablished from the beginning.

- 1** Press the function and plus keys at the same time until a beep is heard.

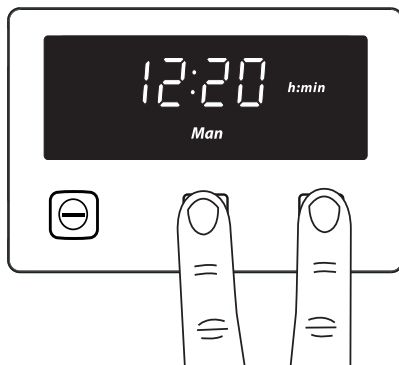

Once the beep is heard, any paired data will be cleared.

Delete pairing information in the Bluetooth Settings of your smartphone or tablet (the 'unpair' or 'forget this device' option).

How to read the 6-digit pairing code

1. When the smart device connects to the appliance through the Zeus App, the App will ask for a unique pairing code that will be displayed on the timer.

Note: Every time a new smart device connects through the Zeus App to the appliance, a different pairing code is displayed.

2. When prompted to enter the 6-digit code, the code will appear on the timer.

The 6-digit code will scroll across the timer display from the right to the left.

Note: Be aware that the display can only show four digits at a time.

Please refer to the website at the front of this guide for more information or download the Zeus Appliance control App (Available on iPhone and Android)

Soft Closing Door (If fitted)

The door can be paused at any angle greater than 30°.

The door will close slowly under the action of the damper, if it is less than or equal to an angle of 30°.

Please do not close the door vigorously.

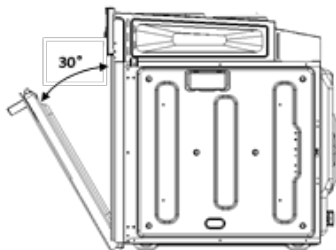

Catalytic Oven liners (If fitted)

Some oven specifications have catalytic oven liners fitted to the sides of the oven, you can easily tell if they are fitted because the panel is a light grey soft touch enamel. This enamel is special and partly cleans itself. This does not stop all marks on the lining, but helps to reduce the amount of manual cleaning needed.

These panels work best when the oven is heated above 200°C. If you do most of your cooking below this temperature, occasionally wipe the panels with a lint free cloth and hot soapy water. The panels should then be allowed to dry naturally and the oven heated at 200°C for about one hour. This will make sure that the panels are working effectively.

Do not use harsh abrasives or chemicals on this soft enamel.

Removing the door from oven (optional)

1. To remove the door, open the door to the maximum angle. Then pull the catches on each hinge forward towards you.

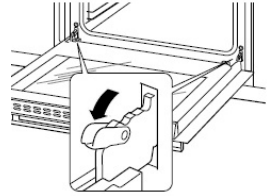

2. Close the door to an angle approximately 30°. Hold the door with one hand on each side. Lift up and slowly pull the door out from the oven. Do not lift the door assembly by the handle.

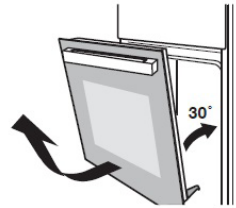

3. When the door is fully open or has been removed from the main body of the oven, you will see black latches on the left-hand-side and right-hand-side close to the hinges. Carefully push these latches outward.



4. Lift up the door inner glass and pull it out, then take the door middle glass out in the same way. Please take care when removing the glass panels while the door is still attached to the oven as the door may spring back when the weight of the glass is removed.

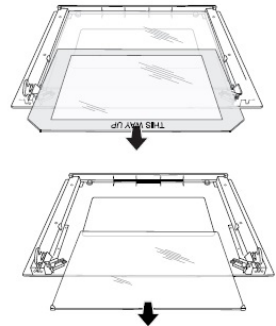

To reassemble, follow the instructions in reverse, ensuring the glass is re-installed the right way up, the hinges are aligned with the hinge receivers and locating cables are in the fully home position.

WARNING: Do not forcibly pull on the oven door as this could result in the glass shattering during the dismantling process.

WARNING: The hinge springs could loosen, causing personal injury. Do not touch the hinges.

WARNING: Do not lift or carry the oven door by the door handle.

Accessories

Wire shelf: For dishes, cake pan with items for roasting and baking.

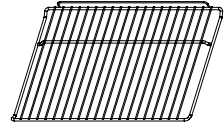

Shelf support rails: Used to support the wire shelf and grill pan if required. These shelf support rails on the right and left sides of the oven can be removed. (only for specific models)

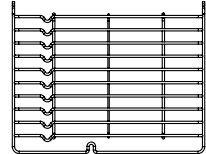

Grill pan: For cooking large quantities of food such as moist cakes, pastries, frozen food etc, or for collecting fat/ spillage and meat juices. This can also be used as a roasting tin and a baking sheet.

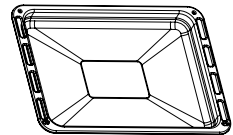

Telescopic runner (if fitted): Some models might come with telescopic runners to facilitate the use of oven. These telescopic runners and slider brackets could be disassembled by unscrewing the screws used to fix it. (only for specific models)

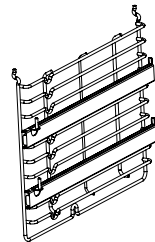

Shelf placement warning:

To ensure the oven shelves operate safely, correct placement of the shelves between the side rails is imperative. Shelves and the grill pan can only be used between the first and fifth layers.

Ensure that shelves are inserted correctly, with the upstand at the back and pointing upwards. This will help to prevent the shelves tipping forwards when they are pulled out.

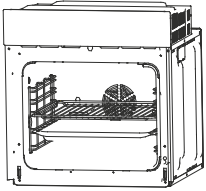

OR

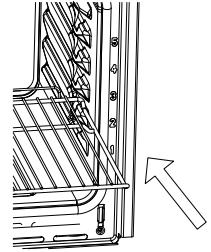
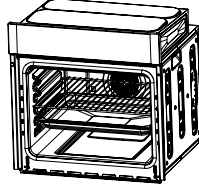

Removing Shelf Runners

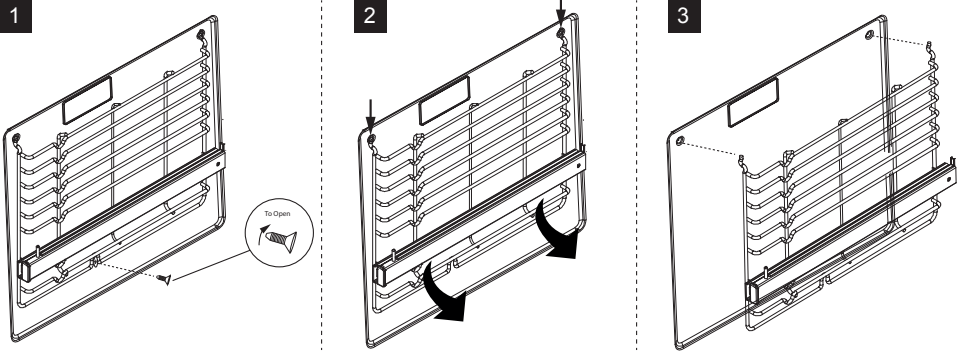

Standard shelves

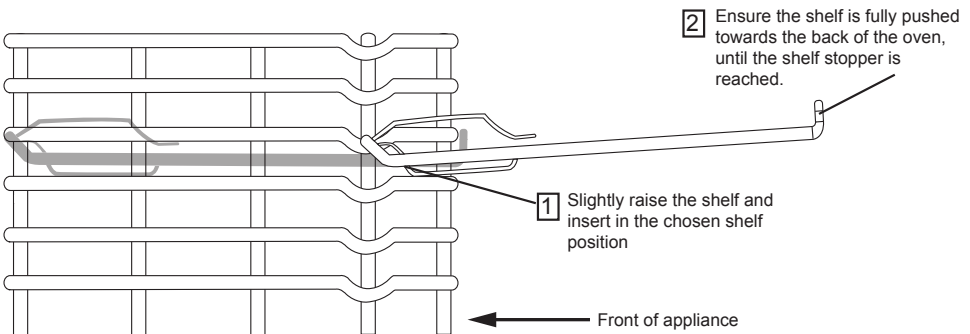

The oven shelves can also be hooked onto the shelf runners (where fitted)

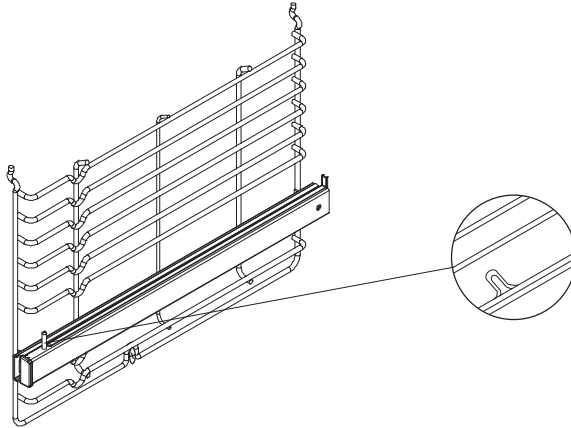

Before removing the shelves completely, please make sure that the shelf is unclipped from the retaining tabs.

BULB REPLACEMENT

Risk of electric shock!

Glass cover

You must replace a damaged glass cover. Suitable glass covers may be obtained from the after-sales service.

For replacement, proceed as follows:

1. Disconnect power from the mains outlet or switch off the circuit breaker of the unit's mains outlet.
2. Unscrew the glass lamp cover by turning it counter-clockwise (note, it may be stiff) and replace the bulb with a new one of the same type.
3. Screw the glass lamp cover back in place.

Note: Only use 25-40W/220V-240V, T300°C halogen lamps

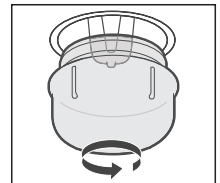

CLEANING YOUR APPLIANCE

Do's

Note: Always switch off your appliance and allow it to cool down before you clean any part of it.

Note: Please take extra care when cleaning over the symbols on the control panel, as this can lead to them fading.

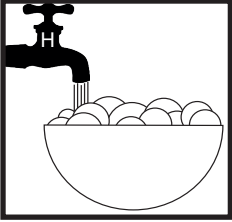

- Warm, soapy water

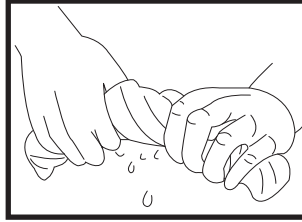

- Clean, wring out cloth

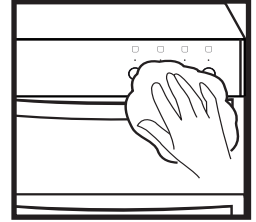

- Wipe with damp cloth
- Dry with a soft cloth

Tips: Some foods can mark or damage the metal or paint work e.g.; Vinegar, fruit juices and salt. Always clean food spillages as soon as possible.

Dont's

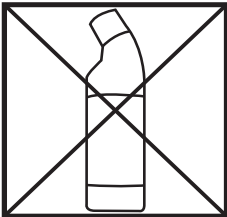

- Undiluted bleaches
- Chloride products

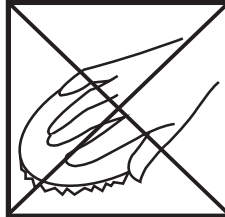

- Wire Wool
- Abrasive cleaners
- Nylon pads
- Steam cleaners

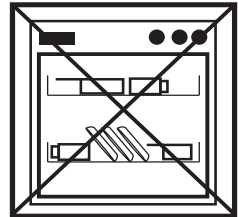

- Do not place in the dishwasher:
- Cast iron griddle
 - Pan supports

IT IS IMPORTANT TO CLEAN YOUR APPLIANCE REGULARLY AS A BUILD UP OF FAT CAN AFFECT IT'S PERFORMANCE OR DAMAGE IT AND MAY INVALIDATE YOUR GUARANTEE.

IN ADDITION TO THE ABOVE, DO NOT USE METAL SCRAPERS TO CLEAN THE OVEN DOOR GLASS.

We offer a great range of cleaning products and accessories for your appliance.
To shop, please visit our website located at the front of this User Guide.

Please keep this handbook for future reference, or for anyone else who may use the appliance.

Please keep this handbook for future reference, or for anyone else who may use the appliance.

Please keep this handbook for future reference, or for anyone else who may use the appliance.

Customer Care

Please keep this handbook in a safe place as the information inside may be of use should you sell, or pass on the appliance. Please fill in the model number and serial number in the spaces provided below as they will assist us should you need to call.

0344 815 3746

When you dial this number, you will hear a recorded message and be given several options. This indicates that your call has been accepted and is being held in a queue. Calls are answered in strict rotation as our Customer Care representatives become available.

Enter appliance numbers here for future reference:

Model No									
4	4	4							
Serial No									

These numbers can be found on your appliances data badge. Outside the UK and Northern Ireland, refer to your local supplier.



Stoney Lane, Prescot, Merseyside, L35 2XW.

TECHNICAL DATA

Electric Built In

Electrical supply / Load		
Appliance Size (cm)	Electrical supply	Load (kW)
60 Fanned Oven	220 - 240V ~ 50Hz	2.7

For the specific power rating of your model, refer to the data badge on the front frame of your appliance.

WARNING: This appliance must be earthed.