

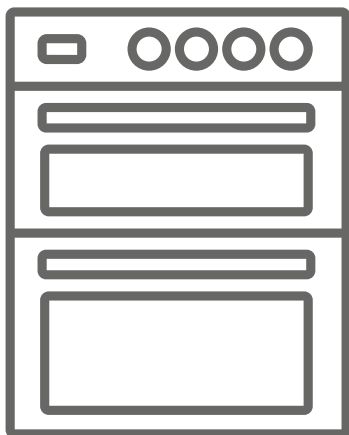

**EN** Double Oven / User Manual







**444444807 BEL FSG608DMc Sta**

**Thank you for choosing this product.**

This User Manual contains important safety information and instructions on the operation and maintenance of your appliance.

Please take the time to read this User Manual before using your appliance and keep this book for future reference.

| Icon   | Type                          | Meaning                        |
|--|-------------------------------|--------------------------------|
|  | <b>WARNING</b>                | Serious injury or death risk   |
|  | <b>RISK OF ELECTRIC SHOCK</b> | Dangerous voltage risk         |
|  | <b>FIRE</b>                   | Fire risk                      |
|  | <b>CAUTION</b>                | Injury or property damage risk |
|  | <b>IMPORTANT</b>              | Operating the system correctly |

# CONTENTS

|  |           |
|--|-----------|
| <b>1.SAFETY INSTRUCTIONS.....</b>                        | <b>4</b>  |
| 1.1 General Safety Warnings .....                        | 4         |
| 1.2 Installation Warnings .....                          | 7         |
| 1.3 During Use .....                                     | 8         |
| 1.4 During Cleaning and Maintenance .....                | 10        |
| <b>2.INSTALLATION AND PREPARATION FOR USE.....</b>       | <b>12</b> |
| 2.1 Instructions for the Installer .....                 | 12        |
| 2.2 Installation of the Cooker.....                      | 13        |
| 2.3 Gas Connection.....                                  | 13        |
| 2.4 Gas Conversion (If available) .....                  | 14        |
| 2.5 Electrical Connection and Safety (If available)..... | 16        |
| 2.6 Anti-tilting kit .....                               | 17        |
| 2.7 Adjusting the feet .....                             | 17        |
| <b>3.PRODUCT FEATURES.....</b>                           | <b>18</b> |
| <b>4.USE OF PRODUCT .....</b>                            | <b>19</b> |
| 4.1 Use of Gas Burners.....                              | 19        |
| 4.2 Hob Controls.....                                    | 19        |
| 4.3 Accessories .....                                    | 22        |
| <b>5.CLEANING AND MAINTENANCE.....</b>                   | <b>22</b> |
| 5.1 Cleaning.....  | 22        |
| 5.2 Maintenance .....                                    | 25        |
| 5.3 Maintenance .....                                    | 25        |
| <b>6.TROUBLESHOOTING &amp; TRANSPORT .....</b>           | <b>26</b> |
| 6.1 Troubleshooting.....                                 | 26        |
| 6.2 Transport.....                                       | 27        |
| <b>7.TECHNICAL SPECIFICATIONS.....</b>                   | <b>28</b> |
| 7.1 Injector Table .....                                 | 28        |
| 7.2 Energy Fiche .....                                   | 29        |
| 7.3 Energy Fiche .....                                   | 30        |



# 1. SAFETY INSTRUCTIONS



- Carefully read all instructions before using your appliance and keep them in a convenient place for reference when necessary.
- This manual has been prepared for more than one model therefore your appliance may not have some of the features described within. For this reason, it is important to pay particular attention to any figures whilst reading the operating manual.



## 1.1 General Safety Warnings

- This appliance can be used by children aged from 8 years and above and by persons with reduced physical, sensory or mental capabilities or lack of experience and knowledge if they have been given supervision or instruction concerning use of the appliance in a safe way and understand the hazards involved. Children should not play with the appliance. Cleaning and user maintenance should not be made by children without supervision.

 **WARNING:** The appliance and its accessible parts become hot during use. Care should be taken to avoid touching heating elements. Keep children less than 8 years of age away unless they are continually supervised.

  **WARNING:** Unattended cooking on a hob with fat or oil can be dangerous and may result in fire. NEVER try to extinguish such a fire with water, but switch off the appliance and cover the flame with a lid or a fire blanket.

  **WARNING:** Danger of fire: Do not store items on the cooking surfaces.

  **WARNING:** If the surface is cracked, switch off the appliance to avoid the possibility of electric shock.

- For models which incorporate a hob lid, clean any spillages off the lid before use and allow the cooker to cool before closing the lid.
- Do not operate the appliance with an external timer or separate remote-control system.

**! WARNING:** To prevent the appliance tipping, the stabilising brackets must be installed. (For detailed information refer to the anti-tilting kit set guide & section "Anti-tilting kit".)

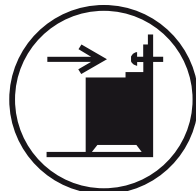

- During use the appliance will get hot. Care should be taken to avoid touching heating elements inside the oven.
- Handles may become hot after a short period during use.
- Do not use harsh abrasive cleaners or scourers to clean oven surfaces. They can scratch the surfaces which may result in shattering of the door glass or damage to surfaces.
- Do not use steam cleaners to clean the appliance.

**⚡ ! WARNING:** To avoid the possibility of electric shock, make sure that the appliance is switched off before replacing the lamp.

**! CAUTION:** Accessible parts may be hot when cooking or grilling. Keep young children away from the appliance when it is in use.

- Your appliance is produced in accordance with all applicable local and international standards and regulations.
- Maintenance and repair work should only be carried out by authorised service technicians. Installation and repair work that is carried out by unauthorised

technicians may be dangerous. Do not alter or modify the specifications of the appliance in any way. Inappropriate hob guards can cause accidents.

- Before connecting your appliance, make sure that the local distribution conditions (nature of the gas and gas pressure or electricity voltage and frequency) and the specifications of the appliance are compatible. The specifications for this appliance are stated on the rating label/data badge.

 **CAUTION:** This appliance is designed only for cooking food and is intended for indoor domestic household use only. It should not be used for any other purpose or in any other application, such as for non-domestic use, in a commercial environment or for heating a room.

- Do not use the oven door handles to lift or move the appliance.
- This appliance is not connected to a ventilation device. It should be installed and connected in accordance with current installation regulations. Particular attention shall be given to the relevant requirements regarding ventilation.
- If the burner has not lit after 15 seconds, stop operating the device and open the compartment door. Wait at least 1 minute before attempting to ignite the burner again.
- These instructions are only valid if the correct country symbol appears on the appliance. If the symbol does not appear on the appliance, refer to the technical instructions which describe how to modify the appliance to match the conditions of use of the country.
- All possible measures have been taken to ensure your safety. Since the glass may break, care should

be taken while cleaning to avoid scratching. Avoid hitting or knocking the glass with accessories.

- Make sure that the supply cord is not trapped or damaged during installation. If the supply cord is damaged, it must be replaced by the manufacturer, its service agent or similarly qualified persons in order to prevent a hazard.
- Do not let children climb on the oven door or sit on it while it is open.
- If your appliance is provided with a cooking hotplate made of glass or glass ceramic:
  - ⚠ **CAUTION:** “In case of hotplate glass breakage”:
    - immediately shut off all burners and any electrical heating element and isolate the appliance from the power supply
    - do not touch the appliance surface
    - do not use the appliance.
- Please keep children and animals away from this appliance.

⚠ **CAUTION:** The cooking process has to be supervised. A short term cooking process has to be supervised continuously.

## 1.2 Installation Warnings



- Do not operate the appliance before it is fully installed.
- The appliance must be installed by an authorised technician. The manufacturer is not responsible for any damage that might be caused by incorrect placement and installation by unauthorised people.
- When the appliance is unpacked, make sure that it is has not been damaged during transportation. In the case of a defect do not use the appliance and contact a qualified service agent immediately. The materials used for packaging (nylon, staples, styrofoam, etc.) may be harmful to children and they should be collected and removed immediately.

- Protect your appliance from the atmosphere. Do not expose it to sun, rain, snow, dust or excessive humidity.
- Materials around the appliance (i.e. cabinets) must be able to withstand a minimum temperature of 100°C.
- The Product must not be placed on a base, it must be placed on the floor.

 **CAUTION:** This appliance must not be installed behind a decorative door in order to avoid overheating.

### 1.3 During Use

- When you first use your oven you may notice a slight smell. This is perfectly normal and is caused by the insulation materials on the heater elements. We suggest that, before using your oven for the first time, you leave it empty and set it at maximum temperature for 45 minutes. Make sure that the environment in which the product is installed is well ventilated and all documentation has been removed from inside the oven.
- Take care when opening the oven door during or after cooking. The hot steam from the oven may cause burns.
- Do not put flammable or combustible materials in or near the appliance when it is operating.
- Always use oven gloves to remove and replace food in the oven.

  Do not leave the cooker unattended when cooking with solid or liquid oils. They may catch fire under extreme heating conditions. Never pour water on to flames that are caused by oil, instead switch the cooker off and cover the pan with its lid or a fire blanket.

- Always position pans over the centre of the cooking zone, and turn the handles to a safe position so they cannot be knocked.



- If the product will not be used for a long period of time, turn the main control switch off. Turn the gas valve off when gas appliances are not in use.
- Make sure the appliance control knobs are always in the “0” (stop) position when the appliance is not in use.
- The trays (presence depends on the product model) incline when pulled out. Take care not to spill or drop hot food when removing it from the oven.

**⚠ CAUTION:** The use of a gas cooking appliance results in the production of heat, moisture and products of combustion in the room in which it is installed. Ensure that the kitchen is well ventilated especially when the appliance is in use, keep natural ventilation holes open or install a mechanical ventilation device (mechanical extractor hood).

- Prolonged intensive use of the appliance may call for additional ventilation, such as opening a window, or for more effective ventilation, for example by increasing the level of mechanical ventilation where present.
- While using the grill burner, keep the oven door open and always use the grill deflector shield supplied with the product. Never use the grill burner with the oven door closed.

**⚠ CAUTION:** Glass lids may shatter when heated. Turn off all the burners and allow the hob surface to cool before closing the lid.



- Do not place anything on the oven door when it is open. This could unbalance the oven or damage the door.

- Do not place heavy or flammable items (e.g. nylon, plastic bags, paper, cloth, etc.) into the product. This includes cookware with plastic accessories (e.g. handles).

 **CAUTION:** The inside surface of the storage compartment may get hot when the appliance is in use. Avoid touching the inside surface.

- Do not hang towels, dishcloths or clothes from the appliance or its handles.

#### **1.4 During Cleaning and Maintenance**

- Make sure that your appliance is turned off at the mains before carrying out any cleaning or maintenance operations.
- Do not remove the control knobs to clean the control panel.
- To maintain the efficiency and safety of your appliance, we recommend you always use original spare parts and to call our authorised service agents when needed.

#### **CE Declaration of conformity**

 We declare that our products meet the applicable European Directives, Decisions and Regulations and the requirements listed in the standards referenced.

This appliance has been designed to be used only for home cooking. Any other use (such as heating a room) is improper and dangerous.

 The operating instructions apply to several models. You may notice differences between these instructions and your model.

## Disposal of your old machine



This symbol on the product or on its packaging indicates that this product should not be treated as household waste. Instead it should be handed over to the applicable collection point for the recycling of electrical and electronic equipment. By ensuring this product is disposed of correctly, you will help prevent potential negative consequences for the environment and human health, which could otherwise be caused by inappropriate waste handling of this product. For more detailed information about recycling of this product, please contact your local city office, your household waste disposal service or the retailer who you purchased this product from.

## 2. INSTALLATION AND PREPARATION FOR USE

**! WARNING :** This appliance must be installed by an authorised service person or qualified technician, according to the instructions in this guide and in compliance with the current local regulations.

- Incorrect installation may cause harm and damage, for which the manufacturer accepts no responsibility and the warranty will not be valid.
- Prior to installation, ensure that the local distribution conditions (electricity voltage and frequency and/or nature of the gas and gas pressure) and the adjustments of the appliance are compatible. The adjustment conditions for this appliance are stated on the rating label/data badge.
- The laws, ordinances, directives and standards in force in the country of use are to be followed (safety regulations, proper recycling in accordance with the regulations, etc.).

### 2.1 Instructions for the Installer

#### Ventilation requirements

- For rooms with a volume of less than 5 m<sup>3</sup>, permanent ventilation of 100 cm<sup>2</sup> free area is required.
- For rooms with a volume of between 5 m<sup>3</sup> and 10 m<sup>3</sup>, permanent ventilation of 50 cm<sup>2</sup> free area will be required, unless the room has a door which opens directly to outside air in which case no permanent ventilation is required.
- For rooms with a volume greater than 10 m<sup>3</sup>, no permanent ventilation is required.

**! Important:** Regardless of room size, all rooms containing the appliance must have direct access to outside air via an openable window or equivalent.

#### Emptying of burned gases from the environment

Gas appliances expel burned gas waste to the outside air, either directly or via a cooker hood with a chimney. If it is not possible to install a cooker hood, install a fan on the window or wall that has access to fresh air. The fan must have the capacity to change the volume of air in the kitchen a minimum of 4-5 times per hour.

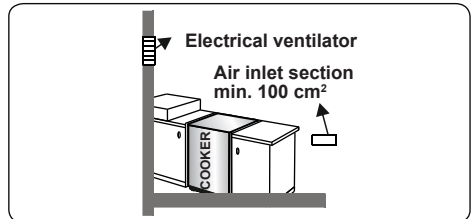
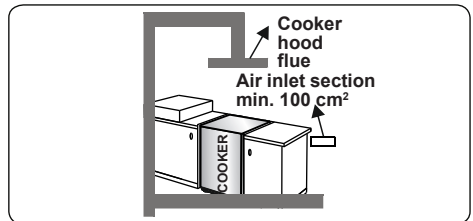
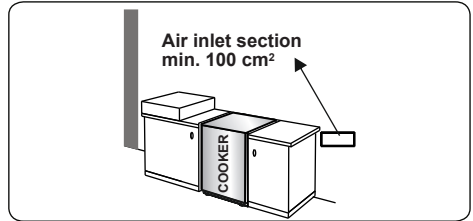
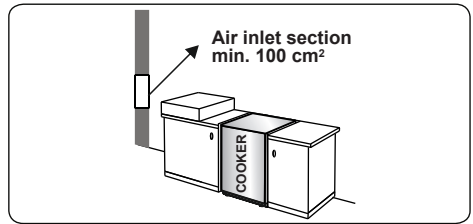

#### General instructions

- After removing the packaging material from the appliance and its accessories, ensure that the appliance is not damaged. If you suspect any damage, do not use it and contact an authorised service person or qualified technician immediately.
- Make sure that there are no flammable or combustible materials in the close vicinity, such as curtains, oil, cloth etc. which may catch fire.
- The worktop and furniture surrounding the appliance must be made of materials resistant to temperatures above 100°C.

- The appliance should not be installed next to a dishwasher, fridge, freezer, washing machine or clothes dryer.
- The appliance can be placed close to other furniture on condition that, in the area where the appliance is set up, the furniture's height does not exceed the height of the cooktop.

## 2.2 Installation of the Cooker

- If the kitchen furniture is higher than the cooktop, the kitchen furniture must be at least 10 cm away from the sides of appliance for air circulation.

- There should be a minimum 2cm blank space around the appliance for air circulation.
- If a cooker hood or cupboard is to be installed above the appliance, the safety distance between cooktop and any cupboard/cooker hood should be as shown below.

|                                    |               |
|------------------------------------|---------------|
| <b>A (mm)</b>                      | 420           |
| <b>B (mm) Cooker Hood/Cupboard</b> | 650/700       |
| <b>C (mm) Spacing</b>              | 20            |
| <b>D (mm)</b>                      | Product Width |
| <b>E (mm)</b>                      | 100           |

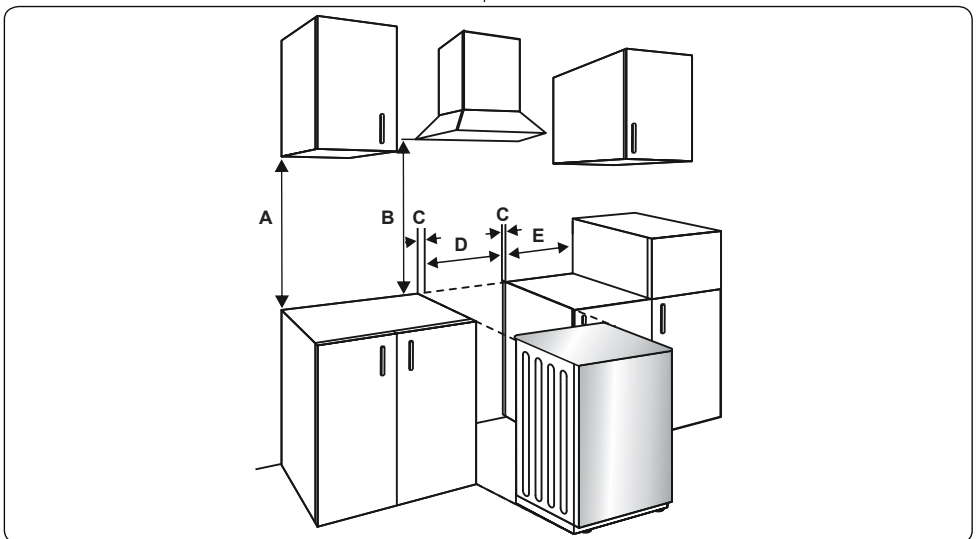

## 2.3 Gas Connection

### Assembly of gas supply and leakage check

Connect the appliance in accordance with applicable local and international standards and regulations. First, check what type of gas is installed on the cooker. This information is available on a sticker on the back of the cooker. You can find the information related to appropriate gas types and appropriate gas injectors in the technical data table. Check that the feeding gas pressure matches the values on the technical data table, to be able to get the most efficient use and to ensure the minimum gas consumption. If the pressure of used gas is different than the values

stated or is not stable in your area, it may be necessary to assemble an available pressure regulator on the gas inlet. You should contact an authorised service centre to make these adjustments.

### Points that must be checked during flexible hose assembly

- If the gas connection is made by a flexible hose fixed onto the gas inlet of the hob, it must be fixed on by a pipe collar.
- Connect your appliance with a short and durable hose that is as close as possible to the gas source.
- The permitted maximum length of the hose is 1.5 m.

- The hose that supplies the appliance with gas should be checked once a year for your safety.
- The hose must be kept clear of areas that may heat up to temperatures of more than 90°C.
- The hose must not be cracked, torn, bent or folded.
- Keep the hose clear of sharp corners and objects that could move.
- Before you assemble the connection, you must make sure the hose is not damaged. Use bubbly water or leakage fluids to perform the check. Do not use a naked flame to check for gas leakage.
- All metal items that are used during gas connection must be free from rust. Check the expiry date of any components used for connection.

### Points that must be checked during fixed gas connection assembly

The method used to assemble a fixed gas connection (gas connection made by threads, e.g. a nut) varies according to the country you are in. The most common parts for your country will be supplied with your appliance. Any other parts required can be supplied as spare parts.

During connection, always keep the nut on the gas manifold fixed while rotating the counter-part. Use appropriately-sized spanners for a safe connection. For surfaces between different components always use the seals provided in the gas conversion kit.

The seals used during connection should also be approved to be used in gas connections. Do not use plumbing seals for gas connections.

Remember that this appliance is ready to be connected to the gas supply in the country for which it has been produced. The main country of destination is marked on the rear cover of the appliance. If you need to use it in another country, any of the connections in the figure below may be required. In such a case, contact local authorities to learn the correct gas connection.

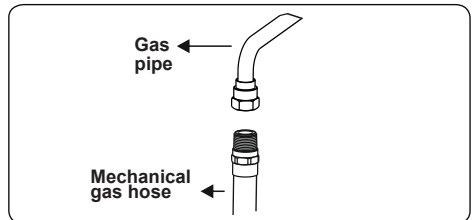
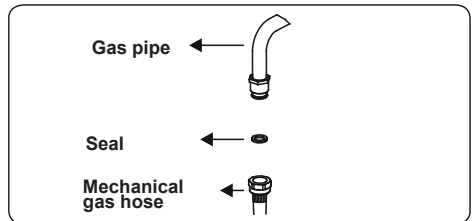
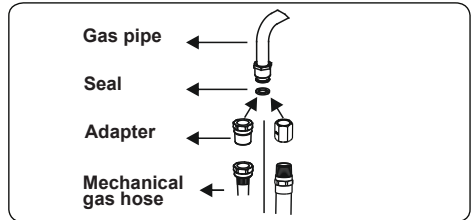
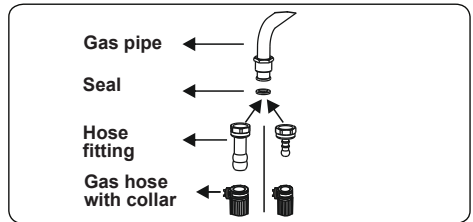

The Cooker must be installed and maintained by a suitably qualified gas registered technician in accordance with current safety legislation.

**⚠ WARNING:** Do not use a naked flame to check for gas leaks. Use leak detection fluids

### 2.4 Gas Conversion (If available)

Your product may include a gas conversion kit which can be used to convert between NG or LPG types of gas. Please refer to the rating label to confirm if your appliance is convertible to LPG or NG. The gas burners can be adapted to different types of gas, by replacing the corresponding injectors and adjusting the minimum flame length suitable to the gas in use. For this purpose, the following steps should be performed:

## Changing injectors Hob burners

- Cut off the main gas supply and unplug the appliance from the mains electrical supply.
- Remove the burner caps and the adapters.
- Use a 7 mm spanner to unscrew the injectors.
- Replace the injector with the ones from the gas conversion kit, with the correct diameters for the type of gas that is going to be used, according to the gas injector table.

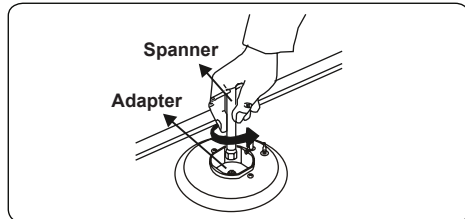
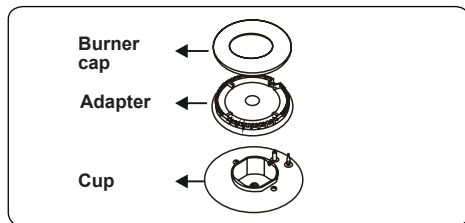

## Oven Injector

The oven burner is held in its cradle by a single clip on the left-hand side of the burner. Pull the clip towards the left and, with your other hand, lift the burner up holding from the thermocouple/spark plug holder. The injector is on the right-hand side of the burner cradle. Repeat the same procedure for both the Main and Top Oven (if present) burners.

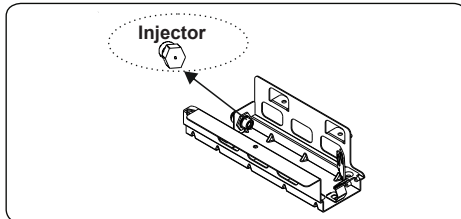
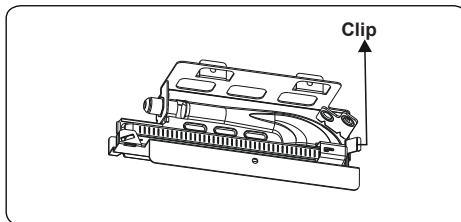

Remove the injectors using a 7mm spanner and replace the injector with the ones from the spare set. Make sure you use corresponding diameters suitable to the type of gas that is going to be used, according to the information chart (which is also supplied in the gas conversion kit).

## Adjusting the minimum flame position

First of all, make sure that the appliance is unplugged from the mains electrical supply and that the gas feed is open. The minimum flame position is adjusted with a flat screw located on the valve. As shown in the figures; for valves with a flame failure safety device, the screw is located on the side of the valve spindle and for valves without a flame failure safety device, the screw is located inside the valve spindle. To make adjusting the flame position easier, we recommend that you remove the control panel (and the micro switch if your model has one) during the alteration. The bypass screw must be loosened for conversion from LPG to natural gas. For conversion from natural gas to LPG, the bypass screw must be tightened.

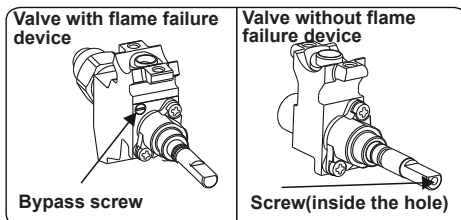

**Determining the minimum flame position**

To determine the minimum position, ignite the burners and leave them on in the minimum position. Remove the knobs to gain access to the screws. With the help of a small screwdriver, fasten or loosen the bypass screw by around 90 degrees. When the flame has a length of at least 4mm, the gas is well distributed. Make sure that the flame does not die out when passing from the maximum position to the minimum position. Create an artificial wind with your hand towards the flame to see if the flames are stable. For the oven burner, operate the oven burner at the minimum position for 5 minutes, then open and close the oven door 2-3 times to check the flame stability of the burner.

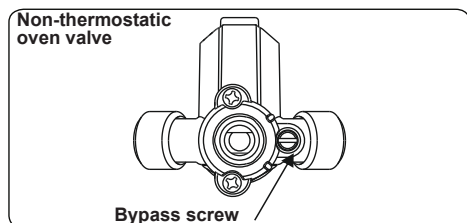
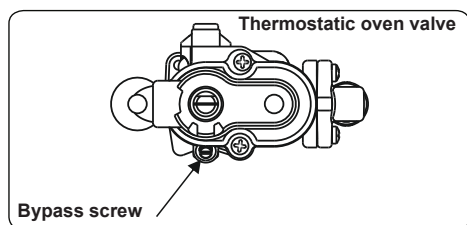

### Changing the gas inlet

For some countries, the gas inlet type can be different for NG/LPG gases. In this case, remove the current connection components and nuts (if any) and connect the new gas supply accordingly. In all conditions, all components used in gas connections should be approved by local and/or international authorities. In all gas connections, refer to the "Assembly of gas supply and leakage check" clause explained above.

### 2.5 Electrical Connection and Safety (If available)

**WARNING:** The electrical connection of this appliance should be carried out by an authorised service person or qualified electrician, according to the instructions in this guide and in compliance with the current local regulations.

**WARNING: THE APPLIANCE MUST**

### BE EARTHED.

- Before connecting the appliance to the power supply, the voltage rating of the appliance (stamped on the appliance identification plate) must be checked for correspondence to the available mains supply voltage, and the mains electric wiring should be capable of handling the appliance's power rating (also indicated on the identification plate).
- During installation, please ensure that isolated cables are used. An incorrect connection could damage your appliance. If the mains cable is damaged and needs to be replaced this should be done by a qualified person.
- Do not use adaptors, multiple sockets and/or extension leads.
- The supply cord should be kept away from hot parts of the appliance and must not be bent or compressed. Otherwise the cord may be damaged, causing a short circuit.
- If the appliance is not connected to the mains with a plug, a all-pole disconnector (with at least 3 mm contact spacing) must be used in order to meet the safety regulations.
- The appliance is designed for a power supply of 220-240 V~. If your supply is different, contact the authorized service personnel or qualified electrician.
- The power cable must be long enough to be connected to the appliance.
- The fused switch must be easily accessible once the appliance has been installed.
- Ensure all connections are adequately tightened.
- Fix the supply cable in the cable clamp and then close the cover.
- The terminal box connection is placed on the terminal box.



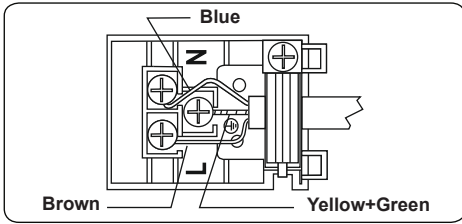

| Product Dimensions<br>(Width X Depth X Height) (Cm) | A (mm) | B (mm) |
|---|--------|--------|
| 60x60x90 (Double Oven)                              | 297.5  | 52     |
| 50x60x90 (Double Oven)                              | 247.5  | 52     |
| 90x60x85  | 430    | 107    |
| 60x60x90  | 309.5  | 112    |
| 60x60x85  | 309.5  | 64     |
| 50x60x90  | 247.5  | 112    |
| 50x60x85  | 247.5  | 64     |
| 50x50x90  | 247.5  | 112    |
| 50x50x85  | 247.5  | 64     |

## 2.6 Anti-tilting kit

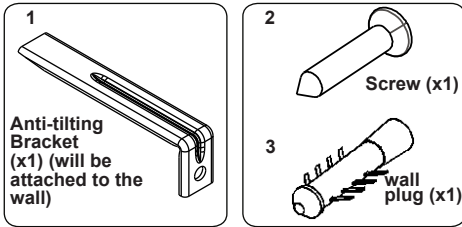

The document bag contains an anti-tilting kit. Loosely attach the anti-tilting bracket (1) to the wall using the screw (2) and wall plug (3), following the measurements shown in the figure and table below. Adjust the height of the anti-tilting bracket so that it lines up with the slot on the cooker and tighten the screw. Push the appliance towards the wall making sure that the anti-tilting bracket is inserted into the slot on the rear of the appliance.

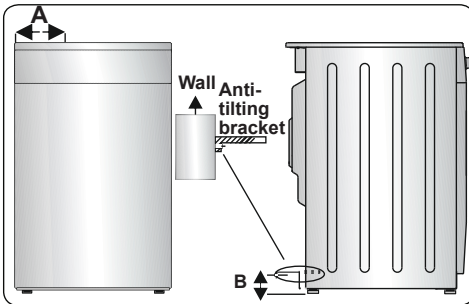

## 2.7 Adjusting the feet

Your product stands on four adjustable feet. For safe operation, it is important that your appliance is correctly balanced. Make sure the appliance is level prior to cooking. To increase the height of the appliance, turn the feet anti-clockwise. To decrease the height of the appliance, turn the feet clockwise.

It is possible to raise the height of the appliance up to 30 mm by adjusting the feet. The appliance is heavy and we recommend that a minimum of 2 people lift it. Never drag the appliance.

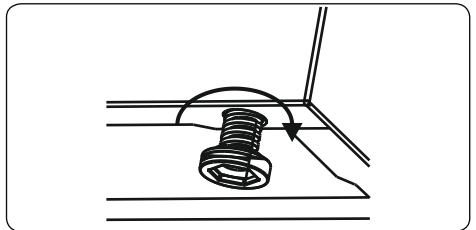

### 3. PRODUCT FEATURES



**Important:** Specifications for the product vary and the appearance of your appliance may differ from that shown in the figures below.

#### List of Components

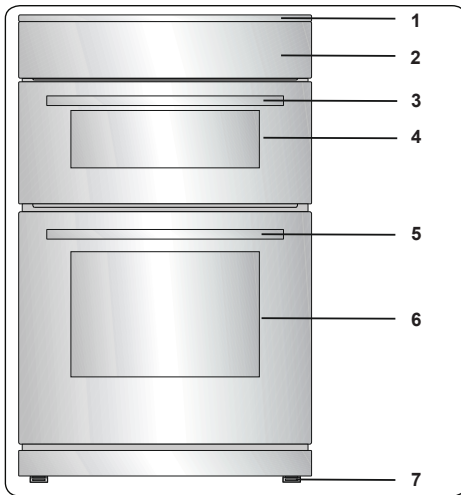

1. Cooktop
2. Control Panel
3. Top Oven Door Handle
4. Top Oven Door
5. Main Oven Door Handle
6. Main Oven Door
7. Adjustable Feet

#### Control Panel

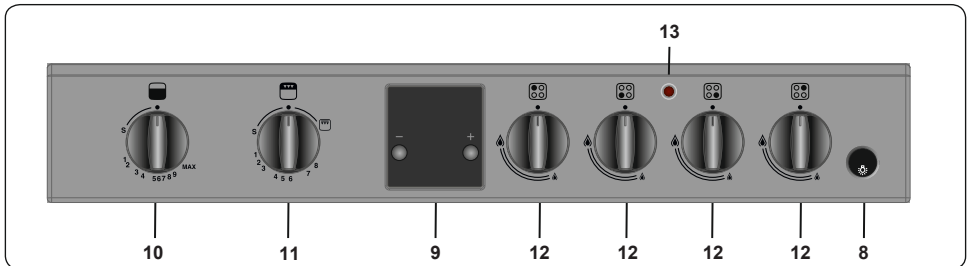

8. Button (Ignition/Oven Lamp)
9. Timer
10. Main Oven Control Knob
11. Top Oven Control Knob
12. Hob Control Knob
13. Warning Light

## 4. USE OF PRODUCT

### 4.1 Use of Gas Burners

#### Ignition of the Burners

The position symbol above each control knob indicates the burner that the knob controls.

#### Manual ignition of the gas burners

If your appliance is not equipped with an ignition aid, or in case there is a failure in the electric network, follow the procedures listed below.

**For hob burners:** Push in the knob of the burner you wish to ignite and keep it pressed while turning it anti-clockwise until the knob is in the 'maximum' position. Continue pressing the knob and hold a lit match, taper or other manual aid to the upper circumference of the burner. Move the ignition source away from the burner as soon as you see a stable flame.

**For oven burner:** Push in and turn the oven control knob anti-clockwise until the knob is in the 'maximum' position. Hold a lit match, taper or other manual aid to the ignition hole that is located on the front left corner of the burner. Move the ignition source away as soon as you see a stable flame.

**For grill burner:** Push in and turn the grill control knob clockwise until the marker on the knob points at the grill sign. Continue pressing the knob and hold a lit match, taper or other manual aid to the holes on the burner. Move the ignition source away from the burner as soon as you see a stable flame.

#### Electrical ignition by control knob

Push in the knob of the burner you wish to ignite and keep it pressed while turning it anti-clockwise until the knob is in the 90 degrees position. The microswitch under the spark plug will create sparks through the spark plug for as long as the control knob is pressed. Press the knob until you see a stable flame on the burner. After you see a stable flame continue pressing the knob just a few more seconds.

#### Flame safety device

##### Hob burners

Hobs equipped with a flame failure device provide security in case of an accidentally extinguished flame. If such a case occurs, the device will block the burners gas lines and will avoid any accumulation of unburned gas. Wait 90 seconds before re-igniting an extinguished gas burner.

#### Oven / Grill (If available) Burners

Regardless of the model of your appliance, all oven burners are equipped with a gas safety device. For this reason, during ignition, keep the oven knob pressed until you see stable flames. If the flames are cut out after you release the knob, repeat the ignition procedure. If the oven burner does not ignite after you keep the burner knob pressed for 30 seconds, open the oven door and do not attempt re-ignition for at least 90 seconds. If the oven flames go out accidentally, repeat the same procedure.

### 4.2 Hob Controls

#### Hob burner

The knob has 3 positions: off (0), maximum (big flame symbol) and minimum (small flame symbol). Ignite the burner with the knob in the 'maximum' position; you can then adjust the flame length between the 'maximum' and 'minimum' positions. Do not operate the burners when the knob is between the 'maximum' and 'off' positions.

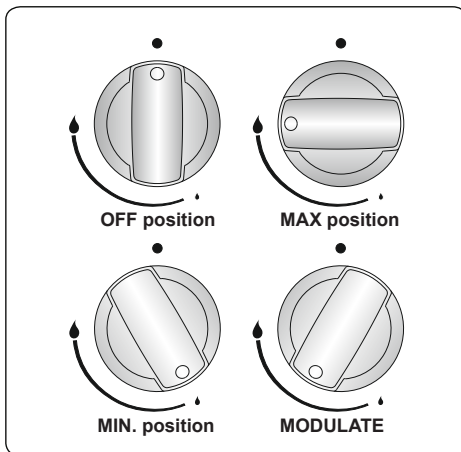

After ignition, visually check the flames. If you see a yellow tip, lifted or unstable flame, switch the gas flow off, then check the assembly of burner caps and crowns once they have cooled. Make sure there is no liquid in the burner caps. If the burner flames go out accidentally, switch the burners off, ventilate the kitchen with fresh air and wait at least 90 seconds before attempting re-ignition.

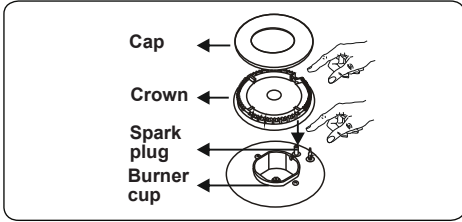

To switch the hob burners off, turn the hob burner knob clockwise to the '0' position or so that the marker on the hob burner knob points upwards.

Your hob has burners of different diameters. You will find that the most economical way of using gas is to choose the correct size gas burner for your cooking pan size and to bring the flame to the 'minimum' position once boiling point is reached. We recommend that you always cover your cooking pan to avoid heat loss.

To obtain maximum performance from the main burners, we suggest you use pots with the following flat bottom diameters. Using pots smaller than the minimum dimensions shown below will cause energy loss.

|                    |          |
|--------------------|----------|
| Rapid / Wok Burner | 22-26 cm |
| Semi-rapid Burner  | 14-22 cm |
| Auxiliary Burner   | 12-18 cm |

Make sure that the tips of the flames do not spread out from the outer circumference of the pan, as this may harm plastic accessories, such as handles.

Switch the main gas control valve off when the burners are not in use for prolonged periods of time.

**! WARNING:**

- Only use flat-bottomed pans with thick bases.
- Make sure the bottom of the pan is dry before placing it on the burner.
- The temperature of accessible parts may become high while the appliance is operating. It is imperative that children and animals are kept well away from the burners during and after cooking.
- After use, the hob remains very hot for a prolonged period of time. Do not touch it and do not place any object on top of it.
- Never place knives, forks, spoons and lids on the hob as they will get hot and

could cause serious burns.

- Do not allow pan handles or any other cooking utensils to project over the edge of the cooker top.

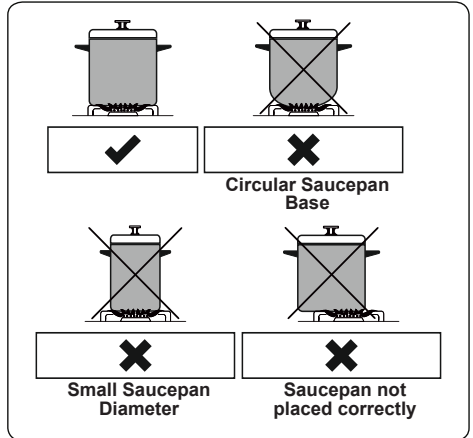

**Main Oven Controls**

**Main Oven Burner Controls**

After you ignite the oven burner, you can adjust the temperature inside the oven, as required, using the numbers on the control panel or knob. The higher numbers provide higher temperatures, while the smaller numbers provide lower temperatures.

| Function Description |   |
|----------------------|---|
| S 1...9 Max.         | Turn the control anti-clockwise to set to the Gas Mark as required. |

Do not operate the appliance between the "Off" position and the first temperature marker in the anti-clockwise direction. Always use the oven between the maximum and minimum settings. When switching the oven off, turn the knob in the clockwise direction to the "0" position.

**Preheating**

We recommend you preheat the oven for 10 minutes before use. For recipes needing high temperatures, such as bread, pastries, scones or soufflés, best results are achieved if the oven is preheated first. For best results when cooking from frozen or cooking chilled ready meals, always preheat the oven first.

| Position | Temperature(°C) |
|----------|-----------------|
| MAX      | 270             |
| 9        | 240             |
| 8        | 230             |
| 7        | 220             |
| 6        | 210             |
| 5        | 200             |
| 4        | 180             |
| 3        | 170             |
| 2        | 150             |
| 1        | 140             |
| S        | 120             |

### Cooking

- Ensure that food is placed centrally on the shelf and that there is sufficient room around the baking tray / dish to allow for maximum circulation.
- Stand dishes on a suitably sized baking tray on the shelf to prevent spillage onto the oven base and to help reduce the amount of cleaning required.
- The material and finish of the baking tray and dishes used will affect base browning. Enamel, dark, heavy or nonstick utensils increase base browning. Shiny aluminium or polished steel trays reflect the heat away and reduce base browning.
- When cooking more than one dish in the oven, place dishes centrally on different shelves rather than cluster several dishes on one shelf. This will allow the heat to circulate freely for the best cooking results.
- If you are cooking more than one tray of similar items, for example cakes or biscuits, swap the trays during cooking or remove the top tray when the food on it is cooked and move the lower tray to the higher shelf to finish cooking.
- Do not place baking trays directly on the oven base as it interferes with the oven air circulation and can lead to base burning. Use the lower shelf position.

### Oven Lamp(For main oven and top oven)



There is an oven lamp inside the oven to illuminate the cooking area. Press the lamp

button to switch the lamp on or off.

### Top Oven Controls

#### Top Oven Burner Controls

After you ignite the oven burner, you can adjust the temperature inside the oven, as required, using the numbers on the control panel or knob. The higher numbers provide higher temperatures, while the smaller numbers provide lower temperatures.

| Function Description |   |
|----------------------|---|
| S 1...8              | Turn the control anti-clockwise to set to the Gas Mark as required. |

Do not operate the appliance between the “Off” position and the first temperature marker in the anti-clockwise direction. Always use the oven between the maximum and minimum settings. When switching the oven off, turn the knob in the clockwise direction to the “0” position.

#### Preheating

We recommend you preheat the oven for 10 minutes before use. For recipes needing high temperatures, such as bread, pastries, scones or soufflés, best results are achieved if the oven is preheated first. For best results when cooking from frozen or cooking chilled ready meals, always preheat the oven first.

| Position | Temperature(°C) |
|----------|-----------------|
| 8        | 230             |
| 7        | 220             |
| 6        | 200             |
| 5        | 190             |
| 4        | 180             |
| 3        | 170             |
| 2        | 150             |
| 1        | 140             |
| S        | 120             |

### Cooking

- Ensure that food is placed centrally on the shelf and that there is sufficient room around the baking tray / dish to allow for maximum circulation.
- Stand dishes on a suitably sized baking tray on the shelf to prevent spillage onto the oven base and to help reduce the amount of cleaning required.
- The material and finish of the baking tray and dishes used will affect base browning. Enamel, dark, heavy or

nonstick utensils increase base browning. Shiny aluminium or polished steel trays reflect the heat away and reduce base browning.

- When cooking more than one dish in the oven, place dishes centrally on different shelves rather than cluster several dishes on one shelf. This will allow the heat to circulate freely for the best cooking results.
- If you are cooking more than one tray of similar items, for example cakes or biscuits, swap the trays during cooking or remove the top tray when the food on it is cooked and move the lower tray to the higher shelf to finish cooking.
- Do not place baking trays directly on the oven base as it interferes with the oven air circulation and can lead to base burning. Use the lower shelf position.

### Top Oven Grill Burner Controls

\* The functions available on your oven may differ from those listed below depending on the model purchased.



#### Faster Grilling

**Function:** Switch on the FASTER GRILL function using the function selector knob. The oven thermostat and warning lights will

illuminate, and the grill and upper heating elements will switch on. The temperature setting will set to the highest level when this function is selected. Use this function for wide area grilling. When you have finished grilling, switch the top oven off. Keep children away from the oven during grilling and until the oven has fully cooled after use.



**Warning:** The top oven door must be kept fully open during use of this function

### Use of the Digital Minute Minder Timer- Time adjustment

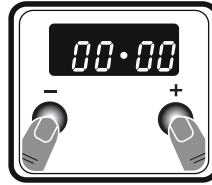

1. Press the “+” and “-” keys simultaneously. The screen will start to flash.

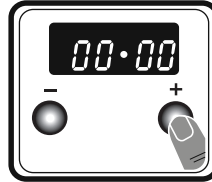

2. Adjust the time while the dot is flashing using the “+” and “-” keys.

### Audible warning time adjustment

The audible warning time can be set to any time between **0:00** and **23:59** hours. The audible warning time is for warning purposes only. The oven will not be activated with this function.

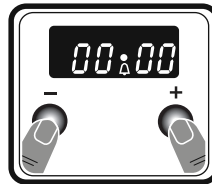

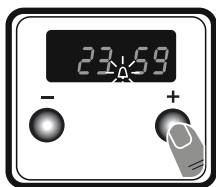

1. Press the “+” and “-” keys. The symbol  will begin to flash and “000” will be displayed.

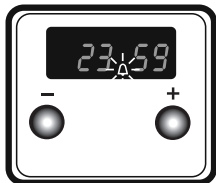

2. Select the desired time period using the “+” and “-” keys while  is flashing.



3. The symbol  will remain illuminated, the time will be saved and the warning will be set.

When the timer reaches the end time, an audible warning will sound and the symbol  will flash on the display. Press any key to stop the audible warning and the  symbol will disappear. The symbol will disappear but the oven will continue to operate. Use the switch and oven controls to switch the oven off.

### Sound Adjustment

To adjust the volume of the audible warning sound, while the current time of day is displayed, press and hold the “-” button for 1-2 seconds until an audible signal sounds. After this, each time the “-” button is pressed, a different signal will sound. There are three different types of signal sounds. Select the desired sound and do not press any other buttons. After a short time, the selected sound will be saved.

## 4.3 Accessories

### The Grill Pan and Handle Set

The grill pan set is best used for grilling steaks and similar foods.

 **WARNING:** The grill pan has a detachable handle. Make sure when using the grill pan handle that it is centralised and secure, as shown in the figure. Do not leave the handle in position while grilling is in operation.

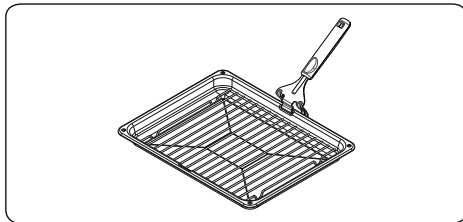

### The Wire Grid

The wire grid is best used for grilling or for processing food in oven-friendly containers.

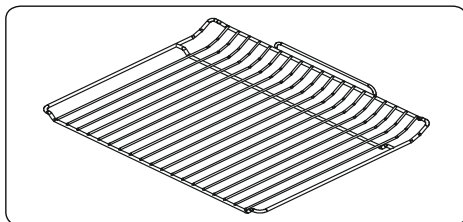

### WARNING

Place the grid to any corresponding rack in the oven cavity correctly and push it to the end.

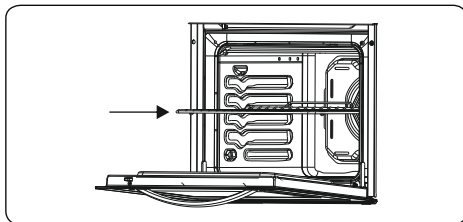

### The Gas Shut-Off Valve

For your safety, the glass hob lid is equipped with a safety valve that will cut off the gas feed to the hob burners if the lid is lowered. The oven and grill burners will continue to operate regardless of the position of the hob lid.

 **Important:** This function must not be used for controlling the burners.

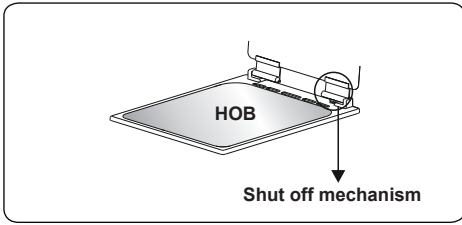

## 5. CLEANING AND MAINTENANCE

### 5.1 Cleaning

**WARNING:** Switch off the appliance and allow it to cool before cleaning is to be carried out.

#### General Instructions

- Check whether the cleaning materials are appropriate and recommended by the manufacturer before use on your appliance.
- Use cream cleaners or liquid cleaners which do not contain particles. Do not use caustic (corrosive) creams, abrasive cleaning powders, rough wire wool or hard tools as they may damage the cooker surfaces.



Do not use cleaners that contain particles, as they may scratch the glass, enamelled and/or painted parts of your appliance.

- Should any liquids overflow, clean them immediately to avoid parts becoming damaged.



Do not use steam cleaners for cleaning any part of the appliance.

#### Cleaning the Inside of the Oven

- The inside of enamelled ovens are best cleaned while the oven is warm.
- Wipe the oven with a soft cloth soaked in soapy water after each use. Then, wipe the oven over again with a wet cloth and dry it.
- You may need to use a liquid cleaning material occasionally to completely clean the oven.

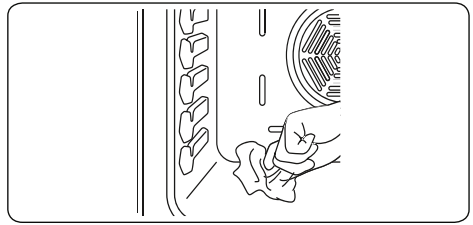

#### Catalytic Cleaning

Catalytic liners are installed within the oven cavity. These are the matte-finished, light-coloured panels on the sides and/or the matte-finished panel at the rear of the oven. They work by collecting any grease and oil residue during cooking.

The liner self-cleans by absorbing fats and oils. The lining must be porous to be effective. The liner may discolour with age.

If a large amount of fat is spilled onto the liner, it may reduce its efficiency. To overcome this problem, set the oven to maximum temperature for about 20 - 30 minutes. After the oven has cooled, wipe out the floor of the oven.

Manual cleaning of the catalytic liners is not recommended. Damage will occur if a soap-impregnated steel wool pad or any other abrasives are used. In addition, we do not recommend the use of aerosol cleaners on the liners. The walls of a catalytic liner may become ineffective due to excess grease. The excess grease can be removed with a soft cloth or sponge soaked in hot water and the cleaning cycle can be carried out as described above.

#### Removal of the Catalytic Liner

To remove the catalytic liner, remove the screws holding each catalytic panel to the oven.

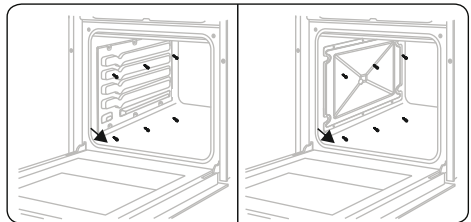



## Cleaning the Gas Hob

- Clean the gas hob on a regular basis.
- Take off the pan supports, caps and crowns of the hob burners.
- Wipe the hob surface with a soft cloth soaked in soapy water. Then, wipe the hob surface over again with a wet cloth and dry it.
- Wash and rinse the hob-burner caps. Do not leave them wet. Dry them immediately with a dry cloth.
- Make sure you re-assemble all parts correctly after cleaning.
- The surfaces of the pan supports may become scratched over time due to the use. This is not a production fault.

 Do not use a metal sponge for cleaning any part of the hob.

 Make sure no water gets into the burners as this may block the injectors.

## Cleaning the Glass Parts

- Clean the glass parts of your appliance on a regular basis.
- Use a glass cleaner to clean the inside and outside of the glass parts. Then, rinse and dry them thoroughly with a dry cloth.

## Cleaning the Enamelled Parts

- Clean the enamelled parts of your appliance on a regular basis.
- Wipe the enamelled parts with a soft cloth soaked in soapy water. Then, wipe them over again with a wet cloth and dry them.

 Do not clean the enamelled parts while they are still hot from cooking.

 Do not leave vinegar, coffee, milk, salt, water, lemon or tomato juice on the enamel for a long time.

## Cleaning the Stainless Steel Parts (if available)

- Clean the stainless steel parts of your appliance on a regular basis.
- Wipe the stainless steel parts with a soft cloth soaked in only water. Then, dry them thoroughly with a dry cloth.

 Do not clean the stainless steel parts while they are still hot from cooking.

 Do not leave vinegar, coffee, milk, salt, water, lemon or tomato juice on the stainless steel for a long time.

## Removal of the Inner Glass

You must remove the oven door glass before cleaning, as shown below.

1. Push the glass in the direction of **B** and release from the location bracket (**x**). Pull the glass out in the direction of **A**.

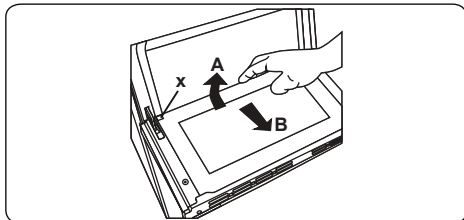

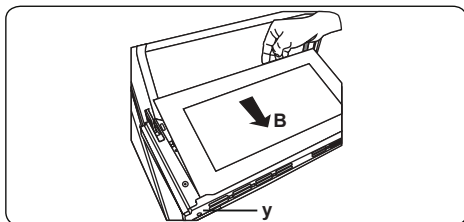

To replace the inner glass:

1. Push the glass towards and under the location bracket (**y**), in the direction of **B**.

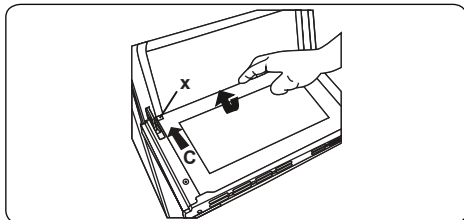

3. Place the glass under the location bracket (**x**) in the direction of **C**.



 If the oven door is a triple glass oven door, the third glass layer can be removed the same way as the second glass layer.

## Removal of the Oven Door

Before cleaning the oven door glass, you must remove the oven door, as shown below.

1. Open the oven door.

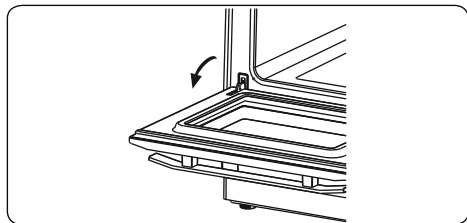

2. Open the locking catch (a) (with the aid of a screwdriver) up to the end position.

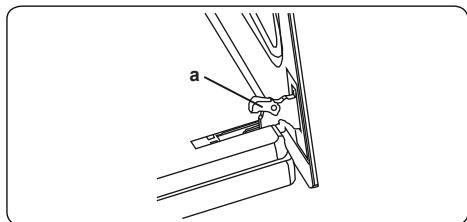

3. Close the door until it almost reaches the fully closed position and remove the door by pulling it towards you.

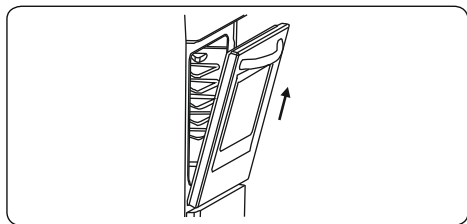

In order to replace the oven door on the appliance reverse the above procedure.

- Slide the hinge parts at the bottom of the door into their slots on the appliance holding the door in an almost closed position.
- Open the door slowly and close the locking catches.
- Close and open the door to be sure that it is correctly and securely in place.

## Removal of the Wire Shelf

To remove the wire rack, pull the wire rack as shown in the figure. After releasing it from the clips (a), lift it up.

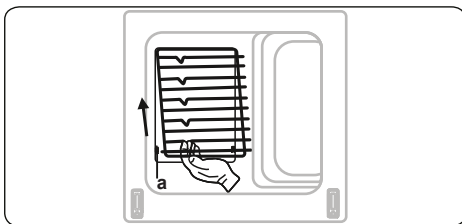

## 5.2 Maintenance

**WARNING:** The maintenance of this appliance should be carried out by an authorised service person or qualified technician only.

### Changing the Oven Lamp

**WARNING:** Switch off the appliance and allow it to cool before changing the lamp bulb.

- Remove the glass lens, then remove the bulb.
- Insert the new bulb (resistant to 300 °C) to replace the bulb that you removed (230 V, 15-25 Watt, Type E14).
- Replace the glass lens, and your oven is ready for use.



The lamp is designed specifically for use in household cooking appliances. It is not suitable for household room illumination.

### Other Controls

- Periodically check the gas connection pipe. If a defect is found, inform the technical service to have it changed.
- We recommend the gas connection components are changed annually. If a defect is found while operating the control knobs of the appliance, contact an authorised service provider.

### 5.3 Maintenance

 **WARNING:** The maintenance of this appliance should be carried out by an authorised service person or qualified technician only.

#### Other Controls

- Periodically check the gas connection pipe. If a defect is found, contact an authorised service provider to have it changed.
- We recommend the gas connection components are changed annually. If a defect is found while operating the control knobs of the appliance, contact an authorised service provider.

## 6. TROUBLESHOOTING & TRANSPORT

### 6.1 Troubleshooting



If you still have a problem with your appliance after checking these basic troubleshooting steps, please contact an authorised service person or qualified technician.

| Problem  | Possible Cause  | Solution  |
|--|---|---|
| Oven and/or grill (if available) do not work.      | <p>The oven and/or grill may be in the 'off' position.</p> <p>Supply gas pressure may not be correct.</p> <p>Power (if the appliance has an electric connection) is turned off.</p> <p>The feet have not been assembled.</p> <p>The battery (if the appliance equipped with battery) may be depleted.</p> | <p>Check the position of the control knob.</p> <p>Check the gas supply and gas pressure.</p> <p>Check whether there is power supplied. Also check that other kitchen appliances are working.</p> <p>Make sure that there is no block at the bottom of the appliance.</p> <p>The battery may need replacing.</p>                         |
| Oven is not cooking evenly.                        | <p>Wrong shelf position being used.</p> <p>Your appliance has been installed by an unauthorised technician.</p> <p>Fan (if applicable) may be in the 'off' position.</p>  | <p>Check the shelf positions, cooking period and heat values according to the manual.</p> <p>Check that the appliance is correctly installed.</p> <p>Ensure that the fan is working.</p>  |
| Oven temperature is too high or too low.           | <p>Wrong shelf position or wrong heat setting being used.</p> <p>Supply gas pressure may not be correct.</p>  | <p>Check that the optimum temperatures and shelf positions are being used. Be prepared to adjust the temperature up or down slightly to achieve the results you want.</p> <p>Check the gas supply and gas pressure.</p>   |
| Hob burners do not light.                          | <p>Burner cap and crown are not assembled correctly.</p> <p>Supply gas pressure may not be correct.</p> <p>LPG cylinder (if applicable) may be depleted.</p> <p>Power (if the appliance has an electric connection) is switched off.</p> <p>The battery (if applicable) may be depleted.</p>              | <p>Ensure the burner parts have been placed correctly.</p> <p>Check the gas supply and gas pressure.</p> <p>LPG cylinder may need replacing.</p> <p>Check whether there is power supplied. Also check that other kitchen appliances are working.</p> <p>The battery may need replacing.</p>   |
| Flame colour is orange/yellow.                     | <p>Burner cap and crown are not assembled correctly.</p> <p>Different gas compositions.</p>   | <p>Ensure the burner parts have been placed correctly.</p> <p>Due to the design of the burner, the flame can appear to be orange/yellow in certain areas of the burner.</p> <p>If you operate the appliance with natural gas, city natural gas may have different compositions. Do not operate the appliance for a couple of hours.</p> |
| Burner is not igniting or only partially lighting. | Burner parts may not be clean or dry.   | Ensure that parts of the appliance are dry and clean.   |
| Burner sounds noisy.                               | -   | This is normal. The noise may reduce as they heat up.   |
| Noise  | -   | It is normal for some metal parts on the cooker to produce noise when in use.   |
| Oven light (if available) does not operate.        | <p>Lamp has failed.</p> <p>Electrical supply is disconnected or switched off.</p>   | <p>Replace lamp according to the instructions.</p> <p>Make sure the electrical supply is switched on at the wall socket outlet.</p>   |

|  |   |  |
|--|---|--|
| <p>The timer buttons cannot be pressed properly.</p> | <p>There is foreign matter caught between the timer buttons.<br/>         Touch model: there is moisture on the control panel.<br/>         The key lock function is set.</p> | <p>Remove the foreign matter and try again.<br/>         Remove the moisture and try again.<br/>         Check whether the key lock function is set.</p> |
|--|---|--|

## 6.2 Transport

If you need to transport the product, use the original product packaging and carry it using its original case. Follow the transport signs on the packaging. Tape all independent parts to the product to prevent damaging the product during transport.

If you do not have the original packaging, prepare a carriage box so that the appliance, especially the external surfaces of the product, is protected against external threats.

## 7. TECHNICAL SPECIFICATIONS

### 7.1 Injector Table

|                            |                   |
|----------------------------|-------------------|
| I2H GB Class: 1            | NG<br>G20 20 mbar |
| LARGE BURNER               |                   |
| DIA. of INJECTOR (1/100mm) | 115               |
| NOMINAL RATING (kW)        | 2,9               |
| CONSUMPTION                | 276 l/h           |
| MEDIUM BURNER              |                   |
| DIA. of INJECTOR (1/100mm) | 97                |
| NOMINAL RATING (kW)        | 1,75              |
| CONSUMPTION                | 166.7 l/h         |
| MEDIUM BURNER              |                   |
| DIA. of INJECTOR (1/100mm) | 97                |
| NOMINAL RATING (kW)        | 1,75              |
| CONSUMPTION                | 166.7 l/h         |
| SMALL BURNER               |                   |
| DIA. of INJECTOR (1/100mm) | 72                |
| NOMINAL RATING (kW)        | 1                 |
| CONSUMPTION                | 95.2 l/h          |
| MAIN OVEN BURNER           |                   |
| DIA. of INJECTOR (1/100mm) | 115               |
| NOMINAL RATING (kW)        | 2,4               |
| CONSUMPTION                | 228,6 l/h         |
| TOP OVEN BURNER            |                   |
| DIA. of INJECTOR (1/100mm) | 115               |
| NOMINAL RATING (KW)        | 2,4               |
| CONSUMPTION                | 228,6 l/h         |

## 7.2 Energy Fiche

|   |   |                          |  |
|---|---|--------------------------|--|
|   | Brand                                   |                          |  |
|   | Model                                   |                          | BEL FSG608DMc Sta  |
|   | Type of Oven                            |                          | GAS  |
|   | Mass                                    | kg                       | 49(+/-2)   |
| Upper Cavity  | Energy Efficiency Index - conventional  |                          | 104,5  |
|   | Energy Efficiency Index - fan forced    |                          | -  |
|   | Energy Class                            |                          | A  |
|   | Energy consumption (gas) - conventional | MJ/cycle - kWh/<br>cycle | 5,10<br>1,42   |
|   | Energy consumption (gas) - fan forced   | MJ/cycle - kWh/<br>cycle | -  |
|   | Heat Source                             |                          | GAS  |
|   | Volume                                  | l                        | 31   |
| Lower Cavity  | Energy Efficiency Index - conventional  |                          | 78,3   |
|   | Energy Efficiency Index - fan forced    |                          | -  |
|   | Energy Class                            |                          | A+   |
|   | Energy consumption (gas) - conventional | MJ/cycle - kWh/<br>cycle | 5,00<br>1,39   |
|   | Energy consumption (gas) - fan forced   | MJ/cycle - kWh/<br>cycle | -  |
|   | Heat Source                             |                          | GAS  |
|   | Volume                                  | l                        | 65   |
|   | Number of cavities                      |                          | 2  |
|   | This oven complies with EN 15181        |                          |  |
|   |   |                          |  |
| <p>Energy Saving Tips</p> <p>Oven</p> <ul style="list-style-type: none"> <li>- Cook the meals together, if possible.</li> <li>- Keep the pre-heating time short.</li> <li>- Do not elongate cooking time.</li> <li>- Do not forget to turn-off the oven at the end of cooking.</li> <li>- Do not open oven door during cooking period.</li> </ul> |   |                          |  |

### 7.3 Energy Fiche

|  |    |  |
|--|----|--|
| Brand  |    |  |
| Model  |    | BEL FSG608DMc Sta  |
| Type of Hob  |    | Gas  |
| Number of Cooking Zones  |    | 4  |
| Heating Technology-1   |    | Gas  |
| Size-1   | cm | Auxiliary  |
| Energy Efficiency-1  | %  | NA   |
| Heating Technology-2   |    | Gas  |
| Size-2   |    | Semi-Rapid   |
| Energy Efficiency-2  | %  | 59,0   |
| Heating Technology-3   |    | Gas  |
| Size-3   | cm | Semi-Rapid   |
| Energy Efficiency-3  | %  | 59,0   |
| Heating Technology-4   |    | Gas  |
| Size-4   |    | Rapid  |
| Energy Efficiency-4  | %  | 57,0   |
| Energy Efficiency of Hob   | %  | 58,3   |
| This hob complies with EN 30-2-1   |    |  |
| <p>Energy Saving Tips</p> <p>Hob</p> <ul style="list-style-type: none"> <li>- Use cookware with a flat base.</li> <li>- Use the correct size cookware.</li> <li>- Use cookware with a lid.</li> <li>- Minimize the amount of liquid or fat.</li> <li>- When liquid starts boiling , reduce the setting.</li> </ul> |    |  |



# Customer Care

Please keep this handbook in a safe place as the information inside may be of use should you sell, or pass on the appliance. Please fill in the model number and serial number in the spaces provided below as they will assist us should you need to call.

## 0344 815 3746

When you dial this number, you will hear a recorded message and be given several options. This indicates that your call has been accepted and is being held in a queue. Calls are answered in strict rotation as our Customer Care representatives become available.

Enter appliance numbers here for future reference:

|                  |   |   |  |  |  |  |  |  |  |
|------------------|---|---|--|--|--|--|--|--|--|
| <b>Model No</b>  |   |   |  |  |  |  |  |  |  |
| 4                | 4 | 4 |  |  |  |  |  |  |  |
| <b>Serial No</b> |   |   |  |  |  |  |  |  |  |
|                  |   |   |  |  |  |  |  |  |  |

These numbers can be found on your appliances data badge. Outside the UK and Northern Ireland, refer to your local supplier.



Stoney Lane, Prescot, Merseyside, L35 2XW.

CE



10714725 lb

