

| C | D | A |

SC030

Built-in multifunction oven

Use and maintenance

Contents

3	Important information
4	Appliance information
5	First use of the oven
6	Oven layout and accessories
8	Control panel
9	Oven functions
11	Setting the time
13	Adjusting the display brightness
14	Using the grill
15	ECO heating
16	Practical tips
17	Cleaning and maintenance
21	Installation
23	Mains electrical connection
25	Technical assistance
26	Specifications
27	Product fiche
28	Product information

IMPORTANT: Please read the user instructions carefully before using the appliance for the first time and before installing it.

Failure to install the oven, or to have it installed, as per the instruction manual could invalidate the warranty. Any service calls relating to misuse or incorrect installation could incur a service charge.

Important information

This appliance must only be used for the purpose for which it is intended, i.e. domestic cooking. Any other use could be dangerous and may lead to premature failure of the appliance.

The CDA Group Ltd. cannot be held responsible for injuries or losses caused by incorrect use or installation of this product. Please note that CDA reserves the right to invalidate the guarantee supplied with this product following incorrect installation or misuse of the appliance.

Under no circumstances should any external covers be removed for servicing or maintenance except by suitably qualified personnel.

User information

- The appliance and its accessible parts become hot during use
- Care should be taken to avoid touching heating elements
- The appliance can be used by children aged from 8 years and above. Persons with reduced physical, sensory or mental capabilities must be given instruction or supervision concerning safe operation of the appliance and understand the hazards involved
- Do not allow anyone unfamiliar with the contents of this instruction manual to operate the oven
- Do not use harsh cleaning agents or sharp metal objects to clean the door as they can scratch the surface potentially resulting in cracking or shattering of the glass
- Take care when opening the oven door during or after a cooking cycle as hot steam may escape
- Do not use the oven in the event of a technical fault. Any faults must be fixed by an appropriately qualified and authorised person
- In the event of an incident due to a technical fault, disconnect the power and report the fault to CDA Customer Care
- The appliance has been designed only for cooking, any other use may invalidate your warranty and cause danger
- Do not place anything weighing over 15kg on the opened oven door

Appliance information

Please enter the details on the appliance rating plate below for reference, to assist CDA Customer Care in the event of a fault with your appliance and to register your appliance for guarantee purposes.

Appliance Model	
------------------------	--

Serial Number	
----------------------	--

EU Declarations of Conformity:

This appliance has been manufactured to the strictest standards and complies with all applicable legislation and the following European Directives.

- The Low Voltage Directive 2014/35/EU
- Electromagnetic Compatibility Directive 2014/30/EU
- ErP Directive 2009/125/EU



The product has been marked with the **CE** symbol and the Declaration of Conformity has been issued to the manufacturer and is available to the competent authorities regulating the market

IMPORTANT INFORMATION FOR CORRECT DISPOSAL OF THE PRODUCT IN ACCORDANCE WITH EC DIRECTIVE 2012/19/EU.

At the end of its working life, the product must be taken to a special local authority waste collection centre or to a dealer providing appliance recycling services.

Disposing of a household appliance separately avoids possible negative consequences for the environment and health. It also enables the constituent materials to be recovered, saving both energy and resources. As a reminder of the need to dispose of household appliances separately, the product is marked with a crossed-out wheeled dustbin .

First use of the oven

In order to remove oil residues accumulated during the manufacturing process and dust accumulated during storage and transport, we recommend a preliminary cleaning before first use.

Preliminary heating

1. Remove any packaging elements from the oven cavity
2. Turn on ventilation or the extractor fan in the room or open a window
3. Set the oven to 250°C using the rapid preheating function
4. Allow to heat for approximately 30 minutes
5. Turn the oven off and allow to cool
6. To clean the oven use a damp cloth with warm water and a small amount of washing up liquid
7. Dry with a clean cloth

A slightly unpleasant smell may be emitted during this process due to the vaporising of oil residue used to protect the oven during storage.



Important! The time “0.00” will start flashing in the display upon connection to the power supply.

The programmer should be set with the current time. (See Electronic programmer). If the current time is not set operation of the oven is not possible.

The electronic programmer is equipped with touch sensors which are switched on by touching or pressing the sensor surface for at least one second.

Each sensor reaction is confirmed by the beep.
Keep the sensor surface clean at all times.

Oven layout and accessories

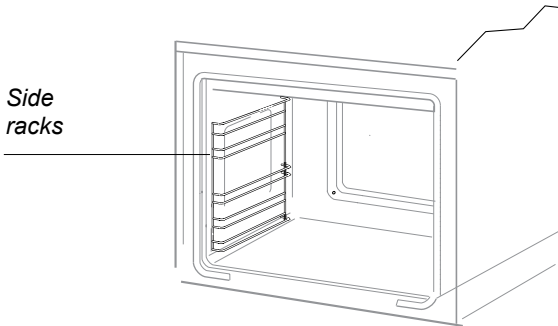
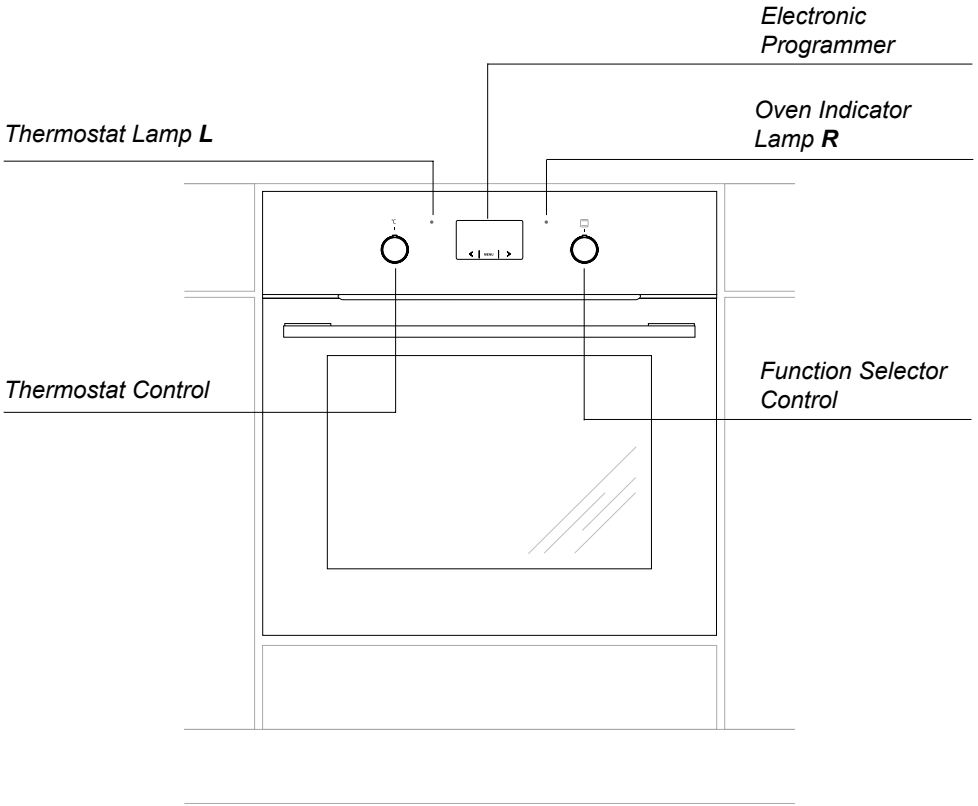

Included accessories:

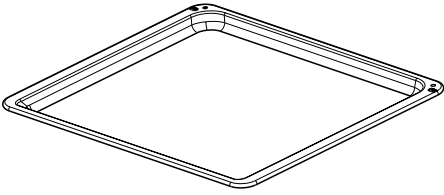

Baking tray

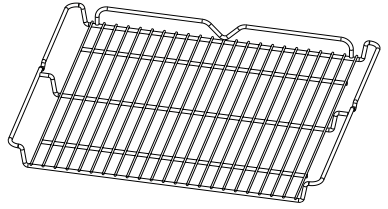

Wire shelf

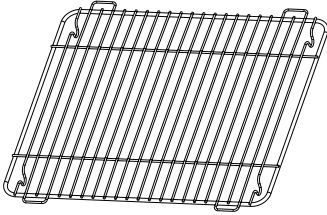



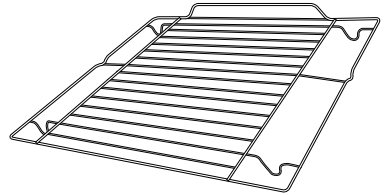

Grill rack

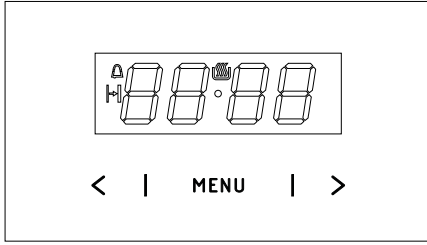

Wire shelf

Control panel



- MENU** Select the mode of operation
- >** Higher setting sensor
- <** Lower setting sensor
-  Appliance on indicator
-  Kitchen timer
-  Duration

Operation

Operation of the oven is controlled by the oven function knob – to set a required function you should turn the knob to the selected position, and the temperature regulator knob – to set the temperature, turn the thermostat control clockwise.

The oven can be switched off by setting both of these Controls to the position “●”/“○”.

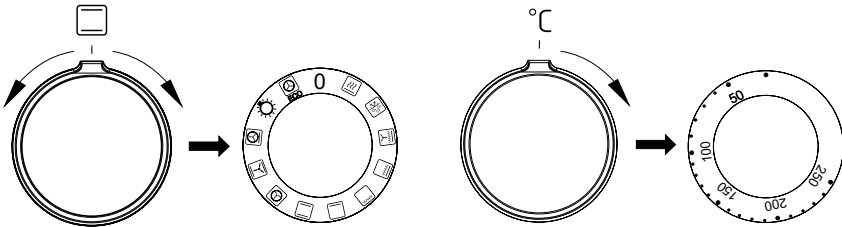

Caution! When selecting any heating function (switching a heater on etc.) the oven will only be switched on after the temperature has been set by the Thermostat Control.

Oven functions



Rapid preheating

Use to preheat the oven.



Defrost

This function uses the fan to circulate air, at ambient temperature within the oven which helps to accelerate the defrosting process.



Fanned grill

This function radiates heat from the grill element and the top element but also uses the fan to circulate hot air. The hot air is distributed over and under the food that you are grilling. This fully temperature variable grill is ideal for grilling fish or other items where the appearance could be spoiled by a normal grill function. It can be set between 50°C and 190°C maximum.



Half grill

This function radiates heat from the grill element. This fully temperature variable grill can be set between 50°C and 250°C maximum.



Full grill

In this setting both the grill and top element are engaged. This increases the temperature in the top part of the oven chamber making it suitable for browning and roasting larger portions of food. It can be set between 50°C and 250°C maximum.



Warming oven

This function radiates heat from the bottom element, baking cakes from underneath until done.



Conventional oven

The thermostat enables the user to set the temperature within a range of 100°C to 250°C. This setting is ideal for baking cakes, meat, fish, bread and pizza. For best results preheat the oven and use a baking tray on one level.



Fan oven

This function uses the circular heating element with a temperature between 50°C and 250°C. The fan then circulates the hot air which helps to achieve uniform heat distribution.



Fan assisted oven

This setting is most suitable for baking cakes.



Fan cooking with lower heat

With this setting the convection fan and bottom heater are on, which increases the temperature at the bottom of the cooked dish. Intense heat from the bottom, moist cakes, pizza.



Light

The oven light will be turned on.



Eco fan assisted heating

This is an optimised heating function designed to save energy. When using this function the oven light is intentionally left off.

Switching on the oven is indicated by two signal lights, **R (orange)**, **L (red)**, turning on.

The orange light turned on means the oven is working.

If the red light goes out, it means the oven has reached the set temperature.



If a recipe recommends placing dishes in a warmed-up oven, this should be not done before the red light goes out for the first time.

When baking, the red light will temporarily come on and go out (to maintain the temperature inside the oven). The orange signal light may also turn on at the knob position of “oven chamber lighting”.

Setting the time

When the appliance is plugged into the electrical mains supply, or when power is restored after a power cut, the digital display will flash 0.00.





- Touch and hold **MENU** (or simultaneously touch **</>**) until  is shown on the display and the dot below the symbol is flashing
- Touch **</>** within 7 seconds to set the current time.

To store the new time setting, wait approximately 7 seconds after the time has been set. The dot below the  symbol will stop flashing. You can adjust the time later. To do this touch **</>** simultaneously and adjust the current time while the dot below the  symbol is flashing.

Note: The oven can be operated only when you see the  symbol is shown.

You can activate the Kitchen Timer at any time, regardless of the status of other functions. The Kitchen Timer can be set from 1 minute up to 23 hours and 59 minutes.

To set the Kitchen Timer:



- Touch **MENU**, then the display will show blinking 
- Use the **</>** sensors to set the Kitchen Timer. The display will show the set time and Kitchen Timer symbol  .
Once the set time elapses, alarm will sound and the  icon will flash.
- Touch and hold **MENU** or simultaneously touch and hold **</>** to mute the alarm, the  will be off and the display will show the current time.

Note: If no button is touched, alarm will turn off automatically after approximately 7 minutes.

Minute minder

To set the appliance to switch off after a specific duration:

- Set the function knob and the temperature control knob to your preferred settings.
- Touch **MENU** repeatedly until the display shows *dur* (duration) briefly and the  symbol will be flashing.
- Set the desired duration from 1 minute to 10 hours using the **</>** sensors.

The set duration will be stored after approx. 7 seconds. The display will show the current time and the  symbol. Once the duration has elapsed the oven will turn off automatically. An alarm will sound and the  symbol will be flashing.

- Set the oven function selector knob and the temperature selector knob to the off position.
- Touch and hold **MENU**, or simultaneously touch and hold **</>** to mute the alarm, the  will be off and the display will show the current time.

Cancel settings

The Timer and Timed operation settings may be cancelled at any time.

Cancel Timed operation settings:

- Simultaneously touch and hold the **</>** sensors.

Cancel timer settings:

- Touch the **MENU** sensor to select the Kitchen Timer.
- Simultaneously touch the **</>** sensors.

Change the beep tone

You can change the beep tones as follows:

- Simultaneously touch the **</>** sensors
- Touch **MENU** repeatedly to select the *ton* (tone).
The display will be flashing.
- Use the **</>** sensors to select your preferred tone:
Use **>** to select the setting 1 to 3
Use **<** to select the setting 3 to 1

Adjusting the display brightness

You can adjust the display brightness 1 to 9, where 1 is the darkest and 9 is the brightest. The brightness setting applies to an inactive control panel, i.e. when no controls are touched for 7 seconds. You can adjust the display brightness as follows:

- Simultaneously touch the **</>** sensors,
- Touch **MENU** repeatedly to select the *bri* (brightness) setting — the settings can be accessed in sequence *ton* (tone) and *bri* (brightness).
- Use the **</>** sensors to select your preferred brightness:
 - Use **>** to select the setting from 1 to 9
 - Use **<** to select the setting from 9 down to 1

Note: The display is at its brightest setting when active, i.e. a control was touched within the last 7 seconds.

Night Mode

The display is automatically dimmed during the night hours 22:00 — 06:00.

Using the grill

In order to switch on the grill you need to:

- Set the Function Selector Control to a full or half grill position.
- Preheat the oven for approx. 5 minutes (with the oven door closed).

For grilling with the function grill and super grill the temperature must be set to 220°C, but for the function fanned full grill it must be set to a maximum of 190°C.



Warning! When using function grill it is recommended that the oven door is closed. When the grill is in use accessible parts can become hot. It is best to keep children away from the oven

ECO heating

ECO heating is an optimised heating function designed to save energy when preparing food.

You cannot reduce the cooking time by setting a higher temperature; preheating the oven is not recommended.

Do not change the temperature setting and do not open the oven door during cooking.

Recommended settings for ECO heating

















Type of dish	Oven function	Temperature °C	Level	Time (min)
Sponge cake	ECO	180 - 200	2-3	50 -70
Muffins	ECO	180 - 200	2	50 -70
Fish	ECO	190 - 210	2-3	45 - 60
Beef	ECO	200 - 220	2	90 - 120
Pork	ECO	200 - 220	2	90 - 160
Chicken	ECO	180 - 200	2	80 - 100

Practical tips

The times given in the table below apply to any dish that is placed in to a cold oven.

For a preheated oven the times should be reduced by 5 - 10 minutes.

The figures given below are approximate and can be altered based on your own experience and cooking preferences.

Type of dish	Heating Function	Level	Time [Min]	Temperature [°C]
Sponge cake		2 - 3	30 - 50	160 - 200
Muffins		3	25 - 40 ²⁾	160 - 170 ¹⁾
Muffins		3	25 - 40 ²⁾	155 - 170 ¹⁾
Pizza		2 - 3	15 - 25	200 - 230 ¹⁾
Fish		2	45 - 60	210 - 220
Fish		2 - 3	45 - 60	160 - 180
Fish		2 - 3	60 - 70	190
Sausages		4	14 - 18	220
Beef		2	120 - 150	225 - 250
Beef		2	120 - 160	160 - 180
Pork		2	90 - 120	160 - 230
Pork		2	90 - 120	160 - 190
Chicken		2	70 - 90	180 - 190
Chicken		2	45 - 60	160 - 180
Chicken		2	60 - 70	175 - 190
Vegetables		2	40 - 50	190 - 210
Vegetables		3	40 - 50	170 - 190

1) Preheat

2) Baking smaller items

Cleaning and maintenance

Keeping your oven clean and well maintained helps to prolong its life. It is important that, before any cleaning or maintenance is performed, you switch off the oven at the mains supply. Do not start any cleaning or maintenance until the oven has been allowed to cool completely.

Door removal

In order to gain better access to the oven cavity for cleaning, it is possible to remove the door. To do this, lift the safety catch part of the hinge upwards (fig. A). Close the door lightly, lift and pull it out towards you. In order to fit the door back on to the oven, follow the steps in reverse,

When fitting, ensure that the notch of the hinge is correctly placed on the hinge holder. After the door is fitted to the oven, the safety catch should be carefully lowered down again. If the safety catch is not set it may cause damage to the hinge when closing the door.

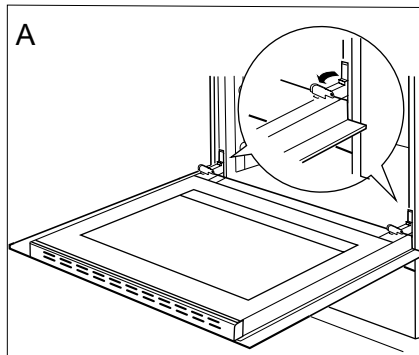

Lifting the hinge safety catches

Removing the inner panel

1. Using a flat screwdriver unhook the upper door slat, prying it gently on the sides (fig. B).
2. Pull the upper door slat loose. (fig. B, C)

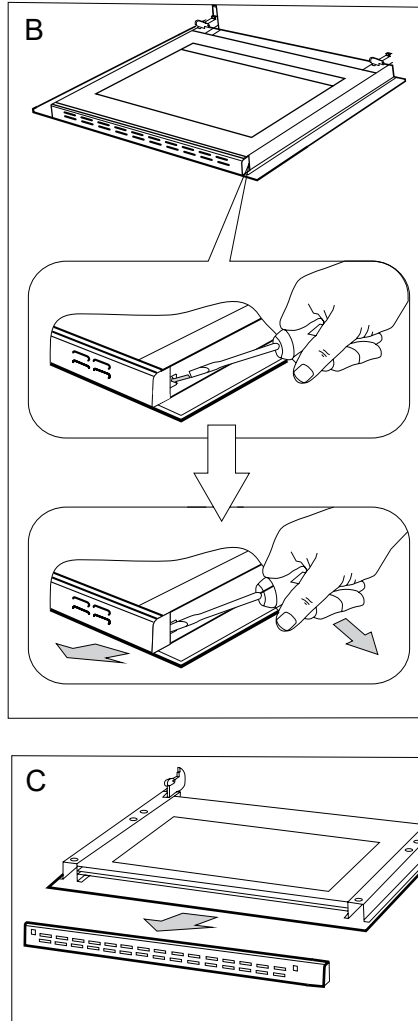

3. Slide the inner glass out noting the position of any rubber spacers (fig. D).
4. Clean the panel with warm water with some cleaning agent added.

Carry out the same in reverse order to reassemble the inner glass panel. Its smooth surface shall be pointed upwards.

Important! Do not force the upper strip in on both sides of the door at the same time. In order to correctly fit the top door strip, first put the left end of the strip on the door and then press the right end in until you hear a “click”. Then press the left end in until you hear a “click”.

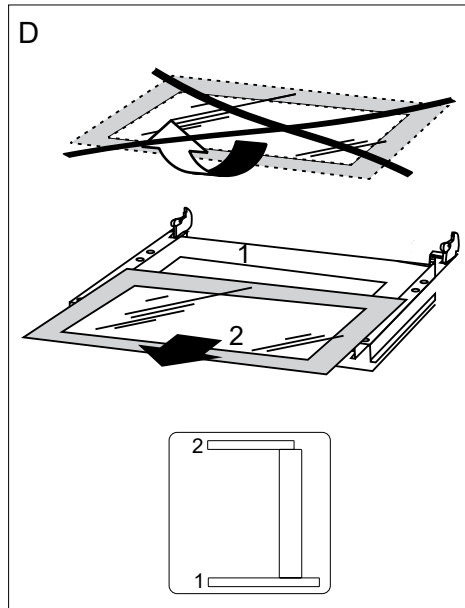

Removal of the internal glass panel

Replacing the halogen bulb in the oven

Before replacing the halogen bulb, make sure the appliance is disconnected from the mains electricity to avoid the risk of electric shock.

- Set all control knobs to the position “●”/“0” and disconnect the mains plug
- Unscrew and wash the lamp cover and then wipe it dry
- Pull the halogen bulb out using a cloth or paper, if necessary, replace the halogen bulb with a new one
 - voltage 230V
 - power 25W
 - G9
- Replace the halogen bulb in its socket
- Screw in the lamp cover

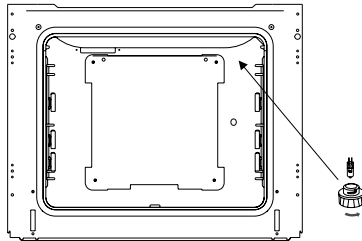

Oven lighting

Installation

The installation and technical assistance must only be performed by qualified staff.

Carefully read the safety instructions in this manual before using the oven. Incorrect installation, maintenance, assistance and use can cause serious damage/injury to persons or objects.

This product must be installed as instructed in this manual and in compliance with National Standards and local regulations in force. Do not lift or pull the oven from the door handle and do not force or load weights when this is open. The purchaser is responsible for installation. Assistance provided by the manufacturer due to incorrect installation is excluded from the warranty.

Features of the cabinet

- The kitchen area should be dry, aired and equipped with efficient ventilation
- When installing the oven, ensure there is access to all control elements
- The cabinet and its components must be able to withstand temperatures of up to 90 °C without presenting deformities and/ or surface defects
- The cabinet must enable the free passage of the mains electrical cables
- Hoods should be installed according to the manufacturer's instructions

Inserting the oven in the cabinet

- Make an opening with the dimensions given in the diagram for the oven to be fitted
- Make sure the mains plug is disconnected and then connect the oven to the mains supply

- Insert the oven completely into the opening without allowing the four screws in the places shown in the diagram to fall out
- Ensure the oven is safely installed inside the cabinet
- Use screws to fix the oven to the front face of the cabinet

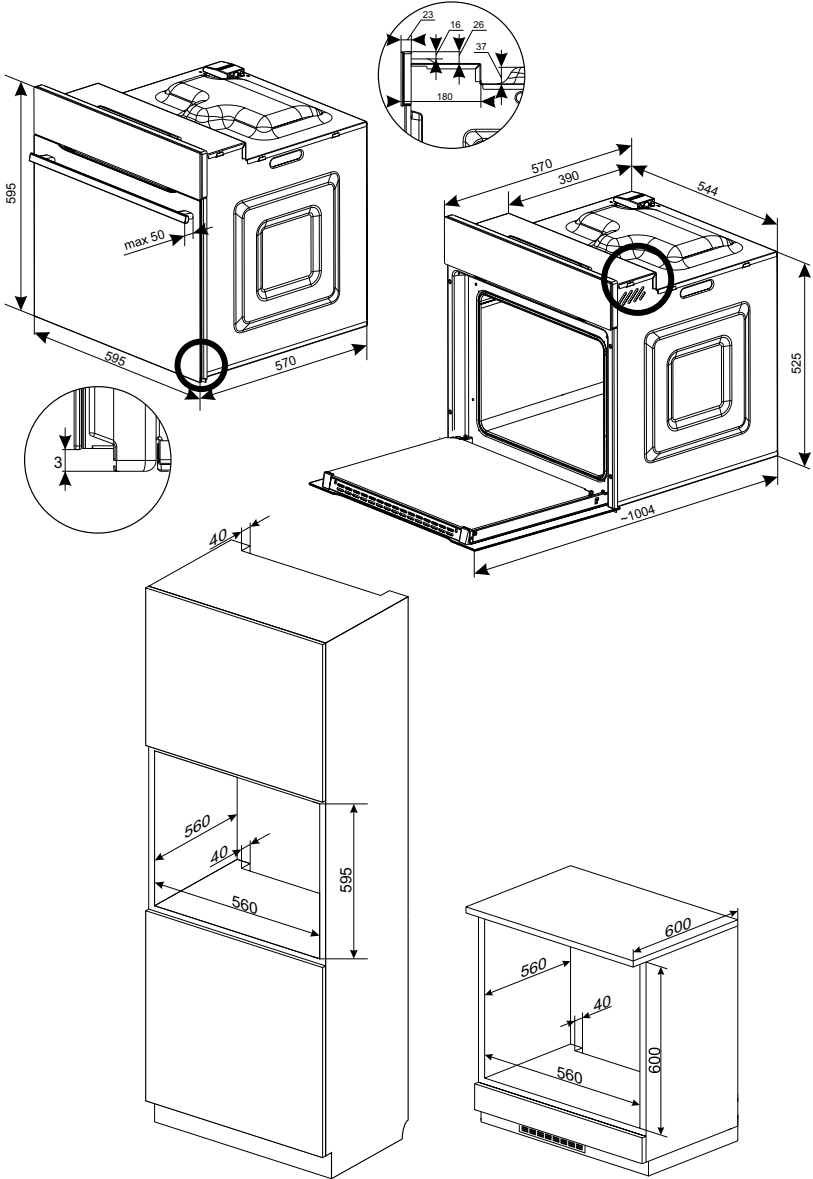

Mains electrical connection

Warning! This appliance must be earthed.

This appliance is intended to be connected to fixed wiring by a double pole switch, having a contact separation of at least 3mm in all poles and protected by a 13A fuse. The switch must be positioned no further than 2m from the appliance.

We recommend that the appliance is connected by a qualified electrician, who is a member of the N.I.C.E.I.C. and who will comply with the I.E.T. and local regulations. The wires in the mains lead are coloured in accordance with the following code:

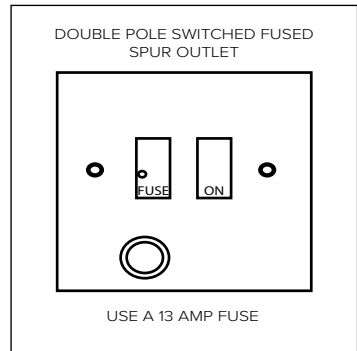

GREEN AND YELLOW = EARTH
BLUE = NEUTRAL
BROWN = LIVE

As the colours of the wires in the mains lead for the appliance may not correspond with the coloured markings identifying the terminals in your spur box, proceed as follows:

1. The wire which is coloured green and yellow must be connected to the terminal marked E (Earth) or coloured green
2. The wire which is coloured blue must be connected to the terminal marked N (Neutral) or coloured black
3. The wire which is coloured brown must be connected to the terminal marked L (Live) or coloured red

Please note:

- The mains cable must only be replaced by a qualified electrician or service engineer and must be of equivalent or better rating (i.e. $3 \times 1.5 \text{ mm}^2$, HO5VV-F).

- This appliance is intended to be connected to the mains supply with a cable of cross sectional area 1.5 mm^2
- The current rating of the fuse or circuit breaker protecting this appliance should be marked on the socket outlet
- Assembly and electrical connection should be carried out by specialised personnel
- When installing this product we recommend you seek the help of another individual
- Should the mains cable be damaged or need to be replaced, it should only be done so by a qualified electrician or engineer
- The terminal block on the appliance is clearly marked with regards to the positions of live, neutral and earth

Technical assistance

In the event of your appliance requiring technical assistance and/or spare parts, please contact CDA Customer Care. For more information about the warranty of your product, including terms and conditions, please visit www.cda.co.uk/warranty

CDA Customer Care

Phone: 01949 862 012

Email: customer.care@cda.co.uk

In case your oven requires technical assistance and/or spare parts, contact the dealer or the authorised technical assistance centre nearest to you. In this case it is also necessary to state all the appliance data on the rating plate, such as: model, serial number, etc, rating plate is placed on the back of the oven and on the last page of the instructions booklet or warranty card.

Problem	Reason	Solution
The appliance does not work	No power	Check the fuse, replace if blown
Oven lighting does not work	Loose or damaged bulb	Replace bulb if blown (see cleaning and maintenance)
Display shows 0.00	The oven was disconnected from the mains or there was a temporary power cut	Set the current time (see page 11)
Fan does not work	Risk of overheating! Unplug the appliance immediately or switch off the main circuit breaker. Contact the Customer Care Department	

If the problem is not solved, disconnect the power supply and report the fault.

Important! All repairs must be performed by qualified service technicians.

Specifications



Model	SC030
Oven Dimensions (HxWxD)	595 x 595 x 575 mm
Rated voltage	230 V ~50 Hz
Total power	2800 W
grill	1900 W
bottom heater	900 W
grill + top heater	2700 W
Fan with ring heating element	1850 W

The product meets the requirements of European standards EN 60335- 1; EN60335-2-6.

The data on the energy labels of electric ovens is given according to standard EN 60350-1 / IEC 60350-1. These values are defined with a standard workload and with the functions active:

bottom and top heaters (conventional heating) and fan assisted heating (forced air heating), if these functions are available.

The energy efficiency class was assigned depending on the function available in the product in accordance with the priority below:

Forced air circulation ECO (ring heater & fan)	 ECO
Forced air circulation ECO (bottom heater + top + grill + fan)	 ECO
Conventional mode ECO (bottom heater + top)	 ECO

Product fiche

The information in the product data sheet is given in accordance with the Commission Delegated Regulation (EU) NO 65/2014 supplementing Directive of the European Parliament and of the Council 2010/30/EU with regard to energy labelling of household ovens and range hoods.

Supplier name	CDA
Model identifier	SC030 10227.3eEHITsDSm
Energy efficiency index (EEI cavity)	95.1
Energy efficiency class	A
Energy consumption per cycle (EC electric cavity)	0.99
Conventional mode [kWh]	0.78
Fan-forced mode [kWh]	
Number of cavities	1
Heat source (electricity or gas)	Electric
Cavity volume (L)	65

In order to determine compliance with the eco-design requirements, the measurement methods and calculations of the following standard were applied:

EN 60350-1

Product information

Product information given in accordance with Commission Regulation (EU) No 66/2014 supplementing Directive of the European Parliament and Council Directive 2009/125/EC with regard to eco-design requirements for household ovens, hobs and range hoods.

Model identifier	SC030 10227.3eEHITsDSm
Oven type (electricity or gas)	Electric
Appliance weight [kg]	33.5
Number of cavities	1
Heat source (electricity or gas)	Electric
Cavity volume (L)	65
Energy consumption needed to heat a standard charge in an electric oven cavity during a single cycle in conventional mode for each cavity (final electric energy consumption) EC electric cavity [kWh/cycle]	0.99
Energy consumption needed to heat a standard charge in an electric oven cavity during a single cycle in fan-forced mode for each cavity (final electric energy consumption) EC electric cavity [kWh/Cycle]	0.78
Energy efficiency index EEI cavity	95.1

Product information given in accordance with Commission Regulation (EU) No 2019/2015:

This product contains a light source of energy efficiency class G.

Light source in this product can be replaced by the end-user.

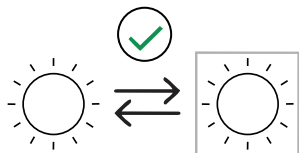

Notes

The CDA Group

Harby Road

Langar

Nottinghamshire

NG13 9HY

Sales Department

Phone: 01949 862010

Email: sales@cda.co.uk

Customer Care Department

Phone: 01949 862012

Email: customer.care@cda.co.uk

