

pencilwash

User guide

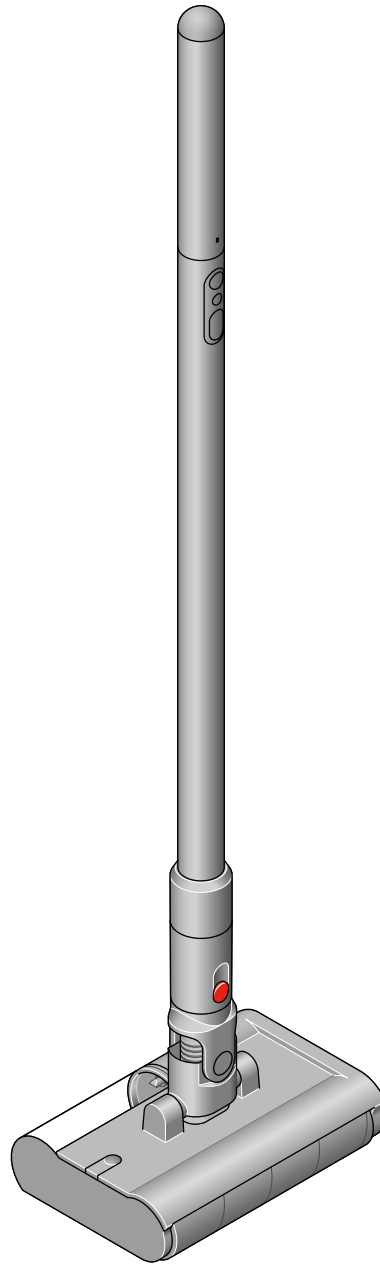

Contents

In the box

Getting started

The LED Screen

How to prepare your

PencilWash™ cleaner

How to use your PencilWash™ cleaner

Maintenance

Looking after your machine

Disassembling your machine

Support and service

In the box

Your machine is boxed in 3 parts:

1. Battery
2. PencilWash™ wand
3. PencilWash™ cleaner head

Click the battery to the top end of the wand. Attach the wand to the cleaner head. Fully charge before first use.



Battery



PencilWash™ wand

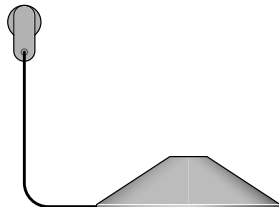

Wand charging dock

Charging dock with stand, plug, connector and cable. Charges your machine ready for your next clean.

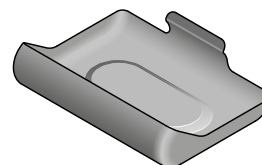

Cleaner head clip-on drip tray

To store and transport the PencilWash™ cleaner head.

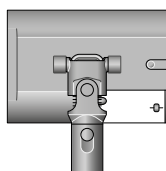

PencilWash™ cleaner head

Remove spills and stains from hard floors with the PencilWash™ cleaner head.

Getting started

Get to know your machine's controls

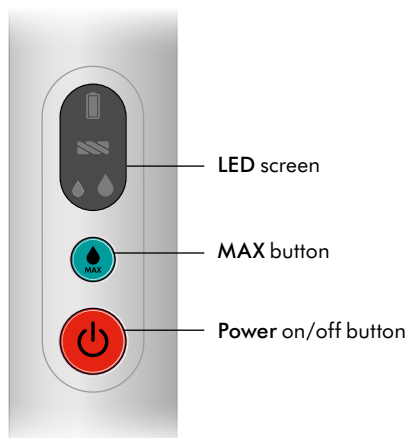

Modes



Step 1
Click the battery into the top part of the wand until it locks in place.

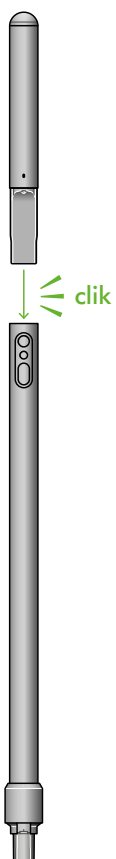

Step 2
Place the wand on the wand charging dock and fully charge before first use.

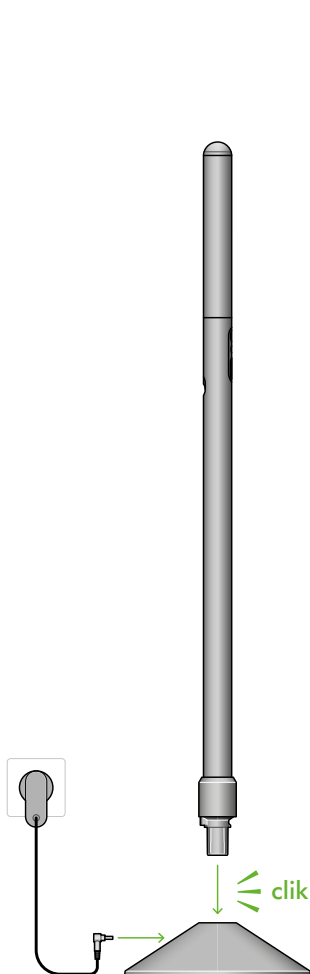

Step 3
Click the wand into the cleaner head.

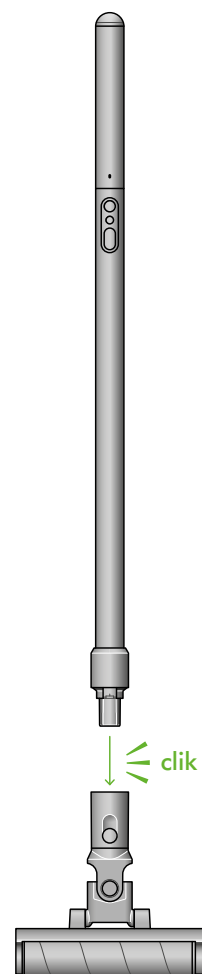

The LED screen

The LED screen displays helpful information and alerts, such as the selected mode and battery status.

Cleaning

Press the power button to begin cleaning.

Choose the power mode to suit the task.
Standard or MAX.



Standard mode

For everyday cleaning, light spills and debris.
Your machine's default mode.



MAX mode 1

For spot-cleaning stains and dried-on dirt.

Press and release the MAX button once to activate. The mode will last for 5 seconds before returning to the default mode.



MAX mode 2

For cleaning larger areas of stains and dried-on dirt.

Press and hold the MAX button to activate. The mode will last for a maximum of 60 seconds, or until you release the button, before returning to the default mode.

Tip: Use MAX mode sparingly to prevent rapid depletion of clean water tank.

Battery is low (5%-10%)

LED is solid orange.



Battery is critical (<5%)

LED is orange and blinking quickly.



Battery is charging

LED is blue and blinking.



Non-Dyson battery detected

LED is solid white.



Main body fault

LED is red and blinks for 5 seconds.



How to prepare your PencilWash™ cleaner

Step 1

Hold the wet roller head level and upright. Press and hold the red quick-release button and slide out the removable cassette from the main body. This cassette includes the roller, clean water tank, and waste tray.

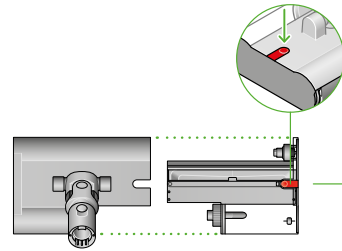

Step 2

Once removed, turn the cassette so that the clean water tank cap faces upwards. Unscrew the cap.

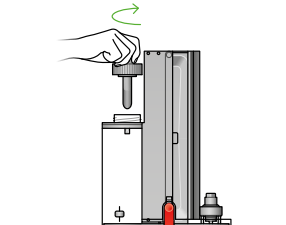

Step 3

Fill the clean water tank with water to the 'MAX' line, or just below if adding cleaning solution.

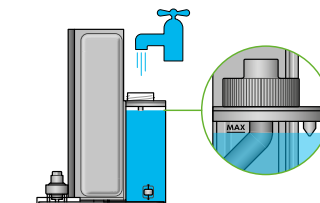

Step 4

Add 10ml of O2 Probiotic Cleaning solution or non-foaming detergent. This step is optional.

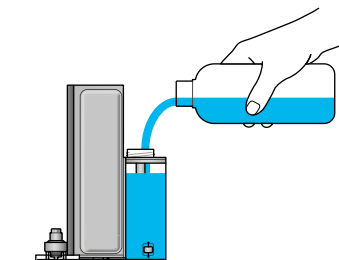

Step 5

Once full, refit the cap securely on the clean water tank.

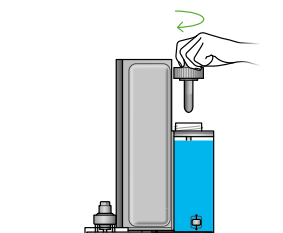

Step 6

Before first use, detach the roller and thoroughly hydrate under running water. Squeeze away any excess liquid and refit to the cassette.

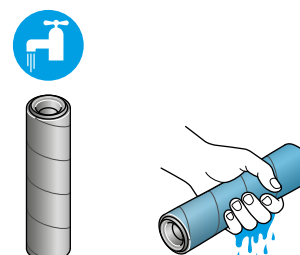

How to use your PencilWash™ cleaner

Step 1

Refit the removable cassette into the main body of the cleaner head. Ensure the rail of the cassette aligns with that of the main body to ensure a correct fit. You should hear a click once securely fitted. Then, attach the wet roller head to your machine's wand.

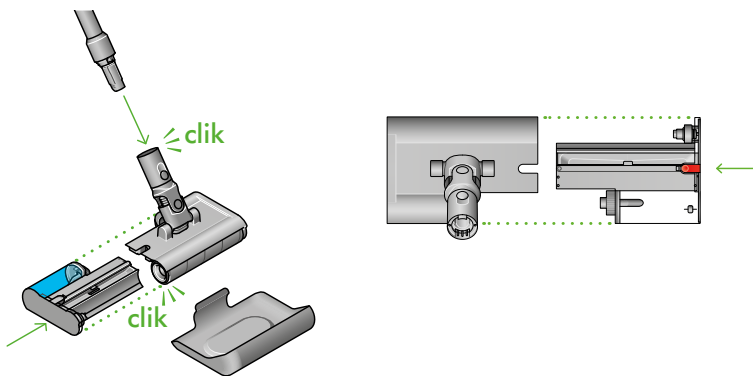

Step 2

Start your machine by pressing the power button. Allow 10 seconds for the roller to be fully hydrated.

You can use your machine until the clean water tank runs low or the battery runs out. To resume cleaning after one of these events, simply empty the waste tray, refill your clean water tank and/or recharge the wand.

Do not attempt to use your machine with an empty clean water tank.



Step 3

Your machine starts with Standard mode as default.

Press and release the MAX button once to activate the mode for 5 seconds, or press and hold the MAX button to activate MAX mode for a maximum of 60 seconds.

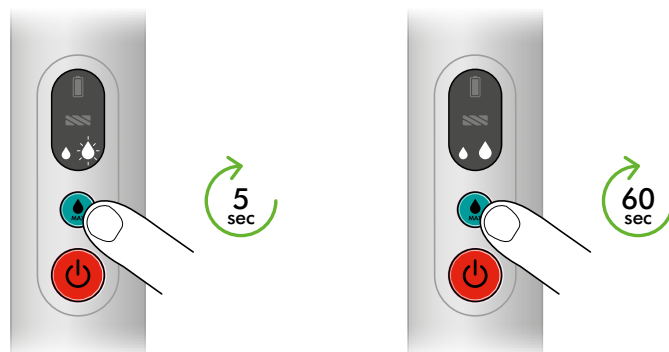

Cleaning tips

For maximum pickup, move your machine at a slow pace across the debris and spills. For best results, clean in overlapping passes.

Maintenance

Recommended after every use

Step 1

Turn off your machine and detach your Dyson PencilWash™ cleaner head from the wand. Place the cleaner head in the drip tray immediately to prevent dirty water spillage.

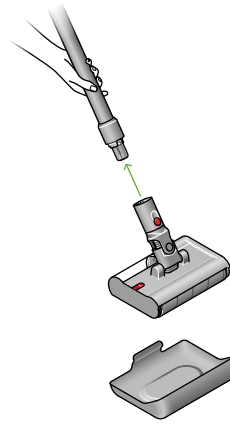

Step 2

Hold the cleaner head level in the drip tray when transporting to the sink to clean.

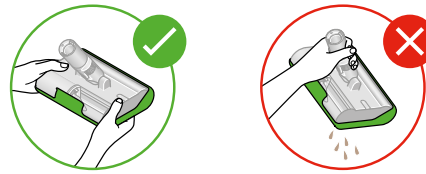

Step 3

Hold the cleaner head over a sink. Remove it from the drip tray.

Hold the wet roller head level and upright. Press and hold the red quick-release button and slide out the removable cassette from the main body.

Next, remove the long red rectangular cover and empty the waste tank.

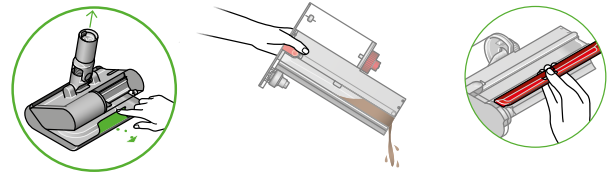

Step 4

Disassemble your PencilWash™ cleaner head into the parts seen here. Every part of the cleaner head (excluding the neck) can be washed with water and a household anti-bacterial solution, diluted according to the manufacturer's recommended ratio.

Do not get water on the neck of your cleaner head, as it may damage its connection to the wand.

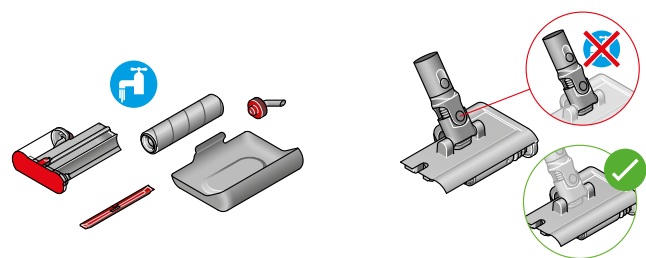

Step 5

After washing, leave the wet roller upright, as shown, to air-dry in a warm, well-ventilated space. Leave for at least 24 hours.

Use a cloth to wipe away any dirt or excess water from the main body of the cleaner head, waste tray and clean water tank.

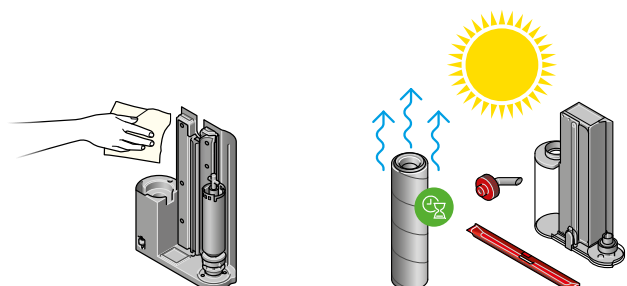

Looking after your machine

Replace the roller

To help maintain performance, we recommend you replace your PencilWash™ cleaner's microfibre roller every six months – depending on how often you use your machine.

Replacement rollers are available at [Dyson.co.uk](https://www.dyson.co.uk).

Battery and performance tips

Store your PencilWash™ wand on the dock and the cleaner head on its drip tray. Store the dock in a cool environment (<35°C) to best maintain battery health.

Always make sure there is water in the water tank while using the machine. Do not use the cleaner without any water.

Avoid storing the cleaner with a dirty tank and dirty roller – always empty and clean after use.

Use MAX mode for stubborn stains.

Best performance achieved with Dyson 02 Probiotic Cleaning Solution.

Disassembling your machine

Should you need to store or repackage your machine, detach the cleaner head and battery from the main body, as shown opposite.

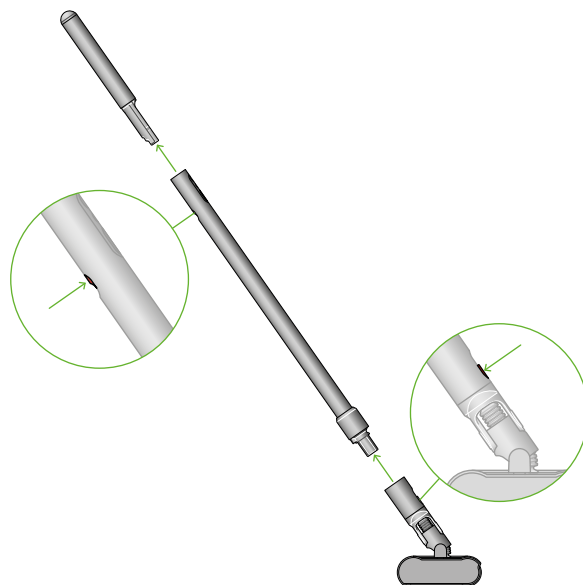

Support and service

Visit [dyson.co.uk/support](https://www.dyson.co.uk/support) for videos, tips, and spare parts ordering.

Contact Dyson Customer Care for assistance.