

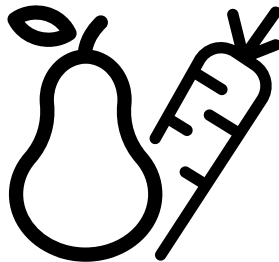

No-Frost Refrigerator Freezer

User manual



INK 21411 G4UK



EN



THANK YOU FOR BUYING A INDESIT PRODUCT

In order to receive a more complete assistance, please register your product on www.register10.eu



PLEASE SCAN THE QR CODE ON YOUR APPLIANCE IN ORDER TO REACH MORE INFORMATION

Dear Customer,

Please read this manual before using the product.

We would like you to achieve the optimal efficiency from this high quality product which has been manufactured with state of the art technology. To do this, carefully read this manual and any other documentation provided before using the product and keep it as a reference. Heed all information and warnings in the user manual. This way, you will protect yourself and your product against the dangers that may occur. Keep the user manual. Include this guide with the unit if you hand it over to someone else.

The following symbols are used in the user guide:

Hazard that may result in death or injury.

NOTICE: A hazard that may cause material damage to the product or its surroundings

Important information or useful tips on operation.

Read the user manual.

Please enter following websites docs.indesit.eu & parts-selfservice.europeanappliances.com

Information

The model's technical information can be retrieved by scanning the QR code on the Energy label and proceeding to the website entering the model identifier.

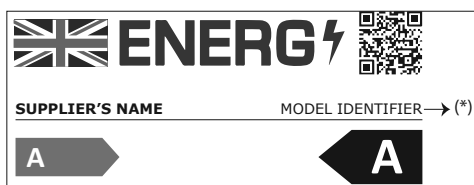
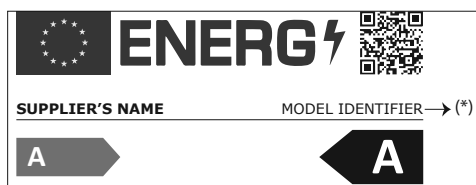

<u>1 Safety Instructions.....3</u>	<u>5 Preparation.....11</u>
⚠ 1.1. Purpose of usage.....3	5.1. Reversing the doors 12
⚠ 1.2. Safety of children, vulnerable persons and pets.....3	<u>6 Operating the product11</u>
⚠ 1.3. Electrical safety4	6.1. Storing into the fresh food compartment 14
⚠ 1.4. Handling Safety4	6.2. Storing into the freezer compartment . 15
⚠ 1.5. Installation Safety4	6.3. Changing the illumination lamp 16
⚠ 1.6. Operational safety.....5	6.4. Open door warning 16
⚠ 1.7. Maintenance and cleaning safety6	6.5. Crisper 16
⚠ 1.8. Lighting.....6	6.6. Freezing fresh food..... 16
<u>2 Environmental Instructions7</u>	6.7. Recommendations for storing frozen foods 17
<u>3 Your Refrigerator.....8</u>	6.8. Deep freezer details 17
<u>4 Installation9</u>	6.9. Placing the food 17
4.1. Appropriate Installation Location9	<u>7 Maintenance and cleaning.....18</u>
4.2. Adjusting the Feet9	<u>8 Troubleshooting19</u>
4.3. Electrical Connection 9	

1 Safety Instructions

- This section includes the safety instructions necessary to prevent the risk of personal injury or material damage.
- Our company shall not be held responsible for damages that may occur if these instructions are not observed.

⚠ Installation and repair operations shall always be performed by Authorized Service.

⚠ Always use genuine spare parts and accessories.

⚠ Original spare parts will be provided for 10 years, following the product purchasing date.

⚠ Do not repair or replace any part of the product unless specified expressly in the user manual.

⚠ Do not perform any modifications on the product.

⚠ 1.1. Purpose of usage

- This product is not intended for commercial use and it shall not be used out of its intended purpose.

This product is intended for operating interiors, such as households or similar. For example:

- In the staff kitchens of the stores, offices and other working environments,
- In farm houses,
- In the units of hotels, motels or other resting facilities that are used by the customers,
- In hostels, or similar environments,
- In catering services and similar non-retail applications.

This product shall not be used in open or enclosed external environments such as vessels, balconies or terraces. Exposing the product to rain, snow, sunlight and wind may cause risk of fire.

⚠ 1.2. Safety of children, vulnerable persons and pets

- This product may be used by children aged 8 years and older and persons with underdeveloped physical, sensory or mental capabilities or lack of experience and knowledge if they have been given supervision or instruction concerning use of the appliance in a the product safe way and the hazards involved.
- Children between 3 and 8 years are allowed to put and take out food to/from the cooler product.
- Electrical products are dangerous for children and pets. Children and pets must not play with, climb on, or enter the product.
- Cleaning and user maintenance should not be performed by children unless there is someone overseeing them.
- Keep the packaging materials away from children. Risk of injury and suffocation.

Before disposing of old products that shall not be used any more:

1. Unplug the power cord from the mains socket.
 2. Cut the power cord and remove it from the appliance together with the plug.
 3. Do not remove the racks and drawers from the product to prevent children from getting inside the appliance.
 4. Remove the doors.
 5. Store the product so that it shall not be tipped over.
 6. Do not allow children to play with the scrapped product.
- Do not dispose of the product by throwing it into fire. Risk of explosion.
 - If there is a lock available in the product's door, keep the key out of children's reach.

Safety Instructions

1.3. Electrical safety

- The product shall not be plugged into the outlet during installation, maintenance, cleaning, repair, and transportation operations.
- If the power the cord is damaged, it shall be replaced by authorized service only to avoid any risk that may occur.
- Do not tuck the power cord under the product or to the rear of the product. Do not put heavy items on the power cord. The power cord should not be bent, crushed, and come into contact with any heat source.
- Do not use an extension cord, multi- plug or adaptor to operate your product.
- Portable multi sockets or portable power supplies may overheat and cause fire. Thus, do not have a multi- plug behind or in the vicinity of the product.
- The plug shall be easily accessible. If this is not possible, a mechanism that meets the electrical legislation and that disconnects all terminals from the mains (fuse, switch, main switch, etc.) shall be available on the electrical installation.
- Do not touch the plug with wet hands.
- When unplugging the appliance, don't hold the power cord, but the plug.

1.4. Handling Safety

- This product is heavy, do not handle it by yourself.
- Do not hold the product from its door while handling the product.
- Be careful not to damage the cooling system and the pipes while handling the product. Do not operate the product if the pipes are damaged, and contact an authorized service.

1.5. Installation Safety

- Contact the Authorized Service for the product's installation. To prepare the product for installation, see the information in the user guide and make sure the electric and water utilities are as required. If the installation is not suitable, call a qualified electrician and plumber to have them make the necessary arrangements. Otherwise, electric shock, fire, issues with the product or injuries may occur.
- Check for any damage on the product before installing it. Do not have the product installed if it is damaged.
- Place the product on a level and hard surface and balance with the adjustable legs. Otherwise, the refrigerator may tip over and cause injuries.
- The product shall be installed in a dry and ventilated environment. Do not keep carpets, rugs or similar floor covers under the product. This may cause risk of fire as a result of inadequate ventilation!
- Do not block or cover ventilation holes. Otherwise, power consumption may be increased and damage to your product may occur.
- Do not connect the product to supply systems such as solar power supplies. Otherwise, damage to your product may occur as a result of the abrupt voltage fluctuations!
- The more refrigerant a refrigerator contains, the bigger its installation room shall be. In very small rooms, a flammable gas-air mixture may occur in case of a gas leak in the cooling system. At least 1 m³ of volume is required for each 8 grams of refrigerant. The amount of the refrigerant available in your product is specified in the Type Label.
- The installation place of the product shall not be exposed to direct sunlight and it shall not be in the vicinity of a heat source such as stoves, radiators, etc.

Safety Instructions

If you cannot prevent installation of the product in the vicinity of a heat source, you shall use a suitable insulation plate and the minimum distance to the heat source shall be as specified below.

- At least 30 cm away from heat sources such as stoves, heating units and heaters, etc.;
- And at least 5 cm away from electric ovens.
- Your product has the protection class of I. Plug the product in a grounded socket that conforms with the Voltage, Current and Frequency values specified in the type label. The socket outlet shall be equipped with a fuse with a rating of 10 A – 16 A. Our company shall not be responsible for the damages that shall be incurred as a result of operating the product without ensuring ground and electrical connections made as per local or national regulations.
- The product's power cable must be unplugged during installation. Otherwise, risk of electric shock and injury may occur!
- Do not plug the product to loose, broken, dirty, greasy sockets or sockets that has come out their seats or sockets with a risk of water contact.
- Place the power cord and hoses (if available) of the product so that they shall not cause a risk of tripping over.
- Penetration of humidity to live parts or to the power cord may cause short circuit. Thus, do not use the product in humid environments or in areas where water may splash (e.g. garage, laundry room, etc.) If the refrigerator is wet by water, unplug it and contact an authorized service.
- Do not connect your refrigerator to power saving devices. These systems are harmful for the product.
- In case of a failure of the product, unplug it and do not operate until it is repaired by the authorized service. There is a risk of electric shock!
- Do not place a source of flame (e.g. candles, cigarettes, etc.) on the product or in the vicinity of it.
- Do not get on the product. Risk of falling and injury!
- Do not cause damage to the pipes of the cooling system using sharp and piercing tools. The refrigerant that sprays out in case of puncturing the gas pipes, pipe extensions or upper surface coatings may cause irritation of skin and injuries of the eyes.
- Do not place and operate electric appliances inside the refrigerators / deep freezer unless it is advised by the manufacturer.
- Do not jam any parts of your hands or your body to the moving parts inside the product. Be careful to prevent jamming of your fingers between the refrigerator and its door. Be careful while opening or closing the door if there are children around.
- Do not put ice cream, ice cubes or frozen food to your mouth as soon as you take them out of the freezer. Risk of frostbite!
- Do not touch the inner walls, metal parts of the freezer or food kept inside the refrigerator with wet hands. Risk of frostbite!
- Do not place soda cans or cans and bottles that contain fluids that may be frozen to the freezer compartment. Cans or bottles may explode. Risk of injury and material damage!
- Do not use or place materials sensitive against temperature such as flammable sprays, flammable objects, dry ice or other chemical agents in the vicinity of the refrigerator. Risk of fire and explosion!
- Do not store explosive materials such as aerosol cans with flammable materials inside the product.



1.6. Operational safety

- Do not use chemical solvents on the product. These materials contain an explosion risk.

Safety Instructions

- Do not place cans containing fluids over the product. Splashing of water on an electrical part may cause the risk of an electric shock or a fire.
 - This product is not intended for storage and cooling of medicines, blood plasma, laboratory preparations or similar materials and products that are subject to the Medical Products Directive.
 - If the product is used against its intended purpose, it may cause damage to or deterioration of the products kept inside.
 - If your refrigerator is equipped with blue light, do not look at this light with optical devices. Do not stare directly at UV LED light for a long time. Ultraviolet rays may cause eye strain.
 - Do not fill the product with more food than its capacity. Injuries or damages may occur if the contents of the refrigerator falls when the door is opened. Similar problems may occur when an object is placed over the product.
 - Ensure that you have removed any ice or water that may have fallen to the floor to prevent injuries.
 - Change the locations of the racks / bottle racks on the door of your refrigerator while the racks are empty only. Danger of physical injury!
 - Do not place objects that may fall / tipped over on the product. These objects may fall while opening or closing the door and cause injuries and/or material damages.
 - Do not hit or exert excessive pressure on glass surfaces. Broken glass may cause injuries and / or material damages.
 - The cooling system in your product contains R600a refrigerant. The refrigerant type used in the product is specified in the the type label. This gas is flammable. Therefore, be careful not to damage the cooling system and the pipes while operating the product. In case of damage to the pipes:
 - Do not touch the product or the power cord,
 - Keep the product away from potential sources of fire that may cause the product to catch fire.
 - Ventilation the area where the product is placed. Do not use a fan.
 - Contact authorized service.
 - If the product is damaged and you observe gas leak, please stay away from the gas. Gas may cause frostbite if it contacts your skin.
- ## 1.7. Maintenance and cleaning safety
- Do not pull by the door handle if you shall move the product for cleaning purposes. Handle may cause injuries if it is pulled too hard.
 - Do not clean the product by spraying or pouring water on the product and inside the product. Risk of electric shock and fire.
 - Do not use sharp or abrasive tools to clean the product. Do not use materials such as household cleaning agents, detergents, gas, gasoline, alcohol, wax, etc.
 - Use cleaning and maintenance agents that are not harmful for food only inside the product.
 - Do not use steam or steamed cleaning materials for cleaning the product and thawing the ice inside it. Steam contacts the live areas in your refrigerator and causes short circuit or electric shock!
 - Take care to keep water away from the electronic circuits or lighting of the product.
 - Use a clean, dry cloth to wipe the dust or foreign material on the tips of the plugs. Do not use a wet or damp piece of cloth to clean the plug. Otherwise, risk of fire or electric shock may occur.
- ## 1.8. Lighting
- (May not be applicable for all models)**
- Contact an authorized service when you shall replace the LED/bulb using for lighting.

2 Environmental Instructions

2.1. Compliance with the WEEE Directive and Disposing of the Waste Product:

This product complies with EU WEEE Directive (2012/19/EU). This product bears a classification symbol for waste electrical and electronic equipment (WEEE).



This symbol indicates that this product shall not be disposed with other household wastes at the end of its service life.

Used device must be returned to official collection point for recycling of electrical and electronic devices. To find these collection systems please contact to your local authorities or retailer where the product was purchased. Each household performs important role in recovering and recycling of old appliance. Appropriate disposal of used appliance helps prevent potential negative consequences for the environment and human health.

2.2. Compliance with RoHS Directive

The product you have purchased complies with EU RoHS Directive (2011/65/EU). It does not contain harmful and prohibited materials specified in the Directive.

2.3. Package information



Packaging materials of the product are manufactured from recyclable materials in accordance with our National Environment Regulations.

Do not dispose of the packaging materials together with the domestic or other wastes. Take them to the packaging material collection points designated by the local authorities.

3 Your Refrigerator

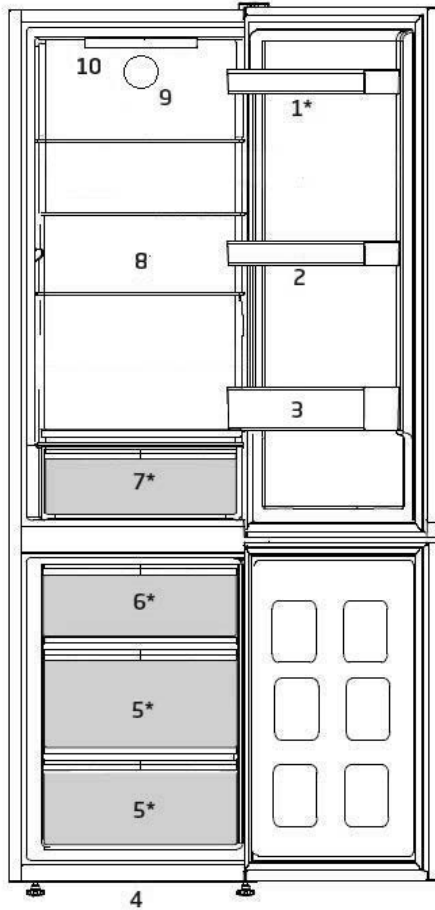

- | | |
|--------------------------|-----------------------------|
| 1. Egg tray | 6. Quick Freeze compartment |
| 2. Adjustable shelves | 7. Crisper |
| 3. Bottle shelf | 8. Adjustable shelves |
| 4. Adjustable front feet | 9. Fan |
| 5. Freezer compartment | 10. Illumination lamp |

*** May not be available in all models**





Figures that take place in this instruction manual are schematic and may not correspond exactly with your product. If the subject parts are not included in the product you have purchased, then it is valid for other models.

4 Installation

 Read the “Safety Instructions” section first!

4.1. Appropriate Installation Location

Contact an Authorized Service for the installation of the product. In order to prepare the product for use, refer the information in the user manual and ensure that electrical installation and water installation are appropriate. If not, call a qualified electrician and technician to have any necessary arrangements carried out.

	WARNING: Manufacturer shall not be held liable for damages that may arise from procedures carried out by unauthorized persons.
	WARNING: Product must not be plugged in during installation. Otherwise, there is the risk of death or serious injury!
	WARNING: If the door clearance of the room where the product shall be place is so tight to prevent passing of the product, remove the door of the room and pass the product through the door by turning it to its side; if this does not work, contact the authorized service.

- Place the product on an even floor surface to prevent jolts.
- Install the product at least 30 cm away from heat sources such as hobs, heater cores and stoves and at least 5 cm away from electrical ovens.
- Product must not be subjected to direct sun light and kept in humid places.
- Appropriate air ventilation must be provided around your product in order to achieve an efficient operation. If the product is to be placed in a recess in the wall, pay attention to leave at least 5 cm distance with the ceiling and side walls.



- Please provide at least 5cm distance for air circulation between the back side of your product and the wall to avoid condensation on the rear panel of product.
- Your product requires adequate air circulation to function efficiently. If the product will be placed in an alcove, remember to leave at least 5 cm clearance between the product and the ceiling, rear wall and the side walls.
- If the product will be placed in an alcove, remember to leave at least 5 cm clearance between the product and the ceiling, rear wall and the side walls. Check if the rear wall clearance protection component is present at its location (if provided with the product). If the component is not available, or if it is lost or fallen, position the product so that at least 5 cm clearance shall be left between the rear surface of the product and the wall of the room. The clearance at the rear is important for efficient operation of the product.

4.2. Adjusting the Feet

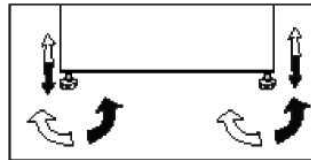
If the product stands unbalanced after installation, adjust the feet on the front by rotating them to the right or left.



4.3. Elektrische aansluiting

	WARNING: Do not make connections via extension cables or multi-plugs.
	WARNING: Damaged power cable must be replaced by the Authorized Service Agent.

Installation



If two coolers are to be installed side by side, there should be at least 4 cm distance between them.

- Our company shall not be liable for any damages that will arise when the product is used without grounding and electrical connection in accordance with the national regulations.
- Power cable plug must be within easy reach after installation.
- Do not extension cords or cordless multiple outlets between your product and the wall outlet.



Hot Surface Warning!

Side walls of your product is equipped with refrigerant pipes to improve the cooling system. Refrigerant with high temperatures may flow through these areas, resulting in hot surfaces on the side walls. This is normal and does not need any servicing. Please pay attention while touching these areas.

5 Preparation

 Read the “Safety Instructions” section first!

- For a freestanding appliance; this refrigerating appliance is not intended to be used as a built-in appliance.
- Your refrigerator should be installed at least 30 cm away from heat sources such as hobs, ovens, central heater and stoves and at least 5 cm away from electrical ovens and should not be located under direct sunlight.
- The ambient temperature of the room where you install your refrigerator should at least be +5°C. Operating your refrigerator under cooler conditions is not recommended with regard to its efficiency.
- Please make sure that the interior of your refrigerator is cleaned thoroughly.
- If two refrigerators are to be installed side by side, there should be at least 2 cm distance between them.
- When you operate your refrigerator for the first time, please observe the following instructions during the initial six hours.
- The door should not be opened frequently.
- It must be operated empty without any food in it.
- Do not unplug your refrigerator. If a power failure occurs out of your control, please see the warnings in the “Recommended solutions for the problems” section.
- Original packaging and foam materials should be kept for future transportations or moving.
- The baskets / drawers that are provided with the chill compartment must always be in use for low energy consumption and for better storage conditions.
- Food contact with the temperature sensor in the freezer compartment may increase energy consumption of the appliance. Thus any contact with the sensor(s) must be avoided.
- In some models, the instrument panel automatically turns off 1 minutes after the door has closed. It will be reactivated when the door has opened or pressed on any key.
- Due to temperature change as a result of opening / closing the product door during operation, condensation on the door/body shelves and the glass containers is normal.
- Since hot and humid air will not directly penetrate into your product when the doors are not opened, your product will optimize itself in conditions sufficient to protect your food. Functions and components such as compressor, fan, heater, defrost, lighting, display and so on will operate according to the needs to consume minimum energy under these circumstances.
- In case of multiple options are present glass shelves must be placed so that the air outlets at the backwall are not blocked, preferably air outlets are remaining below the glass shelf. This combination may help improving air distribution and energy efficiency.

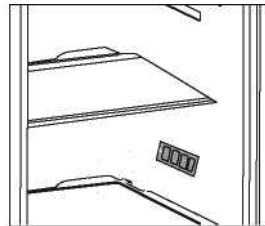

Preparation

5.1. Reversing the doors

Proceed in numerical order.

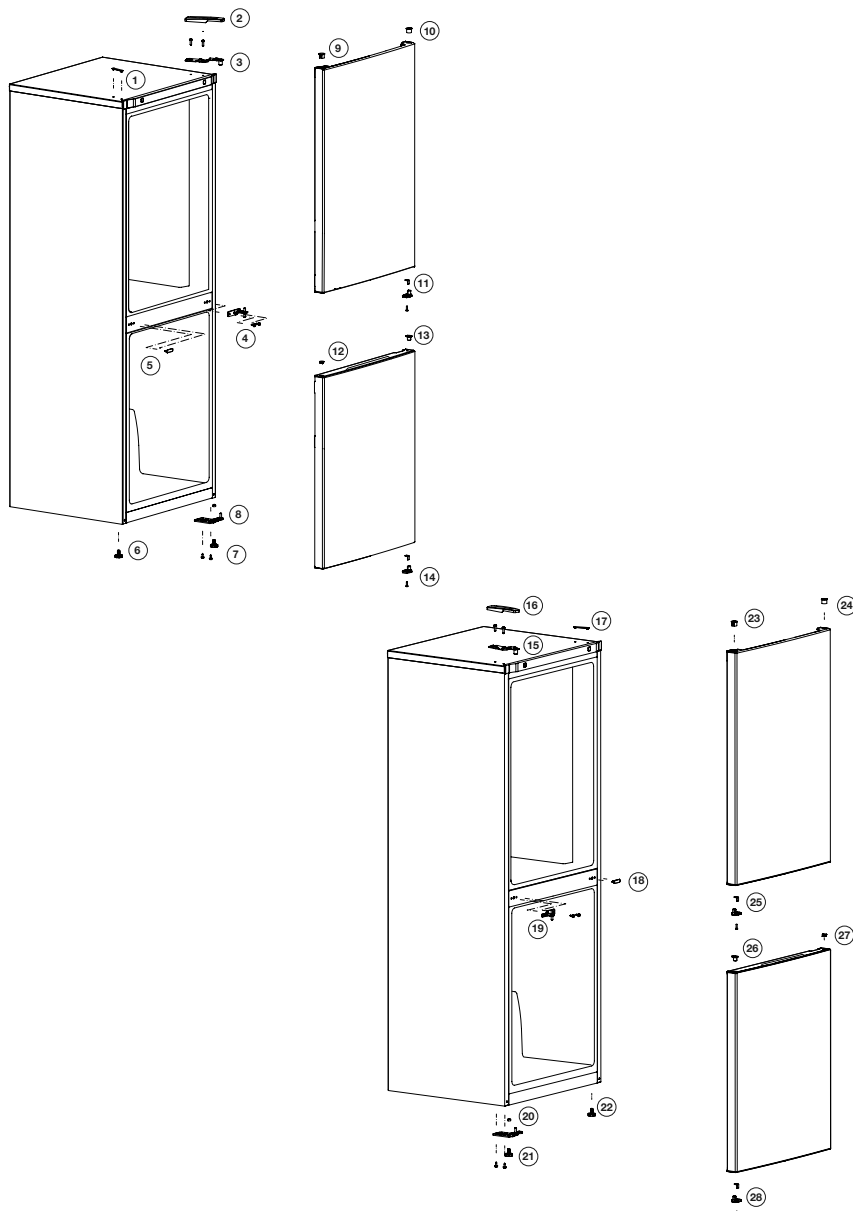

6 Operating the product

 Read the "Safety Instructions" section first!

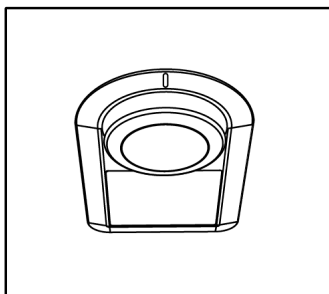

The operating temperature is regulated by the temperature control.



**Min. = Lowest cooling setting
(Warmest setting)**

**Max. = Highest cooling setting
(Coldest setting)**

The average temperature inside the fridge should be around +5°C.

Please choose the setting according to the desired temperature.

Please note that there will be different temperatures in the cooling area.

The coldest region is immediately above the vegetable compartment.

The interior temperature also depends on ambient temperature, the frequency with which the door is opened and the amount of foods kept inside.

Frequently opening the door causes the interior temperature to rise.

For this reason, it is recommended to close the door again as soon as possible after use.

Thermostat setting button

The interior temperature of your refrigerator changes for the following reasons:

- Seasonal temperatures;
- Frequent opening of the door and leaving the door open for long periods;
- Food put into the refrigerator without cooling down to the room temperature;
- The location of the refrigerator in the room (e.g. exposing to sunlight);
- You may adjust the varying interior temperature due to such reasons by using the thermostat. Numbers around the thermostat button indicates the cooling degrees;
- If the ambient temperature is higher than 32°C, turn the thermostat button to maximum position;
- If the ambient temperature is lower than 25°C, turn the thermostat button to minimum position;

Defrost

Fridge compartment performs full automatic defrosting. Water drops and a frosting up to 7-8 mm can occur on the inner rear wall of the fridge compartment while your refrigerator cools down. Such formation is normal as a result of the cooling system. The frost formation is defrosted by performing automatic defrosting with certain intervals thanks to the automatic defrosting system of the rear wall. User is not required to scrape the frost or remove the water drops.

Water resulting from the defrosting passes from the water collection groove and flows into the evaporator through the drain pipe and evaporates here by itself.

Deep freezer compartment does not perform automatic defrosting in order to prevent decaying of the frozen food. The freezer compartment defrosts automatically.

Operating the product

6.1. Storing into the fresh food compartment

- Keep your fridge at recommended temperature level as 4°C.
- Food to be stored should be properly sealed to avoid odour or taste alterations.
- Do not store excessive quantities of food inside your refrigerator. Leave spaces between foods to allow cold air flowing around them to achieve a better and more homogeneous cooling.
- To allow shorter door openings, foods eaten daily should be stored at the front of the shelf.
- Leave a gap between foods and the inner walls, allowing air to flow. If you store foods against the rear wall foods could freeze against rear wall.
- Hot, cooked food must be cooled down at room temperature before storing in the appliance. Then, warm food can be stored in the lower shelves of your fridge. Please do not put warm food nearby highly perishable foods.
- Onions, garlic, ginger and other root vegetables should be stored at dark and cool room conditions, not in the fridge.
- If unripe tropical fruits (mango, melons, papaya, banana, pineapple) are stored in refrigerator, ageing process can be accelerated and it is not advisable since it causes shorter storage times. However, the ripening of strongly green fruits (apple, pear) can be promoted for a certain period in fridge compartment.
- When a spoiled food inside refrigerator is realized, it should be disposed. When rotten food is noticed, please clean inner liner or accessories which were in contact to prevent contamination.
- Thaw your frozen food in the fresh food compartment. This way, you can use the frozen food to cool down the fresh food compartment and save energy.
- Large pots of food, such as soups or stews can be divided into shallow containers to quickly cool in the refrigerator. Large pieces of cooked meat and whole poultry should be divided into smaller pieces for the same purpose.
- Do not store unpacked foods nearby eggs.
- Keep fruits and vegetables separate and store like with like: apples with apples, carrots with carrots. Fruits and vegetables give off different gases that can cause others to deteriorate.
- Take leafy greens out of plastic bags, wrap them in a paper towel or tea towel before stored in refrigerator. Do not forget to dry them if they are rinsed or wet before storing.
- Store fruits and vegetables susceptible to drying out in perforated or unsealed plastic bags to maintain a moist environment yet still allow air to circulate.
- Different foods should be placed in different areas according to their properties:

Please check appropriate Climate Class of your appliance rated on the rating plate. One of below information is valid for your appliance according to rated Climate Class.

- **SN** : Extended Temperate: This refrigerating appliance is intended to be used at ambient temperatures ranging from 10°C to 32°C.
- **N** : Temperate: This refrigerating appliance is intended to be used at ambient temperatures ranging from 16°C to 32°C.

Operating the product

- **ST** : Subtropical: This refrigerating appliance is intended to be used at ambient temperatures ranging from 16°C to 38°C.
- **T** : Tropical: This refrigerating appliance is intended to be used at ambient temperatures ranging from 16°C to 43°C.

Food	Location
Eggs	Door rack
Dairy products (butter, cheese)	If available, biofresh or chiller compartment Lowest shelves.
Fruits, vegetables and salad	Fruit and vegetable box, crisper or EverFresh+ compartment (if available)
Fresh meat, poultry, fresh fish, sausages, cooked foods	If available, biofresh or chiller compartment Lowest shelf
Ready to eat foods, packaged products, canned foods, pickled products	Upper shelves or door rack
Drinks, bottles, condiments, snacks	Door rack
Leftovers	Middle shelves

6.2. Storing into the freezer compartment

- It is recommended to keep freezer setting at -18°C except extreme ambient conditions.
- 8 hours before freezing switch on the Fast Freeze function to provide faster freezing.
- Hot food must be cooled to room temperature before storing in the freezer compartment.
- Food cut into small portions will freeze faster and be easier to defrost and cook.
- It is better to pack food before putting it into the freezer.
- In order to avoid expiry of storage periods, please note the freezing date, time limit and name of the food on the packaging according to the storage periods of different foods.
- Consume defrosted food quickly. Defrosted food cannot be re-frozen unless it is cooked. It is not safe to consume uncooked re-frozen fresh food.

- Do not exceed the food storage times recommended by the food manufacturers. Only take the required amount of food out of the freezer.
- When freezing fresh food, avoid bringing it in contact with already frozen food. It may cause thawing of already frozen pieces.

When storing commercially frozen foods, please follow these guidelines:

Always follow manufacturers' guidelines for the length of time you should store the food for. Do not exceed these guidelines!

- Try to keep the length of time between purchase and storage as short as possible to preserve food quality.
- Buy frozen foods, which have been stored at a temperature of -18°C or below.
- Avoid buying food which has ice or frost on the packaging – This indicates that the products might have been partially defrosted and refrozen at some point – temperature rises affect the quality of food.

Operating the product

- We recommend a temperature setting of +4°C for fresh food compartment and -18°C for freezer compartment to achieve better food preservation.
- With the exception of extreme conditions in ambient, if temperature is set to recommended values as +4°C / -18°C, overall freshness will be prolonged within fresh food and freezer compartments. If temperature of fresh food compartment is set to cooler, fresh fruits and vegetables may be partially frozen or exposed to cold injury, while warmer temperature level may cause faster spoilage of highly perishable foods (dairy products, meat products).

6.3. Changing the illumination lamp

To change the Bulb / LED used for illumination of your refrigerator, call your AuthorisedService.

The lamp(s) used in this appliance is not suitable for household room illumination. The intended purpose of this lamp is to assist the user to place foodstuffs in the refrigerator / freezer in a safe and comfortable way.

The lamps used in this appliance have to withstand extreme physical conditions such as temperatures below -20 °C.

6.4. Open door warning

An audio warning will be given when the fridge or freezer compartment door of your product is left open for a certain period of time. This audio warning signal will mute when any button on the indicator is pressed or when the door is closed.

6.5. Crisper

The refrigerator's crisper is designed to keep vegetables fresh by preserving their humidity. For this purpose, the overall cold air circulation is intensified in the crisper. Keep fruits and vegetables in this compartment. Keep the green-leaved vegetables and fruits separately to prolong their life.

6.6. Freezing fresh food

- 8 hours before freezing the fresh food activate the Quick Freeze function.
- To preserve food quality, the food items placed in the freezer compartment must be frozen as quickly as possible, use the rapid freezing for this.
- Freezing the food items when fresh will extend the storage time in the freezer compartment.
- Pack the food items in air-tight packs and seal tightly.
- Make sure the food items are packed before putting in the freezer. Use freezer holders, tinfoil and damp-proof paper, plastic bag or similar packaging materials instead of traditional packaging paper.



Ice in the freezing compartment thaws automatically.

- Mark each food pack by writing the date on the package before freezing. This will allow you to determine the freshness of each pack every time the freezer is opened. Keep the earlier food items in the front to ensure they are used first.
- Frozen food items must be used immediately after defrosting and should not be frozen again.
- Do not free large quantities of food at once.

Operating the product

Freezer Compartment Temperature Setting	Cooler Compartment Temperature Setting	Details
-18°C	4°C	This is the default, recommended setting.
-20°C,-22°C or -24°C	4°C	These settings are recommended for ambient temperatures exceeding 30°C.
Quick Freeze	4°C	Use when you want to freeze your food in a short time. When the process ends, the product will regain its position.
-18°C or colder	2°C	Use these settings if you believe the cooler compartment is not cold enough due to ambient temperature or frequently opening the door.

6.7. Recommendations for storing frozen foods

The compartment must be set to at least -18°C.

1. Place the food items in the freezer as quickly as possible to avoid defrosting.
2. Before freezing, check the “Expiry Date” on the package to make sure it is not expired.
3. Make sure the food’s packaging is not damaged.

6.8. Deep freezer details

As per the IEC 62552 standards, the freezer must have the capacity to freeze 4,5 kg of food items at -18°C or lower temperatures in 24 hours for each 100 litres of freezer compartment volume.

Food items can only be preserved for extended periods at or below temperature of - 18°C. You can keep the foods fresh for months (in deep freezer at or below temperatures of -18°C).

The food items to be frozen must not contact the already-frozen food inside to avoid partial defrosting.















Boil the vegetables and filter the water to extend the frozen storage time. Place the food in air-tight packages after filtering and place in the freezer.

Bananas, tomatoes, lettuce, celery, boiled eggs, potatoes and similar food items should not be frozen. In case this food rots, only nutritional values and eating qualities will be negatively affected. A rotting threatening human health is not in question.

6.9. Placing the food

Freezer compartment shelves	Various frozen goods including meat, fish, ice cream, vegetables etc.
Cooler compartment shelves	Food items inside pots, capped plate and capped cases, eggs (in capped case)
Cooler compartment door shelves	Small and packed food or beverages
Vegetable bin	Fruits and vegetables
Fresh food compartment	Delicatessen (breakfast food, meat products to be consumed in short notice)

7 Maintenance and cleaning

-  Read the “Safety Instructions” section first!
-  Never use gasoline, benzene or similar substances for cleaning purposes.
-  We recommend that you unplug the appliance before cleaning.
-  Never use any sharp abrasive instrument, soap, household cleaner, detergent and wax polish for cleaning.
-  For non-No Frost products, water drops and frosting up to a fingerbreadth occur on the rear wall of the Fridge compartment. Do not clean it; never apply oil or similar agents on it.
-  Only use slightly damp microfiber cloths to clean the outer surface of the product. Sponges and other types of cleaning cloths may scratch the surface.
-  Use lukewarm water to clean the cabinet of your refrigerator and wipe it dry.
-  Use a damp cloth wrung out in a solution of one teaspoon of bicarbonate of soda to one pint of water to clean the interior and wipe it dry.
-  Make sure that no water enters the lamp housing and other electrical items.
-  If your refrigerator is not going to be used for a long period of time, unplug the power cable, remove all food, clean it and leave the door ajar.
-  Check door seals regularly to ensure they are clean and free from food particles.
-  To remove door racks, remove all the contents and then simply push the door rack upwards from the base.
-  Never use cleaning agents or water that contain chlorine to clean the outer surfaces and chromium coated parts of the product. Chlorine causes corrosion on such metal surfaces.
-  Do not use sharp, abrasive tools, soap, household cleaning agents, detergents, kerosene, fuel oil, varnish etc. to prevent removal and deformation of the prints on the plastic part. Use lukewarm water and a soft cloth for cleaning and then wipe it dry.

Protection of plastic surfaces

-  Do not put the liquid oils or oil- cooked meals in your refrigerator in unsealed containers as they damage the plastic surfaces of your refrigerator. In case of spilling or smearing oil on the plastic surfaces, clean and rinse the relevant part of the surface at once with warm water.

8 Troubleshooting

Please review this list before calling the service. It will save your time and money. This list includes frequent complaints that are not arising from defective workmanship or material usage. Some of the features described here may not exist in your product.

The refrigerator does not operate.

- The plug is not inserted into the socket correctly. >>> Insert the plug into the socket securely.
- The fuse of the socket which your refrigerator is connected to or the main fuse have blown out. >>> Check the fuse.

Condensation on the side wall of the fridge compartment (MULTIZONE, COOL CONTROL and FLEXI ZONE).

- Door has been opened frequently. >>> Do not open and close the door of refrigerator frequently.
- Ambient is very humid. >>> Do not install your refrigerator into highly humid places.
- Food containing liquid is stored in open containers. >>> Do not store food with liquid content in open containers.
- Door of the refrigerator is left ajar. >>> Close the door of the refrigerator.
- Thermostat is set to a very cold level. >>> Set the thermostat to a suitable level.

Compressor is not running

- Protective thermic of the compressor will blow out during sudden power failures or plug-out plug-ins as the refrigerant pressure in the cooling system of the refrigerator has not been balanced yet. The refrigerator will start running approximately after 6 minutes. Please call the service if the refrigerator does not startup at the end of this period.
- The fridge is in defrost cycle. >>> This is normal for a full-automatically defrosting refrigerator. Defrosting cycle occurs periodically.
- The refrigerator is not plugged into the socket. >>> Make sure that the plug is fit into the socket.

- Temperature settings are not made correctly >>> Select the suitable temperature value.
- There is a power outage. >>> Refrigerator returns to normal operation when the power restores.

The operation noise increases when the refrigerator is running.

- The operating performance of the refrigerator may change due to the changes in the ambient temperature. It is normal and not a fault.

The refrigerator is running frequently or for a long time.

- New product may be wider than the previous one. Larger refrigerators operate for a longer period of time.
- The room temperature may be high. >>> It is normal that the product operates for longer periods in hot ambient.
- The refrigerator might be plugged in recently or might be loaded with food. >>> When the refrigerator is plugged in or loaded with food recently, it will take longer for it to attain the set temperature. This is normal.
- Large amounts of hot food might be put in the refrigerator recently. >>> Do not put hot food into the refrigerator.
- Doors might be opened frequently or left ajar for a long time. >>> The warm air that has entered into the refrigerator causes the refrigerator to run for longer periods. Do not open the doors frequently.
- Freezer or fridge compartment door might be left ajar. >>> Check if the doors are closed completely.
- The refrigerator is adjusted to a very low temperature. >>> Adjust the refrigerator temperature to a warmer degree and wait until the temperature is achieved.
- Door seal of the fridge or freezer may be soiled, worn out, broken or not properly seated. >>> Clean or replace the seal. Damaged/broken seal causes the refrigerator to run for a longer period of time in order to maintain the current temperature.

Troubleshooting

Freezer temperature is very low while the fridge temperature is sufficient.

- The freezer temperature is adjusted to a very low value. >>> Adjust the freezer temperature to a warmer degree and check.

Fridge temperature is very low while the freezer temperature is sufficient.

- The fridge temperature is adjusted to a very low value. >>> Adjust the fridge temperature to a warmer degree and check.

Food kept in the fridge compartment drawers is frozen.

- The fridge temperature is adjusted to a very high value. >>> Adjust the fridge temperature to a lower value and check.

Temperature in the fridge or freezer is very low.

- The fridge temperature is adjusted to a very high value. >>> Fridge compartment temperature setting has an effect on the temperature of the freezer. Change the temperatures of the fridge or freezer and wait until the relevant compartments attain a sufficient temperature.
- Doors are opened frequently or left ajar for a long time. >>> Do not open the doors frequently.
- Door is ajar. >>> Close the door completely.
- The refrigerator is plugged in or loaded with food recently. >>> This is normal. When the refrigerator is plugged in or loaded with food recently, it will take longer for it to attain the set temperature.
- Large amounts of hot food might be put in the refrigerator recently. >>> Do not put hot food into the refrigerator.

Vibrations or noise.

- The floor is not level or stable. >>> If the refrigerator rocks when moved slowly, balance it by adjusting its feet. Also make sure that the floor is strong enough to carry the refrigerator, and level.
- The items put onto the refrigerator may cause noise. >>> Remove the items on top of the refrigerator.

There are noises coming from the refrigerator like liquid flowing, spraying, etc.

- Liquid and gas flows occur in accordance with the operating principles of your refrigerator. It is normal and not a fault.

Whistle comes from the refrigerator.

- Fans are used in order to cool the refrigerator. It is normal and not a fault.

Condensation on the inner walls of refrigerator.

- Hot and humid weather increases icing and condensation. It is normal and not a fault.
- Doors are opened frequently or left ajar for a long time. >>> Do not open the doors frequently. Close them if they are open.
- Door is ajar. >>> Close the door completely.

Humidity occurs on the outside of the refrigerator or between the doors.

- There might be humidity in the air; this is quite normal in humid weather. When the humidity is less, condensation will disappear.

Bad odour inside the refrigerator.

- No regular cleaning is performed. >>> Clean the inside of the refrigerator regularly with a sponge, lukewarm water or carbonate dissolved in water.
- Some containers or package materials may cause the smell. >>> Use a different container or different brand packaging material.
- Food is put into the refrigerator in uncovered containers. >>> Keep the food in closed containers. Microorganisms spreading out from uncovered containers can cause unpleasant odours.
- Remove the foods that have expired best before dates and spoiled from the refrigerator.

The door is not closing.

- Food packages are preventing the door from closing. >>> Replace the packages that are obstructing the door.
- The refrigerator is not completely even on the floor. >>> Adjust the feet to balance the refrigerator.

Troubleshooting

- The floor is not level or strong. >>> Make sure that the floor is level and capable to carry the refrigerator.

Crispers are stuck.

- The food is touching the ceiling of the drawer. >>> Rearrange food in the drawer.

If The Surface Of The Product Is Hot.

- High temperatures may be observed between the two doors, on the side panels and at the rear grill while the product is operating. This is normal and does not require service maintenance!

DISCLAIMER / WARNING

Some (simple) failures can be adequately handled by the end-user without any safety issue or unsafe use arising, provided that they are carried out within the limits and in accordance with the following instructions (see the “Self-Repair” section).

Therefore, unless otherwise authorized in the “Self-Repair” section below, repairs shall be addressed to registered professional repairers in order to avoid safety issues. A registered professional repairer is a professional repairer that has been granted access to the instructions and spare parts list of this product by the manufacturer according to the methods described in legislative acts pursuant to Directive 2009/125/EC.

However, only the service agent (i.e. authorized professional repairers) that you can reach through the phone number given in the user manual/warranty card or through your authorized dealer may provide service under the guarantee terms. Therefore, please be advised that repairs by professional repairers (who are not authorized by manufacturer/seller) shall void the guarantee.

Self-Repair

Self-repair can be done by the end-user with regard to the following spare parts: door handles, door hinges, trays, baskets and door gaskets (an updated list is also available in Web as of 1st March 2021).

Moreover, to ensure product safety and to prevent risk of serious injury, the mentioned self-repair shall be done following the instructions in the user manual for self-repair or which are available in Web.

For your safety, unplug the product before attempting any self-repair.

Repair and repair attempts by end-users for parts not included in such list and/ or not following the instructions in the user manuals for self-repair or which are available in Web, might give raise to safety issues not attributable to manufacturer / seller, and will void the warranty of the product.

Therefore, it is highly recommended that end-users refrain from the attempt to carry out repairs falling outside the mentioned list of spare parts, contacting in such cases authorized professional repairers or registered professional repairers. On the contrary, such attempts by end-users may cause safety issues and damage the product and subsequently cause fire, flood, electrocution and serious personal injury to occur.

By way of example, but not limited to, the following repairs must be addressed to authorized professional repairers or registered professional repairers: compressor, cooling circuit, main board, inverter board, display board, etc.

The manufacturer / seller cannot be held liable in any case where end-users do not comply with the above.

This product is equipped with a lighting source of the «G» energy class.

The lighting source in this product shall only be replaced by professional repairers.

