

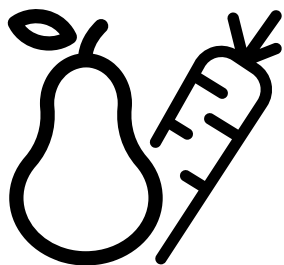

## Refrigerator - Freezer

User manual



**INKS 1361 W4UK**



EN





## THANK YOU FOR BUYING A INDESIT PRODUCT

In order to receive a more complete assistance, please register your product on [www.register10.eu](http://www.register10.eu)



## PLEASE SCAN THE QR CODE ON YOUR APPLIANCE IN ORDER TO REACH MORE INFORMATION

### Please read these instructions first before using your appliance

Please take some time to read this user manual before using your appliance, to ensure you know how to safely operate the controls and functions. Carefully follow all unpacking and installation instructions to ensure the appliance is correctly connected and fitted prior to use.

Please write your product model and serial number on the last page of this user manual, and store in a safe location close to the appliance for easy future reference. This user manual may also be applicable for several other models. Differences between models will be listed.

If you have any questions or concerns, please call our Customer Service Team or find help and information online on the Web.

### Explanation of symbols used throughout this User Manual



- The terminal in the plug is marked with the symbol.



- The freezer compartment is marked with the symbol.



- Important information or useful usage tips.



- Symbol for waste electrical and electronic equipment.



- Symbol for Packaging information.

MORE INFORMATION ON [docs.indesit.eu](http://docs.indesit.eu)  
& [parts-selfservice.europeanappliances.com](http://parts-selfservice.europeanappliances.com)

### Information

The model's technical information can be retrieved by scanning the QR code on the Energy label and proceeding to the website entering the model identifier.

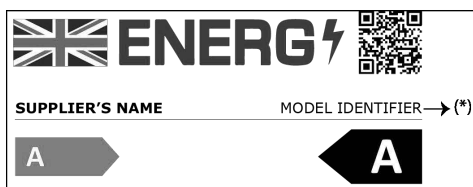
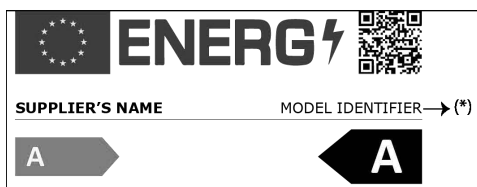

<b>CONTENTS</b>	<b>PAGE</b>
INTRODUCTION & SAFETY WARNINGS .....	3
ELECTRICAL REQUIREMENTS .....	5
TRANSPORTATION INSTRUCTIONS .....	6
INSTALLATION INSTRUCTIONS .....	6
GETTING TO KNOW YOUR FRIDGE FREEZER .....	8
REVERSING THE DOORS .....	9
SUGGESTED ARRANGEMENT OF FOOD IN THE FRIDGE FREEZE .....	10
Guidance for storing fresh food .....	11
TEMPERATURE CONTROL AND ADJUSTMENT .....	13
BEFORE OPERATING .....	14
STORING FROZEN FOOD .....	14
FREEZING FRESH FOOD .....	15
MAKING ICE CUBES .....	15
CRISPER .....	15
DEFROSTING .....	15
REPLACING THE INTERIOR LIGHT BULB .....	17
CLEANING AND CARE .....	17
DO'S AND DON'TS .....	18
ENERGY SAVING TIPS .....	19
PROBLEM SOLVING .....	20
DISCLAIMER / WARNING .....	21



## **WARNING!**

In order to ensure a normal operation of your refrigerating appliance, which uses a completely environmentally friendly refrigerant the **R600a** (flammable only under certain conditions) you must observe the following rules:

- Do not hinder the free circulation of the air around the appliance.
- Do not use mechanical devices in order to accelerate the defrosting, others than the ones recommended by the manufacturer.
- Do not destroy the refrigerating circuit.
- Do not use electric appliances inside the food keeping compartment, other than those that might have been recommended by the manufacturer.

## **WARNING!**

## **IMPORTANT!**

DO NOT connect your appliance to the electricity supply until all packing and transit protectors have been removed.

- Leave to stand for at least 4 hours before switching on to allow compressor oil to settle if transported horizontally.
- If you are discarding an old refrigerator with a lock or latch fitted to the door, disable the lock / latch, ensure that it is left in a safe condition to prevent the entrapment of children.
- This fridge/freezer must only be used for its intended purpose i.e. the storing of edible foodstuff.
- Do not dispose of the appliance on a fire. At INDESIT, the care and protection of our environment is an ongoing commitment. This appliance which is among the latest range introduced is particularly environment friendly. Your appliance contains non-CFC / HFC natural substances in the cooling system (Called R600a) and in the insulation (Called cyclopentane) which are potentially flammable if exposed to fire. Therefore, take care not to damage, the cooling circuit / pipes of the appliance in transportation and in use. In case of a damage do not expose the appliance to fire, potential ignition source and immediately ventilate the room where the appliance is situated.
- We suggest you contact your local authority for disposal information and facilities available.
- We do not recommend use of this appliance in an unheated, cold room. (E.g.: garage, conservatory, annex, shed, out-house etc.) See Installation Instructions on page 5 for further information.
- To obtain the best possible performance and trouble-free operation from your appliance it is very important to carefully read these instructions.
- On delivery, check to make sure that the product is not damaged and that all the parts and accessories are in perfect condition.
- Ensure that the plug remains readily accessible.
- We do not recommend the use of extension leads and multi-way adapters.
- Failure to observe these instructions may invalidate your right to free service during the guarantee period.

**WARNING!** -Do not use electrical appliances inside the food storage compartments of the appliance, unless they are of the type recommended by the manufacturer.

**WARNING!** - Do not use mechanical devices or other means to accelerate the defrosting process, other than those recommended by the manufacturer.

**WARNING!** - Do not damage the refrigerant circuit.

**WARNING!** - Do not use electrical appliances inside the food storage compartments of the appliance, unless they are of the type recommended by the manufacturer.

### Recycling

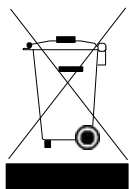

This product bears the selective sorting symbol for waste electrical and electronic equipment (WEEE). This means that this product must be handled pursuant to European Directive 2012/19/EU in order to be recycled or dismantled to minimize its impact on the environment. For further information, please contact your local or regional authorities. Electronic products not included in the selective sorting process are potentially dangerous for the environment and human health due to the presence of hazardous substances.

### Compliance with RoHS Directive

The product you have purchased complies with EU RoHS Directive (2011/65/EU). It does not contain harmful and prohibited materials specified in the Directive.

### Packaging information



Packaging materials of the product are manufactured from recyclable materials in accordance with our National Environment Regulations.

Do not dispose of the packaging materials together with the domestic or other wastes. Take them to the packaging material collection points designated by the local authorities.



This product is equipped with a lighting source of the "G" energy class. The lighting source in this product shall only be replaced by professional repairers.

## **ELECTRICAL REQUIREMENTS**

Before you insert the plug into the wall socket make sure that the voltage and the frequency shown in the rating plate inside the appliance corresponds to your electricity supply. Rating label is on the left-hand side of fridge inner liner.

**WARNING!** - When positioning the appliance ensure the supply cord is not trapped or damaged. We recommend that this appliance is connected to the mains supply via a suitable switched and fused socket in a readily accessible position. Should the mains lead of the appliance become damaged or should it need replacing at any time, it must be replaced by a special purpose made mains lead which can only be obtained from a **INDESIT** Authorised Service Agent.

### **WARNING! THIS APPLIANCE MUST BE EARTHED**

If the fitted moulded plug is not suitable for your socket, then the plug should be cut off and an appropriate plug fitted. Destroy the old plug which is cut off as a plug with bared cord could cause a shock hazard if inserted into a socket elsewhere in the house. The moulded plug on this appliance incorporates a 13 A fuse. Should the fuse need to be replaced an ASTA approved BS 1362 fuse of the same rating must be used. Do not forget to refit the fuse cover. In the event of losing the fuse cover the plug must not be used until a replacement fuse cover has been fitted. Colour of the replacement fuse cover must be the same colour as that visible on the pin face of the plug. Fuse covers are available from any good electrical store.

**WARNING!** - Do not locate extension sockets or charging transformers/power supplies or Lithium-Iron battery operated products adjacent to the compressor as they could overheat.

## TRANSPORTATION INSTRUCTIONS

1. The appliance should be transported only in an upright position. The packing as supplied must be intact during transportation.
2. If transported horizontally, leave to stand upright for at least **4** hours before switching on, to allow compressor oil to settle.
3. Failure to comply with the above instructions could result in damage to the appliance, for which the manufacturer will not be held liable.
4. The appliance must be protected against rain, moisture and other atmospheric influences.
5. When positioning your appliance take care not to damage your flooring, pipes, wall coverings etc. Do not move the appliance by pulling by the door or handle.
6. Empty any water in the drain tray before moving. See section **“DEFROSTING”** and **“CLEANING AND CARE”** for further information.
7. Make sure that the defrost water pipe at the back of the product is fixed to the plastic evaporating pan on the top of the compressor, to avoid defrost water spillage on the floor.

### Important!

- Care must be taken while cleaning/carrying the appliance not to touch the bottom of the condenser metal wires at the back of the appliance, as this could cause injury to fingers and hands.
- Do not attempt to sit or stand on top of your appliance as it is not designed for such use. You could injure yourself or damage the appliance.
- Make sure that the mains cable is not caught under the appliance during and after moving, as this could damage the cable.
- Do not allow children to play with the appliance or tamper with the controls. INDESIT declines to accept any liability should the instructions not be followed.

## INSTALLATION INSTRUCTIONS

1. The space in the room where the appliance is installed must not be smaller than 10 cubic metres.
2. Do not put your fridge freezer in a cold room where the temperature is likely to go below +10 °C (50 °F) during night-time and/or especially in winter. This fridge freezer has been designed to operate in ambient temperatures between +10 and +38 °C (50 and 100 °F). Therefore, if the appliance is installed in an unheated/cold room (e.g.: conservatory / annex / shed / garage etc.) then the appliance will not operate causing the freezer compartment to run warmer and as a result the storage time of frozen food may be reduced.

3. Do not place the appliance near cookers, radiators or in direct sunlight as this will cause your appliance to work harder. If installed next to a source of heat or freezer, maintain the following minimum side clearances:

From Cookers	2" (50 mm)
From Radiators	12" (300 mm)
From Refrigerators or Larder Fridge	1" (25 mm)

4. Make sure that sufficient room is provided around the appliance to ensure free air circulation:

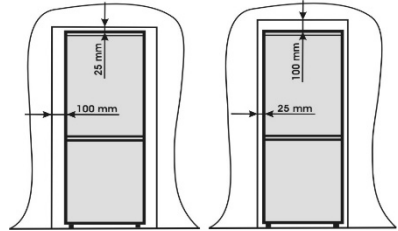

5. Fit the two plastic wall spacers supplied with the appliance rotating 1/4 turn to the condenser at the back of the refrigerator.

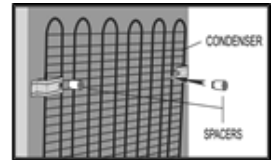

6. The fridge/freezer should be located on a smooth surface. The two front feet can be adjusted as required. To ensure that, your appliance is standing upright adjust the two front feet by turning clockwise or anti-clockwise, until the product is in firm contact with the floor. Correct adjustment of feet avoids excessive vibration and noise.

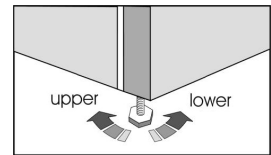

7. Refer to "**CLEANING AND CARE**" section to prepare your appliance for use.

**WARNING!** - Do not connect your appliance to the electricity supply until all the packing and transit protectors have been removed including polystyrene block(s) inserted between the compressor motor and the cabinet (see diagram). Do not remove the plastic drain tray fitted above the compressor motor on models with auto-defrost fridge.

8. To take out the baskets from the freezer compartment please proceed as in item:

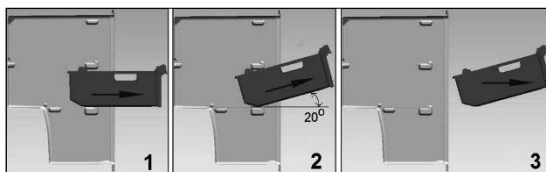

## GETTING TO KNOW YOUR FRIDGE FREEZER

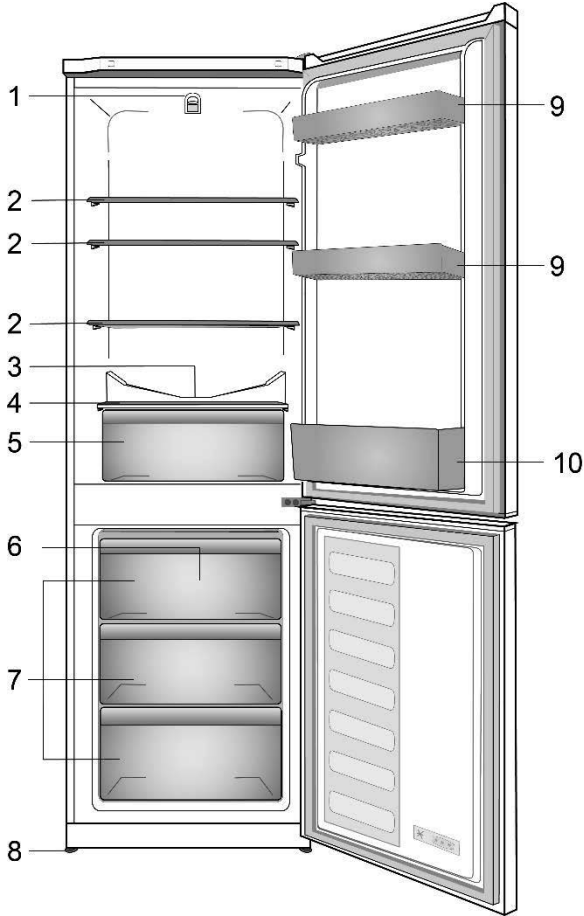

- |   |  |
|---|--|
| <b>1.</b> Thermostat control and interior light | <b>6.</b> Ice tray                     |
| <b>2.</b> Cabinet shelves                       | <b>7.</b> Frozen foods storage drawers |
| <b>3.</b> Defrost water collection channel      | <b>8.</b> Adjustable feet              |
| <b>4.</b> Salad crisper cover                   | <b>9.</b> Door shelves                 |
| <b>5.</b> Salad crisper                         | <b>10.</b> Bottle shelf                |



Figures in this user manual are schematic and may not match the product exactly. If the subject parts are not included in the product you have purchased, then those parts are valid for other models.

# REVERSING THE DOORS

Proceed in numerical order

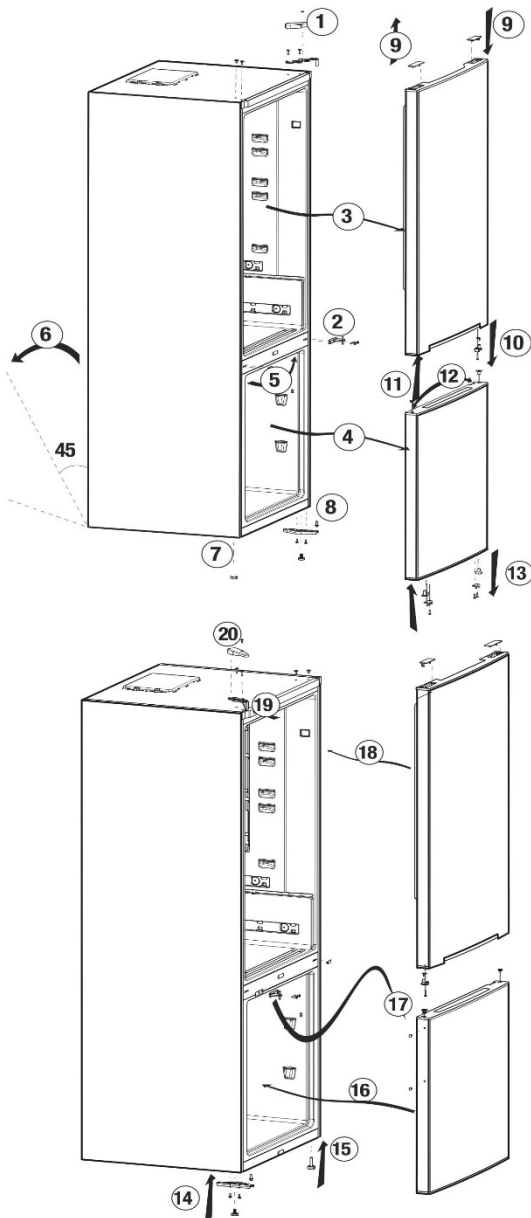



## SUGGESTED ARRANGEMENT OF FOOD IN THE FRIDGE FREEZE

### Arrangement Examples (see diagram)

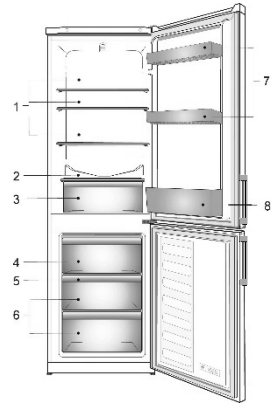
1. Baked, chilled cooked food, dairy products, cans.
2. Meat, sausages, cold cuts.
3. Fruit, vegetables, salads.
4. Frozen food and freezing of fresh food.
5. Making, storing ice cubes.
6. Frozen food.
7. Butter, cheese, eggs, small bottles, cans, tubes.
8. Tall, large bottles, beverages.



The following guidelines and recommendations are suggested to obtain the best results and storage hygiene.

1. The fridge compartment is for the short term storage of fresh food and drinks.
2. The freezer compartment is  rated and suitable for the freezing and storage of pre frozen food. The recommendation for  storage as stated on the food packaging should be observed at all times.
3. Cooked dishes must be stored in airtight covered containers.
4. Fresh wrapped produce can be placed on the shelf. Fresh fruit and vegetables should be cleaned and stored in the crisper bins.
5. Bottles can be placed in the door section.
6. To store raw meat, wrap in polythene bags and place on the lowest shelf. Do not allow to come into contact with cooked food to avoid contamination. For safety, only store raw meat for two to three days.
7. Keep the food packed wrapped or covered. Allow hot food and beverages to cool before placing them in the fridge. Do not store explosive substances. High proof alcohol must be stored upright in sealed containers. Left over canned food should not be stored in the can.
8. Fizzy drinks should not be frozen and products such as flavoured water ices should not be consumed too cold.
9. Some fruit and vegetables suffer damage if kept at temperatures near 0°C. Therefore, wrap pineapples, melons, cucumbers, tomatoes and similar produce in polythene bags.
10. Place chilled cooked food and similar food near the rear of the fridge inner liner where the cold wall is located.
11. Shelves, racks, crisper bins, drawers, flaps, bottle grippers are all removable.

12. Do not leave frozen food at room temperature to thaw; the best way to defrost food is to put it in the fridge to thaw slowly. Make sure you avoid defrosting food or food juices drip onto other food.
13. For hygiene reasons, always wrap food using a suitable packaging material before storing in your appliance to avoid contact with the appliance surface.

## **Guidance for storing fresh food:**

### **Storing into the fresh food compartment:**

- Keep your fridge at recommended temperature level as 4°C.
- Food to be stored should be properly sealed to avoid odour or taste alterations.
- Do not store excessive quantities of food inside your refrigerator. Leave spaces between foods to allow cold air flowing around them to achieve a better and more homogeneous cooling.
- To allow shorter door openings, foods eaten daily should be stored at the front of the shelf.
- Leave a gap between foods and the inner walls, allowing air to flow. If you store foods against the rear wall foods could freeze against rear wall.
- Hot, cooked food must be cooled down at room temperature before storing in the appliance. Then, warm food can be stored in the lower shelves of your fridge. Please do not put warm food nearby highly perishable foods.
- Thaw your frozen food in the fresh food compartment. This way, you can use the frozen food to cool down the fresh food compartment and save energy.
- If unripe tropical fruits (mango, melons, papaya, banana, pineapple) are stored in refrigerator, ageing process can be accelerated and it is not advisable since it causes shorter storage times. However, the ripening of strongly green fruits (apple, pear) can be promoted for a certain period in fridge compartment.
- Onions, garlic, ginger and other root vegetables should be stored at dark and cool room conditions, not in the fridge.
- When a spoiled food inside refrigerator is realized, it should be disposed. When rotten food is noticed, please clean inner liner or accessories which were in contact to prevent contamination.
- Large pots of food, such as soups or stews can be divided into shallow containers to quickly cool in the refrigerator. Large pieces of cooked meat and whole poultry should be divided into smaller pieces for the same purpose.
- Do not store unpacked foods nearby eggs.
- Keep fruits and vegetables separate and store like with like: apples with apples, carrots with carrots. Fruits and vegetables give off different gases that can cause others to deteriorate.

- Take leafy greens out of plastic bags, wrap them in a paper towel or tea towel before storing in refrigerator. Do not forget to dry them if they are rinsed or wet before storing.
- Store fruits and vegetables susceptible to drying out in perforated or unsealed plastic bags to maintain a moist environment yet still allow air to circulate.
- Different foods should be placed in different areas according to their properties:

“Please check appropriate Climate Class of your appliance rated on the rating plate. One of below information is valid for your appliance according to rated Climate Class.”

**SN: Extended Temperate:** This refrigerating appliance is intended to be used at ambient temperatures ranging from 10°C to 32°C.

**N: Temperate:** This refrigerating appliance is intended to be used at ambient temperatures ranging from 16°C to 32°C.

**ST: Subtropical:** This refrigerating appliance is intended to be used at ambient temperatures ranging from 16°C to 38°C.

**T: Tropical:** This refrigerating appliance is intended to be used at ambient temperatures ranging from 16°C to 43°C.

Food	Location
Eggs	Door rack
Dairy products (butter, cheese)	If available, biofresh or chiller compartment / Lowest shelves
Fruits, vegetables and salad	Fruit and vegetable box, crisper or EverFresh+ compartment (if available)
Fresh meat, poultry, fresh fish, sausages, cooked foods	If available, biofresh or chiller compartment / Lowest shelf
Ready to eat foods, packaged products, canned foods, pickled products	Upper shelves or door rack
Drinks, bottles, condiments, snacks	Door rack
Leftovers	Middle shelves

### Storing into the freezer compartment:

- It is recommended to keep freezer setting at -18 °C except extreme ambient conditions.
- Hot food must be cooled to room temperature before storing in the freezer compartment.
- Food cut into small portions will freeze faster and be easier to defrost and cook.
- It is better to pack food before putting it into the freezer.

- In order to avoid expiry of storage periods, please note the freezing date, time limit and name of the food on the packaging according to the storage periods of different foods.
- Do not exceed the food storage times recommended by the food manufacturers. Only take the required amount of food out of the freezer.
- Consume defrosted food quickly. Defrosted food cannot be re-frozen unless it is cooked. It is not safe to consume uncooked re-frozen fresh food.
- When freezing fresh food, avoid bringing it in contact with already frozen food. It may cause thawing of already frozen pieces.

**When storing commercially frozen foods, please follow these guidelines:**

Always follow manufacturers’ guidelines for the length of time you should store the food for. Do not exceed these guidelines!

- Try to keep the length of time between purchase and storage as short as possible to preserve food quality.
- Buy frozen foods, which have been stored at a temperature of -18°C or below.
- Avoid buying food which has ice or frost on the packaging – This indicates that the products might have been partially defrosted and refrozen at some point – temperature rises affect the quality of food.
- We recommend a temperature setting of 4°C for fresh food compartment and -18 °C for freezer compartment to achieve better food preservation.
- With the exception of extreme conditions in ambient, if temperature is set to recommended values as +4°C / -18°C, overall freshness will be prolonged within fresh food and freezer compartments. If temperature of fresh food compartment is set to cooler, fresh fruits and vegetables may be partially frozen or exposed to cold injury, while warmer temperature level may cause faster spoilage of highly perishable foods (dairy products, meat products).

**TEMPERATURE CONTROL AND ADJUSTMENT**

Operating temperatures are controlled by the thermostat Knob and may be set at any position between 1 and 5 (the coldest position). The average temperature inside the fridge should be around +5°C (+41°F). Therefore, adjust the thermostat to obtain the desired temperature. Some sections of the fridge may be cooler or warmer (such as salad crisper and top part of the cabinet) which is quite normal.

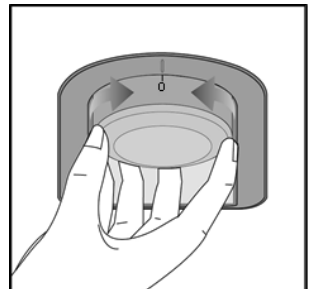

We recommend that you check the temperature periodically with a thermometer to ensure that the cabinet is kept to this temperature.

Frequent door openings cause internal temperatures to rise, so it is advisable to close the door as soon as possible after use.

## **BEFORE OPERATING**

### **Final Check**

Before you start using the appliance check that:

- 1.** The feet have been adjusted for perfect levelling.
- 2.** The interior is dry, and air can circulate freely at the rear.
- 3.** The interior is clean as recommended under "CLEANING AND CARE."
- 4.** The plug has been inserted into the wall socket and the electricity is switched on. When the door is open the interior light will come on.

### **And note that:**

- 5.** You will hear a noise as the compressor starts up. The liquid and gases sealed within the refrigeration system may also make some (noise), whether the compressor is running or not. This is quite normal.
- 6.** Slight undulation of the top of the cabinet is quite normal due to the manufacturing process used; it is not a defect.
- 7.** We recommend setting the thermostat knob midway and monitor the temperature to ensure the appliance maintains desired storage temperatures (see section **TEMPERATURE CONTROL AND ADJUSTMENT**).
- 8.** Do not load the appliance immediately it is switched on. Wait until the correct storage temperature has been reached. We recommend checking the temperature with an accurate thermometer (see **TEMPERATURE CONTROL AND ADJUSTMENT**).

## **STORING FROZEN FOOD**

Your freezer is suitable for the long-term storage of commercially frozen foods and also can be used to freeze and store fresh food. If there is a power failure, do not open the door. Frozen food should not be affected if the failure lasts for less than 13 hours. If the failure is longer, then the food should be checked and either eaten immediately or cooked and then re-frozen!

## FREEZING FRESH FOOD

Please observe the following instructions to obtain the best results.

Do not freeze too large a quantity at any one time.

The quality of the food is best preserved when it is frozen right through to the core as quickly as possible. Do not exceed the freezing capacity of your appliance in 24 h. Placing warm food into the freezer compartment causes the refrigeration machine to operate continuously until the food is frozen solid. This can temporarily lead to excessive cooling of the refrigeration compartment. When freezing fresh food, keep the thermostat knob at medium position. Small quantities of food up to 1/2 kg. (1 lb) can be frozen without adjusting the temperature control knob. Take special care not to mix already frozen food and fresh food.

## MAKING ICE CUBES

Fill the ice - cube tray 3/4 full with water and place it in the Ice Bank. Loosen frozen trays with the handle of a spoon, never use sharp edged objects such as knives, forks. Store ice-cubes in the Ice Bank.

**Note:** If freshly made ice cubes are not consumed for several weeks and stored in Ice Bank, they will slowly reduce in size and eventually disappear completely.

## CRISPER

The refrigerator's crisper is designed to keep vegetables fresh by preserving their humidity. For this purpose, the overall cold air circulation is intensified in the crisper. Keep fruits and vegetables in this compartment. Keep the green-leaved vegetables and fruits separately to prolong their life.

## DEFROSTING

### A) Fridge compartment

The fridge compartment defrosts automatically.

The defrost water runs to the drain tube via a collection container at the back of the appliance **(1)**.

During defrosting, water droplets may form at the back of the fridge compartment where a concealed evaporator is located. Some droplets may remain on the liner and refreeze when defrosting is completed. Do not use pointed or sharp-edged objects such as knives or forks to remove the droplets which have refrozen. If, at any time, the defrost water does not drain from the collection channel, check that no food particles have blocked the drain tube. The drain tube can be cleared with a pipe-cleaner or pushing the special plastic plunger provided down the drain tube **(2)**.

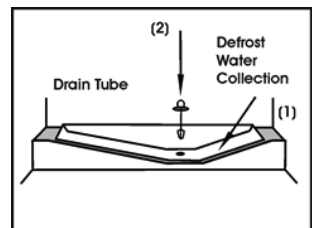

**Please flush with approximately 100 ml of warm tap water, to ensure that the water drains. If the blockage is still present, use a suitable "refrigerator drain cleaning tool", and flush with approximately 100 ml of warm tap water.**

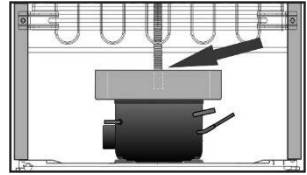

**NOTE: Do not flush with excessive water, this will cause the evaporator tray at the back of the appliance to overflow and cause a leak. If the problem persists please contact service.**

Check that the tube is permanently placed with its end in the collecting tray on the compressor to prevent the water spilling.

### **B) Freezer compartment**

Defrosting is very straightforward and without mess, thanks to a special defrost collection basin. Defrost twice a year or when a frost layer of around 7 (1/4") mm has formed. To start the defrosting procedure, switch off the appliance at the socket outlet and pull out the mains plug. All food should be wrapped in several layers of newspaper and stored in a cool place (e.g. fridge or larder). Containers of warm water may be placed carefully in the freezer to speed up the defrosting.

**Do not use pointed or sharp-edged objects, such as knives or forks to remove the frost.**

**Never use hairdryers, electrical heaters or other such electrical appliances for defrosting.**

Sponge out the defrost water collected in the bottom of the freezer compartment. After defrosting, dry the interior thoroughly. Insert the plug into the wall socket and switch on the electricity supply.

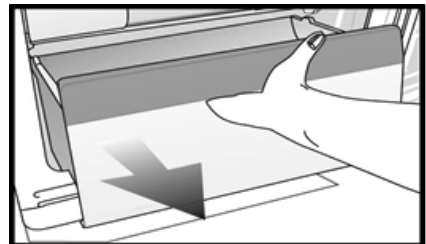

## REPLACING THE INTERIOR LIGHT BULB

To change the Bulb/LED used for illumination of your refrigerator, call your Authorised Service. The lamp(s) used in this appliance is not suitable for household room illumination. The intended purpose of this lamp is to assist the user to place foodstuffs in the refrigerator/freezer in a safe and comfortable way. The lamps used in this appliance have to withstand extreme physical conditions such as temperatures below -20°C.

## CLEANING AND CARE

- 1.** We recommend that you switch off the appliance at the socket outlet and pull out the mains plug before cleaning.
- 2.** Never use any sharp instruments or abrasive substances, soap, household cleaner, detergent or wax polish for cleaning.
- 3.** Use lukewarm water to clean the cabinet of the appliance and wipe it dry.
- 4.** Use a damp cloth wrung out in a solution of one teaspoon of bicarbonate of soda to one pint of water to clean the interior and wipe it dry.
- 5.** Make sure that no water enters the temperature control box.
- 6.** If the appliance is not going to be used for a long period of time, switch it off, remove all food, clean it and leave the door ajar.
- 7.** Any dust that gathers on the condenser, which is located at the back of the appliance, should be removed once a year with a vacuum cleaner.
- 8.** Check door seals regularly to ensure they are clean and free from food particles.
- 9.** Never:
  - Clean the appliance with unsuitable material, e.g. petroleum based products.
  - Subject it to high temperatures in any way.
  - Scour, rub, etc., with abrasive material.
- 10.** Removal of door tray:
  - To remove a door tray, remove all the contents and then simply push the door tray upwards from the base.
- 11.** Make sure that the special plastic container (drain tray) at the back of the appliance which collects defrost water is clean at all times. If you want to remove the tray to clean it follow the instructions below:
  - Switch off at the socket outlet and pull out the mains plug.
  - Push the lug down with the tip of a screwdriver & pull out with a jerk movement.
  - Clean the drain tray and wipe it dry.
  - Reassemble, reversing the sequence and operations.

12. To remove a freezer drawer, pull it as far as possible, tilt it upwards and then pull it out completely.

## DO'S AND DON'TS

- Do -** Clean and defrost your appliance regularly (see "**CLEANING AND CARE**").
- Do -** Keep raw meat and poultry below cooked food and dairy products.
- Do -** Take off any unusable leaves on vegetables and wipe off any soil.
- Do -** Leave lettuce, cabbage, parsley and cauliflower on the stem.
- Do -** Wrap cheese firstly in greaseproof paper and then in a polythene bag, excluding as much air as possible. For best results, take out of the fridge compartment an hour before eating.
- Do -** Wrap raw meat and poultry loosely in polythene or aluminium foil. This prevents drying.
- Do -** Wrap fish and offal in polythene bags.
- Do -** Wrap food with a strong odour or which may dry out, in polythene bags, or aluminium foil or place in airtight container.
- Do -** Wrap bread well to keep it fresh.
- Do -** Chill white wines, beer, lager and mineral water before serving.
- Do -** Check contents of the freezer every so often.
- Do -** Keep food for as short a time as possible and adhere to "**Best Before**" and "**Use by**" etc. dates.
- Do -** Store commercially frozen food in accordance with the instructions given on the packets.
- Do -** Always choose high quality fresh food and be sure it is thoroughly clean before you freeze it.
- Do -** Prepare fresh food for freezing in small portions to ensure rapid freezing.
- Do -** Wrap all food in aluminium foil or freezer quality polythene bags and make sure any air is excluded.
- Do -** Wrap frozen food immediately after purchasing and put it in to the freezer as soon as possible.
- Do -** Defrost food in the fridge compartment.
- Do -** Remove ice cream from the freezer 10-20 minutes before serving.
- Don't -** Store bananas in your fridge compartment.
- Don't -** Store melon in your fridge. It can be chilled for short periods as long as it is wrapped to prevent it flavouring other food.

- Don't -** Cover the shelves with any protective materials which may obstruct air circulation.
- Don't -** Store poisonous or any dangerous substances in your appliance. It has been designed for the storage of edible foodstuffs only.
- Don't -** Consume food which has been stored for an excessive length of time.
- Don't -** Store cooked and fresh food together in the same container. They should be packaged and stored separately.
- Don't -** Let defrosting food or food juices drip onto food.
- Don't -** Leave the door open for long periods, as this will make the appliance more costly to run and cause excessive ice formation.
- Don't -** Use sharp edged objects such as knives or forks to remove the ice.
- Don't -** Put hot food into the appliance. Let it cool down first.
- Don't -** Put liquid-filled bottles or sealed cans containing carbonated liquids into the freezer, as they may burst.
- Don't -** Exceed the maximum freezing loads (4 kg in any 24 hours) when freezing fresh food.
- Don't -** Give children ice-cream and water ices direct from the freezer. The low temperature may cause 'freezer burns' on lips.
- Don't -** Freeze fizzy drinks.
- Don't -** Try to keep frozen food which has thawed; it should be eaten within 24 hours or cooked and refrozen.
- Don't -** Remove items from the freezer with wet hands.
- Don't -** Close the freezer door before placing the compartment cover in its place.
- Don't -** Leave frozen food at room temperature to thaw; the best way to defrost food is to put it in the fridge to thaw slowly. Make sure you avoid defrosting food or food juices drip onto other food.

## **ENERGY SAVING TIPS**

- 1.** Ensure your appliance is installed in a well-ventilated area. If the ambient temperature is low (but in no case lower than 10 degrees C), then the energy saving will be more. In this case, check temperatures of fridge and freezer compartments with an accurate thermometer and lower the thermostat setting (towards 1) if necessary.
- 2.** Ensure the time between buying chilled/frozen food and placing them in your appliance is kept at minimum, particularly in summer. We recommend you use a cool bag or a special carrier bag to carry frozen food.

3. Do not leave the door (s) of your appliance open longer than necessary and ensure they are closed properly after each opening.
4. Defrost frozen food in the fridge compartment, so that frozen food acts as an ice pack to assist cooling in the fridge.

## **PROBLEM SOLVING**

If the appliance does not operate when switched on, check whether:

- The plug is inserted properly in the socket and that the power supply is on. (To check the power supply to the socket, plug in another appliance).
- The fuse has blown/circuit breaker has tripped/main distribution switch has been turned off.
- The temperature control has been set correctly.
- New plug is wired correctly if you have changed the fitted moulded plug.

If the appliance is still not operating after the above checks, please refer to the section on **“HOW TO OBTAIN SERVICE”**.

Please ensure that above checks have been made as a charge will be made if no fault is found.

## DISCLAIMER / WARNING

Some (simple) failures can be adequately handled by the end-user without any safety issue or unsafe use arising, provided that they are carried out within the limits and in accordance with the following instructions (see the “Self-Repair” section).

Therefore, unless otherwise authorized in the “Self-Repair” section below, repairs shall be addressed to registered professional repairers in order to avoid safety issues.

A registered professional repairer is a professional repairer that has been granted access to the instructions and spare parts list of this product by the manufacturer according to the methods described in legislative acts pursuant to Directive 2009/125/EC.

**However, only the service agent (i.e. authorized professional repairers) that you can reach through the phone number given in the user manual/warranty card or through your authorized dealer may provide service under the guarantee terms. Therefore, please be advised that repairs by professional repairers (who are not authorized by manufacturer / seller) shall void the guarantee.**

### Self-Repair

Self-repair can be done by the end-user with regard to the following spare parts: door handles, door hinges, trays, baskets and door gaskets (an updated list is also available in web as of 1st March 2021).

Moreover, to ensure product safety and to prevent risk of serious injury, the mentioned self-repair shall be done following the instructions in the user manual for self-repair or which are available in web. For your safety, unplug the product before attempting any self-repair.

Repair and repair attempts by end-users for parts not included in such list and/ or not following the instructions in the user manuals for self-repair or which are available in web, might give raise to safety issues not attributable to manufacturer / seller, and will void the warranty of the product.

Therefore, it is highly recommended that end-users refrain from the attempt to carry out repairs falling outside the mentioned list of spare parts, contacting in such cases authorized professional repairers or registered professional repairers. On the contrary, such attempts by end-users may cause safety issues and damage the product and subsequently cause fire, flood, electrocution and serious personal injury to occur. By way of example, but not limited to, the following repairs must be addressed to authorized professional repairers or registered professional repairers: compressor, cooling circuit, main board, inverter board, display board, etc.

The manufacturer / seller cannot be held liable in any case where end-users do not comply with the above.

