

Hotpoint

Washing Machine

User Manual



HBWH 93 CARE UK

2820533908/ EN/ / 8.10.2025 13:25

Please read this user manual first!

Dear Customer,

Thank you for choosing Hotpoint product.

We hope that you get the best results from your product which has been manufactured with high quality and state-of-the-art technology. Therefore, please read this entire user manual and all other accompanying documents carefully before using the product.

Follow all warnings and information in the user manual. Thus, you protect yourself and your product against possible dangers.

Keep the user manual. If you hand over the product to someone else, provide the user manual as well. Warranty terms, usage and troubleshooting methods of your product are in user manual.

Symbols and Definitions

The following symbols are used in the user manual:







	Danger that could result in death or injury.
	Important information or useful hints about usage.
	Read the user manual.
	Recyclable materials.
	Hot surface warning.
	
WARNING	Danger that may result in property damage to the product or its environment.

Table of Contents

1 Safety Instructions	4	6.7 Spin Speed Selection.....	26
1.1 Intended Use.....	4	6.8 Auxiliary Function Selection.....	26
1.2 Safety of Children, Vulnerable Persons and Pets	4	6.8.1 Auxiliary Functions.....	27
1.3 Electrical Safety.....	5	6.8.2 Functions/Programmes Selected by Pressing the Function Buttons for 3 Seconds	27
1.4 Handling Safety	6	6.9 End Time	28
1.5 Installation Safety.....	6	6.10 Starting the Program	29
1.6 Operational Safety.....	8	6.11 Loading Door Lock.....	29
1.7 Maintenance and Cleaning Safety	9	6.12 Changing Selections After Program Starts.....	29
2 Important Instructions for Environment	10	6.13 Cancelling the Programme	30
2.1 Compliance with WEEE Directive .	10	6.14 End of Programme.....	30
2.2 Package Information.....	10	7 Maintenance and Cleaning	30
3 Technical Specifications	11	7.1 Cleaning the Detergent Drawer	31
4 Installation	12	7.2 Cleaning the Loading Door and the Drum	31
4.1 Unpacking and Transporting the Product.....	12	7.3 Cleaning the Body and Control Panel.....	31
4.2 Appropriate Installation Location.	12	7.4 Cleaning the Water Intake Filters..	31
4.3 Assembly of Bottom Panel Covers.....	13	7.5 Draining Remaining Water and Cleaning the Pump Filter	32
4.4 Removing Transportation Safety Bolts	13	8 Troubleshooting	33
4.5 Connecting to Water Supply	14	9 DISCLAIMER	37
4.6 Connecting the Drain Hose to the Drain	14		
4.7 Adjusting the Feet	15		
4.8 Electrical Connection	15		
4.9 Start Up	15		
5 Preliminary Preparation	15		
5.1 Sorting the Laundry	16		
5.2 Preparing Laundry for Washing....	16		
5.3 Tips for Energy and Water Saving	16		
5.4 Loading the Laundry.....	16		
5.5 Correct Load Capacity	16		
5.6 Using Detergent and Softener	17		
5.7 Tips for Efficient Washing	19		
5.8 Displayed Programme Duration ...	19		
6 Operating the Product	20		
6.1 Control Panel	20		
6.2 Symbols on the Display.....	21		
6.3 Programme Table.....	21		
6.4 Programme Selection	23		
6.5 Programmes	23		
6.6 Temperature Selection.....	25		



1 Safety Instructions

This section contains safety instructions to help prevent personal injury or property damage. Our company cannot be held responsible for any damages that may occur if these instructions are not followed.

- Always have installation and repairs done by an authorized service.
- Use only original spare parts and accessories.
- Do not repair or replace any part of the product unless expressly stated in the user manual.
- Do not make technical changes to the product.



1.1 Intended Use

- The product's service life is 10 years. During this period, original spare parts will be available to operate the product properly.
- This product is designed for household use. It is not intended for commercial use. Do not use the product for any other purpose.
- Use only for washing and rinsing textiles with the appropriate marking.

- This product is designed for indoor use, such as in homes and similar locations. For example;
 - Staff kitchens of stores, offices and other work environments,
 - Farmhouses,
 - By customers of hotels, motels and other accommodation facilities,
 - Bed and breakfast establishments, hostel-like environments,
 - Common areas of apartment blocks or laundries.



1.2 Safety of Children, Vulnerable Persons and Pets

- This product may be used by children aged 8 years and older and persons with reduced physical, sensory or mental capabilities or lack of experience and knowledge if they have been given supervision or instruction concerning use of the product in a safe way and understand the hazards involved.
- Children under the age of 3 should be kept away unless continuously supervised.

- Electrical products are dangerous for children and pets. Children or pets should not play with, climb on top or inside the product. Check inside the product before use.
- Use child lock to prevent children from interfering with the product.
- Do not forget to close the loading door when leaving the room where the product is located. Children and pets may get locked inside and drown.
- Children should not perform cleaning and user maintenance works without an adult's supervision.
- Keep the packaging materials away from children. Risk of injury and suffocation.
- Keep all detergents and additives used for the product out of children's reach.
- Cut the power cable and break and deactivate the locking mechanism of the loading door before disposing of the product for children's safety.
- Damaged power cables should be replaced by the authorised service in order to prevent possible danger.
- Do not tuck the power cord under the product or to the rear of the product. Do not put heavy items on the power cord. Do not bend, crush, or expose the power cable to heat sources.
- Only use the original cable. Do not use cut or damaged cables.
- Do not use an extension cord, multi-plug or adaptor to operate your product.
- Extension cords, multi-socket outlets, adapters or portable power supplies can overheat and cause a fire. Make sure not to place power sockets and portable power supplies near or behind the product.
- The plug shall be easily accessible. If this is not possible, a mechanism that meets the electrical legislation and that disconnects all terminals from the mains (fuse, switch, main switch, etc.) shall be available on the electrical installation.

1.3 Electrical Safety

- Product should be unplugged during installation, maintenance, cleaning and repair procedures. Unplug the product or turn off the fuse.
- Do not touch the plug with wet hands.
- When unplugging the product, do not hold the power cord, but the plug.

- Make sure the plug is not wet, dirty or dusty.
- Never connect your product to electricity saving devices. Such systems are harmful to the product.

1.4 Handling Safety

- Unplug the product before moving, remove the water outlet and water main connections. Drain any water left inside the product.
- This product is heavy, do not handle it by yourself. It may cause injuries if your product falls on you. Do not hit and drop the product while carrying.
- Do not hold parts such as the laundry loading door to lift and move the product. The upper tray should be tightly fixed for moving.
- Carry the product in an upright position. If it cannot be carried upright, tilt it to the right side in frontal view.
- Make sure that the hoses as well as the power cable are not folded, pinched or crushed after the product is fitted into its place after installation or cleaning procedures.

1.5 Installation Safety

- Check the information in the manual and installation instructions to prepare the product for installation and make sure the electrical mains, clean water mains and water outlet are suitable. If not, call a qualified electrician and plumber to have them make the necessary arrangements. These operations are the responsibility of the customer.
- Prior to commencing the installation, be sure to switch off the fuse to deactivate the power supply for the line to which the product will be connected.
- This product is intended for use at altitudes not exceeding 2000 meters above sea level.
- Check the product for any damage before installing it.
- Always wear personal protective equipment (gloves, etc.) during product installation, maintenance and repair. There is a risk of injury.
- Injuries may occur if hands are put into uncovered slots. Close the holes of the transportation safety bolts with plastic plugs.

- Do not install or leave the appliance in areas exposed to environmental conditions like rain or sunlight.
- Do not install the product at locations where the temperature drops below 0 °C.
- Do not place the product on a carpet or similar surface. It would create fire hazard since it cannot receive air from underneath.
- Place the product on a level and hard surface and balance with the adjustable feet.
- Connect the product to a grounding plug protected by a fuse suitable to the current values on the type label. Make sure the grounding is carried out by an expert electrician. As required by local and national regulations, do not use the product without proper grounding.
- Plug the product in a socket with voltage and frequency values suitable to those indicated on the type label.
- Do not plug the product into loose, broken, dirty, greasy, or water-damaged sockets.
- Use the new hose set provided with the product. Do not re-use old hose sets. Do not extend the hoses.
- Connect the water inlet hose directly to the water tap. The pressure from the tap should be minimum 0.1 MPa (1 bar) and maximum 1MPa (10 bars). 10 to 80 litres of water should be running from the tap in a minute in order for the product to function properly. If the water pressure is above 1 MPa (10 bars), a pressure-reducing valve should be fitted. The maximum allowed temperature is 25°C.
- Fit the end of the water discharge hose to the wastewater drain, the sink or the bathtub.
- Place the power cable and hoses in locations without risk of tripping.
- Do not install the product behind a door, a sliding door or at another location that will prevent the door from opening completely.
- If a dryer is to be placed on the product, fix with a suitable connection apparatus obtained from the authorised service.
- There is a risk of contact with electrical components when the upper tray is removed. Do not dismantle the upper tray of the product.
- Keep the appliance at least 1 cm from furniture.

1.6 Operational Safety

- When you are using the product, use only detergents, softeners, and additives suitable for washing machines.
- Do not use chemical solvents on the product. These materials contain an explosion risk.
- Do not operate defective or damaged products. Unplug the product (or turn off the fuse it is connected to), turn off the water tap and call an authorised service.
- Do not place sources of ignition (burning candle, cigarettes, etc.) or sources of heat (irons, cooktops, ovens, etc.) on top of or near the product. Do not put inflammable/explosive materials near the product.
- Do not stand or climb on the product.
- Unplug the product and turn off the tap if you will not be using the product for long periods.
- Avoid opening the detergent drawer while the product is running to prevent splashes. Contact of the detergent with your skin and eyes is dangerous.
- Make sure pets do not climb inside the product. Check inside the product before use.
- Do not force open the locked loading door. The door will open once the washing is completed. If the door does not open, use the solutions for “loading door does not open” error in the Troubleshooting section.
- Do not wash items contaminated with gasoline, kerosene, benzene, reducers, alcohol or other inflammable or explosive materials and industrial chemicals.
- Do not directly use dry cleaning detergent and do not wash, rinse or spin laundry contaminated with dry cleaning detergent.
- Do not place your hands into the rotating drum. Wait until the drum no longer rotates.
- If washing laundry at high temperatures, the discharged washing water would burn your skin if in contact with your skin, for ex. when the draining hose is connected to the tap. Do not touch the discharge water.
- Take the following precautions to prevent formation of biofilm and malodours:

- Make sure the room where the product is placed is well ventilated.
- Wipe the door gasket and loading door glass with a dry and clean cloth at the end of the programme.
- The glass of the loading door will heat up when washing at high temperatures. To avoid burns, do not touch the loading door glass and keep children away from the product during operation.
- Before disposing of old and inoperable products:
 1. Unplug the power plug and remove it from the socket.
 2. Cut the power cable and disconnect it with the plug from the product.
 3. Break the locking mechanism of the loading door to render it inoperable.
 4. Do not allow children to play with the discarded product.
- If you need to move the product for cleaning, do not pull on the loading door. The door can break and cause injury!
- Do not put hands, feet and metal objects under or behind your product. This can cause jams, and any sharp edge can cause personal injury.
- Use a clean, dry cloth to wipe foreign material or dust from the plug ends. When cleaning the plug, do not use a wet or damp cloth. Otherwise, there is a risk of fire or electric shock.
- Do not wash the product with pressure washers, by spraying vapour, water or pouring water. There is a risk of electrocution.
- Do not use sharp or abrasive tools to clean the product. Do not use household cleaners, soap, detergent, gas, gasoline, thinner, alcohol, varnish, etc. while cleaning.
- Cleaning agents containing solvents (e.g. cleaning solvent) might reek poisonous fumes. Do not use cleaning products containing solvents.
- There may be detergent residues in the detergent drawer when you open it for cleaning.



1.7 Maintenance and Cleaning Safety

- Before cleaning or servicing the product, unplug it or cut the power at the fuse.

- Do not dismantle the filter of the discharge pump while the product is running.
- The temperature in the product may rise up to 90°C. Clean the filter after the water in the product cools down in order to avoid risk of getting burnt.

2 Important Instructions for Environment

2.1 Compliance with WEEE Directive



This product complies with EU WEEE Directive (2012/19/EU). This product bears a classification symbol for waste electrical and electronic equipment (WEEE).

This product has been manufactured with high quality parts and materials which can be reused and are suitable for recycling. Do not dispose of the waste product with normal domestic and other wastes at the end of its service life. Take it to the collection center for the recycling of electrical and electronic equipment. Please consult your local authorities to learn about these collection centers.

Compliance with RoHS Directive:

The product you have purchased complies with EU RoHS Directive (2011/65/EU). It does not contain harmful and prohibited materials specified in the Directive.

2.2 Package Information

Packaging materials of the product are manufactured from recyclable materials in accordance with our National Environment Regulations. Do not dispose of the packaging materials together with the domestic or other wastes. Take them to the packaging material collection points designated by the local authorities.

3 Technical Specifications

Supplier's name or commercial brand	HOTPOINT
Model name	HBWH 93 CARE UK
	457100061300
Nominal Capacity (kg)	9
Maximum spin speed (cycle/min)	1400
Built-In	No
Height (cm)	84,5
Width (cm)	60
Depth (cm)	58
Single Water inlet / Double Water inlet	+ / -



The model information as stored in the product database can be reached by entering following website and searching for your model identifier (*) found on energy label.

<https://eprel.ec.europa.eu/>

















































SUPPLIER'S NAME



MODEL IDENTIFIER → (*)



Symbols Table

											
Prewash	Fast	Fast+	Extra Rinse	Extra Water	Anti Crease	Pet Hair Removal	Steam	Night Mode	Soaking	Rinse Hold	
											
AutoDose	Liquid Detergent Selection	Softener Selection	Rinse	Spin+Drain	Drain	Temperature	Spin	No Spin	Tap Water (Cold)	No Water	Time Delay
											
Door Lock	Child Lock	On/Off	Start / Pause	Soil Level	Add Garment	Downloaded Program	Wash	Ok (End)	Cancel	AntiCrease+	Drying
											
Steeping	Extra Dry	Cupboard Dry	Iron Dry	Timed Drying	Clean & Wear	Intensive	Water Mode		Water Saving	Temperature	FreshCare

4 Installation



Please read the "Safety Instructions" section first!



Your product automatically detects the amount of laundry placed inside when selecting a programme.

While installing the product, before the first use, calibration should be done to ensure that the laundry amount is detected in the most accurate way.

To do this, select the Drum Cleaning* programme and cancel the spin function. Start the programme without laundry. Wait for the programme to finish, which will take about 15 minutes.

*The programme name may vary depending on the model. For the appropriate programme selection, review the programme descriptions section.

- Please contact the nearest Authorised Service for the installation of the product.
- Make sure that the installation and electrical connections of the product are performed by authorised service agent. Manufacturer shall not be held responsible for damages caused by operations performed by unauthorised persons.
- Preparation of the location and electrical, tap water and wastewater installations at the place of installation is under customer's responsibility.
- Make sure that the water inlet and discharge hoses as well as the power cable are not folded, pinched, or crushed while pushing the product into its place after installation or cleaning procedures.
- Prior to installation, visually check if the product has any defects on it. Do not have the product installed if it is damaged. Damaged products cause risks for your safety.

4.1 Unpacking and Transporting the Product

Unpacking the Product

- Remove the cardboard box or Styrofoam packaging.
- To remove the cardboard or Styrofoam packaging underneath the product, lift the product carefully. If this is not possible, remove it by tilting it slightly to the side or by laying it on its side without damaging the product.
- Open the door and remove the inlet hose and any other accessories inside drum.
- Detach the power cable and drain hose from their fixed positions.
- Remove the transportation safety bolts. (see "Removing the Transportation Safety Bolts")

Transporting the Product



Read the "Transportation Safety" section first!

- Ensure the door and detergent drawer are closed.
- Install the transportation safety bolts carefully without damaging the product's drum. (see "Removing the Transportation Safety Bolts")
- Pack the product with protective packaging to prevent damage during transport.

4.2 Appropriate Installation Location

- Place the product on a hard, rigid and level floor. Do not place the product on surfaces such as long-pile carpets or non-slip carpets, or on excessively springy flooring such as acoustic floor coverings. Improper surfaces may cause noise and vibration problems.
- When the washing machine and the dryer are placed on top of each other, their total weight -when full- is approximately 180 kilograms. Place the product on a solid and level surface with sufficient load-carrying capacity.

- Do not place the product on the power cord.
- Do not install the product in places where the temperature drops below 0°C. This may cause damage to your product due to freezing.
- Leave a minimum space of 1 cm between the product and the furniture.
- When installing the appliance on a stepped surface, keep it away from edges.
- Do not place the product on any platform.
- Do not place or use heat sources such as cooktops, irons, ovens, heaters, etc. on the product.

4.3 Assembly of Bottom Panel Covers



With some models, the base parts of the products are completely closed. These products do not have plugs and covers.

- In order to increase the sound comfort of the product, attach cover A after removing the package foam.

Cover A

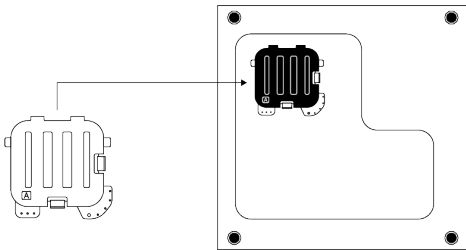

Tilt the product back slightly. Rest the tabs of Cover A against the lower panel. Complete the assembly by rotating the cover.

- Cover B and the Cap are optional. If available, attach cover B and the Cap.

Cover B

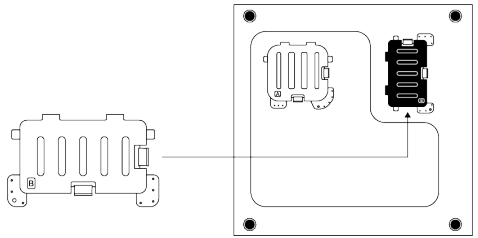

Rest the tabs of Cover B against the lower panel. Complete the assembly by rotating the cover.

Cap

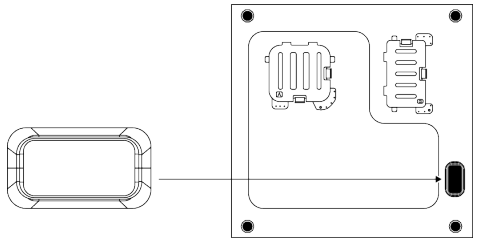

Insert the cap by pushing it with your finger.

4.4 Removing Transportation Safety Bolts

1. Loosen all transportation safety bolts with an appropriate wrench until they turn freely.
2. Bend the inner part by pressing it at the grip areas and pull the part out.
3. Attach the plastic covers supplied in the User Manual bag into the holes on the rear panel.

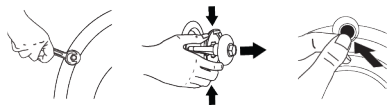

NOTICE

Remove the transportation safety bolts before operating the product. Otherwise, the product will get damaged.



NOTICE

Keep the transportation safety bolts in a safe place to reuse when the product needs to be moved again in the future.

Install the transportation safety bolts in reverse order of the disassembly procedure.

Never move the product without the transportation safety bolts properly fixed in place.

4.5 Connecting to Water Supply



NOTICE

Models with a single water inlet should not be connected to the hot water tap. Laundry may be damaged or the product may go into protection mode and not work. Do not use old or used water inlet hoses on your new product. This may cause water leakage in your product and stains on your laundry.

1. Tighten all hose nuts by hand. Make sure to tighten all hose connections completely. Never use a tool when tightening nuts.
2. After completing hose connection, open the taps all the way and check if there is any water leakage from the connection points. In case of a leakage, turn off the tap and unscrew the nut. Check the seal and tighten the nut carefully again. To prevent possible water leaks and damages that may occur, keep the taps closed when the product is not in use.

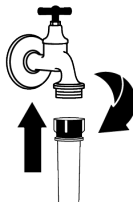
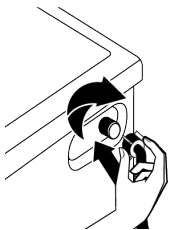

4.6 Connecting the Drain Hose to the Drain

1. Attach the end of the drain hose directly to waste water drain, washbasin or bathtub.



Your house will be flooded if the water draining hose is dislocated during water draining. There is also a risk of burning due to the high washing temperatures. In order to prevent such situations and make sure that the product performs water intake and drain processes without any problem, fix the drain hose securely.

2. Connect the drain hose to a minimum height of 40 cm and a maximum height of 100 cm.
3. Installing the water draining hose at ground level or close to the floor (40 cm below) and then raising it makes water discharge difficult and the laundry may come out extremely wet. Thus, follow the heights provided in the figure.

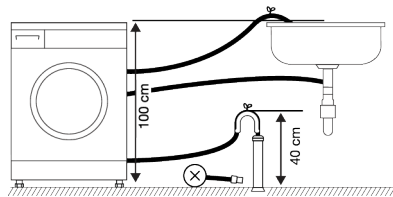

4. To prevent the waste water to go back into the product again and to ensure easy drainage, do not immerse the end of the hose into the waste water or do not insert it into the drain for more than 15 cm. If it is too long, cut it short.
5. The end of the hose should not be bent, it should not be stepped on and the hose must not be pinched between the drain and the product. Otherwise, water discharge issues may emerge.
6. If the length of the hose is too short, use it by adding an original extension hose. The overall length of the hose shall not be longer than 3.2 m. To prevent water

leaks, always secure the connection between the extension hose and the draining hose of the product with a suitable clamp so that it does not come off and cause leaks.

4.7 Adjusting the Feet



NOTICE

In order to ensure that the product operates more silently and vibration-free, it must stand level and balanced on its feet. Adjust the feet to ensure balance. Otherwise, the product may move from its place and cause bumping, noise and vibration problems.

1. To loosen the nuts on the feet, rotate the nuts clockwise using the hand tool.
2. Adjust the feet until the product stands level and stable. To lower the feet, rotate them counterclockwise. To raise the feet, rotate them clockwise.
3. To retighten the nuts, rotate them counterclockwise using the hand tool.

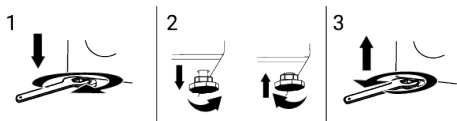

4.8 Electrical Connection

Connect the product to a grounded outlet protected by a 13-amp fuse. Our company shall not be responsible for the damages that shall be incurred due to using the product without grounding according to local regulations.

- Connection must comply with national regulations.

- The electrical connection cable infrastructure of the product must be adequate and suitable for product requirements. It is recommended to use a Ground Fault Circuit Breaker (GFCI).
- Power cable plug must be within easy reach after installation.
- If the current supply to the fuse or breaker in the house is less than 13 amp, have a qualified electrician install a 13-amp supply.
- Your mains voltage must comply with the voltage specified in the “technical specifications” section.
- Do not make connections via extension cables or multi-plugs. Overheating and burning may occur due to the connecting cable.



Damaged power cables should be replaced by the authorised service in order to prevent possible danger.

4.9 Start Up

Before starting to use the product make sure that the preparations described in section “Environmental instructions” and “Installation”. To prepare the product for washing laundry, perform first operation in Drum Cleaning programme. If this programme is not available in your product, apply the method which is described in section “Cleaning the loading door and the drum”.

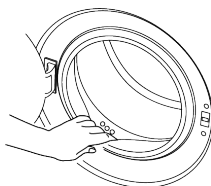

Some water has remained in the product due to the quality control processes in the production. It is not harmful for the product.

5 Preliminary Preparation



Please read the “Safety Instructions” section first!

5.1 Sorting the Laundry

- Sort laundry according to type of fabric, colour, and degree of soiling and allowable water temperature.
- Always observe the instructions given on the garment care labels.

5.2 Preparing Laundry for Washing

- Laundry items with metal attachments such as underwiring, belt buckles or metal buttons will damage the product. Remove the metal pieces or wash such clothes by putting them in a laundry bag or pillow case.
- Take out all items in the pockets such as coins, pens and paper clips, and turn pockets inside out and brush. Such objects may damage the product or cause noise problem.
- Put small size clothes such as infant's socks and nylon stockings in a laundry bag or pillow case.
- Place curtains in without compressing them. Remove all curtain accessories such as rings, hooks, and clips to prevent damage to the curtains.
- Fasten zippers, sew loose buttons on securely, and mend rips and tears.
- Wash "Machine washable" or "Hand washable" labelled products only with an appropriate programme.
- Do not wash colours and whites together. New, dark coloured cottons release a lot of dye. Wash them separately.
- Tough stains must be treated properly before washing.
- Wash trousers and delicate laundry turned inside out.
- Laundry that are subjected to materials such as flour, lime dust, milk powder, etc. intensely must be shaken off before placing into the product. Such dusts and powders on the laundry may build up on the inner parts of the product in time and can cause damage.

5.3 Tips for Energy and Water Saving

The following information will help you use the product in an ecological and energy/water-saving way.

- Operate the at the maximum load capacity for the programme selected, but do not overload it. See "Programme table".
- Follow the temperature recommendations on the detergent packaging.
- Wash your lightly soiled laundry at low temperatures.
- Choose quick programmes for lightly soiled and small amounts of laundry.
- Do not use prewash or high temperatures for laundry that is not heavily dirty or stained.
- If you are going to dry your laundry in the dryer, select the highest spin speed recommended for your washing programme.
- Do not use more detergent than recommended on the detergent packaging.

5.4 Loading the Laundry

1. Open the loading door.
2. Put the laundry items into the product in a loose manner.
3. Push the loading door to close until you hear a locking sound. Ensure that no items are caught in the door. The loading door is locked while a programme is running. The door lock will open once the programme is completed. Then you can open the loading door. If the door does not open, apply the solutions provided for "Loading door cannot be opened" error in the Troubleshooting section.

5.5 Correct Load Capacity

The maximum load capacity depends on the type of laundry, the degree of soiling and the desired washing programme.

The product automatically adjusts the water amount according to the weight of the laundry put inside it.

-  Follow the instructions in “Programme table”. When the product is overloaded product’s washing performance will drop. Moreover, noise and vibration problems may occur.

5.6 Using Detergent and Softener



WARNING

Read the manufacturer's instructions on the packaging when using detergents, softeners, starch, bleach and decolourants, anti-lime scale and follow the dosage information provided. Use a measuring cup, if any.

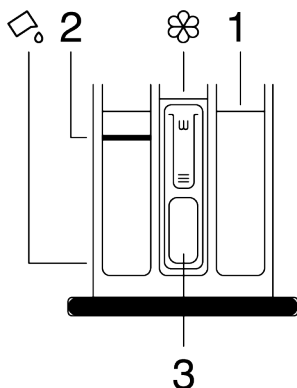

The detergent drawer comprises of three compartments:

- (1) for prewash - if your model has prewash function available,
- (2) for main washing,
- (3) for softener,
- (☞) a syphon piece in the softener compartment,
- (☞) there is a liquid detergent flap for liquid detergent use in the main washing compartment.

Detergent, Softener and Other Cleaning Agents

- Add detergent and softener before starting the washing programme.
- Do not leave the detergent drawer open when the washing programme is on.

- If you are using a programme without prewashing, do not put detergent in the prewash compartment (compartment 1).
- If your model has prewash function available - If you are using a program with prewash, start the product after adding powder detergent to the prewash and main wash compartments (compartments 1 and 2).
- If your model has prewash function available - Do not select a programme with pre-washing if you are using a detergent pod or dispensing ball. Place the detergent pod or the dispensing ball directly among the laundry in the product.
- If you are using a liquid detergent, follow the directions under “Liquid detergent use” and hinge down the liquid detergent flap.

Choosing the Detergent type

Detergent type to be used depends on the washing programme, fabric type and colour.

- Use different detergents for coloured and white laundry.
- Wash your delicate clothes only with special detergents (liquid detergent, wool shampoo, etc.) intended solely for delicate clothes and on suggested programmes.
- When washing dark coloured clothes and quilts, it is recommended to use liquid detergent.
- Wash woollens on suggested programme with special detergent made specifically for woollens.
- Please review the programme descriptions part for suggested programme for different textiles.
- All recommendations about detergents are valid for selectable temperature range of programmes.



Only detergents, softeners and additives suitable for washing machines should be used.
Do not use soap powder.

Adjusting the Detergent Amount

The amount of detergent depends on the amount of laundry, how soiled it is and the water hardness.

- Do not exceed the recommended dosage values on the detergent packaging in order to eliminate excessive foam and poor rinsing problems, to save money and protect the environment.
- Use less detergent for lightly soiled or small amount of laundry.

Using Softeners

Put the softener in the softener compartment of the detergent drawer.

- Do not exceed the (>max<) level sign in the softener compartment.
- If the softener is thick, dilute with water before placing in the softener compartment.



WARNING

Do not use liquid detergents or other materials with cleaning properties unless they are intended for use in washing machines for softening the laundry.

Using Liquid Detergents

If the Product Has a Liquid Detergent Flap

- Hinge down the liquid detergent flap when you want to use liquid detergents. The flap will serve as a barrier for liquid detergent.
- Clean with water at its place or by removing from its place when it is necessary. Do not forget to place the flap in the main washing compartment (compartment 2) after cleaning.
- The flap should be up if you will use a powder detergent.

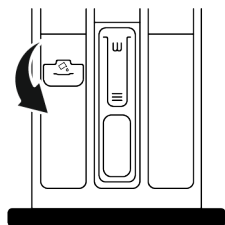

Use of Gel and Tablet Detergents

- If the detergent is fluid and there is no liquid detergent compartment in your product, place the gel detergent in the main washing detergent compartment in first water intake. If your product has a liquid detergent compartment, fill the compartment with detergent before starting the programme.
- If the gel detergent is not fluid or is in a capsule liquid tablet, place directly inside the drum before washing.
- Put the tablet detergent in the main washing compartment (compartment 2) or directly inside the drum before washing.

Using Starch

- Put in the liquid starch, powder starch or fabric dye in the softener compartment.
- Do not use softener and starch in the same washing programme simultaneously.
- Wipe the inside of the product with a damp and clean cloth after using starch.

Using Anti-Limescale

- When necessary, only use anti-limescale produced for washing machines.

Using Bleach and Decolourants

- Select a programme with pre-washing and add bleach at the start of pre-washing. Do not put detergent in the pre-wash compartment. As an alternative application, select a programme with additional rinsing and add the bleach while the product is receiving water to the detergent compartment in the first rinsing step.
- Do not mix and use bleach and detergent together.
- As bleach may cause skin irritation use only small amounts (1/2 tea cups - approximately 50 ml and rinse the laundry well.
- Do not pour bleach directly onto the laundry.
- Do not use bleach for coloured clothes.

- Select a programme with low temperature washing while using oxygen-based decolourants.
- Oxygen-based decolourants can be used together with detergents. However, if it does not have the same viscosity as the detergent, first place the detergent in

compartment no. "2" in the detergent drawer and wait for the product to rinse away the detergent during water intake. Add the decolourant to the same compartment while the product continues taking in water.

5.7 Tips for Efficient Washing

		Clothes			
		Light Colours and Whites	Colours	Black/Dark Colours	Delicates/Woolens/Silks
		(Recommended temperature range based on soil level: 40-90 °C)	(Recommended temperature range based on soil level: cool -40 °C)	(Recommended temperature range based on soil level: cool -40 °C)	(Recommended temperature range based on soil level: cool -30 °C)
Soiling Level	Heavily Soiled (difficult stains such as grass, coffee, fruits and blood.)	It may be necessary to pre-treat the stains or perform prewash. Powder and liquid detergents recommended for whites can be used at dosages recommended for heavily soiled clothes. It is recommended to use powder detergents to clean clay and soil stains and the stains that are sensitive to bleaches.	Powder and liquid detergents recommended for colours can be used at dosages recommended for heavily soiled clothes. It is recommended to use powder detergents to clean clay and soil stains and the stains that are sensitive to bleaches. Detergents which do not contain decolourant should be used.	Liquid detergents suitable for colours and black/dark colours can be used at doses recommended for heavily soiled clothes.	Prefer liquid detergents produced for delicate clothes. Woollen and silk clothes must be washed with special woollen detergents.
	Normally Soiled (For example, stains caused by body on collars and cuffs)	Powder and liquid detergents recommended for whites can be used at dosages recommended for normally soiled clothes.	Powder and liquid detergents recommended for colours can be used at dosages recommended for normally soiled clothes. Detergents which do not contain decolourant should be used.	Liquid detergents suitable for colours and black/dark colours can be used at doses recommended for moderately soiled clothes.	Prefer liquid detergents produced for delicate clothes. Woollen and silk clothes must be washed with special woollen detergents.
	Lightly Soiled (No visible stains exist.)	Powder and liquid detergents recommended for whites can be used at dosages recommended for lightly soiled clothes.	Powder and liquid detergents recommended for colours can be used at dosages recommended for lightly soiled clothes. Detergents which do not contain decolourant should be used.	Liquid detergents suitable for colours and black/dark colours can be used at doses recommended for lightly soiled clothes.	Prefer liquid detergents produced for delicate clothes. Woollen and silk clothes must be washed with special woollen detergents.

5.8 Displayed Programme Duration

You can view the programme duration on the display of your product while selecting a programme. Depending on the amount of laundry you have loaded into your product, foaming, unbalanced load conditions, fluctuations in power supply, water pressure

and programme settings, the programme duration is automatically adjusted while the programme is running.

SPECIAL CASE: At programme start of Cottons and Cotton Eco programmes, display shows the duration of half load. It is the most common use case. After programme

starts, in 20-25 minutes actual load is detected by the product. And if the detected load is higher than half load; washing programme will be adjusted accordingly and

programme duration increased automatically. You can follow this change on the display.

6 Operating the Product



Please read the "Safety Instructions" section first!

6.1 Control Panel

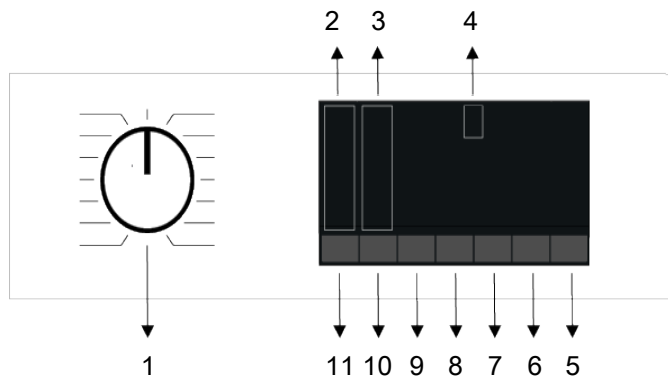

- 1 Programme Selection Button
- 3 Spin Level Indicator Lights
- 5 Start/Pause Button
- 7 Auxiliary Function Button 3
- 9 Auxiliary Function Button 1
- 11 Temperature Setting Button

- 2 Temperature Level Indicator Lights
- 4 Display
- 6 End Time Setting Button
- 8 Auxiliary Function Button 2
- 10 Spin Speed Adjustment Button

6.2 Symbols on the Display

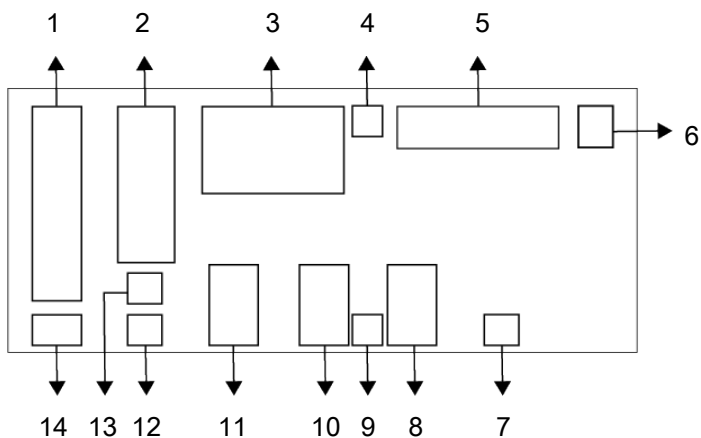

- | | |
|------------------------------------|------------------------------------|
| 1 Temperature Indicator | 2 Spin Speed Indicator |
| 3 Duration Information | 4 Door Lock Is Engaged Symbol |
| 5 Programme Follow-up Indicator | 6 No Water Indicator |
| 7 Delayed Start Enabled Indicator | 8 Auxiliary Function Indicators 3 |
| 9 Child Lock Enabled symbol | 10 Auxiliary Function Indicators 2 |
| 11 Auxiliary Function Indicators 1 | 12 No Spin Indicator |
| 13 Rinse Hold Indicator | 14 Cold Water indicator |



The visuals used for product description in this section are schematic and may not match exactly with the features of your product.

6.3 Programme Table

Program	Maximum load (kg)
Cotton	9
Synthetic	4
ColourCare	4,5
Gentle/Wool	2

Rapid 28'/14'	9
Rapid 28'/14' + Rapid/Intensive	2
20°C	9
Full Load 45'	9
Machine Clean	-
Eco 40-60 ***	9
Mixed	4
Intensive	9
SteamCare	-
Anti Stain	4,5

Consumption values (EN)								
	Temperature Selection °C	Spin Speed (rpm)	Capacity (kg)	Program duration (h:min)	Energy consumption (kWh/cycle)	Water consumption (litres/cycle)	Laundry temperature (°C)	% Of re-maining humidity (%)
Eco 40-60	40***	1351	9,0	3:48	0,490	60,0	25	50,7
	40***	1351	4,5	2:53	0,366	48,0	26	54,9
	40***	1351	2,5	2:53	0,206	40,0	22	56,0
Cotton	20	1400	9,0	04:00	0,750	95,0	20	53,9
	60	1400	9,0	03:40	2,000	98,0	60	53,9
Synthetic	40	1200	4,0	02:20	1,100	74,0	40	40,0
Rapid 28'/14'	30	1400	9,0	00:28	0,250	75,0	23	62,0
The consumption values given for programs other than the Eco 40-60 program are indicative only.								

- : See programme description for maximum load.

***: Eco 40-60 program 40 ° C temperature selection is the test program according to EU regulation EU/2019/2014 and EN 60456:2016/A11:2020 standard.

i Before using for the first time, re-view the Installation section of the user manual.

Water and energy consumption may vary depending on water pressure, hardness and temperature, ambient temperature, laundry type and quantity, auxiliary function selection, spin speed and changes in mains voltage.

The selection methods of auxiliary functions can be changed by the manufacturer. New selection methods can be added or existing ones can be removed.

The spin speed of your product may vary depending on the programme. The spin speed cannot exceed the maximum spin speed of your washing machine.

The amount of noise and moisture varies depending on the spin speed. When you select a higher spin speed, the laundry will contain less moisture at the end of the programme but there the noise level.

i When you select a programme, you can see the estimated washing duration on the display. The estimated washing duration may vary by up to 1.5 hours depending on the amount of laundry. The actual time will be displayed once the programme starts.

Always select the lowest suitable temperature. For energy efficiency, choose the lowest suitable temperature. Longer, low-temperature washes are often the most efficient.

6.4 Programme Selection

1. According to the "Programme table", determine the programme suitable for the type, quantity and dirt level of the laundry.

i Programs are limited to the highest spin speed suitable for the fabric type.

When choosing the program you will use, always take into consideration the fabric type, color, degree of soiling and allowed water temperature.

2. Select the desired program using the Program Selection button.

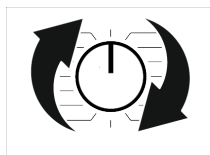

6.5 Programmes

• FabricCare

This technology shortens the washing cycle by ensuring effective use of detergent through a specially designed drum and paddle structure combined with advanced washing algorithms. It particularly enhances washing performance while preserving the structure of delicate fabrics. Washing machines with paddle designs focused on time efficiency help reduce washing time while also preserving the quality of the laundry.

• Eco 40-60

The Eco 40-60 program is suitable for washing normally soiled cotton laundry labeled to be washable together at 40 °C or 60 °C. This programme is the standard test programme according to the EU environmentally friendly design and energy labelling regulations.

Although this programme washes longer than other washing programmes, it is more efficient in terms of energy and water consumption. Actual water temperature may be different from the stated wash temperature. When you load the product with less laundry (e.g. ½ capacity or less), cycle duration may automatically get shorter. In this way, energy and water consumption would be much less.

• Full Load 45'

Use this program to wash your lightly soiled cotton laundry in a short time.

• Cotton

You can wash your durable cotton laundry (sheets, bedlinen, towels, bathrobes, underwear etc.) in this programme. When the quick wash function button is pressed, programme duration becomes notably shorter but effective washing performance is ensured with intense washing movements. If the quick wash function is not selected, effective washing and rinsing performance is ensured for your heavily soiled laundry.

• Synthetic

Use this programme to wash your clothes such as t-shirts, blouses, synthetic/cotton-blend fabrics etc. The quick wash function shortens the programme duration significantly and ensures effective washing performance for lightly-soiled laundry. The quick wash function is not suitable for heavily-soiled laundry.

If your product does not have a specific curtains programme, you can use this programme. Wash your curtains at 40 °C maximum and with a spin speed up to 800 rpm.

• Gentle/Wool

Use to wash your woollen/delicate laundry. Select the appropriate temperature complying with the tag of your clothes. Your laundry will be washed with a very gentle washing action in order not to damage the clothes.

• Intensive

Applying a steam step at the beginning of the programme allows to soften the dirt easily.

Use this programme for your laundry (baby clothes, bed sheets, bedlinen, underwear, etc. cotton items) that requires an anti-allergic and hygienic washing at high temperature with intensive and long washing cycle. The high level of hygiene is ensured thanks to the steam application before the programme, long heating duration and additional rinsing step.

• Spin + Drain

You can use this program to remove the water on the garment/inside the product.

• Rinse

Use when you want to rinse or starch separately.

• SteamCare

Use this programme to reduce the creases and ironing times of a small amount of unspotted cotton, synthetic or mixed laundry.



This is not a washing programme. Do not add chemicals such as detergent, bleach, stain remover, etc. to the detergent drawer during this program.

• Rapid 28'/14'

Use this programme to wash your lightly soiled or unspotted cotton clothes in a short time but not for towels or heavy cottons. The programme duration can be reduced down to 14 minutes when the quick wash function is selected. When the quick wash function is selected, maximum 2 (two) kg of laundry must be washed.

• Machine Clean

Regularly clean (once every 1 to 2 months) the drum for ensuring the required hygiene. Steam is applied before the programme to soften the residues in the drum. Turn on the programme when the product is completely empty. For better results, use powder anti-limescale (drum cleaning materials) suitable for washing machines when the powder detergent function is selected. Leave the loading door half closed after the programme ends for the inside of the product to dry.



This is not a washing programme. This is a maintenance programme. Do not turn this programme on when there is something inside the product. When you attempt to operate, the product automatically senses that there is load inside, and may quit or resume the programme as per the model of your product. An effective cleaning is not achieved if the programme is resumed.

• **Mixed**

Use to wash your cotton and synthetic laundry items together without sorting them.

• **20°C**

You can wash your lightly soiled cotton laundry in this program.

• **ColourCare**

Use to wash your medium dirty and durable cotton/synthetic laundry. Thanks to the washing algorithm specially developed for the program, effective washing is ensured without exposing the laundry to high temperatures.

• **Anti Stain**

The product has a special stain programme which enables the removal of different types of stains in the most effective way. Use this programme only for durable colourfast cotton laundry. Do not wash delicate and non-colourfast clothes and laundry in this programme. Before washing, garment tags should be checked (recommended for cotton shirts, trousers, shorts, t-shirts, baby clothes, pyjamas, aprons, table clothes, bed sheets, duvet covers, pillowcases, bath-beach towels, towels, socks, cotton underwear that are suitable for washing at high temperature and long time).

In the automatic stain programme, you can wash 24 types of stains divided into three different groups according to quick function selection. Depending on the selected stain group, a special washing programme

for which duration of rinse hold, washing action, washing and rinsing duration are modified.

Below you can find the soil groups that can be selected with the “Quick/Intensive” setting button:

When “Intense” is selected;

Sweat, collar dirt, food, mayonnaise, salad dressing, make-up, machine oil, baby food.

When “Quick/Intense” is not selected;

Blood, chocolate, pudding, grass, mud, eggs, butter, curry.

When “Quick” is selected;

Tea, coffee, juice, ketchup, red wine, cola, jam, coal

1. Select the stain programme.
2. Select the stain you want to clean by locating it in the groups above and selecting the related group with the Quick/Intense auxiliary function button.
3. Read the garment tag carefully and ensure that correct temperature and spin speed are selected.

6.6 Temperature Selection

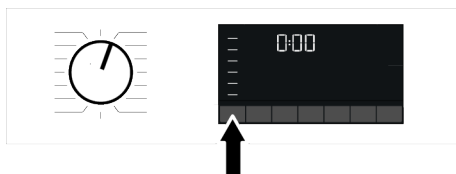

Whenever a new programme is selected, the recommended temperature for the programme appears on the temperature indicator. It is possible that the recommended temperature value is not the maximum temperature that can be selected for the current programme.

Press the Temperature Adjustment button to change the temperature. Temperature decreases gradually.



No change can be made in programmes where temperature adjustment is not allowed.

You can also change the temperature after the washing starts. This change can be made if the only washing steps allow it.

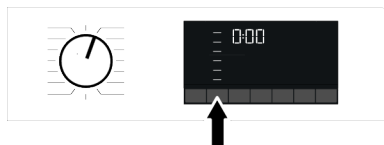

 If you scroll to cold wash option and press Temperature Adjustment button again, the recommended maximum temperature for the selected programme appears on the display. Press the Temperature Adjustment button again to decrease the temperature.

6.7 Spin Speed Selection



Whenever a new programme is selected, the recommended spin speed of the selected programme is displayed on the Spin Speed indicator. It is possible that the recommended spin speed value is not the maximum spin speed that can be selected for the current programme.

Press the Spin Speed Adjustment button to change the spin speed. Spin speed decreases gradually.

Then, depending on the model of the product, "Rinse Hold " and "No Spin " options appear on the display.

If you are not going to unload your laundry immediately after the programme completes, you can use Rinse Hold function in order to prevent your laundry from getting wrinkled when there is no water in the machine.

This function holds the laundry in the final rinsing water. If you want to spin your laundry after the Rinse Hold function:

1. Adjust the Spin Speed.
2. Press Start/Pause button. The programme will resume. Machine drains the water and spins the laundry.

If you want to drain the water at the end of the programme without spinning, use No Spin function.

 No change can be made in programmes where spin speed adjustment is not allowed.

You can change the spin speed after the washing starts if the washing steps allow it. Changes cannot be made if the steps do not allow it.

Rinse Hold

If you are not going to unload your clothes immediately after the programme completes, you can use rinse hold function to keep your laundry in the final rinsing water in order to prevent them from getting wrinkled when there is no water in the machine. Press Start/Pause button after this process if you want to drain the water without spinning your laundry. Programme will resume and complete after draining the water.

If you want to spin the laundry held in water, adjust the Spin Speed and press Start/Pause button. The programme will resume. Water is drained, laundry is spun and the programme is completed.

6.8 Auxiliary Function Selection

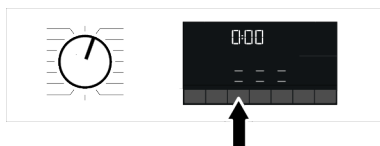

Before starting the program, select the desired auxiliary functions. When a program is selected, the icons for the selected auxiliary function symbol will light up.



When an auxiliary function button that cannot be selected with the current program is pressed, the washing machine emits a warning sound.

Some functions cannot be selected simultaneously. If a second auxiliary function that is incompatible with the first selected auxiliary function is selected before starting the machine, the first selected function will be canceled and the last selected auxiliary function will remain selected.

An auxiliary function that is not compatible with the program cannot be selected.

Some programs have auxiliary functions that must work together.

These functions cannot be disabled.

6.8.1 Auxiliary Functions

• Rapid/Intensive

You can shorten or extend the programme duration with this function. Depending on the programme selection, there may be differences in time increases and decreases. In case the FAST or INTENSIVE LED is not lit, the appropriate programme duration is shown for your normally soiled clothes/laundry.

Depending on the programme selection, the Intensive feature can be selected automatically. In this case, the Intensive LED on the panel will be lit. You can use the Intensive selection to achieve a better washing performance when washing heavily soiled laundry.

You can reduce the time for your lightly soiled laundry by pressing the Fast/Intensive button in the programmes which come with intense being selected. When you press the button once, the LED will turn off and you will reach the appropriate programme duration for your normally soiled clothes/laundry. When you press the same button a second time, the fast LED will light up, the time will decrease a little and it will

show the minimum programme duration, which is suitable for your less soiled laundry. The duration of programmes may shorten by 50% when this function is selected. Thanks to optimized washing steps, high mechanical agility and optimal water consumption, high washing performance is achieved despite the shorter duration.

• Pet Hair Care

This function helps to remove pet hair that is on your garments more effectively.

When you select this function, Prewash and Extra Rinse programmes are added to the normal programme. Thus, washing is performed with more water and the pet hair is removed more effectively.

• Steam

This function helps to reduce the creases in your cotton, synthetic and mixed clothes, shorten the ironing time and remove the dirt by softening.

* Under conditions where the steam function is applied at the end of the programme, your laundry may be warmer at the end of the washing. This is expected within the programme working conditions.



When you activate the steam function, do not use liquid detergent if there is no liquid container or liquid detergent dosing feature. There is the risk of staining of the clothes.

6.8.2 Functions/Programmes Selected by Pressing the Function Buttons for 3 Seconds

• Prewash 3"

This function can be selected by pressing and holding the related auxiliary function button for 3 seconds.

A Prewash is only worthwhile for heavily soiled laundry. Not using the Prewash will save energy, water, detergent and time.

• Child Lock

Use Child Lock function to prevent children from tampering with the product. Thus you can avoid any changes in a running programme.

 You can switch on and off the product with On / Off button when the Child Lock is active. When you switch on the product again, programme will resume from where it has stopped.

When the Child Lock is enabled, an audio warning will be given if the buttons are pressed. Audio warning will be cancelled if the buttons are pressed five times consecutively.

To activate the child lock:

Press and hold the related auxiliary function button for 3 seconds. After the countdown as "3-2-1" on the display is over, Child Lock symbol appears on the display. When this warning is displayed, you can release the Auxiliary Function button 3.

To deactivate the child lock:

Press and hold the related auxiliary function button for 3 seconds. After the countdown as "3-2-1" on the display is over, Child Lock symbol disappears.

6.9 End Time

Time display

When the end time function is selected, the time remaining until the program starts is displayed in hour format such as 1h, 2h, and the time remaining for the program to be completed after it starts is displayed in hour and minute format such as 01:30.

 Programme duration may vary depending on water pressure, water hardness and temperature, ambient temperature, laundry type and amount, auxiliary function selection and changes in mains voltage. After the end time function is activated, the machine goes into standby mode and some LEDs on the display are turned off. If any user input occurs, the LEDs will turn back on.

The program's end time can be set for up to 24 hours using the End Time Adjustment function. The time displayed after pressing the End Time button is the estimated end time of the program. If the End Time is set, the End Time indicator will illuminate.

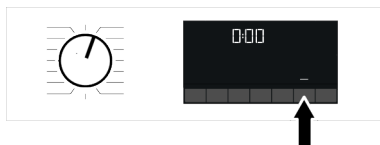

In order for the End Time function to be activated and the program to end at the end of the specified time, the Start/Pause button must be pressed after the time setting.

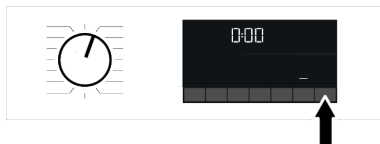

If you want to cancel the End Time function, turn the knob to the on or off position.

 When you activate the End Time function, do not add liquid detergent to powder detergent compartment no. 2. There is a risk of stains on the laundry.

1. Open the loading door, place the laundry and add detergent etc.
2. Select the washing program, temperature, spin speed and auxiliary functions if necessary.

3. Press the End Time button to set the desired end time. The End Time indicator will light up.
4. Press the Start/Pause button. The countdown begins.

 Additional laundry can be added to the machine during the End Time countdown. At the end of the countdown, the End Time indicator turns off, washing begins, and the duration of the selected program is displayed.

6.10 Starting the Program

1. Press the Start/Pause button 1 second to start the program.

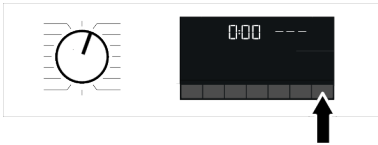

2. The Start/Pause button's dim light now becomes steady, indicating that the program has started.
3. The loading door is locked. After the loading door is locked, the door lock symbol appears on the screen.
4. The program follow-up indicator lights on the screen show the current program step.

6.11 Loading Door Lock

There is a locking system on the loading door of the machine that prevents opening of the loading door in cases when the water level is unsuitable.

"Door Locked" symbol appears on the display when the loading door is locked.



Opening the loading door in case of power failure:

 In case of power failure, you can use the loading door emergency handle under the pump filter cap to open the loading door manually.

 To avoid any water overflow before opening the loading door, make sure there is no water left inside the product.

1. Turn off and unplug the product.
2. Open the pump filter lid.

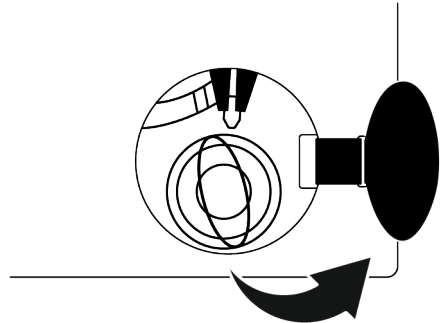

3. Pull down the loading door emergency handle with a tool and release. Then open the loading door.
4. If the loading door does not open then repeat the previous step.

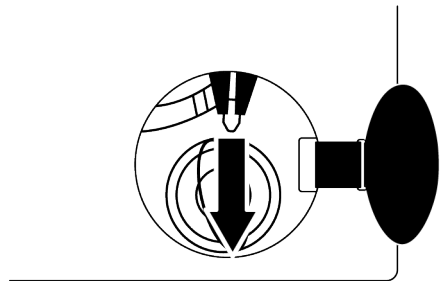

6.12 Changing Selections After Program Starts

Adding laundry after the program has started:

When you press the Start/Pause button, if the water level in the machine is appropriate, the door lock is deactivated and the

door opens for you to add laundry. When the door lock is deactivated, the door lock symbol on the screen disappears. After adding laundry, close the door and press the Start/Pause button again to continue washing.

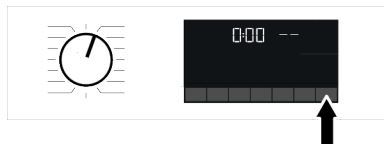

If the water level in the machine is insufficient when you press the Start/Pause button, the door lock cannot be deactivated and the door lock icon on the display will continue to appear.

i If the water temperature inside the machine is above 50°C, you cannot disable the door lock for safety reasons (even if the water level is suitable).

Putting the machine into pause mode:

To pause the washing machine, press and hold the Start/Pause button for 1 second. The pause symbol will flash on the display.

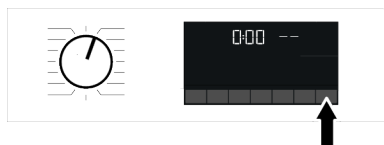

Changing the program selection after the program has started:

If Child Lock is not active, the program can be changed while the current program is running. This will cancel the current program.

i The selected program starts over.

7 Maintenance and Cleaning

i Please read the "Safety Instructions" section first!

Changing auxiliary function, speed and temperature settings:

Depending on the step the program has reached, you can disable or enable auxiliary functions. See "Auxiliary function selection" You can also change the spin speed and temperature settings. See "Spin speed selection" and "Temperature selection".

i If the water temperature inside the machine is high or the water level is above the cover line, the loading door will not open.

6.13 Cancelling the Programme

The programme is cancelled when programme selection knob is turned to a different programme or product is turned off and on again using the programme selection knob.

i If you turn the programme selection knob when the Child Lock is enabled, the programme will not be cancelled. You should cancel the Child Lock first.

If you want to open the loading door after you have cancelled the programme but if it is not possible to open the loading door since the water level in the product is above the loading door baseline, then turn the Programme Selection knob to Pump+Spin programme and drain the water in the product.

6.14 End of Programme

End symbol appears on the display when the programme is completed.

If you do not press any button for 10 minutes, the product will switch to OFF mode. Display and all indicators are turned off.

Completed programme steps will be displayed if you press On/Off button.

Service life of your product extends and frequently experienced problems will be reduced if it is cleaned at regular intervals.

7.1 Cleaning the Detergent Drawer

Clean the detergent drawer at regular intervals (once every 4 to 5 wash) as mentioned below to prevent accumulation of powder detergent.

Clean the syphon if excess amounts of water and fabric softener mixture remains in the softener compartment.

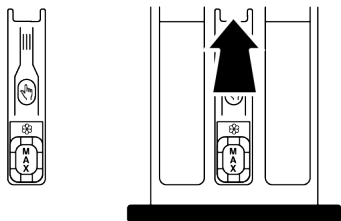

1. Press the marked part of the syphon within the softener compartment and then pull the drawer towards yourself to take it out.
2. Lift and remove the syphon from behind as shown.
3. Rinse drawer and syphon in the sink with plenty of warm water. Use gloves or suitable brush to prevent contact of residues in the drawer with your skin.
4. Firmly fit the syphon and the drawer back after cleaning.

7.2 Cleaning the Loading Door and the Drum

For products with drum cleaning programme, please see the Operating the product section.



Repeat Drum Cleaning process in every 2 months.

NOTICE: Use an anti-limescale suitable for the washing machines.

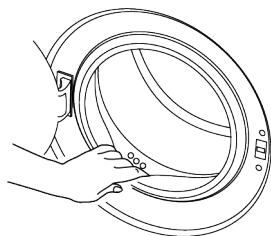

After every washing make sure that no foreign substance is left in the product.

If the holes on the door gasket shown in the figure is blocked, open the holes using a toothpick.

Foreign metal substances will cause rust stains in the drum. Clean the stains on the drum surface by using cleaning agents for stainless steel.

Never use steel wool or wire wool. These will damage the painted, chrome coated and plastic surfaces.

We recommend you to wipe the door gasket with a dry and clean cloth at the end of the programme. This will remove residues on the door gasket in your product and prevent formation of malodours.

7.3 Cleaning the Body and Control Panel

Wipe the body of the product with soapy water or non-corrosive mild gel detergents as necessary, and dry with a soft cloth.

Use only a soft and damp cloth to clean the control panel. Do not use cleaning products that contain bleach

7.4 Cleaning the Water Intake Filters

There is a filter at the end of each water intake valve at the rear of the product and also at the end of each water intake hose where they are connected to the tap. These filters prevent foreign substances and dirt in the water to enter the product. Filters should be cleaned if they are dirty.

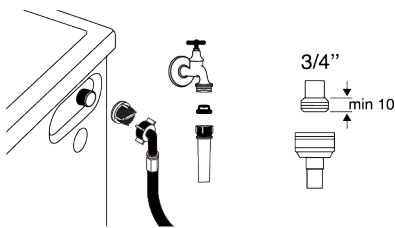

1. Close the taps.
2. Remove the nuts of the water intake hoses to access the filters on the water intake valves and clean them with an ap-

appropriate brush. If the filters are too dirty, remove them from their places with a pliers and clean in this way.

3. Take out the filters on the flat ends of the water intake hoses together with the gaskets and clean thoroughly under running water.
4. Replace the gaskets and filters carefully and tighten their nuts by hand.

7.5 Draining Remaining Water and Cleaning the Pump Filter

The filter system in your product prevents solid items such as buttons, coins and fabric fibres clogging the pump impeller during draining of washing water. Thus, the water will be drained without any problem and the service life of the pump will extend.

If the product fails to drain water inside it, the pump filter is clogged. Filter must be cleaned whenever it is clogged or in every 3 months. Water must be drained off first to clean the pump filter.

In addition, prior to transporting the product (e.g., when moving to another house) water should be drained completely.



NOTE:

Foreign substances left in the pump filter may damage your product or may cause noise problem.

If you live in areas prone to frost, remember to turn off the water tap, disconnect the main hose, and drain the water from the product when it's not in use.

After each use, turn off the tap to which the mains hose is connected.

In order to clean the dirty filter and drain the water:

1. Unplug the product to cut off the supply power.



Temperature of the water inside the product may rise up to 90 °C. To avoid the risk of scalding, clean the filter after the water inside the product is cooled down.

2. Open the filter cover.

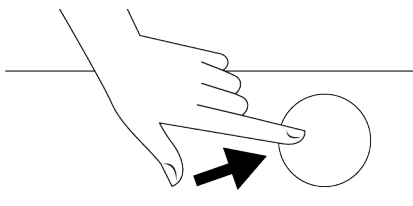

3. Follow the below procedures in order to drain water.

If the product does not have an emergency water draining hose, in order to drain the water:



- Place a large container at the end of the hose to collect the water from the filter.
 - When the pump filter starts leaking water loosen it by turning (opposite clockwise). Fill the running water to the container you placed in front of the filter. Keep a cloth ready to clean the water that may spill.
 - Completely turn and remove the pump filter when the water in the product leaks out.
1. Clean any residues inside the filter as well as fibres, if any, around the pump impeller region.
 2. Replace the filter.
 3. If the filter cap is composed of two pieces, close the filter cap by pressing on the tab. If it is one piece, seat the tabs in the lower part into their places first, and then press the upper part to close.

8 Troubleshooting



Please read the "Safety Instructions" section first!

Programmes do not start after the loading door is closed.

- Start / Pause / Cancel button is not pressed. >>> Press Start / Pause / Cancel button.
- It may be difficult to close the loading door in case of excessive loading. >>> Reduce the amount of laundry and make sure that the loading door is closed properly.

Programme cannot be started or selected.

- The product has switched to self-protection mode due to a supply problem (line voltage, water pressure, etc.). >>> Depending on the product model, select another program by turning the Program Selection button or pressing and holding the On/Off button for 3 seconds to cancel the program. Previous programme will be cancelled. See Cancelling the Programme [► 30]

Water inside the product.

- Some water has remained in the product due to the quality control processes in the production. >>> This is not a failure; water is not harmful to the product.

The product does not take water in.

- Tap is turned off. >>> Turn on the taps.
- Water inlet hose is bent. >>> Flatten the hose.
- Water inlet filter is clogged. >>> Clean the filter.
- Loading door is not closed. >>> Close the door.

The product does not drain water.

- Water drain hose is clogged or twisted. >>> Clean or flatten the hose.
- Pump filter is clogged. >>> Clean the pump filter.

Product vibrates or makes noise.

- Product is standing unbalanced. >>> Adjust the stands to balance the product.

- A hard substance has entered into the pump filter. >>> Clean the pump filter.
- Transportation safety bolts are not removed. >>> Remove the transportation safety bolts.
- Laundry quantity in the product is too little. >>> Add more laundry to the product.
- Excessive laundry is loaded in the product. >>> Take out some of the laundry from the product or distribute the load by hand to balance it homogeneously in the product.
- Product is leaning on a rigid item. >>> Make sure that the product is not leaning on anything.

There is water leaking from the bottom of the product.

- Water drain hose is clogged or twisted. >>> Clean or flatten the hose.
- Pump filter is clogged. >>> Clean the pump filter.

Product stopped shortly after the programme started.

- Product has stopped temporarily due to low voltage. >>> Product will resume running when the voltage restores to the normal level.

Product directly drains the water it takes in.

- Draining hose is not at adequate height. >>> Connect the water draining hose as described in the user manual.

No water can be seen in the product during washing.

- Water is inside the invisible part of the product. >>> This is not a failure.

Loading door cannot be opened.

- Loading door lock is activated because of the water level in the product. >>> Drain the water by running the Pump or Spin programme.
- Product is heating up the water or it is at the spinning cycle. >>> Wait until the programme completes.

- Loading door may be stuck because of the pressure it is subjected to. >>> Hold the handle and push and pull the loading door to release and open it.
- If there is no power, loading door of the product will not open. >>> To open the loading door, open the pump filter cap and pull down the emergency handle positioned at the rear side of the said cap. See Loading Door Lock [▶ 29]

Washing takes longer than specified in the user manual. (*)

- Water pressure is low. >>> Product waits until taking in adequate amount of water to prevent poor washing quality due to the decreased amount of water. Therefore, the washing time extends.
- Voltage is low. >>> Washing time is prolonged to avoid poor washing results when the supply voltage is low.
- Input temperature of water is low. >>> Required time to heat up the water extends in cold seasons. Also, washing time can be lengthened to avoid poor washing results.
- Number of rinses and/or amount of rinsing water have increased. >>> Product increases the amount of rinsing water when good rinsing is needed and adds an extra rinsing step if necessary.
- Excessive foam has occurred and automatic foam absorption system has been activated due to too much detergent usage. >>> Use recommended amount of detergent.

Programme duration does not countdown. (On models with display) (*)

- Timer may stop during water intake. >>> Timer indicator will not countdown until the product takes in adequate amount of water. The product will wait until there is sufficient amount of water to avoid poor washing results due to lack of water. Timer indicator will resume countdown after this.
- Timer may stop during heating step. >>> Timer indicator will not countdown until the product reaches the selected temperature.

- Timer may stop during spinning step. >>> Automatic unbalanced load detection system is activated due to the unbalanced distribution of the laundry in the product.

Programme duration does not countdown. (*)

- There is unbalanced load in the product. >>> Automatic unbalanced load detection system is activated due to the unbalanced distribution of the laundry in the product.

Product does not switch to spinning step. (*)

- There is unbalanced load in the product. >>> Automatic unbalanced load detection system is activated due to the unbalanced distribution of the laundry in the product.
- The product will not spin if water is not drained completely. >>> Check the filter and the draining hose.
- Excessive foam has occurred and automatic foam absorption system has been activated due to too much detergent usage. >>> Use recommended amount of detergent.

Washing performance is poor: Laundry turns gray. ()**

- Insufficient amount of detergent has been used over a long period of time. >>> Use the recommended amount of detergent appropriate for water hardness and the laundry.
- Washing has been made at low temperatures for a long time. >>> Select the proper temperature for the laundry to be washed.
- Insufficient amount of detergent is used with hard water. >>> Using insufficient amount of detergent with hard water causes the soil to stick on the cloth and this turns the cloth into gray in time. It is difficult to eliminate graying once it happens. Use the recommended amount of detergent appropriate for water hardness and the laundry.

- Excessive amount of detergent is used. >>> Use the recommended amount of detergent appropriate for water hardness and the laundry.

Washing performance is poor: Stains persist or the laundry is not whitened. ()**

- Insufficient amount of detergent is used. >>> Use the recommended amount of detergent appropriate for water hardness and the laundry.
- Excessive laundry is loaded in. >>> Do not overload the product. Load with amounts recommended in the "Programme table".
- Wrong programme and temperature were selected. >>> Select the proper programme and temperature for the laundry to be washed.
- Wrong type of detergent is used. >>> Use original detergent appropriate for the product.
- Excessive amount of detergent is used. >>> Put the detergent in the correct compartment. Do not mix the bleaching agent and the detergent with each other.

Washing performance is poor: Oily stains appeared on the laundry. ()**

- Regular drum cleaning is not applied. >>> Clean the drum regularly. For this procedure, see Cleaning the Loading Door and the Drum [► 31]

Washing performance is poor: Clothes smell unpleasantly. ()**

- Odours and bacteria layers are formed on the drum as a result of continuous washing at lower temperatures and/or in short programmes. >>> Leave the detergent drawer as well as the loading door of the product ajar after each washing. Thus, a humid environment favourable for bacteria cannot occur in the product.

Colour of the clothes faded. ()**

- Excessive laundry was loaded in. >>> Do not load the product in excess.
- Detergent in use is damp. >>> Keep detergents closed in an environment free of humidity and do not expose them to excessive temperatures.

- A higher temperature was selected. >>> Select the proper programme and temperature according to the type and soiling degree of the laundry.

The product does not rinse well.

- The amount, brand and storage conditions of the detergent used are inappropriate. >>> Use a detergent appropriate for the product and your laundry. Keep detergents closed in an environment free of humidity and do not expose them to excessive temperatures.
- Detergent was put in the wrong compartment. >>> If detergent is put in the prewash compartment although prewash cycle is not selected, the product can take this detergent during rinsing or softener step. Put the detergent in the correct compartment.
- Pump filter is clogged. >>> Check the filter.
- Draining hose is folded. >>> Check the drain hose.

Laundry became stiff after washing. ()**

- Insufficient amount of detergent is used. >>> Using insufficient amount of detergent for the water hardness can cause the laundry to become stiff in time. Use appropriate amount of detergent according to the water hardness.
- Detergent was put in the wrong compartment. >>> If detergent is put in the prewash compartment although prewash cycle is not selected, the product can take this detergent during rinsing or softener step. Put the detergent in the correct compartment.
- Detergent was mixed with the softener. >>> Do not mix the softener with detergent. Wash and clean the drawer with hot water.

Laundry does not smell like the softener. ()**

- Detergent was put in the wrong compartment. >>> If detergent is put in the prewash compartment although prewash cycle is not selected product, the can take this detergent during rinsing or

softener step. Wash and clean the drawer with hot water. Put the detergent in the correct compartment.

- Detergent was mixed with the softener. >>> Do not mix the softener with detergent. Wash and clean the drawer with hot water.

Detergent residue in the detergent drawer. ()**

- Detergent was put in wet drawer. >>> Dry the detergent drawer before putting in detergent.
- Detergent has gotten damp. >>> Keep detergents closed in an environment free of humidity and do not expose them to excessive temperatures.
- Water pressure is low. >>> Check the water pressure.
- The detergent in the main wash compartment got wet while taking in the prewash water. Holes of the detergent compartment are blocked. >>> Check the holes and clean if they are clogged.
- There is a problem with the detergent drawer valves. >>> Call the Authorised Service Agent.
- Detergent was mixed with the softener. >>> Do not mix the softener with detergent. Wash and clean the drawer with hot water.
- Regular drum cleaning is not applied. >>> Clean the drum regularly. For this procedure, see Cleaning the Loading Door and the Drum [► 31]

Too much foam forms inside the product. ()**

- Improper detergents for the product is used. >>> Use detergents appropriate for the product.
- Excessive amount of detergent is used. >>> Use only sufficient amount of detergent.
- Detergent was stored under improper conditions. >>> Store detergent in a closed and dry location. Do not store in excessively hot places.

- Some meshed laundry such as tulle may foam too much because of their texture. >>> Use smaller amounts of detergent for this type of item.
- Detergent was put in the wrong compartment. >>> Make sure you place the detergent in the appropriate compartment.
- Softener is being taken early by the product. >>> There may be problem in the valves or in the detergent drawer. Call the Authorised Service Agent.

Foam is overflowing from the detergent drawer.

- Too much detergent is used. >>> Mix 1 tablespoonful softener and ½ l water and pour into the main wash compartment of the detergent drawer. >>> Put detergent into the product suitable for the programmes and maximum loads indicated in the "Programme table". When you use additional chemicals (stain removers, bleaches and etc.), reduce the amount of detergent.

Laundry remains wet at the end of the programme. (*)

- Excessive foam has occurred and automatic foam absorption system has been activated due to too much detergent usage. >>> Use recommended amount of detergent.

(*) The product does not switch to spinning step when the laundry is not evenly distributed in the drum to prevent any damage to the product and to its surrounding environment. Laundry should be rearranged and re-spun.

(**) Regular drum cleaning is not applied. Clean the drum regularly. See Cleaning the Loading Door and the Drum [► 31]



If you cannot eliminate the problem although you follow the instructions in this section, consult your dealer or the Authorised Service Agent. Never try to repair a nonfunctional product yourself.

9 DISCLAIMER

Some (simple) failures can be adequately handled by the end-user without any safety issue or unsafe use arising, provided that they are carried out within the limits and in accordance with the following instructions (see the “Self-Repair” section).

Therefore, unless otherwise authorized in the “Self-Repair” section below, repairs shall be addressed to registered professional repairers in order to avoid safety issues. A registered professional repairer is a professional repairer that has been granted access to the instructions and spare parts list of this product by the manufacturer according to the methods described in legislative acts pursuant to Directive 2009/125/EC.

However, only the service agent (i.e. authorized professional repairers) that you can reach through the phone number given in the user manual/warranty card or through your authorized dealer may provide service under the guarantee terms. Therefore, please be advised that repairs by professional repairers (who are not authorized by Hotpoint) shall void the guarantee.

Self-Repair

Self-repair can be done by the end-user with regard exclusively to the following spare parts: door, door hinge and seals, other seals, door locking assembly and plastic peripherals such as detergent dispensers (an updated list is also available in parts-selfservice.europeanappliances.com as of 1st of March 2021)

Moreover, to ensure product safety and to prevent risk of serious injury, the mentioned self-repair shall be done following the instructions in the user manual for self-repair or which are available in parts-selfservice.europeanappliances.com For your safety, unplug the product before attempting any self-repair.

Repair and repair attempts by end-users for parts not included in such list and/or not following the instructions in the user manuals for self-repair or which are available in parts-selfservice.europeanappliances.com , might give raise to safety issues not attributable to parts-selfservice.europeanappliances.com , and will void the warranty of the product.

Therefore, it is highly recommended that end-users refrain from the attempt to carry out repairs falling outside the mentioned list of spare parts, contacting in such cases authorized professional repairers or registered professional repairers. On the contrary, such attempts by end-users may cause safety issues and damage the product and subsequently cause fire, flood, electrocution and serious personal injury to occur.

By way of example, but not limited to, the following repairs must be addressed to authorized professional repairers or registered professional repairers: motor, pump assembly, main board, motor board, display board, heaters etc.

The manufacturer/seller cannot be held liable in any case where end-users do not comply with the above

The spare part availability of the washing machine or washer-dryer that you purchased is 10 years. During this period, original spare parts will be available to operate the washing machine or washer-dryer properly.

