

**RMHDT90SS/ - RMHDT100SS/ - RMHDT110SS/**

**Instructions Manual**

**[www.rangemaster.co.uk](http://www.rangemaster.co.uk)**

# INDEX

---

RECOMMENDATIONS AND SUGGESTIONS .....	3
CHARACTERISTICS .....	4
INSTALLATION.....	5
USE .....	8
MAINTENANCE .....	9

# RECOMMENDATIONS AND SUGGESTIONS

⚠ The Instructions for Use apply to several versions of this appliance. Accordingly, you may find descriptions of individual features that do not apply to your specific appliance.

## INSTALLATION

- The manufacturer will not be held liable for any damages resulting from incorrect or improper installation.
- The minimum safety distance between the cooker top and the extractor hood is 650 mm (some models can be installed at a lower height, please refer to the paragraphs on working dimensions and installation).
- Check that the mains voltage corresponds to that indicated on the rating plate fixed to the inside of the hood.
- For Class I appliances, check that the domestic power supply guarantees adequate earthing.

Connect the extractor to the exhaust flue through a pipe of minimum diameter 120 mm. The route of the flue must be as short as possible.

- Do not connect the extractor hood to exhaust ducts carrying combustion fumes (boilers, fireplaces, etc.).
- If the extractor is used in conjunction with non-electrical appliances (e.g. gas burning appliances), a sufficient degree of aeration must be guaranteed in the room in order to prevent the backflow of exhaust gas. The kitchen must have an opening communicating directly with the open air in order to guarantee the entry of clean air.

## USE

- The extractor hood has been designed exclusively for domestic use to eliminate kitchen smells.
- Never use the hood for purposes other than for which it has been designed.
- Never leave high naked flames under the hood when it is in operation.
- Adjust the flame intensity to direct it onto the bottom of the pan only, making sure that it does not engulf the sides.
- Deep fat fryers must be continuously monitored during use: overheated oil can burst into flames.
- Do not flambè under the range hood; risk of fire
- This appliance is not intended for use by persons (including children) with reduced physical, sensory or mental capabilities, or lack of experience and knowledge, unless they have been given supervision or instruction concerning use of the appliance by a person responsible for their safety.
- Children should be supervised to ensure that they do not play with the appliance.

## MAINTENANCE

- Switch off or unplug the appliance from the mains supply before carrying out any maintenance work.
- Clean and/or replace the Filters after the specified time period (Fire hazard).
- Clean the hood using a damp cloth and a neutral liquid detergent.

The symbol  on the product or on its packaging indicates that this product may not be treated as household waste. Instead it shall be handed over to the applicable collection point for the recycling of electrical and electronic equipment. By ensuring this product is disposed of correctly, you will help prevent potential negative consequences for the environment and human health, which could otherwise be caused by inappropriate waste handling of this product. For more detailed information about recycling of this product, please contact your local city office, your household waste disposal service or the shop where you purchased the product.

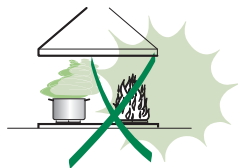
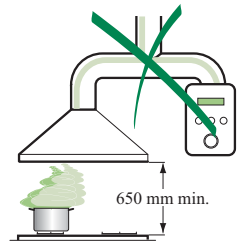

# CHARACTERISTICS

## Dimensions

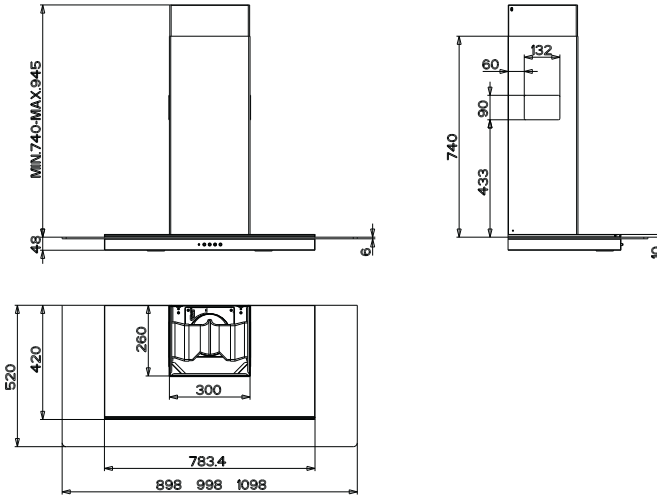

### Components

Ref.	Q.ty	Product Components
1	1	Hood Body, complete with: Controls, Light, Blower, Filters
2	1	Telescopic Chimney comprising:
2.1	1	Upper Section
2.2	1	Lower Section
8a	1	Right Air Outlet Grill
8b	1	Left Air Outlet Grill
9	1	Reducer Flange $\varnothing$ 150-120 mm
10	1	Adapting ring $\varnothing$ 120-125 mm
14	1	Hood Body Air Outlet Extension Piece consisting of two Half Shells
14.1	2	Air Outlet Connection Extension
15	1	Air Outlet Connection
Ref.	Q.ty	Installation Components
7.2.1	2	Upper Chimney Section Fixing Brackets
11	6	Wall Plugs
12a	6	Screws 4,2 x 44,4
12c	6	Screws 2,9 x 9,5
Q.ty	Documentation	
1	Instruction Manual	

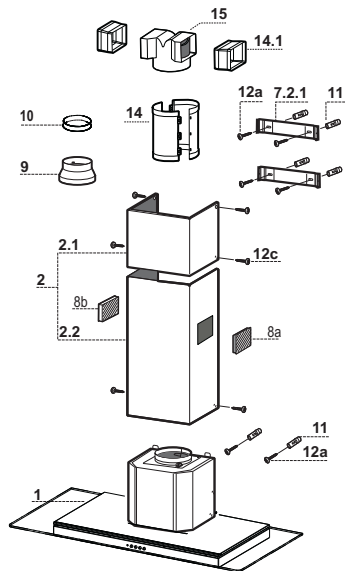

# INSTALLATION

## Wall drilling and bracket fixing

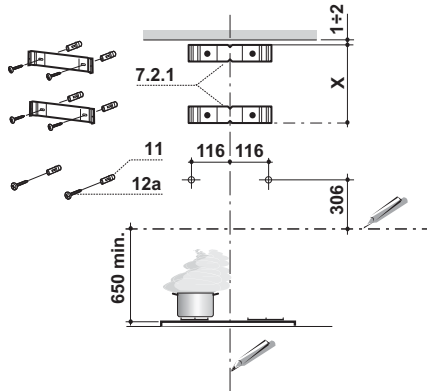

### Wall marking:

- Draw a vertical line on the supporting wall up to the ceiling, or as high as practical, at the centre of the area in which the hood will be installed.
- Draw a horizontal line at 650 mm above the hob. Place bracket **7.2.1** on the wall as shown about 1-2 mm from the ceiling or upper limit aligning the centre (notch) with the vertical reference line.
- Mark the wall at the centres of the holes in the bracket.
- Place bracket **7.2.1** on the wall as shown at X mm below the first bracket (X = height of the upper chimney section supplied), aligning the centre (notch) with the vertical line.
- Mark the wall at the centres of the holes in the bracket.
- Mark a reference point as indicated at 116 mm from the vertical reference line and 306 mm above the horizontal reference line.
- Repeat this operation on the other side.
- Drill  $\varnothing$  8 mm holes at all the centre points marked.
- Insert the wall plugs **11** in the holes.
- Fix the brackets using the **12a** (4,2 x 44,4) screws supplied.
- Insert the two screws **12a** (4,2 x 44,4) supplied in the hood body fixing holes, leaving a gap of 5-6 mm between the wall and the head of the screw.

## Mounting the hood body

- Before attaching the hood body, tighten the two screws **Vr** located on the hood body mounting points.
- Hook the hood body onto the screws **12a**.
- Fully tighten the support screws **12a**.
- Adjust the screws **Vr** to level the hood body.

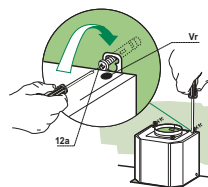

## Connections

### DUCTED VERSION AIR EXHAUST SYSTEM

When installing the ducted version, connect the hood to the chimney using either a flexible or rigid pipe  $\varnothing$  150 or 125 mm, the choice of which is left to the installer.

- To install a  $\varnothing$  125 mm air exhaust connection, insert the reducer flange **9** on the hood body air outlet and the adapting ring  $\varnothing$ 120-125 **10** on the reducer flange.
- Fix the pipe in position using sufficient pipe clamps (not supplied).
- Remove any activated charcoal filters.

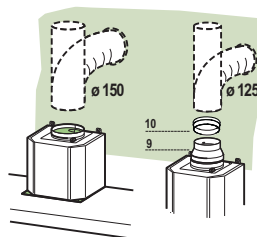

### RECIRCULATION VERSION AIR OUTLET

- Assemble the two halves of the hood body extension piece **14**.
- Push fit the assembled hood body extension piece **14** onto the air outlet.
- Push fit connection **15** onto the hood body extension piece **14**.
- Insert the connection extension pieces laterally **14.1** in connection **15**.
- Make sure that the outlet of the extension pieces **14.1** is horizontally and vertically aligned with the chimney outlets. If this is not the case, adjust the position by either reversing the connection extension pieces **14.1** or by cutting the hood body extension pieces **14** along one of the thinner section channels denoting the pre-fixed lengths, then reassemble as described previously.
- The air outlet directional grills **8a** - **8b** must be fitted after the lower outlet duct has been installed.
- Ensure that the activated charcoal filters have been inserted.

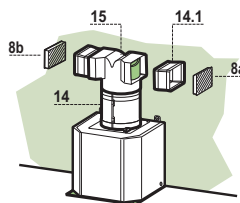

## ELECTRICAL CONNECTION

- Connect the hood to the mains through a two-pole switch having a contact gap of at least 3 mm.
- Remove the grease filters (see paragraph Maintenance) being sure that the connector of the feeding cable is correctly inserted in the socket placed on the side of the fan.

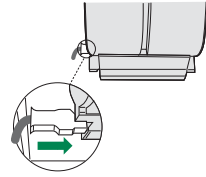

## Flue assembly

### Upper exhaust flue

- Slightly widen the two sides of the upper flue and hook them behind the brackets **7.2.1**, making sure that they are well seated.
- Secure the sides to the brackets using the 4 screws **12c** (2,9 x 9,5) supplied.

### Lower exhaust flue

- Slightly widen the two sides of the flue and hook them between the upper flue and the wall, making sure that they are well seated.
- Fix the lower part laterally to the hood body using the 2 screws **12c** (2,9 x 9,5) supplied.
- On the recirculation version, fit the directional grids **8a** – **8b** in their housings making sure that the directional symbols are towards the top and front of the hood. Also make sure that they are correctly inserted in the connection extension pieces **14.1**.

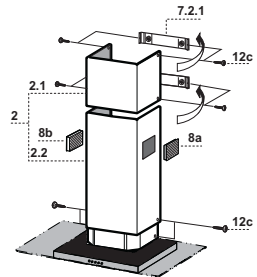

# USE

---

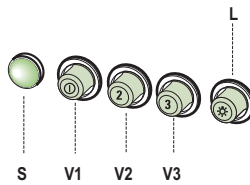

<b>L</b>	Light	Switches the lighting system on and off.
<b>S</b>	Led	Motor running led.
<b>V1</b>	Motor	Switches the extractor motor on and off at low speed. Used to provide a continuous and silent air change in the presence of light cooking vapours.
<b>V2</b>	Speed	Medium speed, suitable for most operating conditions given the optimum treated air flow/noise level ratio.
<b>V3</b>	Speed	Maximum speed, used for eliminating the highest cooking vapour emission, including long periods.



# MAINTENANCE

---

## Grease filters

---

### CLEANING METAL SELF-SUPPORTING GREASE FILTERS

- The filters must be cleaned every 2 months of operation, or more frequently for particularly heavy usage, and can be washed in a dishwasher.
- Remove the filters one at a time by pushing them towards the back of the group and pulling down at the same time.
- Wash the filters, taking care not to bend them. Allow them to dry before refitting.
- When refitting the filters, make sure that the handle is visible on the outside.

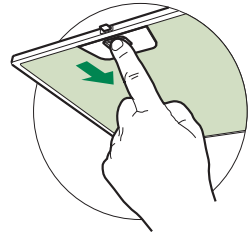

### Activated charcoal filter (Recirculation version)

---

#### REPLACING THE ACTIVATED CHARCOAL FILTER

- The filter is not washable and cannot be regenerated, and must be replaced approximately every 4 months of operation, or more frequently for particularly heavy usage.
- Remove the metal grease filters.
- Remove the saturated activated carbon filter by releasing the fixing hooks.
- Fit the new filter by hooking it into its seating.
- Refit the metal grease filters.

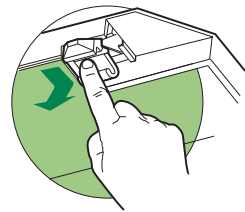

## Lighting

---

### LIGHT REPLACEMENT

#### 20 W halogen light.

- Remove the snap-on lamp cover by levering it from under the metal ring, supporting it with one hand.
- Remove the halogen lamp from the lamp holder by pulling gently.
- Replace the lamp with a new one of the same type, making sure that you insert the two pins properly into the housings on the lamp holder.
- Replace the snap-on lamp cover.

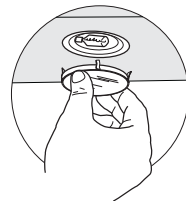







# RANGEmaster

Clarence Street, Royal Leamington Spa,  
Warwickshire, CV31 2AD, England.

Tel: +44 (0) 1926 457400 Fax: +44 (0) 1926 450526

E-mail: [consumers@rangemaster.co.uk](mailto:consumers@rangemaster.co.uk)

[www.rangemaster.co.uk](http://www.rangemaster.co.uk)

**AGA RANGEMASTER GROUP PLC**